

Received XX Month, XXXX; revised XX Month, XXXX; accepted XX Month, XXXX; Date of publication XX Month, XXXX; date of current version XX Month, XXXX.

Digital Object Identifier 10.1109/OJPEL.2022.0817315

MagNet Challenge for Data-Driven Power Magnetics Modeling

Minjie Chen¹, Haoran Li¹, Shukai Wang¹, Thomas Guillod², Diego Serrano¹, Nikolas Förster³, Wilhelm Kirchgässner³, Till Piepenbrock³, Oliver Schweins³, Oliver Wallscheid³, Qiujie Huang⁴, Yang Li²⁰, Yu Dou²¹, Bo Li²¹, Sinan Li⁴, Emmanuel Havugimana⁵, Vivek Thomas Chacko⁵, Sritharini Radhakrishnan⁵, Mike Ranjram⁵, Bailey Sauter⁶, Skye Reese⁶, Shivangi Sinha⁷, Lizhong Zhang⁷, Tom McKeague⁷, Binyu Cui⁷, Navid Rasekh⁷, Jun Wang⁷, Song Liu⁷, Alfonso Martinez⁸, Xinyu Liu⁹, Chaoying Mei⁹, Rui Zhao⁹, Gaoyuan Wu⁹, Hao Wu⁹, Rui Zhang¹⁰, Hao Song¹⁰, Lie Zhang¹⁰, Yibo Lu¹⁰, Lijun Hang¹⁰, Neha Rajput¹¹, Himanshu Bhusan Sandhibigraha¹¹, Neeraj Agrawal¹¹, Vishnu Mahadeva Iyer¹¹, Xiaobing Shen¹², Fanghao Tian¹², Qingcheng Sui¹², Jiaze Kong¹², Wilmar Martinez¹², Asier Arruti¹³, Borja Alberdi¹³, Anartz Agote¹³, Iosu Aizpuru¹³, Minmin Zhang¹⁴, Xia Chen¹⁴, Yuchen Dong¹⁴, Duo Wang¹⁴, Tianming Shen¹⁴, Yan Zhou¹⁴, Yaohua Li¹⁵, Sicheng Wang¹⁵, Yue Wu¹⁵, Yongbin Jiang¹⁵, Ziheng Xiao¹⁵, Yi Tang¹⁵, Yun-Shan Hsieh¹⁶, Jian-De Li¹⁶, Li-Chen Yu¹⁶, Tzu-Chieh Hsu¹⁶, Yu-Chen Liu¹⁶, Chin-Hsien Hsia¹⁶, Chen Chen¹⁶, Alessio Giuffrida¹⁷, Nicolo Lombardo¹⁷, Fabio Marmello¹⁷, Simone Morra¹⁷, Marco Pasquale¹⁷, Luigi Solimene¹⁷, Carlo Stefano Ragusa¹⁷, Jacob Reynvaan¹⁸, Martin Stoiber¹⁸, Chengbo Li¹⁹, Wei Qin¹⁹, Xiang Ma¹⁹, Boyu Zhang¹⁹, Zheng Wang¹⁹, Ming Cheng²⁰, Wei Xu¹⁹, Jiayao Wang¹⁹, Youkang Hu¹⁹, Jing Xu¹⁹, Zhongqi Shi¹⁹, Dixant Bikal Sapkota²², Puskar Neupane²², Mecon Joshi²², Shahabuddin Khan²², Bowen Su²⁰, Yunhao Xiao²⁰, Min Yang²⁰, Kai Sun²⁰, Zhengzhao Li²³, Reza Mirzadarani²³, Ruijun Liu²³, Lu Wang²³, Tianming Luo²³, Dingsihao Lyu²³, Mohamad Ghaffarian Niasar²³, Zian Qin²³, Syed Irfan Ali Meerza²⁴, Kody Froehle²⁴, Han Helen Cui²⁴, Daniel Costinett²⁴, Jian Liu²⁴, Zhanlei Liu²⁵, Cao Zhan²⁵, Yongliang Dang²⁵, Yukun Zhang²⁵, Na Wang²⁵, Yiting Chen²⁵, Yiming Zhang²⁵, Chushan Li²⁵, Yinan Yao²⁶, Tianxiang Hu²⁶, Lumeng Xu²⁶, Yiyi Wang²⁶, Sichen Wang²⁶, Shuai Jiang²⁷, David Shumacher²⁸, Dragan Maksimović⁶, Ron S. Y. Hui²⁹, Johann W. Kolar³⁰, David J. Perreault³¹ AND Charles R. Sullivan²

¹Princeton University, Princeton NJ, USA

²Dartmouth College, Hanover NH, USA

³Paderborn University, Paderborn, Germany

⁴University of Sydney, Sydney, Australia

⁵Arizona State University, Tempe, AZ, USA

⁶University of Colorado, Boulder CO, USA

⁷University of Bristol, Bristol, UK

⁸Würth Elektronik, Germany

⁹Fuzhou University, Fuzhou, China

¹⁰Hangzhou Dianzi University, Hangzhou, China

¹¹Indian Institute of Science, Bengaluru, Karnataka, India

¹²Katholieke Universiteit Leuven, Leuven, Belgium

¹³Mondragon University, Arrasate, Gipuzkoa, Spain

¹⁴Nanjing University of Posts and Telecommunications, Nanjing, China

¹⁵Nanyang Technology University, Singapore

¹⁶National Taipei University of Technology, Taipei City, Taiwan

¹⁷Politecnico di Torino, Torino, Italy

¹⁸Silicon Austria Labs, Graz, Austria

¹⁹Southeast University, Nanjing, China

²⁰Tsinghua University, Beijing, China

²¹Hebei University of Technology, Hebei, China

²²Tribhuvan University, Pulchowk Campus, Nepal

²³Delft University of Technology, Delft, The Netherlands

²⁴University of Tennessee, Knoxville, TN, USA

²⁵Xi'an Jiaotong University, Xi'an, China

²⁶ZJU-UIUC Institute, Zhejiang, China

²⁷Google Inc., Mountain View CA, USA

²⁸Enphase Energy, Austin TX, USA

²⁹University of Hong Kong, Hong Kong, China

³⁰Swiss Federal Institute of Technology, Zürich, Switzerland

³¹Massachusetts Institute of Technology, Cambridge MA, USA

*** All authors contributed equally to this paper. ***

CORRESPONDING AUTHOR: Minjie Chen (e-mail: minjie@princeton.edu), Charles R. Sullivan (e-mail: charles.r.sullivan@dartmouth.edu).

ABSTRACT

This paper summarizes the main results and contributions of the MagNet Challenge 2023, an open-source research initiative for data-driven modeling of power magnetic materials. The MagNet Challenge has (1) advanced the state-of-the-art in power magnetics modeling; (2) set up examples for fostering an open-source and transparent research community; (3) developed useful guidelines and practical rules for conducting data-driven research in power electronics; and (4) provided a fair performance benchmark leading to insights on the most promising future research directions. The competition yielded a collection of publicly disclosed software algorithms and tools designed to capture the distinct loss characteristics of power magnetic materials, which are mostly open-sourced. We have attempted to bridge power electronics domain knowledge with state-of-the-art advancements in artificial intelligence, machine learning, pattern recognition, and signal processing. The MagNet Challenge has greatly improved the accuracy and reduced the size of data-driven power magnetic material models. The models and tools created for various materials were meticulously documented and shared within the broader power electronics community.

KEYWORDS

Open-Source, Data-Driven Methods, Machine Learning, Artificial Intelligence, Power Magnetics, Power Ferrites

I. MAGNET CHALLENGE OVERVIEW

MAGNETIC components account for more than 30% of both the cost and losses in nearly all power converters [1], [2]. The performance of these magnetic components represents a significant bottleneck in advancing high-performance power electronics. Magnetic components are becoming increasingly sophisticated with different portions of the core excited by different waveforms [3]. Considerations include the impact of dc bias [4], geometry [5] and temperature [6]. Intricate winding structures change terminal impedance and current distribution [7]. Usually, these effects can only be captured as look-up tables or loss maps [8]–[10]. While circuit simulation tools have expedited integrated circuit design, and numerical field simulation tools have deepened our understanding of intricate component geometries, progress in modeling and simulating power magnetic material characteristics has been lagging.

Fundamentally, Maxwell’s equations can precisely describe the linear behavior of conductors at high frequencies. Finite element models have the potential to largely capture the geometry and thermal impact. The challenge lies in the highly nonlinear nature of magnetic materials and the considerable variation in magnetic component-level behaviors arising from the material properties and manufacturing processes [11]. Despite advancements in elucidating core loss phenomena [12]–[14], physical theories and lumped circuit models fall short in predicting core losses or B - H

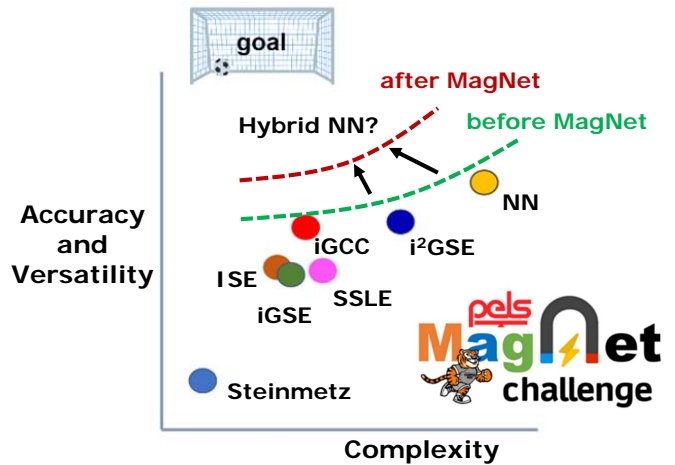

FIGURE 1. The vision and mission of the MagNet Challenge in 2023. The open-source initiative aims at developing less complex, more versatile, and more accurate data-driven power magnetics models.

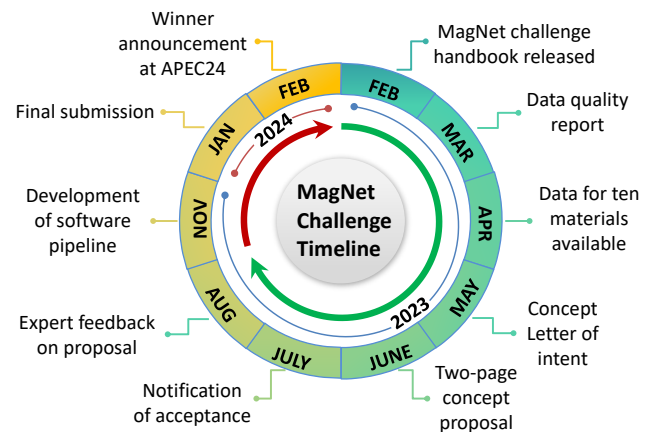

FIGURE 2. The 1-year timeline of the MagNet Challenge in 2023, spanning from February 2023 to February 2024.

loops with practical accuracy for real-world materials. Existing magnetic material modeling tools either oversimplify and lack accuracy, or rely on experimental measurements after design and fabrication. Power electronics design can be greatly advanced by a rapid and precise method for modeling the complex behaviors of magnetic materials, especially tools that can be integrated with circuit simulations or finite-element analysis for capturing non-linear effects.

A majority of commonly used methods of modeling core losses in power magnetics are based on the empirical Steinmetz equation (SE) [15]. Steinmetz parameters may vary dramatically across the magnetics operating range. As power loss increases, the temperature of magnetic materials also increases, which is not well captured in the Steinmetz modeling framework. Despite several modifications and upgrades to the original SE (e.g., MSE [16], NSE [17], ISE [18], SSLE [19], CWH [20], iGCC [21], iGSE [22], and i²GSE [23]) – usually by adding new parameters to the SE framework – these curve-fitting methods have limited

accuracy and cannot be smoothly expanded to cover more influences. Upgrading the Steinmetz modeling framework is a key step in advancing the design flow for power magnetics.

Another important task for describing power magnetic materials is to model the B - H loops [24]–[27]. As a material signature, the B - H loop can be used to extract the power loss, and can be used in analytical or numerical tools to analyze the behaviors of magnetic components, such as inductance variation, saturation, and coupling. Existing hysteresis modeling frameworks (e.g., the Preisach model [28] and the Jiles-Atherton model [29]) are generally developed based on semi-empirical equation-based methods. There are opportunities to upgrade the B - H modeling methods with modern neural network methods [30], [31], and to unify the modeling of core losses and B - H loops.

These contributions of MagNet Challenge include both advancing the technology and fostering a more collaborative research community in power electronics by:

- 1) **Advancing the state-of-the-art:** Through collaborative and competitive multi-objective optimization, the challenge has pushed the boundaries of what is possible in power magnetics modeling.
- 2) **Developing guidelines for data-driven research:** The challenge has established practical rules and useful guidelines for conducting data-driven research in power electronics.
- 3) **Fostering an open-source research community:** It has set examples for creating a transparent, open-source international research community, promoting collaboration on key topics.
- 4) **Exploring future research directions:** By providing a fair performance benchmark, it offers new insights that can guide future research in power magnetics modeling towards the most promising approaches.

A. MagNet Challenge Motivations

“It’s time to upgrade the Steinmetz equation!” – the Steinmetz equation (SE) is an empirical equation used to calculate the power loss (typically referred to as core loss) per unit volume in magnetic materials when subjected to external sinusoidal magnetic flux. The earliest version was proposed by Charles Steinmetz in the 1890s [32], [33]. Typically, the SE is written as:

$$P_v = k \times f_{sw}^a \times B_{ac}^b, \quad (1)$$

where P_v is the time average power loss per unit volume (e.g., in mW/cm³), f_{sw} is the frequency (e.g., in kHz), and B_{ac} is the peak ac magnetic flux density (e.g., in mT); and k , a , and b , known as the Steinmetz coefficients or Steinmetz parameters, are generally found empirically from the material’s B - H hysteresis curve by curve fitting. One of the most popular upgrades to the Steinmetz equation is the improved generalized Steinmetz equation [22], often referred to as iGSE, which estimates losses with any flux waveform using only the parameters needed for the original equation.

The iGSE can be expressed as:

$$P_v = \frac{1}{T} \int_0^T k_i \left| \frac{dB}{dt} \right|^a (\Delta B^{b-a}) dt. \quad (2)$$

Here, ΔB is the peak-to-peak flux density swing, and k_i is defined by

$$k_i = \frac{k}{(2\pi)^{a-1} \int_0^{2\pi} |\cos \theta|^a 2^{b-a} d\theta} \quad (3)$$

while a , b , and k are the same coefficients used in the original Steinmetz equation. The iGSE is widely used in practice because most other models require parameters that are not usually given by manufacturers. The i²GSE method [23] improves upon the iGSE by adding five more parameters to the original three Steinmetz parameters to achieve higher accuracy. In practice, these parameters are not widely available from manufacturers, leaving the designer to collect them. Even so, describing the complex behaviors of typical power magnetic materials with only eight parameters is often insufficient to offer the desired accuracy for precise magnetics modeling. The different methods of finding the Steinmetz parameters add uncertainty to the modeling accuracy. They also do not capture the impact of flux dc bias and temperature.

The MagNet Challenge, modeled after the ImageNet Challenge organized by the computer vision community [34], aimed to create an open-source community in power electronics and upgrade the existing Steinmetz equation-based core loss modeling framework with the support of a massive amount of high-quality measurement data covering different materials across a wide range of frequencies, waveform shapes, and temperatures. As illustrated in Fig. 1, a modeling framework that can better leverage modern data-driven methods to improve the model accuracy, model versatility, and to reduce the model size was the goal of MagNet Challenge. We seek data-efficient, computing-efficient, memory-efficient, and scalable algorithms to develop new tools and advance the understanding of magnetic core characteristics, including core losses and B - H loops. The key questions we tried to answer when designing the challenge rules included the following:

- Shall we use **one uniform modeling framework (e.g., the SE framework), or many different modeling frameworks** to cover a wide range of materials for different purposes?
- **What accuracy is sufficient** for power magnetics modeling, considering sample-to-sample variation, geometry uncertainty, temperature variation, dc bias, and other manufacturing and operating conditions? How much error comes from materials and how much error comes from measurements?
- **What is the minimum number of parameters** a model needs to include to describe a particular power magnetic material with satisfactory accuracy across a wide operation range?

TABLE 1. MagNet-related GitHub Repository.

Project	GitHub Repository
MagNet Challenge	https://github.com/minjiechen/magnetchallenge
MagNet AI & Data	https://github.com/PrincetonUniversity/magnet
MagNet Toolkit	https://github.com/upb-lea/mag-net-hub
MagNet Engine	https://github.com/moetomg/magnet-engine

- **What is the best framework** for modeling power magnetics considering different design goals (e.g., for core loss modeling, $B-H$ loop modeling, hand calculation, SPICE simulation, or finite element analysis)?
- How can we visualize the data and develop explainable data-driven models to **advance the physical understanding** of power magnetic materials?
- **How much data do we need** to train a good magnetic material model across a wide operation range? How to sample the operation space and reduce the dimension?

These are just a few example questions that one may ask when developing a new framework for modeling power magnetic material characteristics. To answer these questions, we designed the following three competition tracks:

- **Model Performance Track:** Develop a systematic approach to learn from a large amount of existing data for pre-existing materials, and apply this approach to model similar and different new materials with new data, and make accurate predictions.
- **Concept Novelty Track:** Develop new concepts for power magnetic core loss and $B-H$ loop modeling, including but not limited to fundamental physical mechanisms and hypotheses, as well as data and signal processing methods, tools, and algorithms.
- **Software Engineering Track:** Develop software tools and systems with high readability, reusability, versatility for open-source development, and enhanced human-computer interface (HCI) for rapid design iterations.

The focus of the MagNet Challenge in 2023 was to model core loss in periodic steady state. $B-H$ loops were provided as training data. Other related topics, such as modeling transient dynamics of magnetic components, and predicting $B-H$ loops, were beyond the scope of the MagNet Challenge in 2023 but may be included in future competitions.

The MagNet Challenge reviews and compares existing and new methods through an open-source competition. The goal is both to advance technology and to foster a more collaborative research community. Instead of looking back into existing literature, a forward-looking platform was created to thoroughly compare the strengths and weaknesses of existing and newly developed technical methods under uniform rules.

By participating in the MagNet Challenge, all teams enter the above three tracks and competed on model performance, size, and software engineering. Figure 2 shows the timeline of the MagNet Challenge in 2023. MagNet Challenge at-

TABLE 2. Sizes of the training and testing datasets for the 10 materials used in competition round #1.

Material	3C90	3C94	3E6	3F4	77
Training	40713	40068	6996	6564	11444
Testing	5000	5000	5000	5000	5000

Material	78	N27	N30	N49	N87
Training	11380	11396	8978	8602	40616
Testing	5000	5000	5000	5000	5000

† Each data point represents the measured $B-H$ loop information at a particular operating point.

‡ Three different types of excitation (sinusoidal, triangle, and trapezoidal) are included for each material in both the training and testing sets.

tracted more than 220 international researchers to advance this important topic together as competition participants, judges, organizers, and volunteers. By submitting the developed code, reports, and models to the MagNet Challenge, the intellectual property was disclosed to the public.

Table 1 lists the key MagNet-related GitHub repositories. The competition handbook, tutorials, supporting documents, training and test datasets, final submitted reports, presentation slides, meeting recordings, and the submitted models can be found at the GitHub repository of the MagNet Challenge. The MagNet AI & Data repository contains the raw data and related data visualization tools maintained by **Princeton University**. Other repositories include the 1) MagNet Toolkit developed by **Paderborn University** as a hub for selected power loss models that were elaborated by different competitors during the MagNet Challenge; and 2) MagNet Engine developed by **University of Sydney** as a user-friendly graphical user interface (GUI) for modeling magnetic core losses in power electronics.

B. MagNet Challenge Rules and Data Preparation

The goal of the MagNet Challenge in 2023 is to develop intelligent software tools that can learn and predict core loss information with efficient data usage. For each magnetic material of interest, student teams were asked to develop a MATLAB or Python function that takes the following three inputs for modeling power magnetic materials in steady state:

- A single-cycle arbitrary flux density waveform in 1024 steps: $B(t)$ (unit: T).
- An operation frequency: f_{sw} (unit: Hz).
- A temperature: T (unit: degrees C).

and produce the following output:

- An average volumetric core loss estimation (floating point): P_v (unit: W/m^3).

Measurement data with dc bias was made available in the MagNet database [4]. However, due to the lack of sufficient high quality data and a clear understanding of the measure-

TABLE 3. Sizes of the training and testing datasets for the 5 materials used in competition round #2.

Material	3C92	T37	3C95	79	ML95S
Training	2432	7400	5357	580	2013
Testing	7651	3172	5357	7299	3738

† The training and testing datasets were strategically sampled in particular ways to examine the model performance from different angles.

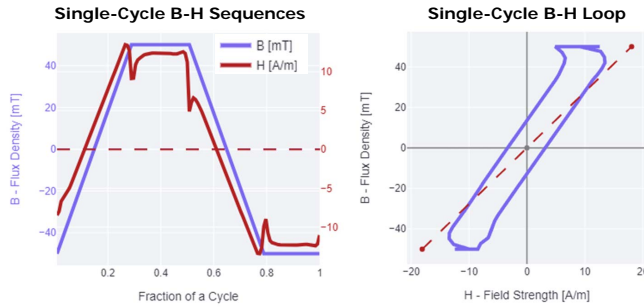

FIGURE 3. An example data sample offered in the MagNet Challenge. This data point describes the B - H loop of N87 material operating at 25°C, 200 kHz, and zero dc bias under a trapezoidal excitation. The volumetric core loss is 113.64 kW/m³ under zero dc bias. Over 2,000,000 data points like this are available in the MagNet database for 15 different materials.

ment accuracy, dc bias [4], [35] and geometry impact [5] were not included in the MagNet Challenge in 2023. Student teams were encouraged to consider dc bias information, which may be included in future competitions.

Figure 3 shows an example data point used in the MagNet Challenge. Each raw data point is a measured B - H loop describing the characteristics of a power magnetic material used in an experimental scenario. The capacitive effect of the core materials, as well as the winding to core parasitic capacitance are captured in the measurements. The training data includes the B - H loop time sequences, frequency f_{sw} , and temperature T . The final outcome of the model is a callable function:

$$P_v = f(B(t), f_{sw}, T). \quad (4)$$

The data used for the MagNet Challenge comes from the Princeton-Dartmouth MagNet Project [11], [30], [31]. The challenge included two rounds of competitions: a pre-test round which allowed the teams to get familiar with the data and the competition rules, and a final-test round which determined the teams' final ranking. Each training data point is offered as a pair of single-cycle $B(t)$ and $H(t)$ time sequences, with 1024 steps at different frequencies f_{sw} and temperatures T . The area of the B - H loop determines the volumetric core loss P_v . Note that different numerical integration algorithms for calculating the B - H loop areas may result in very different core loss estimation results, especially if the B - H curve is not smooth (e.g., due to non-sinusoidal excitation or nonlinear material behavior). The

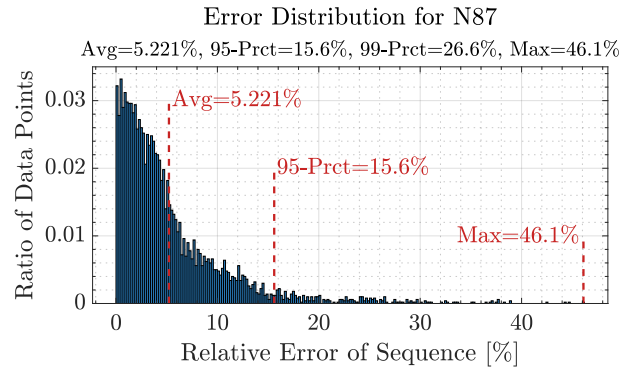

FIGURE 4. Histogram of the prediction error of an example model, together with labeled average, 95th percentile error, and maximum error.

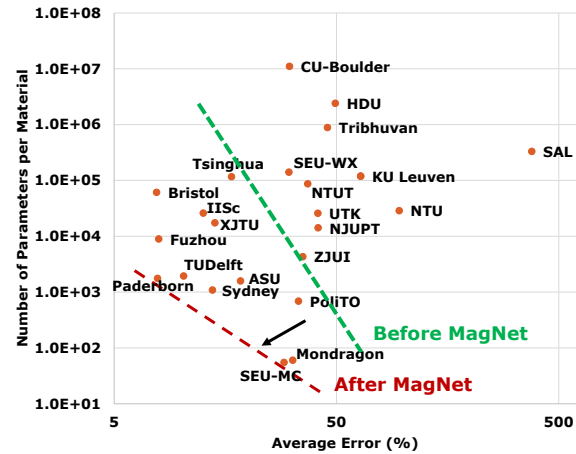

FIGURE 5. Average 95th percentile error across the 5 materials, and average model number of parameters (size) of the 24 final submissions, together with the state-of-the-art (SOTA) Pareto fronts before and after the MagNet Challenge, estimated using the results reported in [30] as a benchmark. The minimum average 95th percentile error reaches 7%, and the smallest model parameter size reaches 60. Both the model sizes and average errors are greatly reduced as a result of the community effort in the MagNet Challenge.

testing data points include $B(t)$, f_{sw} , and T , but do not include $H(t)$ or P_v . The datasets used for the pre-test phase and the final-test phase were:

- Round #1 Training: A large amount of training data for 10 materials dedicated for training: {3C90, 3C94, 3E6, 3F4, 77, 78, N27, N30, N49, N87}.
- Round #1 Testing: Separate, randomly sampled testing data for the same 10 materials: {3C90, 3C94, 3E6, 3F4, 77, 78, N27, N30, N49, N87}.
- Round #2 Training: Strategically sampled training data for 5 materials: {3C92, T37, 3C95, 79, ML95S}.
- Round #2 Testing: The remaining data for the same 5 materials used in Round #2 training: {3C92, T37, 3C95, 79, ML95S}.

Tables 2-3 list the size of the dataset made available for each material. As documented in [11], [30], the MagNet dataset covers a fundamental frequency range from 50 kHz

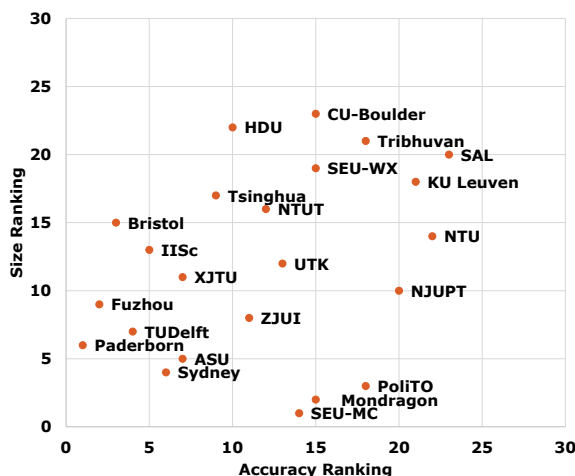

FIGURE 6. Model accuracy and model size ranking of the 24 teams that qualified for the final competition. Note that the differences in the model accuracy are usually very small among the best performing teams, whereas the differences in model size are often very large.

to 500 kHz, and a flux density range from 10 mT to 300 mT, with sinusoidal, triangular, and trapezoidal waveforms. The waveforms were collected assuming the magnetic components are utilized in a real power converter (i.e., a “T” type circuit in [11]). The data acquisition process was fully automated to enable systematic error analysis and ensure high measurement repeatability. The frequency and flux density limits were carefully selected to ensure high-enough data quality. Although the MagNet Challenge focuses on material-level characteristic model of ferrite materials, similar methods and data can be used to advance component-level models and to model non-ferrite materials.

The accuracy of a data-driven model is always bounded by the accuracy of the measurements. One can improve the accuracy of a data-driven model by increasing the number of parameters in the model, however, the chance of model overfitting can significantly increase if the model accuracy is higher than the measurement accuracy. A deep understanding of the modeling error and measurement error enables a good balance between model accuracy and model size. In the MagNet Challenge, the maximum measurement error is generally controlled below 20% across the full operation range [11], with an average error below 10%. As a result, we encouraged the participating teams to target an average model error of around 10%, and try to minimize the number of model parameters.

The names of the materials used in the round #2 competition were kept confidential to ensure competition fairness. The datasets for the 5 materials used in the round #2 competition were strategically sampled to test the model performance in 5 different ways:

- **3C92** (Material A) is a material that looks very similar to the 10 materials available in the first round training set. It was used to set up a “tiny data challenge”, in

which only a small dataset was offered for training, and a large dataset was reserved for testing.

- **T37** (Material B) is a broadband material, which looks fairly different from the 10 materials available in the previous training set. It was used to set up a “new material challenge”, in which a large dataset was offered for training, and a small dataset was reserved for testing.
- **3C95** (Material C) is a material used for testing temperature dependence. It was used to set up a “temperature challenge”, in which the testing dataset includes temperatures that were not covered in the training dataset.
- **79** (Material D) is a material used for testing waveform dependence. It was used to set up a “waveform challenge”, in which the training set has only very limited data points for trapezoidal-waveform excitation, while the testing set has many data points for trapezoidal waveforms.
- **ML95S** (Material E) is a material used for testing frequency and flux density dependence. It was used to set up a “frequency and flux density challenge”, in which the training set has very limited data points for a few frequency and flux density operating points, while the testing set has lots of data points not covered in the training set.

MagNet Challenge focused on core loss prediction. The absolute value of the relative error ϵ of the core loss prediction is defined as:

$$\epsilon = \frac{|P_{v,\text{meas}} - P_{v,\text{pred}}|}{P_{v,\text{meas}}} \times 100\%. \quad (5)$$

Here $P_{v,\text{meas}}$ is the measured volumetric core loss, $P_{v,\text{pred}}$ is the predicted volumetric core loss. The histogram of ϵ for each material is then plotted with the average, the 95th and 99th percentile, and the maximum errors labeled as in Fig. 4. The 95% percentile error was used to rank the accuracy of different models. Based on our evaluation of sample-to-sample variation of power magnetic components [11], we anticipate a 95th percentile error of less than 10% as being competitive for magnetic core loss modeling¹.

It is important to quantify the model size. We define the model size as the total number of parameters that a model needs to store to describe the characteristics of each material. The complexity of algorithms, such as model structure, iteration loops, layers of neuron networks, etc., are not considered in counting the number of parameters. MagNet Challenge was designed to encourage models with more computation and less memory usage.

¹The normalization in (5) might have lead towards a data bias overemphasizing samples with very low absolute losses since the estimation error (numerator) typically does not scale linearly with the target value (denominator). The extremes of operating points with very low losses (where loss may be negligible) and very high losses (where operation is impractical) may be of less interest in practical magnetic component design work for power electronics, so alternative performance metrics might be considered in future challenges.

C. MagNet Challenge Final Results

In April 2023, 39 teams from 17 countries registered for the MagNet Challenge. 24 teams from 17 countries continued through the end and submitted their final results. A complete list of the participating teams in the two rounds of competition is provided in the Appendix.

Developing a good data-driven power magnetics model is a multi-objective optimization process. Pooling the individual research outcomes together visualizes the Pareto front of the state-of-the-art and provides a fair performance benchmark and insightful outlook on future research directions. Figure 5 shows the average 95th percentile error and model size of the final submissions. The winning models use about 1,000 parameters to achieve less than 10% average 95th percentile error. Fig. 6 lists the accuracy ranking and size ranking of the 24 teams.

Table 4 provides a brief summary of the models and methods developed by the participating teams. Table 5 lists the 95th percentile error and size of the models developed by each team for each of the 5 testing materials.

II. MAGNET CHALLENGE RESEARCH FINDINGS

The MagNet Challenge offered an opportunity for student teams to explore a wide range of equation-based and data-driven methods for power magnetic material modeling, and the outcomes of the challenge quantitatively verified the fundamental tradeoff between model size and model accuracy. Most teams centered their strategy around modern machine learning methods. A few of them are focused on physics-based or equation-based methods. Evaluating a wide variety of different methods with a strategically designed database leads to a better understanding of the strengths and weaknesses of different strategies.

Note that the descriptions of these models are developed based on their performance and novelty ranking in the MagNet Challenge. Although the rules of the MagNet Challenge were carefully designed to reflect the opportunities and challenges in the real application scenario, a winning model in the MagNet Challenge may or may not perform well in real-world application scenarios. While we were able to rank different methods by different evaluation rules as a part of this competition, these methods are pending further improvements, and their rankings may be very different under different evaluation rules. Nevertheless, the performance and rankings reported in this paper can provide useful guidelines for further enhancement of these methods and the development of new methods.

Here we provide a brief review of many of the individual scientific papers recently published by the research teams participating in the challenge [36]–[45].

A. Grey-Box Hybrid Approach

One widely-adopted data-driven approach in the MagNet Challenge is the grey-box neural network approach, for its excellent capability of balancing model accuracy and

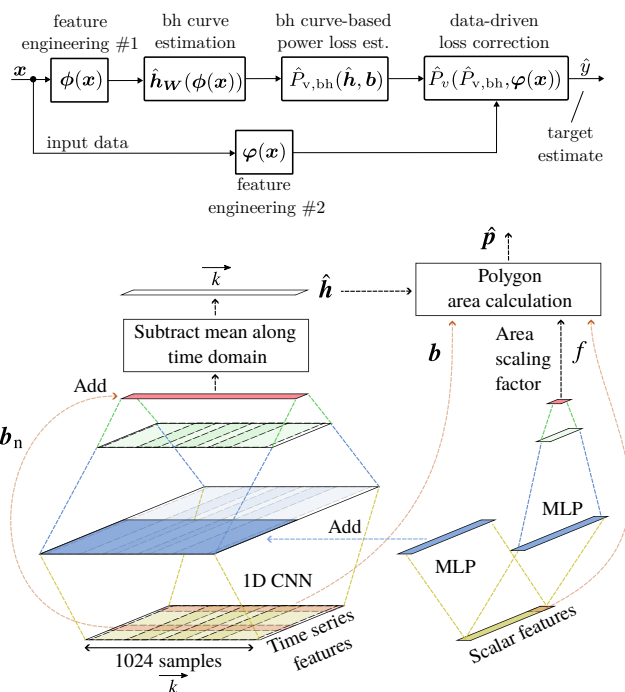

FIGURE 7. Overview of the HARDCORE architecture developed by Paderborn University, which leads to excellent model accuracy and compact model size.

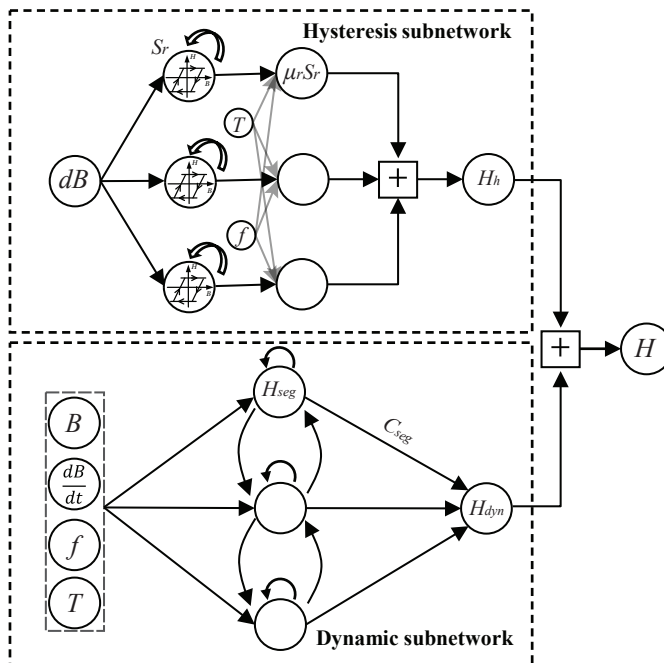

FIGURE 8. The MMINN architecture developed by University of Sydney.

model size. The neural network architectures are designed with guidelines from physical understanding and explainable logic. Figure 7 shows the HARDCORE architecture developed by Paderborn University [36]. The architecture starts from feature engineering on the $B(t)$ waveform, followed by a B – H loop estimation block implemented as a 1-D

TABLE 4. MagNet Challenge Methodology Summary.

Team Name	Method	Methodology Highlights
ASU	Black-Box Data-Driven	Model optimization guided by deep understanding about error and data size
Bristol	Black-Box Data-Driven	Systematic transfer learning, thorough data engineering and model optimization
Fuzhou	Black-Box Data-Driven	Systematic neural network exploration based on deep physical insights
HDU	Black-Box Data-Driven	Neural network implementation based on vision transformer approach
KU-Leuven	Black-Box Data-Driven	Exploration on generative adversarial neural network
NJUPT	Black-Box Data-Driven	Equation-based approach for smoothing loss maps
NTU	Black-Box Data-Driven	Vision transformer approach based on CNN
NTUT	Black-Box Data-Driven	Systematic neural network approach with automatic tuning of hyper-parameters
Tsinghua	Black-Box Data-Driven	Multi-Layer Perceptron (MLP) regression with Fast Fourier Transform
TU-Delft	Black-Box Data-Driven	Systematic neural network implementation and multi-objective optimization
UTK	Black-Box Data-Driven	GAN based data augmentation, attention based U-Net with linear conditioning
XJTU	Black-Box Data-Driven	Feature extraction with CNN, and sequence prediction with LSTM
CU-Boulder	Grey-Box Hybrid	Random forest regression with high data usage efficiency and low computing cost
IISc	Grey-Box Hybrid	Waveform classification and neural network development using learnable parameters
Paderborn	Grey-Box Hybrid	Residual CNN with physics-informed extensions (intermediate $B-H$ reconstruction layer)
PoliTO	Grey-Box Hybrid	Hybrid neural network model with equation based methods for trustworthy
SAL	Grey-Box Hybrid	Graph neuronal network (GNN) combined with symbolic regression (SR)
SEU-WX	Grey-Box Hybrid	Hybrid neural network model with physical insights
Sydney	Grey-Box Hybrid	Hybrid neural network model with physical insights, excellent software engineering
Tribhuvan	Grey-Box Hybrid	Fast fourier transform for signal pre-processing followed by LSTM
ZJUI	Grey-Box Hybrid	Neural network for loss prediction and iGSE for safety guarantee
Mondragon	White-Box Equation-Based	Fully automated multi-dimensional curve-fitting
SEU-MC	White-Box Equation-Based	Multi-dimensional curve-fitting with physical insights

convolutional neural network (CNN). The core loss predicted by the $B-H$ loop area calculation is then corrected by a data-driven model which produces the final prediction. This model is highly compact (with 1755 parameters) but also delivers very high prediction accuracy across all five testing materials.

The Magnetization Mechanism-Inspired Neural Network (MMINN) architecture developed by **University of Sydney** also achieved good balance between model size and model accuracy. MMINN is designed to capture the fundamental magnetization processes of magnetic materials at the microscopic level. As illustrated in Fig. 8, MMINN comprises two subnetworks for capturing hysteresis (i.e., the magnetization of magnetic domains) and dynamic (i.e., the eddy current of the core material owing to the electromagnetic induction) behaviors, and has the potential to be extended to capturing more complex dynamic core loss profiles when more data is available. The compact MMINN model only needs 1000 parameters and performed well on the accuracy test.

The model proposed by the team from **Politecnico di Torino** tried to apply different modeling methods to different excitation waveforms to minimize the model size. SVM regression was used to model losses with sinusoidal excitations and neural networks were used to model losses with triangular excitations. The composite waveform hypothesis

was then used to convert the results predicted by the neural network trained with triangle data for trapezoidal excitations.

The model presented by the team from the **Indian Institute of Science** followed a similar strategy of developing a neural network model tailored to each type of excitation. The loss function for training the neural networks comprised a data loss term, i.e., MSE (output of neural network – measured core loss), and an empirical loss term, i.e., MSE (output of neural network – empirical equation for core loss), where MSE (\cdot) is the mean-squared error. The team used the classical Steinmetz equation for sinusoidal excitations and the composite waveform hypothesis-based improved Steinmetz equations (ISE) [37] to compute the empirical loss term for triangular and trapezoidal excitations as seen in Fig. 10. In addition, the team incorporated the concept of learnable parameters to extract the unknown Steinmetz parameters. The model achieved very high accuracy on four materials (except 79) with a relatively large number of parameters.

The team from **University of Colorado Boulder** selected random forest regression as the core of their strategy [38]. Random forest algorithms prioritize rapid training and computation over parameter size as compared to other previously mentioned neural network methods. By leveraging the equation-based model as a starting point and attempting to only predict and correct the error, this method offers high

TABLE 5. MagNet Challenge final results: 95th percentile error and model size of the 24 teams qualified for the final competition.

Material	3C92 (Material A)		T37 (Material B)		3C95 (Material C)		79 (Material D)		ML95S (Material E)	
Team Name	% Error	# Size	% Error	# Size	% Error	# Size	% Error	# Size	% Error	# Size
ASU	9.6	1576	5.6	1576	8.5	1576	55.3	1576	13.5	1576
Bristol	8.5	90653	2	90653	4.5	90653	15.9	16449	8	16449
Fuzhou	4.9	8914	2.2	8914	2.9	8914	20.7	8914	9	8914
HDU	16	2396048	3.7	2396048	6.8	2396048	201.4	2396048	19.3	2396048
KU-Leuven	72.4	118785	58	118785	66.1	118785	71.3	118785	53.7	118785
NJUPT	45.9	9728	6.9	29600	26.4	21428	59.4	1740	68.4	8052
NTU	99.8	28564	88.7	28564	93.7	28564	99.3	28564	97.8	28564
NTUT	19.9	86728	7.4	86728	7.7	86728	65.9	86728	85.1	86728
Tsinghua	13.1	116061	6.4	116061	9.3	116061	29.9	116061	25.7	116061
TU-Delft	7.2	1419	1.9	2197	3.5	2197	29.6	1419	9.1	2454
UTK	15.6	23000	4.3	23000	9.3	23896	79.2	32546	98	25990
XJTU	12.4	17342	3.8	17342	10.7	17342	30	17342	14.1	17342
CU-Boulder	40.5	11012900	7.8	11012900	25.2	11012900	44.1	11012900	36.3	11012900
IISc	4.6	25923	2.8	25923	6.8	25923	39.5	25923	9.3	25923
Paderborn	4.8	1755	2.2	1755	3.4	1755	22.2	1755	6.6	1755
Polito	32.1	610	33.4	760	27.7	748	47.1	700	28.5	610
SAL	351.2	329537	138.7	329537	439.5	329537	810.1	329537	152.8	329537
SEU-WX	26.1	139938	12.9	139938	15.6	139938	79.1	139938	19.1	139938
Sydney	10	1084	3.7	1084	5	1084	30.7	1084	19.9	1084
Tribhuvan	24.5	1033729	8	1033729	8.9	1033729	67.9	276225	118.7	1033729
ZJUI	15.5	4285	6.1	4285	10.1	4285	67.9	4285	77	4285
Mondragon	21.3	60	7.9	60	14.4	60	93.9	60	21.5	60
SEU-MC	38.8	81	6.9	56	21	61	50.5	23	28.2	53

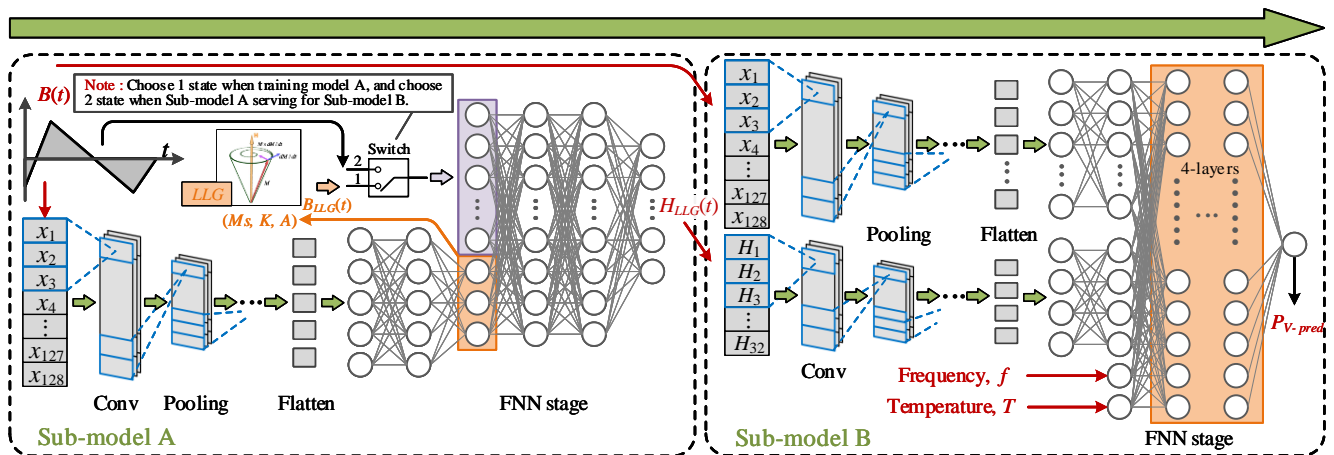

FIGURE 9. The two-stage PI-MFF-CN architecture developed by Southeast University SEU-WX.

data usage efficiency and low computation cost compared to other models.

The Southeast University SEU-WX team presented an interesting Physics-Inspired Multimodal Feature Fusion Cascaded Network (PI-MFF-CN), which was developed based on micromagnetism and the associated Landau-Lifshitz-Gilbert (LLG) equation, and is trained by embedding physical mechanisms in the gradient learning process of the

network. As shown in Fig. 9, a multimodal feature fusion method then combines the advantages of CNNs and fully connected neural networks (FCNNs) to learn mixed-sequence scale data. Although it did not rank high in the competition performance metrics, this method represents a deep exploration of hybrid data-driven and physics-based models.

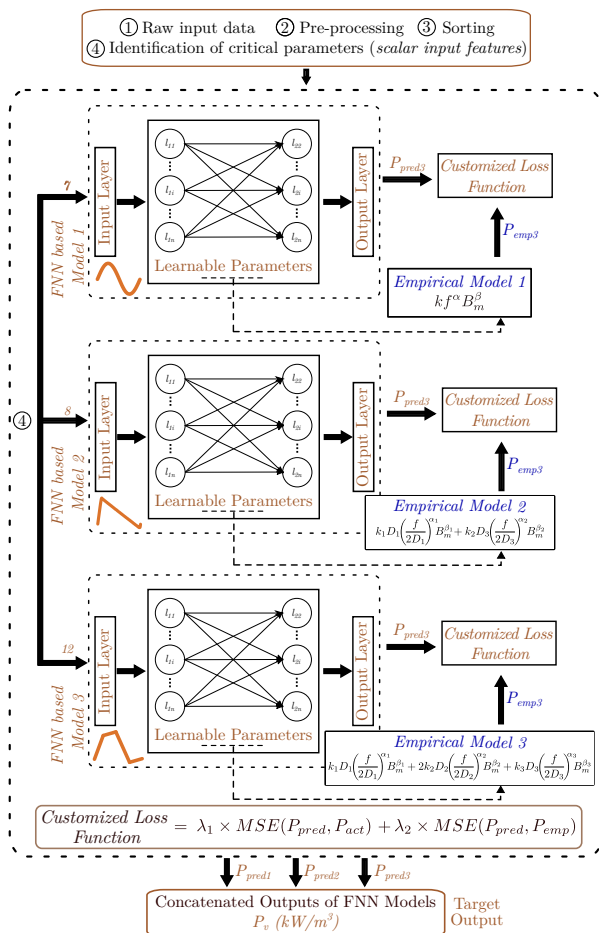

FIGURE 10. Empirical model informed neural network development using learnable parameters introduced by IISc team.

Silicon Austria Labs's model is on the boundary between gray-box model and black-box model. They trained a graph neural network (GNN) and utilized symbolic regression (SR) to develop a new formula for the magnetic core loss. However, the outcomes obtained from this approach were found to be unsatisfactory, primarily due to the structure of the problem. Ultimately, a NN combined with an FFT and some preprocessing techniques were utilized. FFT in combination with NN was also explored by the team from **Tribhuvan University** in [39]. The teams from **Nanjing University of Posts and Telecom** also explored equation based methods with novel insights and promising outcomes. **Zhejiang University-UIUC** explored a method which uses neural networks structured around the iGSE as a base model to accelerate the learning process and reduce the data requirement.

B. Black-Box Data-Driven Approach

The model developed by **Fuzhou University** fully exploited the potential of a sequence-to-scalar transformer architecture, together with a deep understanding of the data and the principles of core loss modeling. As can be seen in Fig. 11,

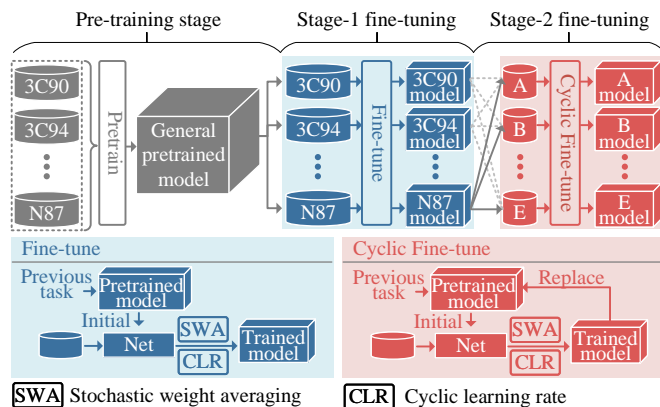

FIGURE 11. The multi-stage fine-tuning strategy introduced by Fuzhou University.

they introduced a multi-stage fine-tuning strategy to explore the process of knowledge transfer, thereby discovering a potential solution for a fundamental cross-material model, i.e., the “MagNet-GPT”, as further extended solutions for the principles presented in [31], [40], [41].

The **University of Bristol** team adopted a long-short-term-memory (LSTM) architecture to process the time sequences, followed by a Feedforward Neural Network (FNN) for merging frequency and temperature information. The outstanding model performance comes from the deep understanding and engineering practice on transfer learning. As illustrated in Fig. 12, the transfer learning process enables the model to achieve high performance even with very limited available data for a new power magnetic material. This model needed a lot of parameters, but achieved high performance across all five materials.

The **Delft University of Technology** team proposed an excellent strategy for multi-material transfer learning and model multi-objective optimization (MOO) [42]. As illustrated in Fig. 13, the MOO approach allows the model to precisely select the right parameter size to balance model size and accuracy. The optimization shows that a total number of 1,000 parameters is a good balance point between model size and accuracy, which was validated by the comparison to the winning models in the MagNet Challenge.

The **University of Tennessee Knoxville** team introduced state-of-the-art machine learning concepts, attention-based U-Net architecture, together with generative-adversary-network (GAN) based data augmentation, to the MagNet Challenge. U-Net, as shown in Fig. 14, is a neural network architecture widely used for image segmentation. The team specifically designed a U-Net architecture to adapt to the intricate and varying nature of magnetic materials and operational environments. The large U-Net model excelled for 3C92, T37, and 3C95, but didn't perform well for 79 and ML95S.

The teams from **Arizona State University**, **Xi'an Jiaotong University**, **Tsinghua University**, **National Taipei**

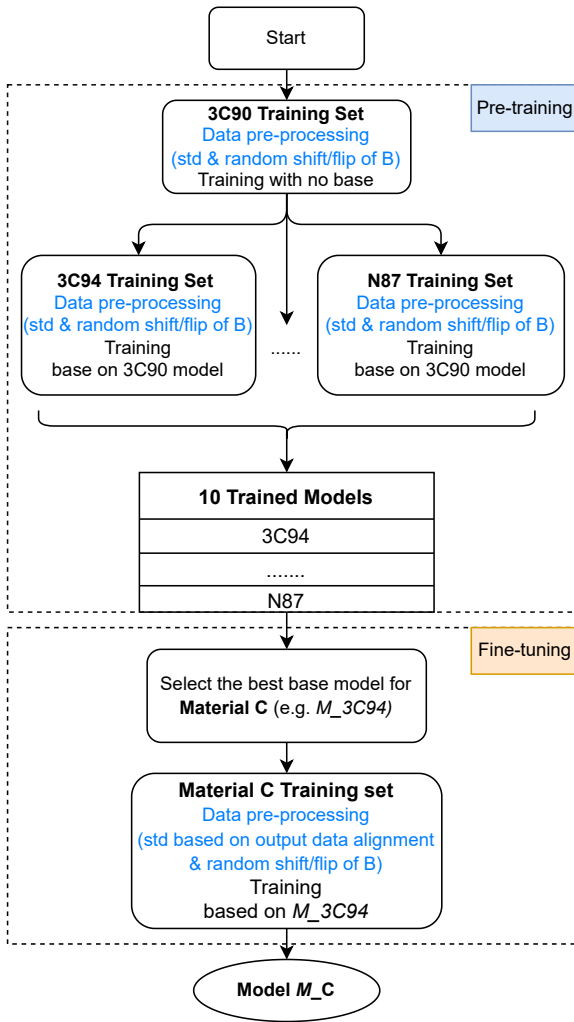

FIGURE 12. Transfer learning strategy from University of Bristol.

University of Technology, Nanyang Technological University, and Hangzhou Dianzi University also presented a variety of neural network architectures (combinations of ViT, CNN, FCNN, LSTM, and Transformer) together with systematic training and fine-tuning strategies for cross-modeling of many materials. These methods tried to leverage more advanced signal processing techniques (e.g., patch embedding, class token, quantization) to reduce the load of the neural networks and use fewer parameters. Some of these models have very good performance and the model sizes are relatively small.

The KU-Leuven team introduced a novel Conditional Generative Adversarial Network (cGANET) model [43] which explores the possibility of training an adversarial neural network to improve the trustworthiness of a traditional neural network approach, as illustrated in Fig. 15. It has the potential to ensure bounded safety for data-driven methods to predict trustworthy results.

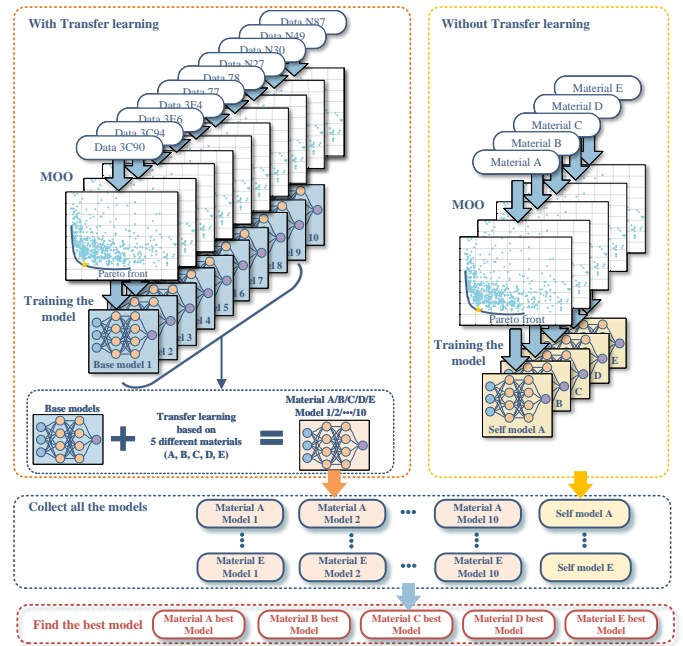

FIGURE 13. The multi-material transfer learning and multi-objective optimization method proposed by TU Delft [42].

C. White-Box Equation-based Approach

The most successful equation-based attempt in the MagNet Challenge is the ci2GSE method developed by the team from Mondragon University, a continuation of the composite improved Generalized Steinmetz Equation (ciGSE) [44]. The method is a combination of the original true Steinmetz Equation (tSE), the improved Generalized Steinmetz Equation (iGSE), the composite waveform hypothesis (CWH), and the improved improved Generalized Steinmetz Equation (i2GSE). For each temperature point, the ci2GSE uses 9 parameters to describe the core loss a three step trapezoidal excitation as:

$$P_v = \Sigma [D(e^{k'_1 + a_1 \ln |\frac{dB}{dt}|} + b_1 \ln \Delta B + e^{k'_2 + a_2 \ln |\frac{dB}{dt}|} + b_2 \ln \Delta B)] + f \times e^{k'_{rel} + a_{rel} \ln |t_{rel}| + b_{rel} \ln \Delta B}, \quad (6)$$

where k'_1 , k'_2 , k'_{rel} , a_1 , a_2 , a_{rel} , and b_1 , b_2 , b_{rel} are the Steinmetz parameters used to describe the core losses in the three sub-sections of the piece-wise linear waveforms (e.g., triangle and trapezoidal excitations). The core losses during the relaxation time are captured. In addition, six additional parameters p_{00} , p_{10} , p_{01} , p_{20} , p_{11} and p_{02} , are used to fit the sinusoidal core loss data into the three dimension f , ΔB , and P_v plane. The curve-fitting was performed for each temperature. The total number of parameters needed to describe the material characteristics at four temperature points are $(9 + 6) \times 4 = 60$. The curve-fitting algorithm was implemented in Excel and was fully automated. The average 95th percentile error of this method is about 15%, which is impressive given that the model has only 60 parameters. Limitations of the curve-fitting approach can be seen in

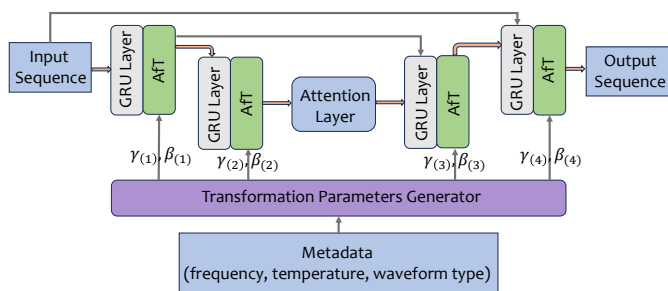

FIGURE 14. The U-Net architecture developed by University of Tennessee Knoxville, representing an out-of-the-box attempt by using state-of-the-art neural network architecture.

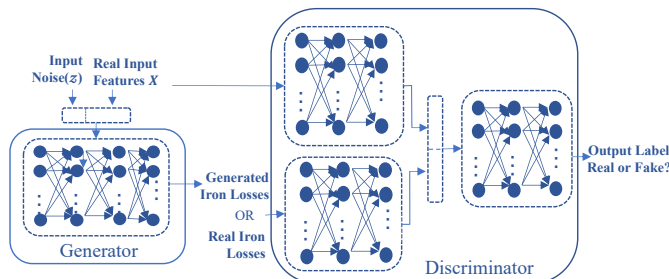

FIGURE 15. The cGANET architecture developed by KU Leuven [43].

the results for material 79 “waveform challenge”, with a noticeably high 95th percentile error of 93% due to missing relaxation data in the training dataset. This error could be decreased by pre-definition of the Steinmetz parameters if additional training data were available.

Another impressive equation-based approach was developed by the **Southeast University SEU-MC** team employing the vector magnetic circuit theory to predict core loss. The theory is developed based on lumped circuit analysis and is very similar to the Laithwaite magnetic equivalent circuit model [45]. The model on average used 60 parameters to describe each material, and reach a similar accuracy as that of the Mondragon model. However, the model tuning process is not fully automated.

III. STATISTICS OF THE MODELING RESULTS

The data and models generated by the MagNet Challenge can be used to verify a wide range of hypotheses in power magnetic modeling. An example hypothesis that we can verify (suggested by **Arizona State University** after the Challenge completed) is:

- **“For the same modeling strategy, a material with more complex material characteristics, smaller data size, or lower data quality, may naturally lead to lower modeling accuracy and higher prediction variation among different models.”**

To verify this hypothesis, we statistically evaluate the prediction results of different core loss models developed by different teams for a wide range of operating conditions. Figures 16 shows the correlation between the prediction vari-

ation and average prediction error for Materials {A, B, C, D, E}, respectively. The prediction variation is the standard deviation of the core losses predicted by the models developed by the different teams, normalized to the average predicted core loss and expressed in percent. A higher prediction variation indicates that the results predicted by different teams are very different from each other, indicating complex material characteristics. The average prediction error is the geometric mean of the prediction errors of the different models compared to the ground-truth measurement results. A higher prediction variation indicates that the material is more difficult to model, yielding higher average prediction error. In this test, material D is the most challenging to model with the highest prediction variation and the highest average prediction error. This hypothesis is consistent with the results of the MagNet Challenge.

IV. MAGNET CHALLENGE ROADMAP

The ultimate goal of the MagNet Challenge is to explore and compare a wide range of modeling strategies for power magnetic components, and to optimize and automate power magnetic design. To this end, we believe that a future MagNet model should have the following characteristics:

- **Accuracy:** to reach a high level of model accuracy (as accurate as the data accuracy and sample-to-sample variation) and repeatability for magnetics modeling in the design, development, and manufacturing process, and to precisely reflect the multi-scale and multi-physics nature of power magnetic material modeling.
- **Compactness:** to achieve efficient model training, rapid simulation, and effective optimization. This is particularly important given the lack of sufficient high-quality publicly available training data and the potentially huge design space (materials, geometries) and model operating space (excitation waveforms, temperatures, frequencies, peak flux densities, etc.) of magnetic components. A simpler model generally means a smaller number of model parameters and a more efficient usage of measurement data.
- **Generality, consistency, and versatility:** a good power magnetic component model should be applicable to a wide range of application scenarios with minimum limitations, and be consistent with other existing component models (e.g., semiconductor models and capacitor models) for high fidelity design and simulation, and be versatile so that it can be adjusted for different design purposes (e.g., trading model simplicity for accuracy).

Based on the outcomes of the MagNet Challenge, equation-based methods and data-driven methods both have their strengths and weaknesses, and they both have significant room to improve. They can also be expanded or merged to cover more sophisticated application scenarios and modeling needs. Fig. 17 shows the strategic roadmap of the MagNet Challenge in the near future, including the topics

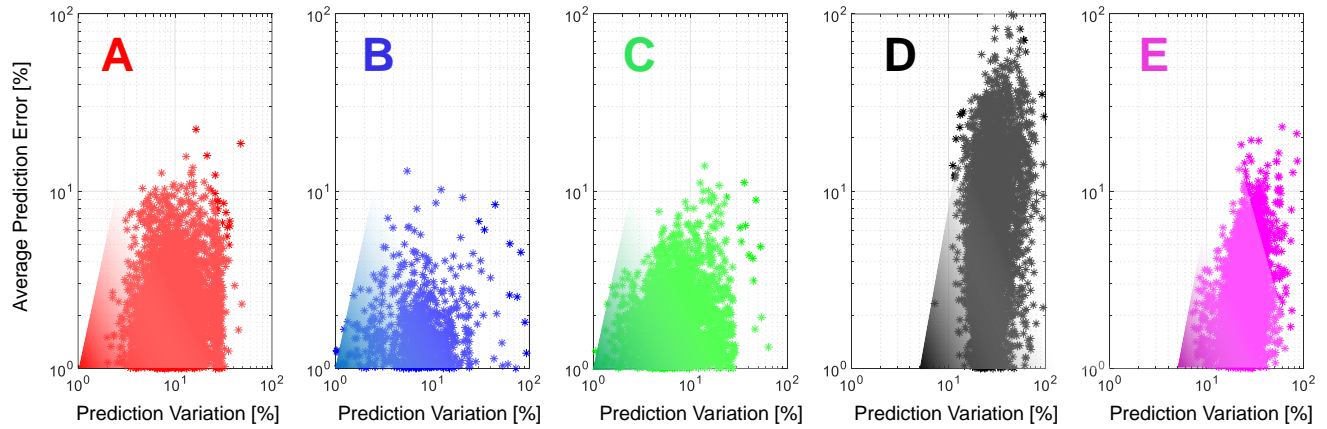

FIGURE 16. The correlation between the prediction variation and the average prediction error of the MagNet Challenge final evaluation for each data point of the 5 materials {A, B, C, D, E}, plotted in log scale (each dot represents an operating point under test). The 5 materials are {3C92, T37, 3C95, 79, ML95S}, respectively. A higher prediction variation among different modeling strategies usually lead to a higher average prediction error. Material D is verified as the most challenging material to model in the MagNet Challenge. It has the highest prediction variation (i.e., more than 10% variation among different models) and the highest average prediction error (approaching 100% in the worst case).

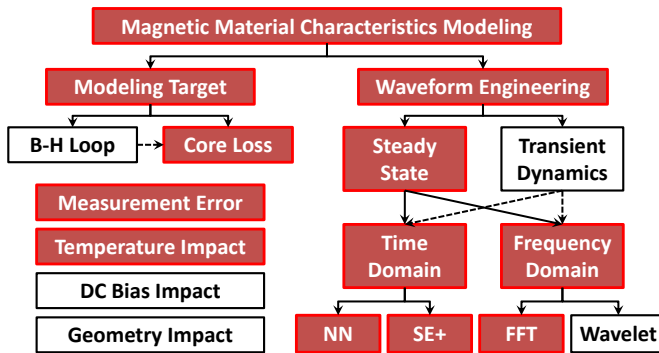

FIGURE 17. Roadmap of the MagNet challenge with addressed topics marked in red boxes, and example future topics marked in white boxes.

that have been covered in 2023. This roadmap is in line with the above-mentioned characteristics of the envisioned MagNet model, with a particular focus on the generality of the model. For example, the MagNet Challenge in 2023 prioritized model accuracy and simplicity for periodic steady state, major-loop, and zero dc bias types of excitation waveforms. The excitation frequency is limited to the tens to hundreds kilohertz range at sparse temperature points (four points only). In the future, more complicated excitation profiles (e.g., transient excitations with minor-loop and non-zero dc bias), wider operation range (e.g., frequency range up to a few megahertz), mixed-frequency operation (e.g., magnetic components in switched-mode ac-dc converters) and geometry impacts will need to be explored.

The winning models in the MagNet Challenge perform well under the designated training and testing scenarios, but do not necessarily perform well in other scenarios and may not be the most appealing modeling strategies. Better models and better interpretations are still to be found. The

potential technologies that will be explored in future Magnet Challenges may include:

- **Data Engineering:** In MagNet Challenge 2023, the data acquisition was performed by the Challenge organizer and managed and distributed in a centralized way. Data acquisition should be standardized and be rigorously cross-validated and certified across institutions and material manufacturers. For data-driven methods, the quality of a model is fundamentally limited by the quality of data. In future challenges, an open-source, transparent, community-driven data management strategy, together with strong industry support, may ensure sustainable development by the community.
- **Model Framework:** In MagNet Challenge 2023, Black-Box Data-Driven methods, White-Box Equation-based methods, and Grey-Box Hybrid methods were explored. A majority of student teams performed time domain analysis. Frequency domain methods were used less and may be worth further exploration. The machine learning frameworks are rapidly evolving and it is still early to identify the best strategy for modeling power magnetic materials. Modeling frameworks that can be naturally expanded and updated to cover many different materials under a unified framework are worth exploration. Modeling frameworks that can naturally interface with large-language models could also be interesting.
- **Data Visualization:** Power magnetic material modeling is naturally complex and has high dimensionality. Systematically compressing, filtering, and visualizing the high-dimension data for human interpretation is critical for advancing the human-data interface and enabling new data-driven applications.
- **Physical Insights and Better Materials:** Although MagNet Challenge 2023 didn't intend to close the

loop for advancing physical understanding of power magnetic materials, many teams attempted to do so (e.g., UTK, SEU-MC). With a larger data set, better data quality, more powerful data-driven models, and better human-data interface, we hope the MagNet Challenge can ultimately lead to enhanced physical understanding of power magnetic materials, and better magnetic material and component design.

V. CONCLUSION

This paper summarizes the key progress and major outcomes of the MagNet Challenge in 2023, an International Challenge on Design Methods in Power Electronics supported by the IEEE Power Electronics Society, Google, and Enphase Energy. The critical outcomes and performance ranking of the challenge entries are summarized and highlighted. It represents a pioneering collaborative research initiative in power electronics for tackling large-scale sophisticated research topics which can only be addressed by open-source community efforts.

ACKNOWLEDGMENT

The authors acknowledge the following personnel for their support of the MagNet Challenge in 2023: John G. Kasakian, Brad Lehman, Alan Mantooh, Frede Blaabjerg, Patrick Wheeler, Gerard Hurley, Mario Pacas, Dehong Xu, Maeve Duffy, Matt Wilkowski, Liucheng Chang, Philip Krein, Khurram Afridi, Shuai Jiang, David Schumacher, Kaladhar Radhakrishnan, Niraj Jha, Yuxin Chen, Mike Kelly, Brianna Fornaro, George Slama, Edward Herbert, Jens Schweickhardt, Ziwei Ouyang, Alex Hanson, Kevin Hermanns, Shirley Pei, Subham Sahoo, Miroslav Vasic, Brenda Mikeo, Yidong Tian, Cheng Zhang and many others.

This work was jointly supported by the DOE ARPA-E DIFFERENTIATE program, the National Science Foundation, Google, Enphase, Intel, IEEE Power Electronics Society, and the Schmidt DataX Fund at Princeton University made possible through a major gift from the Schmidt Futures Foundation.

APPENDIX: MagNet Challenge 2023 Participating Teams

The 39 undergraduate and graduate teams that registered for the MagNet Challenge in 2023 were:

- 1) Aalborg University, Denmark
- 2) Arizona State University, USA
- 3) Cornell University Team 1, USA
- 4) Cornell University Team 2, USA
- 5) Federal University of Santa Catarina, Brazil
- 6) Fuzhou University, China
- 7) Hangzhou Dianzi University, China
- 8) Indian Institute of Science, India
- 9) Jinan University, China
- 10) Katholieke Universiteit Leuven, Belgium
- 11) Mondragon University, Spain
- 12) Nanjing University of Posts and Telecom., China

- 13) Nanyang Technological University, Singapore
- 14) Nation Taipei University of Technology, Taiwan
- 15) Northeastern University, USA
- 16) Paderborn University, Germany
- 17) Politecnico di Torino, Italy
- 18) Purdue University, USA
- 19) Seoul National University, Korea
- 20) Silicon Austria Labs, Austria
- 21) Southeast University SEU-WX, China
- 22) Southeast University SEU-MC, China
- 23) Tribhuvan University, Pulchowk Campus, Nepal
- 24) Tsinghua University, China
- 25) Delft University of Technology, the Netherlands
- 26) University of Bristol, UK
- 27) University of Colorado Boulder, USA
- 28) University of Kassel, Germany
- 29) University of Manchester, UK
- 30) University of Nottingham, UK
- 31) University of Sydney, Australia
- 32) University of Tennessee, USA
- 33) University of Twente Team 1, the Netherlands
- 34) University of Twente Team 2, the Netherlands
- 35) University of Wisconsin-Madison, USA
- 36) Universidad Politécnica de Madrid, Spain
- 37) Xi'an Jiaotong University, China
- 38) Zhejiang University, China
- 39) Zhejiang University-UIUC, China

The 23 teams that qualified for the round #2 competition and submitted the final results were:

- 1) Arizona State University (ASU), USA
- 2) Fuzhou University (**Fuzhou**), China
- 3) Hangzhou Dianzi University (**HDU**), China
- 4) Indian Institute of Science (**IISc**), India
- 5) Katholieke Univ. Leuven (**KU Leuven**), Belgium
- 6) Mondragon University (**Mondragon**), Spain
- 7) Nanjing Univ. of Posts and Telecom. (**NJUPT**), China
- 8) Nanyang Technological University (**NTU**), Singapore
- 9) National Taipei Univ. of Technology (**NTUT**), Taiwan
- 10) Paderborn University (**Paderborn**), Germany
- 11) Politecnico di Torino (**PoliTO**), Italy
- 12) Silicon Austria Labs (**SAL**), Austria
- 13) Southeast University (**SEU-WX**), China
- 14) Southeast University (**SEU-MC**), China
- 15) Tribhuvan University (**Tribhuvan**), Nepal
- 16) Tsinghua University (**Tsinghua**), China
- 17) Delft Univ. of Technology (**TU-Delft**), the Netherlands
- 18) University of Bristol (**Bristol**), UK
- 19) University of Colorado Boulder (**CU-Boulder**), USA
- 20) University of Sydney (**Sydney**), Australia
- 21) University of Tennessee Knoxville (**UTK**), USA
- 22) Xi'an Jiaotong University (**XJTU**), China
- 23) Zhejiang University-UIUC (**ZJUI**), China

The 7 final winners of the MagNet Challenge are:

- Model Performance 1st Place: Paderborn University
- Model Performance 2nd Place: Fuzhou University
- Model Performance 3rd Place: University of Bristol
- Excellent Innovation 1st Place: University of Sydney
- Excellent Innovation 2nd Place: Delft Univ. of Tech.
- Excellent Innovation 3rd Place: Mondragon University
- Software Engineering Award: University of Sydney

The 9 honorable mention teams are:

- Arizona State University
- Indian Institute of Science
- Xi'an Jiaotong University
- Zhejiang University-UIUC
- University of Tennessee
- Politecnico di Torino
- Southeast University SEU-WX
- Southeast University SEU-MC
- Tsinghua University

REFERENCES

- [1] C. R. Sullivan, B. A. Reese, A. L. F. Stein, and P. A. Kyaw, "On size and magnetics: Why small efficient power inductors are rare," in *2016 International Symposium on 3D Power Electronics Integration and Manufacturing (3D-PEIM)*, 2016, pp. 1–23.
- [2] D. J. Perreault, J. Hu, J. M. Rivas, Y. Han, O. Leitermann, R. C. Pilawa-Podgurski, A. Sagneri, and C. R. Sullivan, "Opportunities and challenges in very high frequency power conversion," in *2009 Twenty-Fourth Annual IEEE Applied Power Electronics Conference and Exposition*, 2009, pp. 1–14.
- [3] M. Chen and C. R. Sullivan, "Unified models for coupled inductors applied to multiphase pwm converters," *IEEE Transactions on Power Electronics*, vol. 36, no. 12, pp. 14 155–14 174, 2021.
- [4] S. Wang, H. Li, D. Serrano, T. Guillod, J. Li, C. Sullivan, and M. Chen, "A simplified dc-bias injection method for characterizing power magnetics using a voltage mirror transformer," *IEEE Transactions on Power Electronics*, vol. 39, no. 6, pp. 6608–6612, 2024.
- [5] G. Skutt and F. Lee, "Characterization of dimensional effects in ferrite-core magnetic devices," in *PESC Record. 27th Annual IEEE Power Electronics Specialists Conference*, vol. 2, 1996, pp. 1435–1440 vol.2.
- [6] P. Papamanolis, T. Guillod, F. Krismer, and J. W. Kolar, "Transient calorimetric measurement of ferrite core losses up to 50 mhz," *IEEE Transactions on Power Electronics*, vol. 36, no. 3, pp. 2548–2563, 2021.
- [7] M. Chen, M. Araghchini, K. K. Afridi, J. H. Lang, C. R. Sullivan, and D. J. Perreault, "A systematic approach to modeling impedances and current distribution in planar magnetics," *IEEE Transactions on Power Electronics*, vol. 31, no. 1, pp. 560–580, 2016.
- [8] T. Shimizu and S. Iyasu, "A practical iron loss calculation for ac filter inductors used in pwm inverters," *IEEE Transactions on Industrial Electronics*, vol. 56, no. 7, pp. 2600–2609, 2009.
- [9] H. Matsumori, T. Shimizu, K. Takano, and H. Ishii, "Evaluation of iron loss of ac filter inductor used in three-phase pwm inverters based on an iron loss analyzer," *IEEE Transactions on Power Electronics*, vol. 31, no. 4, pp. 3080–3095, 2016.
- [10] H. Matsumori, T. Shimizu, X. Wang, and F. Blaabjerg, "A practical core loss model for filter inductors of power electronic converters," *IEEE Journal of Emerging and Selected Topics in Power Electronics*, vol. 6, no. 1, pp. 29–39, 2018.
- [11] D. Serrano, H. Li, S. Wang, T. Guillod, M. Luo, V. Bansal, N. K. Jha, Y. Chen, C. R. Sullivan, and M. Chen, "Why magnet: Quantifying the complexity of modeling power magnetic material characteristics," *IEEE Transactions on Power Electronics*, vol. 38, no. 11, pp. 14 292–14 316, 2023.
- [12] H. H. Cui, S. Dulal, S. B. Sohid, G. Gu, and L. M. Tolbert, "Unveiling the microworld inside magnetic materials via circuit models," *IEEE Power Electronics Magazine*, vol. 10, no. 3, pp. 14–22, 2023.
- [13] J. M. Silveyra, E. Ferrara, D. L. Huber, and T. C. Monson, "Soft magnetic materials for a sustainable and electrified world," *Science*, vol. 362, no. 6413, p. eaao0195, 2018. [Online]. Available: <https://www.science.org/doi/abs/10.1126/science.aao0195>
- [14] H. Tanaka, K. Nakamura, and O. Ichinokura, "Calculation of iron loss in soft ferromagnetic materials using magnetic circuit model taking magnetic hysteresis into consideration," *Journal of the Magnetics Society of Japan*, vol. 39, no. 2, pp. 65–70, 2015. [Online]. Available: <https://cir.nii.ac.jp/crid/1390001205288243840>
- [15] C. P. Steinmetz, "On the law of hysteresis," *Proceedings of the IEEE*, vol. 72, no. 2, pp. 197–221, 1984.
- [16] J. Reinert, A. Brockmeyer, and R. De Doncker, "Calculation of losses in ferro- and ferrimagnetic materials based on the modified steinmetz equation," *IEEE Transactions on Industry Applications*, vol. 37, no. 4, pp. 1055–1061, 2001.
- [17] A. Van den Bossche, V. Valchev, and G. Georgiev, "Measurement and loss model of ferrites with non-sinusoidal waveforms," in *2004 IEEE 35th Annual Power Electronics Specialists Conference (IEEE Cat. No.04CH37551)*, vol. 6, 2004, pp. 4814–4818 Vol.6.
- [18] S. Barg, K. Ammous, H. Mejbri, and A. Ammous, "An improved empirical formulation for magnetic core losses estimation under nonsinusoidal induction," *IEEE Transactions on Power Electronics*, vol. 32, no. 3, pp. 2146–2154, 2017.
- [19] E. Stenglein and T. Dürbaum, "Core loss model for arbitrary excitations with dc bias covering a wide frequency range," *IEEE Transactions on Magnetics*, vol. 57, no. 6, pp. 1–10, 2021.
- [20] C. R. Sullivan, J. H. Harris, and E. Herbert, "Core loss predictions for general pwm waveforms from a simplified set of measured data," in *2010 Twenty-Fifth Annual IEEE Applied Power Electronics Conference and Exposition (APEC)*, 2010, pp. 1048–1055.
- [21] T. Guillod, J. S. Lee, H. Li, S. Wang, M. Chen, and C. R. Sullivan, "Calculation of ferrite core losses with arbitrary waveforms using the composite waveform hypothesis," in *2023 IEEE Applied Power Electronics Conference and Exposition (APEC)*, 2023, pp. 1586–1593.
- [22] K. Venkatachalam, C. Sullivan, T. Abdallah, and H. Tacca, "Accurate prediction of ferrite core loss with nonsinusoidal waveforms using only steinmetz parameters," in *2002 IEEE Workshop on Computers in Power Electronics, 2002. Proceedings.*, 2002, pp. 36–41.
- [23] J. Muhlethaler, J. Biela, J. W. Kolar, and A. Ecklebe, "Improved core-loss calculation for magnetic components employed in power electronic systems," *IEEE Transactions on Power Electronics*, vol. 27, no. 2, pp. 964–973, 2012.
- [24] S. Hui and J. Zhu, "Magnetic hysteresis modeling and simulation using the preisach theory and tlm technique," in *Proceedings of 1994 Power Electronics Specialist Conference - PESC'94*, vol. 2, 1994, pp. 837–842 vol.2.
- [25] F. Sixdenier, R. Scorretti, R. Marion, and L. Morel, "Quasistatic hysteresis modeling with feed-forward neural networks: Influence of the last but one extreme values," *Journal of Magnetism and Magnetic Materials*, vol. 320, no. 20, pp. e992–e996, 2008.
- [26] C. Grech, M. Buzio, M. Pentella, and N. Sammut, "Dynamic ferromagnetic hysteresis modelling using a Preisach-recurrent neural network model," *Materials*, vol. 13, no. 11, p. 2561, 2020.
- [27] S. Quondam Antonio, F. Riganti Fulginei, A. Laudani, A. Faba, and E. Cardelli, "An effective neural network approach to reproduce magnetic hysteresis in electrical steel under arbitrary excitation waveforms," *Journal of Magnetism and Magnetic Materials*, vol. 528, p. 167735, 2021.
- [28] F. Preisach, "Über die magnetische nachwirkung," *Zeitschrift für Physik*, vol. 94, no. 5, pp. 277–302, May 1935. [Online]. Available: <https://doi.org/10.1007/BF01349418>
- [29] D. Jiles and D. Atherton, "Theory of ferromagnetic hysteresis," *Journal of Magnetism and Magnetic Materials*, vol. 61, pp. 48–60, 1986.
- [30] H. Li, D. Serrano, T. Guillod, S. Wang, E. Dogariu, A. Nadler, M. Luo, V. Bansal, N. K. Jha, Y. Chen, C. R. Sullivan, and M. Chen, "How magnet: Machine learning framework for modeling power magnetic material characteristics," *IEEE Transactions on Power Electronics*, vol. 38, no. 12, pp. 15 829–15 853, 2023.
- [31] H. Li, D. Serrano, S. Wang, and M. Chen, "Magnet-ai: Neural network as datasheet for magnetics modeling and material recommendation,"

- IEEE Transactions on Power Electronics*, vol. 38, no. 12, pp. 15 854–15 869, 2023.
- [32] C. P. Steinmetz, “On the law of hysteresis,” *Transactions of the American Institute of Electrical Engineers*, vol. IX, no. 1, pp. 1–64, 1892.
- [33] —, “On the law of hysteresis (part ii.) and other phenomena of the magnetic circuit,” *Transactions of the American Institute of Electrical Engineers*, vol. IX, no. 1, pp. 619–758, 1892.
- [34] O. Russakovsky, J. Deng, H. Su, J. Krause, S. Satheesh, S. Ma, Z. Huang, A. Karpathy, A. Khosla, M. Bernstein, A. C. Berg, and L. Fei-Fei, “Imagenet large scale visual recognition challenge,” *International Journal of Computer Vision*, vol. 115, no. 3, pp. 211–252, Dec 2015. [Online]. Available: <https://doi.org/10.1007/s11263-015-0816-y>
- [35] J. Li, E. Deleu, W. Lee, H. Li, M. Chen, and S. Wang, “Investigating the mutual impact of waveform, temperature, and dc-bias on magnetic core loss using neural network models,” in *2024 IEEE Applied Power Electronics Conference and Exposition (APEC)*, 2024, pp. 391–395.
- [36] W. Kirchgässner, N. Förster, T. Piepenbrock, O. Schweins, and O. Wallscheid, “Hardcore: H-field and power loss estimation for arbitrary waveforms with residual, dilated convolutional neural networks in ferrite cores,” 2024. [Online]. Available: <https://doi.org/10.48550/arXiv.2401.11488>
- [37] S. Barg, K. Ammous, H. Mejbri, and A. Ammous, “An improved empirical formulation for magnetic core losses estimation under nonsinusoidal induction,” *IEEE Transactions on Power Electronics*, vol. 32, no. 3, pp. 2146–2154, 2017.
- [38] B. Sauter, S. Reese, S. Sinha, J. Haddon, T. Byrd, and D. Maksimovic, “Integrating equation-based methods with random forest regression for improved accuracy of magnetic core loss modeling,” in *2024 IEEE Applied Power Electronics Conference and Exposition (APEC)*, 2024, pp. 410–415.
- [39] D. B. Sapkota, P. Neupane, M. Joshi, and S. Khan, “Deep learning model for enhanced power loss prediction in the frequency domain for magnetic materials,” *IET Power Electronics*. [Online]. Available: <https://ietresearch.onlinelibrary.wiley.com/doi/abs/10.1049/pel2.12704>
- [40] E. Deleu, H. Li, J. Li, W. Lee, T. Guillod, C. R. Sullivan, S. Wang, and M. Chen, “Multi-material power magnetics modeling with a modular and scalable machine learning framework,” in *2024 IEEE Applied Power Electronics Conference and Exposition (APEC)*, 2024, pp. 370–377.
- [41] E. Dogariu, H. Li, D. Serrano López, S. Wang, M. Luo, and M. Chen, “Transfer learning methods for magnetic core loss modeling,” in *2021 IEEE 22nd Workshop on Control and Modelling of Power Electronics (COMPEL)*, 2021, pp. 1–6.
- [42] Z. Li, L. Wang, R. Liu, R. Mirzadarani, T. Luo, D. Lyu, M. G. Niasar, and Z. Qin, “A data-driven model for power loss estimation of magnetic materials based on multi-objective optimization and transfer learning,” *IEEE Open Journal of Power Electronics*, vol. 5, pp. 605–617, 2024.
- [43] X. Shen, Y. Zuo, and W. Martinez, “Conditional generative adversarial network aided iron loss prediction for high-frequency magnetic components,” *IEEE Transactions on Power Electronics*, pp. 1–14, 2024.
- [44] A. Arruti, J. Anzola, F. J. Pérez-Cebolla, I. Aizpuru, and M. Mazuela, “The composite improved generalized steinmetz equation (cigse): An accurate model combining the composite waveform hypothesis with classical approaches,” *IEEE Transactions on Power Electronics*, vol. 39, no. 1, pp. 1162–1173, 2024.
- [45] E. Lwithwaite, “Magnetic equivalent circuits for electrical machines,” *Proceedings of the Institution of Electrical Engineers*, vol. 114, pp. 1805–1809(4), November 1967. [Online]. Available: <https://digital-library.theiet.org/content/journals/10.1049/piee.1967.0344>