

# A Tutorial on IEEE 802.11ax High Efficiency WLANs

Evgeny Khorov<sup>id</sup>, Anton Kiryanov, Andrey Lyakhov, and Giuseppe Bianchi

**Abstract**—While celebrating the 21st year since the very first IEEE 802.11 “legacy” 2 Mbit/s wireless local area network standard, the latest Wi-Fi newborn is today reaching the finish line, topping the remarkable speed of 10 Gbit/s. IEEE 802.11ax was launched in May 2014 with the goal of enhancing throughput-per-area in high-density scenarios. The first 802.11ax draft versions, namely, D1.0 and D2.0, were released at the end of 2016 and 2017. Focusing on a more mature version D3.0, in this tutorial paper, we help the reader to smoothly enter into the several major 802.11ax breakthroughs, including a brand new orthogonal frequency-division multiple access-based random access approach as well as novel spatial frequency reuse techniques. In addition, this tutorial will highlight selected significant improvements (including physical layer enhancements, multi-user multiple input multiple output extensions, power saving advances, and so on) which make this standard a very significant step forward with respect to its predecessor 802.11ac.

**Index Terms**—Wireless LAN, quality of service, OFDM, IEEE 802.11ax, high efficiency WLANs, Wi-Fi, dense deployment, OFDMA, UL MU-MIMO.

## I. INTRODUCTION

WHEN, in September 1990, the very first meeting of the 802.11 project was held, hardly anyone could imagine the extent to which that early initiative, devised to - verbatim quoting the original 802.11 Project Authorization Request — “develop a Medium Access Control (MAC) and Physical Layer (PHY) specification for wireless connectivity for fixed, portable and moving stations within a local area”, would have changed our connectivity habits.

Indeed, in these last 28 years, Wi-Fi — specified by the family of the IEEE 802.11 standards — has widely spread across virtually any user’s device, as well as any inhabited deployment — homes, offices, cafes, parks, airports, etc. Moreover, it has been extended with several technical facilities which have permitted its evolution from “just” a low-rate

Manuscript received August 17, 2017; revised March 20, 2018 and July 5, 2018; accepted August 23, 2018. Date of publication September 20, 2018; date of current version February 22, 2019. The work of E. Khorov, A. Kiryanov, and A. Lyakhov was supported by the Russian Science Foundation under Agreement 16-19-10687. (Corresponding author: Evgeny Khorov.)

E. Khorov and A. Lyakhov are with the Institute for Information Transmission Problems, Russian Academy of Sciences, Moscow 127051, Russia (e-mail: khorov@iitp.ru; lyakhov@iitp.ru).

A. Kiryanov is with the Institute for Information Transmission Problems, Russian Academy of Sciences, Moscow 127051, Russia, and also with the National Research Institute Higher School of Economics, Moscow 101000, Russia (e-mail: kiryanov@iitp.ru).

G. Bianchi is with the University di Roma Tor Vergata, 00173 Rome, Italy (e-mail: giuseppe.bianchi@uniroma2.it).

Digital Object Identifier 10.1109/COMST.2018.2871099

cable replacement to a full fledged comprehensive network infrastructure and a wireless access alternative to cellular connectivity [1].

Nevertheless, the impressive deployment success of the Wi-Fi technology is also threatening its future growth. Users are more and more demanding; networks’ and clients’ density is ever increasing, and soon the current state-of-the-art of the Wi-Fi technology might fail short in efficiently serving the foreseen customers’ base.

The evolution of the standards shows a significant increase in nominal data rates: from the “legacy” 2 Mbit/s IEEE 802.11-1997, to the 11 Mbit/s of 802.11b, the 54 Mbit/s of 802.11a/g, the 600 Mbit/s of 802.11n, and the above Gbit/s rates of the latest 802.11ac. These Wi-Fi rates have been accomplished by means of faster modulation and coding schemes, wider channels, and the adoption of Multiple Input Multiple Output (MIMO) technologies [2]. Unfortunately, the analysis of the latest 802.11ac networks shows that the further increase of Wi-Fi throughput in a legacy spectrum needs new channel access approaches rather than just widening the band or increasing the number of spatial streams (see [3], [4] and other documents of the former IEEE 802.11 High Efficiency Wireless LAN Study Group (HEW WLAN SG)). Moreover, albeit being a key asset, a high nominal data rate is not fully representative for the performance of a Wi-Fi deployment. The network operation is in fact further affected by interference patterns and frequency-selective attenuation, as well as medium access inefficiencies and network configuration scenarios. And sheer capacity might not even be the main requirement for several applications and services.

### A. The 802.11ax Challenge: Dense Networks

The most notable 802.11ax’s design driver is the recognition that, today, WLAN devices are deployed in very diverse environments, characterized by the presence of a massive number of terminals concentrated in localized geographic areas. Corporate offices, mass events, outdoor hotspots, shopping malls, airports, exhibition halls, dense residential apartments, stadiums, and so on, are all examples of *dense environments* [5], whose coverage requires a multiplicity of Access Points (APs) — in principle even up to hundreds [6] — which may therefore require to be operated on (partially) overlapping channels. In such environments, the aggregate throughput is not anymore the main performance metric of interest; rather, the target should be an increase of the *throughput density*, i.e., the *throughput-per-area* which is defined as the ratio of the total network throughput to the network area [7], [8].

TABLE I  
LIST OF ACRONYMS

AC	Access Category
ACK	Acknowledgment
A-MPDU	Aggregated MAC Protocol Data Unit
A-MSDU	Aggregated MAC Service Data Unit
AP	Access Point
BA	Block ACK
BAR	Block ACK Request
BSR	Buffer Status Report
BSS	Basic Service Set
CSMA/CA	Carrier Sense Multiple Access with Collision Avoidance
CTS	Clear To Send
DCM	Dual Carrier Modulation
DIFS	Distributed coordination function InterFrame Space
DL	Downlink
DSC	Dynamic Sensitivity Control
EDCA	Enhanced Distributed Channel Access
EOSP	End of Service Period
GI	Guard Interval
HCCA	Hybrid Controlled Channel Access
HE	High Efficiency
HE-LTF	HE Long Training Field
HE-STF	HE Short Training Field
LAN	Local Area Network
L-SIG	Legacy Signal Field
MAC	Medium Access Control
MCCA	Mesh coordination function Controlled Channel Access
MCS	Modulation and Coding Scheme
MIMO	Multiple Input Multiple Output
MRG	Margin
MU	Multuser
MU-CTS	MU Clear To Send
MU-RTS	MU Request To Send
NAV	Network Allocation Vector
NSTS	Number of spatial streams
OBO	OFDMA Back-off
OBSS	Overlapping BSS
OFDM	Orthogonal Frequency-Division Multiplexing
OFDMA	Orthogonal Frequency-Division Multiple Access
OPS	Opportunistic Power Save
PAR	Project Authorization Request
PCF	Point Coordinated Function
PER	Packet Error Ratio
PHY	Physical Layer
PIFS	PCF InterFrame Space
PPDU	PHY Protocol Data Unit
PS	Power-saving
QoE	Quality of Experience
QoS	Quality of Service
QTP	Quiet Time Period
RIFS	Reduced InterFrame Space
RSSI	received signal strength indicator
RTS	Request To Send
RU	Resource Unit
SFD	Specification Framework Document
SIFS	Short InterFrame Space
SIG	Special Interest Group
SINR	Signal-to-Interference-plus-Noise Ratio
SRP	Spatial Reuse Parameter
STA	Station
SU	Single User
TDMA	Time Division Multiple Access
TGax	Task Group AX
TIM	Traffic Indication Map
TSPEC	Traffic Specification
TTI	Transmission Time Interval
TWT	Target Wakeup Time
TXOP	Transmission Opportunity
TX	Transmission
UL	Uplink
VAP	Virtual AP
WLAN	Wireless LAN

Obviously, in such environments, the primary source of performance degradation is the massive interference. While previous efforts aimed at avoiding hidden stations (STAs)

by forbidding transmissions that may potentially collide, 11ax focuses at improving spatial reuse by avoiding exposed STAs [9].

Apart from that, in real scenarios, networking devices rarely operate in the saturated mode, i.e., the portion of data available for transmission may be rather small. Irrespectively of the size held by an aggregated packet (within the standardized limits), there is a fixed toll to pay, in terms of time to access the channel, to separate frames and to send an acknowledgment. Thus, for small data payloads the overhead expressed in percentage of channel time may be huge, significantly degrading the application-layer throughput ultimately experienced by the end users [4].

Another challenge comes from the diminishing asymmetry in traffic patterns. The widespread deployment of social networks characterized by a significant amount of user-generated multimedia content, as well as applications which continuously interact with centralized cloud storage systems, pose a significant burden not only on the downlink (DL) transmission, as it was the case for traditional server-based information retrieval applications, but also on the uplink (UL). For DL the problem was partially solved in 802.11ac with DL Multi-user (MU) MIMO. For uplink, such a technique requires tight synchronization going well beyond what has been so far standardized in previous 802.11 amendments.

For these reasons, as well as for other more technical reasons discussed later on, such as an improved power consumption for battery-operated devices and support for better Quality of user Experience (QoE), in May 2013 the IEEE LAN/MAN Standards Committee launched a HEW Study Group, which was later converted into Task Group AX (TGax) [8]. This Task Group has attracted considerable interest by 802.11 stakeholders, as for instance witnessed by the relevant attendance statistics: during the Atlanta meeting in January 2016, as much as *half* of the IEEE 802.11 attendance credits were accumulated by this Task Group [10], with the remaining half of the crowd distributed among many additional ongoing IEEE 802.11 activities [11]. Even though the new 802.11ax amendment is planned for finalization by 2019, in the last three years a significant amount of work has been already carried out. The specification framework document (SFD) started in 2014 [12] and was finalized in May 2016. The first proposal for the draft 1.0 802.11ax amendment was released on December 1, 2016, while the second one appeared a year later.

## B. Contribution and Organization

It is worth to remark that a final consensus on the 802.11ax specification has not been reached yet. Indeed, the initial 802.11ax 1.0 draft standard was balloted in January 2017 and received just 58% of positive votes opposed to the 75% required threshold, and as many as 7334 comments officially filed. The second draft standard obtained only 63% affirmative votes. Only the third version passed the ballot with over 85% of positive votes and 2154 comments.

Still, even if the development process has clearly not yet finished and many open issues need to be addressed before finalization, some firm landmarks have now been set.

Therefore, we believe this may be the right time to report about the current status of the 802.11ax proposal and discuss the major solutions and approaches therein under consideration, in a format accessible to the wireless networking community at large.

In this tutorial paper, also leveraging our direct participation to the 802.11ax activities, our goal is threefold:

- providing a snapshot of the major solution and approaches included so far in the standardization work;
- complementing such an information with selected quantitative results which suggest the extent to which the emerging standard is able to maintain its promises of throughput quadruplication stated in the 802.11ax Project Authorization Request (PAR) document [7], and
- identifying the issues or caveats which may require further support from the research community, e.g., in terms of further ideas and/or simulation results.

This work is not the first tutorial on 802.11ax. We acknowledge that a few earlier overviews have been already written at the beginning of the development process, including [13]–[15] as well as our previous 2015 report [16]. However, such earlier tutorial papers were based on very initial ideas being discussed at that times in the 802.11ax task group, and as such are not anymore fully representative of the evolution of the 802.11ax standard. In fact, part of the initially proposed features and technical approaches have been further detailed, improved, or even superseded by the hectic standardization work carried out in the last period. In a few cases some proposals have been rejected and left to future standards. Most notably, the support for full-duplex operation, albeit popular and considered very interesting by the community, was ultimately considered out of the scope of the 802.11ax technology.<sup>1</sup>

This tutorial will introduce the reader to the technical details of the proposed Orthogonal Frequency-Division Multiple Access (OFDMA) approach (including OFDMA random access). It will clearly describe the already adopted frame structure, and will give a comprehensive overview of the new features which enable overlapping Basic Service Set (BSS) management and spatial reuse — BSS coloring, usage of Quiet Time Periods and two Network Allocation Vectors, adjustment of the sensitivity threshold and the transmit power, and others. Moreover, we will give an insight into the novel power management techniques which have already become a part of the 802.11ax draft standard.

We will also try to make this tutorial more insightful by including numerical results obtained by the researchers from both industrial companies and the academic community. Besides, we will highlight a number of open issues, some of which have to be solved in the framework of the development of the 802.11ax amendment and some of which will be converted into proprietary algorithms designed by each vendor individually.

The rest of this paper is organized as follows. In Section II, after a brief review of the state-of-the-art before 802.11ax, we

briefly introduce the main characterizing features of the new technology. In the subsequent sections, we enter into greater detail on the specific enhancements suggested for the PHY layer (Section III), the major breakthroughs in the channel access operation brought about by the adoption of OFDMA and of the MU-MIMO uplink operation and the corresponding channel access modifications (Section IV), the improvements that enable spatial reuse (Section V) and the new power management solutions proposed (Section VI).

## II. 802.11AX AT A GLANCE

Before summarizing in the next Section II-B the distinguishing features currently being proposed by the IEEE 802.11ax Task Group, we start with a brief overview of the evolution of the 802.11 standards (Section II-A). So the reader will be able to better appreciate the next steps taken in the ongoing standardization activity.

### A. Before 802.11ax: State of the Art

In the last 20 years, a number of amendments, and specifically 802.11a/b/g/n/ac (we restrict to the ones focusing on the “traditional” ISM 2.4 and 5 GHz bands), have been proposed to improve the nominal data rate.

The older ones, namely 802.11a/b/g, “simply” introduce new modulation and coding schemes so as to bring the data rate from the original 2 Mbit/s of the “legacy” 802.11-1997 up to 54 Mbit/s in both the 2.4 GHz (802.11g) and the 5 GHz (802.11a) ISM unlicensed bands.

The 802.11n proposal represents a significant step forward with respect to the above early Wi-Fi standards. Data rates significantly increased (up to a theoretical maximum of 600 Mbit/s) via a combination of techniques. These include i) the ability to exploit channels with a width of 40 MHz, which is twice larger than those used in previous 802.11 PHYs; ii) the usage of higher 5/6 coding rates opposed to the previous 3/4 coding rates, and — arguably the most notable 802.11n breakthrough — iii) the transition towards MIMO technology, i.e., the usage of multiple antennas to transmit up to 4 spatial streams simultaneously between a pair of devices, hence significantly increasing data rates.

In addition to the raw data rate increase, 802.11n provides several crucial improvements also at the MAC layer. Its goal is to reduce overhead in terms of interframe spaces, preambles, and control frames, which otherwise would not permit to properly take advantage of the performance gains provided by the newly designed PHY. Indeed, 802.11n introduces a new Reduced InterFrame Space (RIFS) of 2  $\mu$ s which can be used instead of the 10 or 16  $\mu$ s Short InterFrame Space (SIFS) to separate transmissions of the same STA, if no response is expected between these transmissions. Moreover, 802.11n introduces two aggregation methods, namely the A-MSDU (Aggregated MAC Service Data Unit) and the A-MPDU (Aggregated MAC Protocol Data Unit). The first one appends several aggregated packets with a single MAC header and check sum. The second one assigns a MAC header and frame check sum to each aggregated packet. This aggregation permits the improvement of transmission reliability by allowing

<sup>1</sup>It is worth to remark that, while we are writing this paper, IEEE 802.11 is launching a Full Duplex Topic Interest Group, which means that the standardization process will not likely start before another year or two.



the decoding of at least some packets in case of short noise bursts, at the expense of slightly increased overhead.

Since contention-based channel access inevitably leads to collisions, from the very beginning IEEE 802.11 tried to add various contention-free channel access mechanisms to the standard. Both the “historical” Point coordinated function (PCF, obsolete now) and the subsequent Hybrid Controlled Channel Access (HCCA) allow an AP to access the channel without contention. Channel access coordination is accomplished by introducing an Interframe Space called PIFS (PCF InterFrame Space) which, being shorter than the DIFS (Distributed coordination function InterFrame Space) used by the remaining STAs, permits the AP to acquire the channel access without any contention, so as to transmit data or poll the STAs and grant them channel access. In practice, contention-free access techniques have seen a very marginal deployment, especially because of their inefficiency in scenarios when several APs work in the same area. Indeed, if several APs use PIFS, their transmissions will start simultaneously and collide. This problem is partially addressed in the HCCA TXOP Negotiation mechanism introduced in 802.11aa. The mechanism allows various APs to use different time intervals for transmission. Unfortunately, HCCA TXOP Negotiation can only avoid collisions between APs which can communicate with each other. Moreover, it does not reduce the collision probabilities between an AP and the alien STAs, which still can use random access.

The IEEE 802.11 Working Group has historically put a significant effort to improve the Quality of Service (QoS) in Wi-Fi networks. Specifically, the 802.11e amendment introduces Enhanced Distributed Channel Access (EDCA) and HCCA which distinguish voice, video, best effort and background traffic and serve them differently. While EDCA just assigns different priorities to these types of traffic, the sophisticated HCCA allows an AP to schedule transmissions taking into account specific QoS requirements, like the delay bound, the packet loss ratio, or the required bandwidth. However, determining exact requirements is a non trivial task, and arguably another key reason behind the scarce deployment of the contention-free HCCA.

For many devices which use Wi-Fi (e.g., laptops and smartphones) power consumption is an important issue. In 802.11 networks, power management is based on alternating between two states: awake and doze. In the awake state, a STA can transmit and receive frames, while in the doze state, its radio is switched off. An active STA is always awake, while a power-saving (PS) STA alternates between these states. The AP buffers data destined for PS STAs until the STA wakes up and retrieves it. Many amendments introduce new power-saving features, but most of them are related to switching off the radio for a rather long time, i.e., for hundreds of milliseconds or even for seconds. Some of them require a PS STA to contend for the channel if it wants to retrieve data from the AP. Such methods are inefficient in dense environments because of collisions, huge overhead and large delays. Some other methods allow an AP and a PS STA to schedule a series of times when the STA retrieves data from the AP. The period of the series depends on the QoS requirements.

The tight dependence of these methods with HCCA functionality — specifically with the Traffic Specification (TSPEC) information element which parametrizes QoS requirements — prevents their usage in consumer electronics.

Finally, the 802.11ac amendment [17]–[19] was introduced mainly with the purpose of significantly increasing the data rate of a 10x factor with respect to 802.11n. Besides increasing the number of spatial streams up to 8, 802.11ac addresses the problem of how to cope with terminals that, for obvious manufacturing reasons, could not deploy more than 1 or 2 antennas. To this purpose, the 802.11ac first introduces the DL MU-MIMO, which allows an AP to assign various DL spatial streams to different STAs — the UL MU transmission was postponed to subsequent standards owing to the tight synchronization requirements which would have required a significant re-design. Additionally, 802.11ac widens the transmission bands up to 160 MHz (also exploiting non-contiguous 80+80MHz channels) and increases the constellation order to 256-QAM, which raises data rates up to 7 Gbps. To reduce the header-induced overhead at such high data rates, the amendment increases the maximal length of a frame from 65 535 (802.11n) to 4 692 480 octets. Nevertheless, for short packets, such as instant messages, Web requests, TCP acknowledgments, etc. the channel is still used inefficiently.

### B. Main Features of 802.11ax

Similarly to the previous amendments that improve the nominal bit rates, 802.11ax contains a new PHY protocol with higher modulation and coding schemes. In contrast to 802.11ac, 802.11ax does not increase the number of the MIMO spatial streams and does not widen the channel. Thus the nominal data rates are increased up to 9.6 Gbps, which is just 37% higher than that of 802.11ac (rather small compared to the 10x growth of 802.11n or 802.11ac!) [20]. The desired increase of the user throughput is achieved by more efficient spectrum usage.

The key feature of 802.11ax is the adoption of an OFDMA approach, an approach widely used in cellular networks, but brand new in Wi-Fi. The rationale is that the very wide channels (80 MHz, 80+80 MHz and 160 MHz) introduced by 802.11ac suffer from frequency selective interference, which significantly impairs the practically achievable rates. With OFDMA, adjacent subcarriers (tones) are grouped together into a resource unit (RU) and a sender can choose the best RU for each particular receiver, which actually results in higher Signal-to-Interference-plus-Noise Ratio (SINR), Modulation and Coding Scheme (MCS) and throughput. Moreover, since the efficiency of high data rates degrades when a STA has only few data to transmit, advanced aggregation techniques aimed to reduce channel access, acknowledgment (ACK) and preamble-induced overhead become useless. Allocating narrow RUs for such STAs is an efficient remedy. According to the latest TGax investigations, OFDMA provides a 6 times higher throughput than legacy DCF [21], see Fig. 1.

OFDMA makes Wi-Fi radio access closer to the LTE one. However in contrast to LTE, OFDMA works on top of the legacy DCF and is coordinated by the AP. It means that having

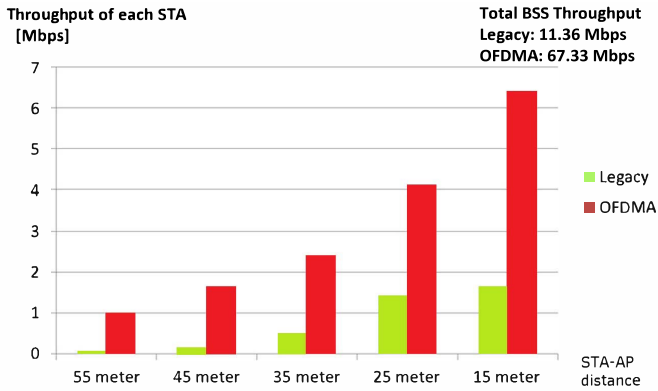

Fig. 1. OFDMA gain in the overlapped network scenario [21].

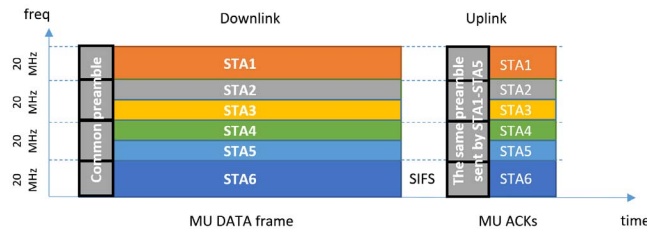

Fig. 2. An example of OFDMA transmission in 802.11ax.

accessed the channel, the AP can start a usual DL transmission, DL MU transmission (using OFDMA, MIMO or both), or allocate RUs for UL MU transmission.

In LTE, OFDMA is time-based, i.e., various tones correspond to different user equipment during one Transmission Time Interval (TTI). In 802.11ax, OFDMA is frame-based, i.e., an MU frame contains data to/from different users and various tones are assigned to the users for the entire frame duration, see Fig. 2.

For a DL MU transmission, a PHY preamble specifies the duration of the frame and the tone mapping between STAs. Conversely, for an UL MU transmission, such a schedule is specified in the preceding frame, which can be either a Trigger frame, a new control frame which allocates the channel for UL MU transmission, or a data frame, the header of which contains scheduling information. The latter is especially useful for acknowledging DL MU transmissions. An UL MU transmission starts exactly one SIFS after the DL frame containing a schedule. This permits to synchronize the STAs participating in the UL MU transmission, whatever techniques the STAs use: OFDMA, MU-MIMO, or both.

Introducing OFDMA in Wi-Fi affects the other MAC and PHY functionality. First, TGax changes the OFDM parameters to improve the flexibility and the efficiency of the OFDMA operations. Second, TGax changes the PHY frame format to include OFDMA-related information in the PHY preamble. Moreover, TGax continues moving MAC-layer information to the PHY preamble, since sometimes the preamble can be decoded even if the entire frame is corrupted. Third, OFDMA causes numerous MAC changes related to the MU operation and the fairness between the devices of different generations.

Apart from OFDMA, many efforts have been put to improve throughput and to decrease power consumption in overlapping and dense networks. The list of the new features includes among others:

- BSS coloring: inherited (and extended) from 802.11ac and 802.11ah, allows to distinguish inter- and intra-BSS frames based on their preambles even if the frame payloads are corrupted by collisions;
- several modifications of the legacy virtual carrier sense, known as Network Allocation Vector (NAV);
- virtualization;
- microsleep operation, which enables a STA to switch off its radio just for the duration of an alien frame;
- redesigned Target Wake Time, originally introduced in 802.11ah; and
- opportunistic power save.

Apart from that, a considerable volume of work has been done to improve spatial reuse in a dense deployment by changing the sensitivity threshold and the transmission power. Actually, to date this topic is still the most debated one in the TGax ongoing activities, since it might significantly influence fairness in the network and degrade the performance of legacy devices.

Finally, TGax reuses the concept of periodic channel reservations during which only predefined STA(s) can transmit. Originally introduced in 802.11s (Mesh coordination function Controlled Channel Access, MCCA) [22] to avoid collisions in mesh networks, the concept is reused by the aforementioned HCCA TXOP Negotiation in 802.11aa, the Periodic Service Periods in millimeter-wave 802.11ad, and the Periodic Restricted Access Window in 802.11ah [23] designed for the Internet of Things. In 802.11ax, periodic channel reservations (namely, the Quiet Time periods) can be used to protect direct link communications. However, the mechanism can also be applied for time division between BSSs in dense deployment.

Table II summarizes the main novel features of 802.11ax which are described in greater detail in the following sections.

### III. PHY: MODULATION AND FRAME FORMAT

#### A. Modulation

The 802.11ax PHY inherits several aspects from its predecessor 802.11ac. Similarly to 802.11ac, it is based on Orthogonal Frequency-Division Multiplexing (OFDM) and supports operations in 20 MHz, 40 MHz, 80 MHz, 80+80 MHz<sup>2</sup> and 160 MHz channels.

To increase the number of tones, which is favorable for OFDMA, TGax has quadrupled the duration of the OFDM symbols used for the PHY payload [24] up to 12.8  $\mu$ s. Such long OFDM symbols are more resilient to the inter-user jitter inherent in outdoor scenarios, which is very important for the UL MU transmission which may be simultaneously performed by several users. Moreover, longer symbols permit to reduce the overhead due to Guard Intervals (GI). Indeed, based on the channel conditions, an 802.11ax device can separate OFDM symbols by the GI selected among the values  $\{0.8 \mu$ s, 1.6  $\mu$ s

<sup>2</sup>In contrast to continuous 160 MHz channel, an 80+80 MHz channel is combined from two non-adjacent 80 MHz channels.

TABLE II  
MAIN FEATURES OF 802.11ax

	Legacy feature	New 802.11ax features
PHY		
Spectrum	up to 40 MHz at 2.4 (11n), up to 160 MHz at 5 GHz (11ac), or up to 16 MHz at 0.9 GHz (11ah)	up to 40 MHz at 2.4, up to 160 MHz at 5 GHz
OFDM Constellation Order	256-QAM (11ac)	1024-QAM
OFDM Symbol duration	3.2 $\mu$ s	12.8 $\mu$ s
OFDM Guard Interval	0.4 or 0.8 $\mu$ s (10 or 20% overhead)	0.8, 1.6 or 3.2 $\mu$ s (5, 10 or 20% overhead)
MIMO Order	4 (11n), 8 (11ac)	8
Maximal Data Rate	$\approx$ 7 Gbps	$\approx$ 9.6 Gbps
Channel Access		
Basic channel access	CSMA/CA	OFDMA on top of CSMA/CA
Random Channel Access	DCF, EDCA	UL OFDMA Random Access on top of CSMA/CA
Contention-free Access	PCF, HCCA (not implemented in real devices), RAW (11ah)	Trigger-based UL OFDMA
MU Technology	MU-MIMO (11ac)	MU-MIMO, OFDMA
MU transmission direction	DL (11ac)	DL and UL
Fragmentation	Static	Flexible
Aggregation	A-MSDU, A-MPDU (11n) without fragmentation	A-MPDU, A-MSDU with Fragmentation
HE/Legacy Fairness		2 EDCA Parameter Sets
OBSS Management		
Interference Mitigation	NAV, RTC/CTS, HCCA TXOP Negotiation	Two NAVs, Quiet Period
Spatial Reuse	Sectorization (11ah)	Adaptive Power and Sensitivity Thresholds, Color
Power Management		
Power Management	Many	Enhanced TWT, Enhanced Microsleep

and 3.2  $\mu$ s}, which allows the reduction of overhead down to 6%, opposed to the 12-25% GI overhead in the 802.11ac standard.

The 802.11ax amendment also introduces new modulation techniques in addition to legacy BPSK, 16-QAM, 64-QAM, and 256-QAM. The first one is an optional 1024-QAM [25], which may be exploited in indoor scenarios with very good channel conditions - i.e., a high SINR. Together with forward error correction codes (convolutional or low-density parity-check) — which have code rates of 1/2, 2/3, 3/4 and 5/6 — these modulations generate a palette of data rates with a maximum of 9.6 Gbps. Such a high rate is achieved when data is transmitted at the highest HE-MCS11 with a code rate of 5/6 in a 160 MHz or 80+80 MHz channel with 8 spatial streams and a GI of 0.8  $\mu$ s.

Additionally, the 802.11ax amendment describes an optional Dual Carrier Modulation (DCM) [26]. DCM enhances transmission robustness by allocating the same signal on a pair of tones, which are separated far apart in the frequency domain. According to preliminary investigations carried out by TGax members, such a technique helps to cope with sub-band interference and provides more than a 2dB gain in the Packet Error Ratio (PER) performance [26]. It should be also noted that because of duplicating data, the usage of DCM reduces the data rate twice, and so DCM is allowed to be used only with the relatively robust MCS0, MCS1, MCS3 and MCS4.

### B. PHY Frame Format

TGax defines 4 types of PHY frames (referred to as PPDU, PHY Protocol Data Unit, following the amendment): for the Single User (SU) transmission, for the extended range SU transmission,<sup>3</sup> for the DL MU transmission and for the UL

MU transmission. These four different frame types leverage a baseline frame structure extended with selected fields specialized for the different frame types (Fig. 3). The main feature of the DL MU transmission is that the frame contains a common preamble describing which tones a particular receiver shall decode to obtain its part of the Data field. Similarly, for the UL MU transmission, the preamble is common and it is emitted by all the STAs. Then, each STA sends its own part of the Data field using a predefined set of tones (see Section IV).

For all the frame types, the preamble is duplicated in every 20 MHz subchannel within the transmission band and consists of two parts: the legacy part and the HE one, see Fig. 4 [28]. While the former is included for backward compatibility, the latter one provides signaling for the new 802.11ax functionality and it can be decoded only by 802.11ax devices.

The legacy part contains training fields, which synchronize the transmitter and the receiver, and the legacy signal field (L-SIG), which describes the parameters of the rest of the frame. Specifically, L-SIG allows the calculation of the frame duration. Even though the legacy devices decode the rest of the frame with errors, they consider the channel as busy, even if the signal strength is too low.

To simplify the 802.11ax frame detection in case of high interference, the HE part of the preamble starts with a repetition of the L-SIG field [29], which is followed by the mandatory HE-SIG-A field, an optional HE-SIG-B field and training fields (HE-STF and HE-LTF) needed for tuning MIMO.

Let us consider the HE-SIG-A and HE-SIG-B fields in more detail. HE-SIG-A provides information about MCS, bandwidth, a number of spatial streams (NSTS) and some other parameters that are needed to correctly decode the rest of the frame. TGax continues moving some MAC signaling to the PHY preamble, an approach indeed widely exploited starting from 802.11ah [23]. Since the preamble has a rather rigid structure and it is transmitted at the lowest MCS, the cost of

<sup>3</sup>An extended range PPDU was designed for robust delivery and can only be transmitted in a 20 MHz channel at one of the three lowest MCSs without MIMO.

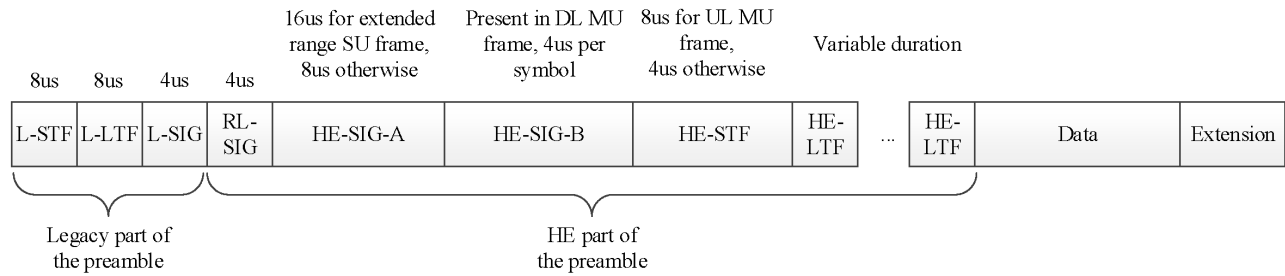

Fig. 3. 802.11ax PHY frame format [27].

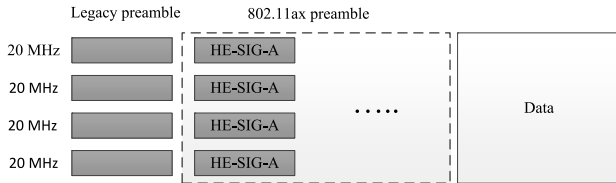

Fig. 4. Legacy preamble and HE-SIG-A are duplicated on each 20 MHz subchannel.

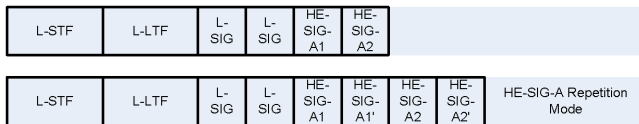

Fig. 5. Repetition mode for HE-SIG-A, [30].

such additional information is high. However, the inclusion of part of the MAC-related information in the preamble is advantageous, since i) the preamble is transmitted with the most robust MCS and ii) it can be decoded before the PHY payload is fully received and its checksum is calculated. Specifically, HE-SIG-A also contains information such as network (or Basic Service Set, BSS, in terms of IEEE 802.11) Color — see Section V-A, remaining Transmission Opportunity (TXOP) duration, whether the frame is sent in UL or DL, etc. Apart from that, HE-SIG-A also contains the spatial reuse parameter (SRP) which is used to signal the sum of transmission power and an acceptable level of interference to allow for the spatial reuse operation as described in Section V.

Since 802.11ax networks are designed for both indoor and outdoor deployment, transmissions are prone to the Doppler effect mainly caused by reflections from fast moving objects, such as cars and trains [31]. To improve the resistance to high mobility, the amendment proposes to periodically insert in the PHY packet payload midambles, i.e., copies of the HE-LTF field. Thanks to midambles, the channel can be estimated not only during the packet preamble, but also continuously throughout the packet which is very fruitful for the high-velocity communications, i.e., when the channel quickly varies.

In case of a  $\geq 40$  MHz channel, the HE-SIG-A field is duplicated on each 20 MHz subchannel. In an extended range variant of the SU frames, the content of HE-SIG-A is repeated after an additional bit interleaving procedure [30].

In case of both UL and DL SU transmission, as well as in a UL MU transmission, all the necessary information can be fitted into HE-SIG-A which consists of two legacy OFDM symbols. However, in case of a DL MU transmission, the information for various users may differ and shall be specified for each of them separately. In this case, an additional HE-SIG-B field of variable length is included in the frame preamble [33], [34]. Specifically, the field contains two blocks: one with common and one with per-user information. The common block describes the OFDMA resource allocation, while the per-user block consists of several subfields defining for each resource unit its MCS, the number of spatial streams, etc.

As mentioned above, the HE-STF and HE-LTF fields are used for MIMO. Specifically, the main purpose of the HE-STF field is to improve the automatic gain control estimation in a MIMO transmission, while the HE-LTF fields provide a tool for the receiver to estimate the MIMO channel between the set of constellation mapper outputs and the receive chains.

Similarly to the legacy PPDU, the Data field contains the SIGNAL subfield needed to initialize the encoder/decoder scrambler and the encoded MAC frame. The Data field is transmitted with 4 times longer OFDM symbols.

Quadrupling the symbol duration means 4 times more calculations at the receiver side, while the time available for the receiver to do such calculations before sending back an acknowledgment or response is limited by the SIFS. This can bring problems for low-cost Wi-Fi devices, which will not be able to generate an acknowledgment in time. A straightforward solution — increasing SIFS — was not approved because of backward compatibility as well because it would have decreased the channel usage efficiency. Rather, TGax provides the possibility to extend the tail of a frame with an extension. To minimize the overhead induced by the extension, its duration is flexible and depends both on the intended frame receiver and the payload size. Specifically, when declaring its capabilities, each STA indicates which maximal extension (0, 8  $\mu$ s or 16  $\mu$ s) is needed to process a frame with a given MCS and a number of spatial streams. Note that this value can be reduced if the encoded payload is not divisible by the OFDM symbol size, and, thus, the last OFDM symbol contains padding. Indeed, the receiver needs less time to decode the bits obtained from such a thin OFDM symbol. In particular, the amendment splits the last OFDM symbol into 4 segments of equal size. Thus, the extension can be reduced from the requested



maximum value by the number of empty segments multiplied by  $4 \mu\text{s}$  [35], [36].

### C. Open PHY Issues

In the course of the past two decades, the 802.11 standardization process has focused on the introduction of new (or improved) functionalities, but it has mostly avoided to determine how to use them. However, the performance of a network significantly depends on how these functionalities are used, and 802.11ax is not an exception. Having extended the set of possible data rates, the amendment also adds new degrees of freedom — such as DCM and shorter GIs — which affect the transmission rate and the reliability. A high number of options complicates the selection of the best rate defined by a set of transmission parameters. Specifically, sophisticated rate control algorithms (e.g., Minstrel [37]) try various MCS, and, having obtained statistics, select the best ones for transmission. A wide palette of 802.11ax options increases the time needed to obtain statistics. Moreover, in 802.11ax dense networks, every 20MHz sub-band may have its own level of interference. Thus, the best rate may be different for various sub-bands. Finally, in 802.11ax networks, the AP not only selects an appropriate rate for its own transmission, but also for the UL MU transmission. For that, it collects reports on signal strength from associated devices prior to allocating UL channel time to them. Although rate control is out of scope of the standard, this problem is of high importance for the vendors, and 802.11ax developers need to revisit again this well-investigated area, owing to the new degrees of freedom and constraints.

Another issue is that the 802.11ax PHY preamble is longer than the legacy one. Thus it should be used only for long transmissions which benefit from the new 802.11ax features. Moreover, since the 802.11ax frames cannot be decoded by legacy devices, virtual carrier sense does not work properly, which can degrade performance in scenarios with hidden STAs. This issue needs to be addressed both by the standard developers (see Section V) and by the community of Wi-Fi researchers, which can design smart algorithms to protect transmissions.

## IV. MU TRANSMISSIONS & CHANNEL ACCESS

### A. 802.11ax OFDMA Fundamentals

Since the design of OFDMA for 802.11 networks is a non-trivial task, it has been investigated in many papers. For example, [38] proposes a novel OFDMA-based MAC protocol called OMAX. Unfortunately, the authors consider only random access. In contrast, TGax has designed a much more flexible and powerful framework, which can be used for both deterministic and random access. Let us describe it in detail.

In 802.11ax, the channel resources are allocated over time and frequency, but in order to simplify resource management and device operation, and to retain compatibility with legacy devices, the OFDMA transmission is organized on a per-frame basis. This means that a frame can carry information from or to multiple STAs. In such a frame, various tones are assigned

TABLE III  
THE MAXIMUM NUMBER OF RUS FOR EACH BANDWIDTH

RU type	20 MHz	40 MHz	80 MHz	160 (80+80) MHz
26-tone	9	18	37	74
52-tone	4 <sup>+1</sup>	8 <sup>+2</sup>	16 <sup>+5</sup>	32 <sup>+10</sup>
106-tone	2 <sup>+1</sup>	4 <sup>+2</sup>	8 <sup>+5</sup>	16 <sup>+10</sup>
242-tone	1	2	4 <sup>+1</sup>	8 <sup>+2</sup>
484-tone	NA	1	2 <sup>+1</sup>	4 <sup>+2</sup>
996-tone	NA	NA	1	2

\*<sup>+n</sup> means “plus  $n$  26-tone RUs”.

to different STAs but the duration of all the RUs within such a frame is the same.

An RU can contain 26, 52, 106, 242, 484, 996 or 2x996 tones (including service ones). The entire 20 MHz band, 40 MHz band, 80 MHz band and 80+80 (160) MHz band corresponds to a 242-tone RU, 484-tone RUs, 996-tone RUs and two 996-tone RUs, respectively. Each wide RU can be split into two approximately twice-narrower RUs. In turn, each of them can be split again, separately from another one. The only exception is that a 242-tone RU can be replaced by two 106-tone RUs and one 26-tone RU. Because of various problems with binary convolutional codes, see a description in [39], multiple RU allocations for a STA are forbidden. Even though MU-MIMO and OFDMA can be used together, both UL and DL MU-MIMO shall be performed only in  $\geq 106$ -tone RUs. The maximum number of RUs for each bandwidth is indicated in Table III.

Thanks to MU-MIMO, up to eight users can be assigned to an RU. It is also possible to allocate up to four spatial streams per user, if the total number of spatial streams does not exceed eight.

Let us consider how the DL and UL OFDMA transmissions are organized. In the case of the DL OFDMA transmission, the HE-SIG-B field of the common preamble contains an RU allocation map which is followed by per-user content fields indicating the RUs assigned to an STA and the transmission parameters to be used by the STA (NSTS, MCS, coding, etc). Note that an RU can represent either an SU or an MU-MIMO allocation. In the latter case spatial configuration shall be also signaled to the STA.

Organizing the UL MU transmission is a more challenging task. MU transmissions in Wi-Fi shall be synchronized in the time domain. Since it is difficult to maintain strict time synchronization because of clock drifting, an AP coordinates the UL MU transmission as follows. The AP transmits a new type of a control frame — Trigger frame — in which it specifies the common parameters of the upcoming UL MU transmission (duration, GI which shall be the same for all the STAs participating in the UL MU transmission [40]), allocates RUs for the STAs, and defines transmission parameters for each particular STA (MCS, coding, etc.). To achieve synchronization, the MU transmission is performed immediately, i.e., a SIFS after the Trigger frame [41], see Fig. 6. Since it may take more than SIFS to prepare a UL transmission, the AP can pad the Trigger frame [42].

For UL MU OFDMA transmissions, the AP shall receive signals from different STAs at almost the same power level.



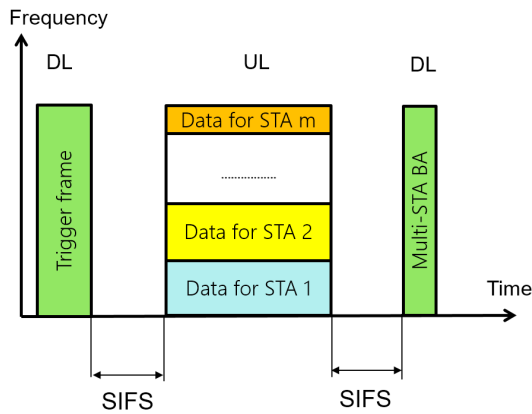

Fig. 6. An example of UL OFDMA transmission.

For that, 802.11ax defines a power pre-correction mechanism, according to which the AP indicates in the Trigger frame its current transmit power and the target signal strength that the AP is expected to receive from a STA in the following UL transmission. Thus, having known the AP's transmit power and the signal strength of the received Trigger frame, the STA can estimate the path loss to the AP and it can calculate an appropriate transmit power for the following UL transmission. Note that since the AP (not an STA!) selects the MCS for the UL transmissions, each STA also includes information about its UL power headroom, i.e., the difference between its maximum transmit power and its current transmit power for the assigned MCS.

In order to be efficient, the AP shall allocate RUs only to STAs which have data to transmit. For that, STAs report to the AP the amount of buffered data they have. Such reports may be requested by the AP or sent by STAs on their own [43]. Another challenge arises because the AP does not know whether the channel is idle from the STA's point of view. For each STA, the AP specifies in the Trigger frame whether the STA shall perform carrier sensing before an OFDMA transmission or not. If carrier sensing is required, the STA shall perform both *virtual* carrier sensing and *physical* carrier sensing in at least the 20 MHz channel(s) that contain(s) subcarriers allocated for the STA. If *physical* carrier sensing indicates busy medium, i.e., the STA detects high energy, it cancels the UL transmission. The UL transmission is forbidden even if some but not all the subcarriers are idle. However, in some cases the STA can neglect *virtual* carrier sensing, i.e., NAV, if it has been set by a frame originating from an intra-BSS neighbor or the STA is going to transmit ACK or BlockAck which duration does not exceed some agreed value. However, the STA always cancels the UL transmission if its duration exceeds the UL MU transmission duration indicated in the Trigger frame.

### B. Performance Improvements

802.11ax also allows performing a UL MU transmission just after a DL MU transmission, which can be useful, e.g., for sending acknowledgment frames simultaneously. For that, the DL MU transmission shall also contain the Trigger frame describing the UL RU allocations. Moreover, there is another

possibility to solicit a UL MU transmission in this case, namely by including information in the DL PPDU MAC header. Similarly, the AP can acknowledge a UL MU transmission by sending acknowledgments via a DL MU PPDU. Following the described ideas, 802.11ax also implements cascading MU transmissions which means that within a TXOP, DL MU and UL MU transmissions can alternate. Note that within cascading MU transmissions the AP can exchange frames in an MU manner with different sets of STAs.

MU transmissions in Wi-Fi shall be aligned in the time domain. Thus, if a STA has a short frame to transmit, it either uses padding or tries to aggregate it with another frame. In case when the remaining space is not enough for aggregating the whole frame, padding is the only option. To avoid wasting channel resources, 802.11ax STA is allowed to fragment frames in order to fill the remaining airtime with user payload<sup>4</sup> [44]. To improve the efficiency even more, the 802.11ax STA can also aggregate frames from different Access Categories (ACs) [45]. A similar approach is used in the 802.11ac DL MU MIMO [19, Sec. 9.19.2.3a].

Since the aggregation of several fragments is complicated, TGax has found a compromise, having defined several optional levels of HE fragmentation. The first level permits to send only one fragment without any aggregation. The second level allows a STA to aggregate not more than one fragment per MSDU in an A-MPDU. Finally, the third level allows the aggregation of two or more fragments per MSDU in an A-MPDU [46].

### C. Special Trigger Frames

OFDMA permits to cope with frequency selective interference by assigning the best subcarriers for STAs. Apart from that, it reduces the overhead caused by backoffs, inter-frame spaces, preambles and PHY headers, which carry common information for all the STAs in case of a DL transmission. The overhead is higher for short control frames, for which OFDMA is especially favorable. Thus, in addition to the basic Trigger frame for data and management frames, 802.11ax has special Trigger frames which initiate parallel Request To Send / Clear To Send (RTS/CTS) handshakes, request block acknowledgments from a group of STAs, and collect beamforming reports or buffer status reports (BSR). Let us consider how these frames are used in detail.

To protect a DL MU transmission from hidden nodes, TGax introduces the MU-RTS/CTS handshake [47]. Thanks to the UL MU transmissions in 802.11ax, the CTS frames can be sent simultaneously. The main peculiarity of the MU-RTS/CTS frames is that a CTS frame is transmitted on the primary 20 MHz, 40 MHz, 80 MHz or the entire 160 MHz or 80+80 MHz channel being duplicated on each 20 MHz sub-channel using the legacy CTS frame format. The channel which shall be used by a particular STA to transmit the CTS is determined in MU-RTS and shall contain all the subcarriers which will be used for the following transmission to the STA. It is done to set NAV at all legacy STAs which receive

<sup>4</sup>Note that in legacy Wi-Fi, STAs use fragmentation only when the frame size exceeds the fragmentation threshold. Moreover, the joint usage of aggregation and fragmentation is explicitly forbidden.

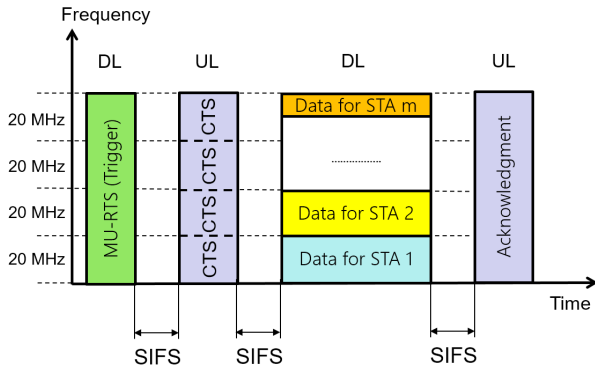

Fig. 7. An example of an MU-RTS/CTS exchange.

this CTS, and thus to protect the transmission from collisions. The protocol allows several receivers to transmit CTS frames simultaneously, however these CTS frames are absolutely equal from a PHY perspective, thus they do not collide, see Fig. 7. Nevertheless, such an approach has an important limitation. Having received several equal CTSs in the same channel, the AP cannot obtain information which receiver(s) sent the CTS. Such a limitation may force the AP either not to plan parallel transmissions which occupy subcarriers from the same 20 MHz channel, or to ignore the fact that some recipients may not answer with CTS. Since both the workarounds may degrade performance, currently TGax is looking for a better solution [48].

The 802.11ax amendment proposes an additional way for acknowledging UL MU transmissions by sending new Multi-STA Block ACK (BA) frames. Similarly to the existing Multi-TID BA frame which is used to acknowledge a set of frames from various ACs, a Multi-STA BA frame is used to replace ACKs or BAs to several STAs [49], [50]. To shorten transmission, a Multi-STA BA frame can be sent in a legacy manner with only a legacy 802.11a preamble. A Multi-STA BA can act as a BA or as an ACK.

Another new frame defined in 802.11ax is the MU Block ACK Request (BAR) frame which is a variant of the Trigger frame. It is used to solicit acknowledgements from multiple STAs in the UL MU transmission instead of sending individual BAR frames [51]. Similarly, 11ax defines GCR MU BAR to poll acknowledgments for groupcast transmission with retries, a novel groupcast method introduced in 11aa. In addition to the acknowledgment, a recipient of an MU-BAR frame can transmit another data or management frame if it does not exceed the indicated UL MU duration [52].

One more variant of the Trigger frame is used to collect BSRs. In each BSR, each STA informs the AP about the amount of buffered traffic in a queue of the requested AC (AC\_BE, AC\_BK, AC\_VI, or AC\_VO) or of a subset of ACs.

Finally, 11ax defines special Trigger frames used to poll beamforming information or to request information about the channel.

#### D. UL OFDMA Random Access

Besides the scheduled UL MU access described above, TGax has designed an optional mechanism which allows

performing random UL OFDMA transmissions [53]. Such a feature is especially important when the AP does not know which associated STAs have data to transmit, or when an unassociated STA wants to transmit an association request. DCF/EDCA is not efficient for short transmissions because of the large overhead caused by PHY headers and interframe spaces.

The designed random access is similar to the multichannel slotted Aloha. Specifically, a Trigger frame can allocate some RUs for random access. Specifically if the user identifier for some RU is 0 or 2045, the corresponding record in the Trigger frame defines a group of contiguous RUs for random access which can be used by associated and unassociated STAs correspondingly. The RUs of a group are of the same size and have the same transmission parameters. Along with the number of contiguous RUs, the AP can indicate that no other RU for random access is planned in the series of cascading MU transmissions till the end of TXOP.

To decide whether to transmit and in which RU, STAs use the so-called OFDMA Back-off (OBO) procedure [54]. Each STA chooses a random value from  $[0, OCW]$ , where  $OCW$  is the OFDMA contention window. If the current OBO value is less than the number of RUs allocated for random access by a Trigger frame, the STA randomly selects an RU from those allocated for random access and transmits a frame in this RU. Otherwise, the STA decreases OBO by the number of RUs allocated for random access and waits for the next Trigger frame containing RUs for random access.

If the transmission attempt fails, the STA doubles its  $OCW$  until it reaches  $OCW_{MAX}$  and selects an OBO value from the new interval. If the transmission attempt is successful, the STA resets its  $OCW$  to the minimum value  $OCW_{MIN}$ . Both  $OCW_{MAX}$  and  $OCW_{MIN}$  are specified by the AP in beacons and in the probe response frames.

Since random access is less efficient than scheduled access, it is worth to use it only for short packet transmissions and for BSR. In the latter case, a STA having data for transmission can generate a BSR and send it with random access to ask the AP for channel resources. It is clear that such a scheme turns out to be more efficient than pure UL OFDMA Random Access, as confirmed in [55]. Nevertheless, some results from [55] are preliminary, so the performance evaluation of such a scheme is a topic for future research.

#### E. EDCA Improvements

In 802.11ax networks, OFDMA works on top of the legacy CSMA/CA (Carrier Sense Multiple Access With Collision Avoidance) mechanism called EDCA or DCF.<sup>5</sup> It means that to transmit a Trigger frame, the AP shall contend for the channel with other STAs. Consider a network with an AP and several STAs having UL traffic. Since the number of STAs is usually much higher than one, the AP rarely wins the contention if the AP uses the same channel access parameters. However, when the AP succeeds, it sends a Trigger frame to allocate resources for the associated STAs. As shown in Section II-B,

<sup>5</sup>Since both methods are well-known and widely analyzed in the literature (see [56], [57]), we do not describe them.

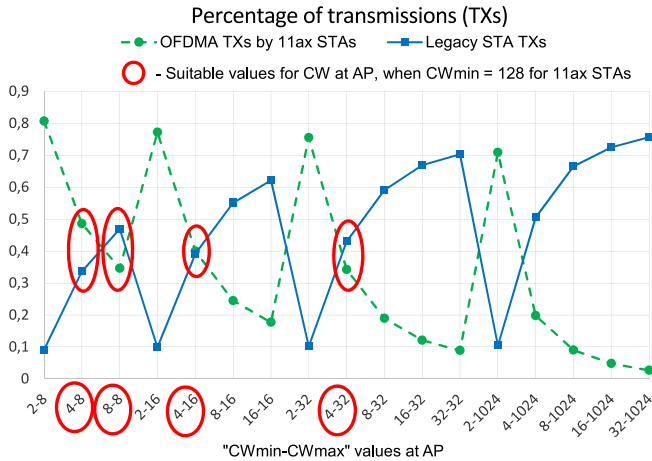

Fig. 8. Percentage of OFDMA UL MU transmissions and legacy STAs transmissions vs. the AP CW parameters [58].

OFDMA is much more efficient than EDCA. So, to achieve higher throughput, the STAs should rarely access the channel with EDCA but they should almost always use OFDMA. In other words, the AP shall almost always win the contention.

Fortunately, the AP can change the EDCA parameters for all the associated STAs by broadcasting them in beacons. So, by setting high values for  $CW_{min}$  and  $CW_{max}$ , the AP can almost forbid EDCA transmissions in the network.

A problem arises, if there are some legacy STAs in the network which cannot use OFDMA transmissions. Since the EDCA parameters cannot be set individually, setting the same high values of  $CW_{min}$  and  $CW_{max}$  for both 802.11ax and legacy STAs will block the legacy STAs. This may lead to a situation, when the performance of the legacy clients significantly degrades. Another problem is related to a misbehaving AP, which allocates less RUs for a client of a concurrent vendor. To avoid such problems, TGax introduces the second set of EDCA parameters which is used *only* by those 802.11ax STAs which were granted RUs during some preceding time interval.

Fig. 8 presents numerical results for a scenario with a network with ten legacy STAs and ten 802.11ax STAs.  $AIFS_N$  is the same for all devices. Legacy STAs use the default  $CW$  limits:  $CW_{min} = 16$ ,  $CW_{max} = 1024$ . For 802.11ax STAs,  $CW_{min} = 128$ ,  $CW_{max} = 1024$ , while the  $CW$  limits of the AP vary. Fig. 8 shows that by tuning the EDCA parameters, we can make sharing channel resource both fair and efficient, i.e., 802.11ax STAs almost always use OFDMA transmissions, while legacy STAs obtain as much channel time as in a pre-802.11ax network. Such suitable values of  $CW_{min}$  and  $CW_{max}$  at the AP are marked with red ovals in Fig. 8. The usage of different EDCA parameter sets is studied in more detail in [59].

TGax has also improved the RTS/CTS mechanism which helps to mitigate collisions from hidden nodes and reduces collision duration. Historically, the use of the RTS/CTS mechanism is determined by the length of the transmitted data frame. If the frame length exceeds the RTS threshold then

the data transmission is preceded by an RTS/CTS handshake. TGax has proposed an alternative RTS/CTS mechanism which has two major distinctions. First, the use of the mechanism is determined by the *duration* of the transmission rather than by the *length* of the frame, explaining the name of the mechanism — duration-based RTS/CTS threshold. It is more natural to focus on the duration of the transmission rather than on the packet length, because with a high MCS even a rather long frame can be transmitted fast enough, which finally yields a relatively high overhead caused by the RTS/CTS handshake performed with a slow MCS. Second, the value of the duration-based RTS/CTS threshold is under the control of the AP which can have a better view of the network situation and it can signal the threshold value to associated STAs. In such a way, the AP can lower the threshold if interference from hidden nodes is suspected in a dense environment or increase it otherwise to reduce the transmission overhead and optimize the usage of network resources.

#### F. Open MU & Channel Access Issues

Having introduced OFDMA, Wi-Fi developers made Wi-Fi similar to LTE. Obviously, this means that all the issues relevant to channel resource allocation in LTE became relevant to Wi-Fi. However, resource allocation in Wi-Fi is much more difficult than in LTE for the following reasons.

First, traditional LTE networks operate in license bands. This means that an operator can control interference from neighboring cells and adjust inter-cell interference to achieve better performance. In contrast, Wi-Fi networks operate in license-exempt bands where nobody can guarantee the interference level in future. This complicates channel quality estimation and makes Wi-Fi developers design sophisticated algorithms to reduce interference, see Section V.

Second, in LTE networks the channel is divided into resource blocks of equal size. For the downlink channel, the base station can select an arbitrary subset of resource blocks to transmit some data for a user. For the uplink, the resource blocks in the subset need to be contiguous. In Wi-Fi, the restrictions on possible RUs are more sophisticated, which complicates the development of optimal schedulers, i.e., algorithms which allocate RUs for each STA in order to maximize some utility function.

Third, for UL transmissions, Wi-Fi allows the increase of the power spectral density if the STA transmits in a narrow RU. Specifically, the STA can transmit with the same power whatever RU it uses. Note that since the STAs are located in different places, it does not violate the energy emitting constraints but brings much benefit. Indeed, the higher the power spectral density, the higher MCS can be used. On the first sight, this means that each Trigger frame shall allocate RUs for all the STAs which have data in the uplink channel. However, after some investigation it becomes clear that the problem is much more difficult. The first issue is that according to the standard the highest MCSs cannot be used with 26-tone RUs. Thus by splitting the channel into too narrow RUs we may obtain a lower throughput. The second one is the impossibility of splitting some channels into a given number of RUs.



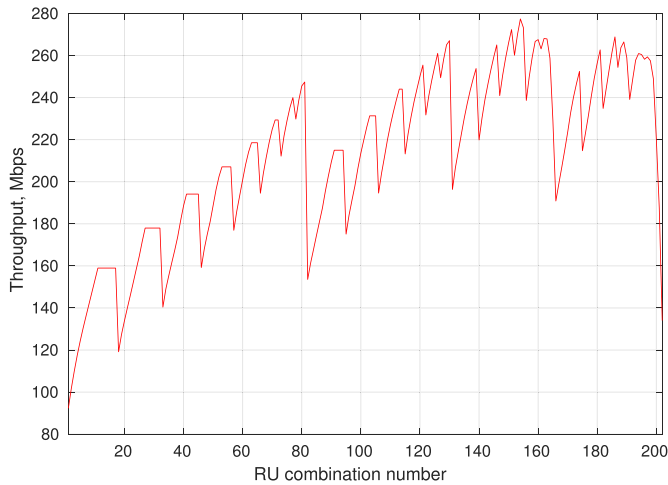

Fig. 9. UL throughput with various RU configuration.

For example, in case of three STAs with UL traffic, the AP can divide a 40 MHz channel into two RUs (242-tone + 242-tone) or into four RUs (242-tone + 2x 106-tone + 26-tone), but not into three RUs. This means that a 26-tone RU is wasted. Fortunately, such small RUs are favorable to be allocated for buffer status reports transmitted with random access. Some studies show that there is no straightforward solution for the RU allocation and an optimal allocation of RUs depends on the device location.

Fig. 9 shows the UL throughput in an 802.11ax saturated network operating in a 80MHz channel with ten STAs uniformly located in a circle of radius 35 m around the AP. The resources are allocated in a proportionally fair manner with the optimal static division of the channel into RUs. The horizontal axis represents all the possible combinations of RUs in lexicographical order. The left combination, i.e., combination #1, represents a case when there are zero 996-tone RUs, zero 484-tone RUs, ... and 37 26-tone RUs. Combination #2 represents a case with one 52-tone RU and 35 26-tone RUs. Combination #3 has two 52-tone RUs and 33 26-tone RU. Finally, the right combination stands for the case with the only 996-tone RU. The results show that the average throughput significantly depends on how the channel is divided into resource units. Although in all these cases the RUs are assigned according to the same policy — proportionally fair — the efficiency of channel resource usage varies more than two times. Thus, even in the case of a baseline utility function (e.g., the geometric average of the throughputs which gives a proportionally fair resource allocation), the selection of the best RU allocation scheme is very sophisticated (see [60]). To a greater extent, this will be the case with other more complex QoS-aware schedulers, like M-LDWF [61] and EXP-PF [62].

Fourth, a portion of RUs shall be allocated for the RA. Obviously, the number of RUs allocated for the RA affects the latency and the network capacity and shall be selected based on some estimation of the traffic patterns. Note that in the case of arrival of packets for uplink transmission, the STA can use the legacy EDCA to transmit either these packets or BSR. However, a) such transmissions are less efficient than

the OFDMA ones, and b) because of the EDCA parameters transmitted by the AP, the time needed to access the channel with EDCA is much longer than that with OFDMA.

Fifth, a Wi-Fi network consists of devices produced by various manufacturers. In the legacy Wi-Fi, all the STAs in the network should use the same channel access parameters broadcast by the AP. Thus, all the devices have the same opportunity to transmit.<sup>6</sup> In an 802.11ax network, the channel resources are allocated by the AP. So a misbehaving AP can allocate more channel time to those STAs which are produced by the same vendor. The methods of detecting such misbehaving APs should be a subject of further investigation.

Sixth, an open issue is how to select an appropriate duration of an MU frame. This may affect the efficiency of the channel usage as well as the fairness and the QoS. Moreover, an AP shall find a trade-off between long frames favorable for heavy data traffic and short frames efficient for random access and for BSR.

## V. OVERLAPPING BSS MANAGEMENT AND SPATIAL REUSE

Since the dense deployment scenario is the main one for TGax, there are a lot of debates on how to improve the performance in case of dense networks. On the one hand, TGax wants to decrease interference between networks, but, on the other hand, it wants to allow spatial reuse, i.e., simultaneous transmissions in overlapping networks to increase total throughput. A considerable activity is related to carrier sensing, dynamic sensitivity thresholds and dynamic transmission power control. Since the launch of TGax, about one hundred submissions on these topics were proposed, most of which were rejected. Here we describe the accepted ones briefly.

### A. BSS Color

To determine which BSS is the originator of a frame without decoding the entire frame, 802.11ax uses the non-unique ID of the BSS, called the BSS color [63], which is transmitted in the frame preamble. Initially, the BSS color field of 3 bits length appeared in 802.11ah to reduce power consumption, because the receiver can stop decoding a frame coming from an alien BSS. Since the BSS color is selected randomly by the AP, the colors of two neighboring BSSs may coincide or collide in terms of 802.11ax. To decrease the BSS color collision probability, TGax has agreed to increase the length of the BSS color field to 6 bits [64]. If the collision occurs, the STAs associated to an AP can notify it about collision and the AP can start a procedure of changing its BSS color. For that, it advertises the future BSS color and the moment when the color will be changed by sending special information element in beacons. So all the STAs, even dozing ones can obtain information about the change of BSS color.

The identification of a BSS by the BSS color field is used for determining channel access rules and for power saving

<sup>6</sup>Although having been standardized, the centralized channel access methods, such as PCF or HCCA, which allow the AP to poll the STAs are not used in out-of-the-shelf devices because of their extreme implementation complexity and some flaws in the behavior in dense deployment.

mechanisms. To disable the BSS color for a particular frame, the BSS color field of this frame is set to zero.

### B. Two NAVs

The Wi-Fi channel access follows the listen-before-talk principle, i.e., a STA performs carrier sensing before transmitting a frame. The channel is supposed to be busy in the following cases.

- 1) If during carrier sensing a STA detects a frame preamble, it considers the channel as busy for the frame duration that is signaled in the preamble.
- 2) If during carrier sensing a STA detects an unknown signal at more than 20 dBm above the minimum sensitivity level.
- 3) If the channel is indicated to be virtually busy.

The virtual carrier sensing in Wi-Fi, called NAV, is organized as follows. In the MAC header, a STA indicates the NAV value, i.e., for how long the following frame exchange will occupy the channel. Having correctly decoded the frame, the other STAs set NAV, i.e., they consider the channel to be busy during the indicated time. If a STA receives a frame indicating a larger NAV value, it increases its NAV, but the STA does not decrease NAV even if the indicated NAV value is smaller. The STA cancels its NAV, if it receives a CF-End frame.

In the legacy Wi-Fi, STAs do not take into account by which frame the NAV value was set. However, this may lead to the following misbehavior. Suppose a frame from the same BSS sets the NAV value at a STA. After that, the STA receives a CF-End frame coming from an Overlapping BSS (OBSS). According to the existing rules, the STA will reset the NAV and it will not consider the medium to be virtually busy anymore. Since the STA may not hear an ongoing transmission that was protected by NAV, it can start its own transmission which causes a collision. As dense deployment was not a common scenario earlier, such a situation was not extensively researched. However, this reasoning is no longer true for 802.11ax networks. Thus, to prevent resetting NAV by CF-End from an OBSS, 802.11ax STAs will support two NAVs: one for their own BSS and the other for all the OBSSs, and they will modify the NAVs separately [65].

### C. Quiet Time Period

Ad Hoc and direct links<sup>7</sup> operation are promising solutions that reduce the channel busy time. However, such operations in the proximity of an 802.11ax network can increase the overall interference and cause significant performance degradation. To address this problem, the 802.11ax amendment defines the Quiet Time Period (QTP) mechanism. QTP allows a STA to request the AP for a QTP which is a series of periodic time intervals of equal duration used for ad hoc or direct links operation. The QTP is described by the offset of the first reserved interval, the duration and period of the intervals, and the total number of requested intervals. If the AP satisfies the request, it

disseminates information about the reserved QTP and forbids the other STAs to access the channel during QTP.

This mechanism has been proposed rather recently, so its description contains many open issues which should be addressed in the very near future. Specifically, the standard describes the only way — which is defined as optional but without an alternative — to disseminate information about QTP: at the beginning of a reserved time interval, the AP broadcasts information about its duration and type of operation which is allowed during the interval. Such a behavior has several drawbacks. First, the information is broadcast only once, so it can be lost. Second, the type of operation does not identify the set of STAs which can access the channel during the interval. Finally, there is not any explicitly defined mechanism to silence legacy STAs which ignore novel 802.11ax messages.

### D. Adjustment of Sensitivity Threshold and Transmit Power

A possible solution to improve spatial reuse in a dense deployment environment is by tuning carrier sensing mechanisms [66], e.g., by means of using Dynamic Sensitivity Control (DSC). The idea of DSC is based on the dynamic adjustment of the carrier sensing threshold referred to as the DSC threshold, which determines when the STA considers the medium to be busy. Obviously, to prevent transmissions within a BSS from being blocked by an OBSS, the DSC threshold should be increased. Nevertheless, to allow communication between all devices within a BSS, the DSC threshold shall be small enough not to miss a transmission within this BSS.

Smith [9] and Afaqui *et al.* [67] propose to set the DSC threshold at the STAs to  $TxPower - \max_{i \in BSS} PassLoss(AP, i) - MRG$ , where  $TxPower$  is the AP's transmit power,  $PassLoss(AP, i)$  is the signal attenuation between the AP and STA  $i$ , and  $MRG$  (margin) is a tunable parameter with a recommended value in the range (18, 25) dB. Since it may be difficult to obtain the AP's  $TxPower$  and to estimate attenuation, the authors propose the following practical implementation. Each STA maintains the average received signal strength indicator (RSSI) value ( $AvgRSSI$ ) of beacons received from the AP and set the DSC threshold to  $AvgRSSI - MRG$ . However, the attenuation may increase so that the signal strength from the AP's beacon will be less than  $AvgRSSI - MRG$ , and the STA will start to ignore beacons. To prevent such an undesirable behavior, it is proposed to decrement  $AvgRSSI$  by  $RSSIDEC$  dBs (some constant value) if several beacons are lost in a row and, thus, to automatically decrease the DSC threshold. The authors vary the  $MRG$  and the  $RSSIDEC$  parameter values to evaluate the efficiency of the proposed scheme in terms of aggregated throughput, fairness (calculated according to Jain's fairness index), the number of hidden nodes, and PER (Fig. 10). The results show the increase of these metrics observed with DSC, compared to the legacy constant carrier sensing threshold. Thus, the gain in throughput and fairness is achieved at the cost of a higher number of hidden nodes and, consequently, of a higher PER. On the one hand, it is natural to think that DSC may decrease fairness, because close to the AP STAs set a higher

<sup>7</sup>Direct links allow two STAs associated with the same AP to communicate directly without using the AP as a relay.

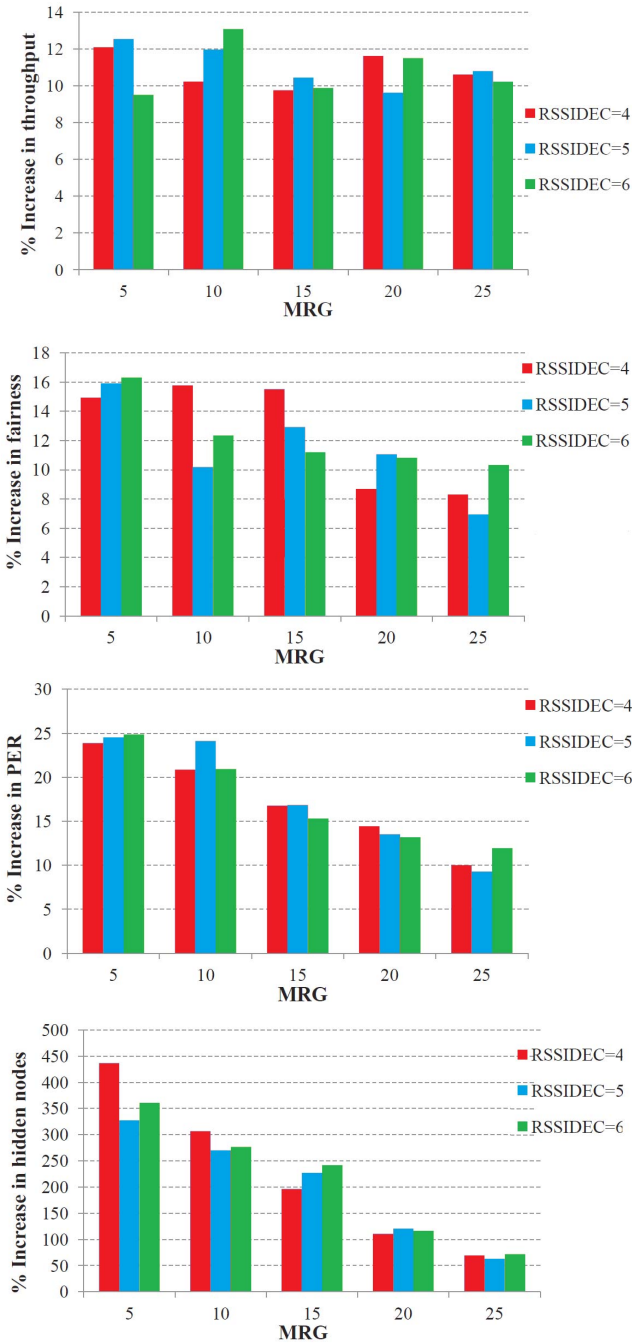

Fig. 10. Increase of Throughput, PER, and the number of hidden nodes, with DSC [67].

DSC threshold and have more chance to transmit a packet. However, DSC reduces the number of exposed nodes which allows the achievement of a gain in fairness. Having analyzed the results, the authors recommend setting *MRG* to 20 and *RSSIDEC* to 6.

Having reduced the number of exposed STAs, DSC increases the number of hidden STAs. To address this issue, various methods have been proposed. One of them is using the RTS/CTS mechanism together with DSC. This approach is evaluated in [68] and it has been proved to be effective. In [69], the DSC approach is combined with inter-BSS

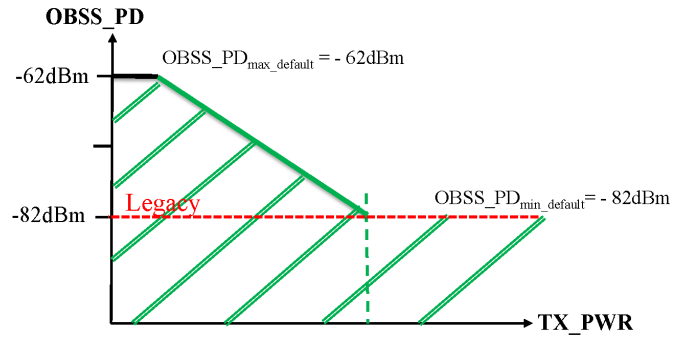

Fig. 11. Illustration of *OBSS\_PD* and *TX\_PWR* adjustment in a 20MHz channel [27].

TDMA (Time Division Multiple Access) which makes transmissions of OBSSs orthogonal in the time domain if they severely interfere with each other. Although DSC with TDMA are opposite approaches and have opposite goals, the authors show that combining DSC and TDMA demonstrates the best performance, simultaneously increasing the average and the worst throughput. Unfortunately, the implementation of inter-BSS TDMA is too complicated and requires a tight synchronization between the OBSSs. So the approach was not approved by TGax.

To balance between spatial reuse and collision avoidance, TGax decides to bind changes in the sensitivity threshold for the OBSS frames (named as *OBSS Preamble Detection threshold*, *OBSS\_PD*) and the transmit power (*TX*) according to a simple rule: the higher the *OBSS\_PD*, the lower the *TX*. Such a rule has a simple explanation. By default, an STA transmits signals of power *TX\_PWR* and considers the medium to be idle if the signal strength is less than  $OBSS\_PD = -82$  dBm. Let the STA receive a signal from an OBSS STA *X* dB stronger than  $-82$  dBm. This means that the attenuation between the STA and the OBSS STA is *X* dB weaker than necessary for considering the medium idle. If the STA wants to start a new transmission in this case, it shall first increase its *OBSS\_PD* by *X* dBm, and second, it shall decrease its transmit power also by *X* dB in order not to produce a huge interference at the location of the OBSS STA (Fig. 11).

STAs may dynamically change their *OBSS\_PD* and *TX\_PWR* parameters. During backoff, a STA sets up its *OBSS\_PD* to some value. Every time, it senses the start of a packet it suspends its backoff. Right after the STA understands that this packet belongs to OBSS, it can resume backoff even before the end of the packet, if the signal strength is less than *OBSS\_PD* and no other conditions (e.g., NAV) require the channel to be considered as busy. When the STA obtains channel access, it can start transmission with the power not higher than that corresponding to the used value of *OBSS\_PD*. Such a power level is used till the end of TXOP.

The AP may specify the colors of the OBSSs for which the described rule is applied. To achieve the maximum benefit from spatial reuse, the rule should be applied for such BSSs, the signal from which is much lower than that from associated STAs. Obviously, an algorithm on how to make a decision is beyond the scope of the standard.



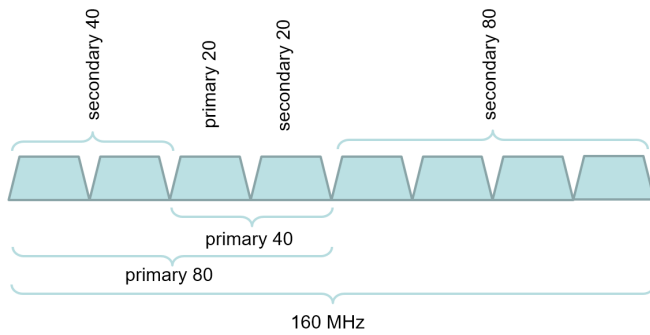

Fig. 12. Primary and secondary channels in 802.11ac networks.

Another option allowing spatial reuse operation is related to Trigger frames. Specifically, the AP may allow an alien transmission to overlap with the UL transmission in its own BSS, if the received signal from such an alien transmission does not exceed some acceptable level of interference. Such an acceptable level of interference depends on the current interference in the channel near the AP and on the used MCS. To allow an overlapped transmission, in the Trigger frame the AP specifies the spatial reuse power  $S$  as the sum of its transmit power plus the acceptable level of interference minus some margin. Having received the Trigger frame at some power  $R$ , an OBSS STA can start a transmission with power  $S - R$  after the end of the trigger frame if such a transmission does not exceed the end of the scheduled UL transmission. Naturally, to access the channel, the OBSS STA needs to use backoff, resuming it after the end of the Trigger frame and ignoring the upcoming UL transmission.

### E. Channel Bonding and Preamble Puncturing

In 802.11ac, STAs can adaptively select the bandwidth in which a particular frame is transmitted. Specifically, the standard defines a hierarchy of channels shown in Fig. 12. Having obtained channel access in the primary 20 MHz channel following the EDCA rules, a STA can expand the bandwidth by step-by-step concatenation of the secondary channels if they are idle. In other words, if the secondary 20 MHz channel is idle, the STA can transmit in 40 MHz bandwidth. If both the secondary 20 MHz and the secondary 40 MHz channels are idle, 80 MHz bandwidth can be used. In contrast, even if the secondary 40 MHz channel is idle but the secondary 20 MHz channel is busy, the STA can only transmit in the primary 20 MHz channel. This limitation is especially crucial for dense networks, where the secondary 20 MHz channel of a BSS can be the primary 20 MHz channel of another one.

To improve the efficiency of channel bonding in dense environment, 802.11ax introduces a new optional feature called preamble puncturing. For an MU OFDMA transmission in a channel greater than or equal to 80 MHz, one or more busy 20 MHz subchannels can be punctured. It means that frame preamble is not transmitted and RUs are not allocated in these subchannels. In dense deployment, such a feature allows using channel resources in a much more flexible way.

### F. Virtualization

One of the widespread features in modern APs is the support for multiple “virtual” APs (VAPs). This means that a single physical device can create multiple independent BSSs, reaching up to 32 VAPs in some equipment. This may be useful, when, for example, one wants to separate a guest Wi-Fi network from an internal corporate network without installing an additional AP. One of the shortcomings of the existing VAPs is that a lot of service information for all VAPs may be the same, but it is transmitted separately by each of them. To decrease the overhead, the 802.11ax amendment introduces the Multiple BSSID support, which allows the sending of identical information for all the BSSs simultaneously [70], e.g., via a common beacon. All the BSSs in the multiple BSSID use the same BSS color, and the frames of BSSs from a Multiple BSSID set are considered as intra-BSS frames [71].

### G. Load Balancing

In dense networks, load balancing is an important problem, since every STA has several candidate APs to associate with. Although the problem has attracted considerable interest among the researchers, it is out of scope of the standard, since the decision on association is done by vendor specific algorithms. In [72], some algorithms are studied in the context of 802.11ax.

### H. Open Issues With Dense Deployment

For several years, the group has been debating about the methods which could improve performance in scenarios with overlapping networks. Some solutions have been pushed into the standard by several so-called special interest groups (SIGs) which usually come to an agreement outside the IEEE 802 sessions making it difficult to accept other ideas proposed by independent members not involved in SIGs. At the end of 2016 there was an investigation [73] which revealed a violation of IEEE rules and ceased the operation of SIGs. Nevertheless, the question what to do with all the accepted proposals remains open.

Since the most severe debates were associated with the solutions that improve performance in scenarios with overlapping networks, there is a strong need now for an independent study on whether the accepted proposals can indeed improve performance, and in which scenarios. This can be a fruitful research area.

This task is complicated by the lack of acceptable tools to make an accurate performance evaluation of overlapping networks with mathematical modeling, testbeds or simulation. Mathematical modeling typically introduces some assumptions like so-called protocol interference model [74], which unpredictably affects the obtained results. The most promising simulation platform is ns-3 [75]. However apart from the necessary 802.11ax functionality, capture effects need be implemented to correctly model collisions. Currently there are some activities in this direction [76]. As for a testbed, although some silicon manufactures have already announced 802.11ax chipsets, the first 802.11ax devices will not appear very soon. Numerous software defined radios, such as the

Wi-Fi Application Framework of National Instruments [77], have very simplified MAC operations to be used in the desired experiments.

Apart from that, even the approved mechanisms raise many open issues related to their operation, joint usage and optimization. First, it is not clear, how color collisions of neighboring BSSs may affect performance in dense and highly mobile scenarios. Second, how to use QTP (and whether it can be used) for avoiding collisions in overlapping networks. Third, whether and how rather heavy QTP signaling can be optimized. Fourth, how to select an adaptive sensitivity threshold based on the attenuation between the STAs in the same and neighboring BSSs. Finally, there is no clear algorithm of joint usage of BSS colors and Adaptive Sensitivity Threshold and Transmit Power. A possible approach to the latter problem is some adaptation of the MAPEL [78] algorithm, which (i) can take protocol limitations into account and (ii) has low complexity to dynamically reconfigure network on the flight.

## VI. POWER MANAGEMENT

### A. Legacy Power Management

In 802.11 networks, power management is based on alternating between two states: awake and doze. In the awake state, an STA can transmit and receive frames, while in the doze state, its radio is switched off. An active STA is always awake, while a PS STA alternates between these states.

Since the AP does not know the current state of a PS STA, it buffers all the frames (except for some real time ones) destined to this STA. To notify the PS STAs about the buffered packets, the AP includes a Traffic Indication Map (TIM) in beacons. A PS STA may sleep for a long time, however from time to time it wakes up to receive a beacon with a TIM element. It may also wake up earlier, if it has a frame to transmit. In this case before starting channel access, the STA shall wait for a frame reception (but not longer than the Probe Delay which is implementation dependent and may be comparable with the beacon period).

If the beacon indicates that no buffered packets are destined to the STA, it returns to the doze state. Otherwise, the STA sends a PS-Poll frame. As a response to the PS-Poll, the AP sends buffered frames.

Although the described concept is rather simple, it has been designed for rather low load and tailored for random access. In typical 802.11ax scenarios with dense networks, the high traffic load and the large number of power-limited smartphones and laptops, legacy power-saving mechanisms are inefficient. First, they may hang, i.e., the PS STAs may stay in the awake state for a long time, when traffic is delivered to other STAs. Second, the AP cannot deliver traffic without being polled. Third, PS-Polls allow only single-user transmission which is less efficient than the MU one. Finally, the overhead caused by PS-Polls is relatively huge.

The current standard also contains several methods which allow the scheduling in advance of service periods when the PS STAs can transmit or retrieve buffered packets from the AP. These methods are deeply connected with the HCCA functionality which is not implemented in out-of-the-shelf devices.

Apart from that, these methods are not suitable for OFDMA transmissions.

The key idea of the improvements introduced by TGax is that only the currently transmitting/receiving STAs need to be awake, while all the other STAs may switch off their radio. This can be done in the following way. First, the 802.11ax STAs may stay in the so-called microsleep mode, i.e., they can switch off their radio interface during some transmissions, when they cannot be involved in the frame exchange process. Second, TGax adapts the Target Wakeup Time (TWT), a lightweight mechanism designed in 802.11ah to schedule service periods, without using the HCCA functionality.

### B. Microsleep

The microsleep approach was introduced in 802.11ac. In 802.11ac, the PHY header contains the Partial AID which indicates the transmitter and the receiver(s) of a frame. Thus, all the other STAs can go to the doze state for the frame duration.

802.11ax extends this idea by allowing an STA to doze during UL transmissions or the TXOP of another STA in the same BSS. For that the HE-SIG-A field contains such information as the BSS Color, the remaining TXOP duration, the transmission direction (UL or DL), etc. Specifically, if a frame has the same color and it is either a UL frame or a DL MU frame not intended for the STA,<sup>8</sup> the STA can be sure that no frames will be transmitted to it till the end of TXOP and it can go to the doze state.

### C. TWT

In order to minimize the contention between STAs and to reduce power consumption, TGax adapted the TWT mechanism introduced in 802.11ah, a standard which adapts Wi-Fi for the Internet of Things scenarios and requirements. TWT allows an STA — called the TWT requesting STA — to negotiate with another STA or AP — called the TWT responding STA — periodically when the TWT requesting STA wakes up for some time (called TWT Service Period or TWT SP) and exchanges frames with the TWT responding STA. Thanks to this mechanism, the TWT requesting STA can doze always except during the TWT SP intervals. In particular, having established TWT SPs with the AP, the STA is not required to wake up even for beacons, which can significantly reduce energy consumption.

Note that the synchronization of TWT SPs between STAs is beyond the scope of the standard. Moreover, an established TWT SP itself does not forbid other STAs to access the channel. So, TWT does not provide contention-free channel access and the STAs transmit frames in TWT SPs using legacy channel access methods. To protect transmission from collisions, virtual carrier sense can be used.

In 802.11ah, the TWT operation is tightly connected with other 802.11ah enhancements such as with the Restricted Access Window channel access and the modified control frames, i.e., TACK, BAT, STACK, NDP Paging [23]. Since

<sup>8</sup>In case of DL MU transmission, the list of intended recipients is also in the packet preamble.

these enhancements are not supported by 802.11ax STAs, TGax has reimplemented and extended the concept of TWT.

In 802.11ax networks, TWT SPs can be either individually agreed or broadcast.

Individually agreed TWT SPs are negotiated between a pair of devices. During negotiations, they transmit to each other a special information element which contains TWT parameters and can be interpreted as request, suggestion, demand, alternation, acceptance, dictation, or rejection. Either the AP or the STA can teardown the TWT by transmitting a TWT Teardown frame.

The most important TWT parameters are the start of the first TWT SP and the Wake Interval, i.e., the interval between two consecutive TWT SPs. These two parameters determine the entire series of TWT SPs. Apart from them, the STAs negotiate on the following list of parameters.

- Minimum Wake Duration indicating the minimum value of TWT SP, after which the TWT requesting STA may return back to the doze state even if it has not received a frame. If needed a particular SP can be truncated even below this value, e.g., by transmitting a frame with the EOSP (End of Service Period) flag set up.
- Which types of frames should be transmitted within TWT SPs.
- Whether the transmission is to be done at the primary 20 MHz channel.
- Whether TWT SP shall be protected with a NAV protection mechanism, e.g., (MU-) RTS/CTS or CTS-to-self.
- Whether the TWT responding STA can be in the doze state outside the TWT SP.
- Whether the TWT requesting STA shall poll the TWT responding STA at the beginning of each TWT SP to indicate that it is awake, or the TWT responding STA sends frames to the TWT requesting STA without being polled.
- Whether the TWT SPs are Trigger-enabled. Trigger-enabled TWT SPs are favorable for UL MU operation and are only possible if TWT responding STA is the AP. Within such TWT SPs, the AP shall send at least one trigger frame allocating resources for the TWT requesting STA. Trigger-enabled TWT SPs are very fruitful for power-saving STAs. First, they enable all benefits of UL OFDMA transmission described in Section IV. Second, according to the standard, having waked up, a STA cannot immediately start a transmission without waiting for a frame which can set up its NAV or some timeout expires. Trigger frames allow the STA to shorten the waiting time.

The TWT requesting STA should not initiate a transmission of frames to the TWT responding STA inside the Trigger-enabled TWT SPs and outside any negotiated TWT SPs to prevent collisions with ongoing hidden transmissions.

The broadcast TWT SPs are similar to the individually agreed ones, except for small discrepancies. In particular, they are not negotiated but they are scheduled by the AP which distributes information about them in beacons. Those STAs which have received this information but have not established individual TWT SPs with the AP, should transmit information only within the announced broadcast TWT SPs. Consequently,

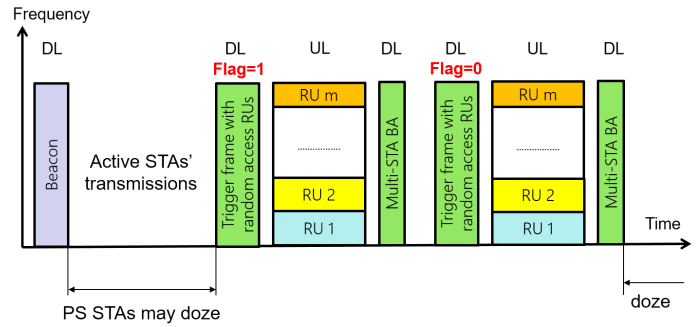

Fig. 13. An example of power save with Uplink OFDMA Random Access.

these STAs may doze always except for the TWT SPs and some beacons. The broadcast TWT SPs are very fruitful in conjunction with UL OFDMA Random Access. Specifically, the AP can schedule a series of Trigger frames. To notify the STAs about the first Trigger frame target transmission time in advance, the AP uses Broadcast TWT. To notify STAs about the following Trigger frames, the AP raises a special flag in every Trigger frame except for the last one. This flag means that another Trigger frame for random access follows the current UL transmission and DL ACKs, if any, see Fig. 13. Since a Trigger frame also contains the duration of the following transmission, the STAs may doze till the next Trigger frame allocating RUs for random access [79].

Awaking for beacons may be avoided in the following way. With the TWT signaling, the STA may negotiate with the AP on the interval during which the STA will not wake up to receive beacons.

#### D. Opportunistic Power Save

The Opportunistic Power Save (OPS) mechanism allows an AP to split a beacon interval into several subintervals — broadcast TWT SPs — and to provide, at the beginning of each subinterval, information on which STAs are going to be served in this subinterval. Based on this information, the non-AP STAs may opportunistically go to doze state until the next broadcast TWT SP.

This mechanism is based on the joint usage of TWT and the legacy TIM element. TIM is used in legacy power management mechanisms to indicate the set of STAs for which the AP has buffered data. In OPS, TIM is transmitted by the AP together with the broadcast TWT SP advertisement at the beginning of the TWT SP. In this case, TIM indicates a set of STAs that should be awake during the current TWT SP since the AP is going to transmit to them or trigger them for UL traffic. If a STA is not indicated in TIM, it can doze during the current TWT SP.

The idea of OPS is close to the TIM Segmentation [23] used in 802.11ah. However, in contrast to TIM Segmentation, OPS reduces time granularity.

#### E. Power Management Open Issues

The adopted power management mechanisms provide an excellent framework for increasing the lifetime of the



battery-powered devices. At the same time, their usage raises a number of questions.

Since Microsleep and Opportunistic Power Save allow a STA to switch off its radio, they should be deliberately used if the STA receives some QoS-sensitive traffic. When the STA is always awake, the AP can instantly modify its schedule decision once a packet destined for this STA arrives in the queue. In contrast, both Microsleep and Opportunistic Power Save make this impossible.

As for TWT, the most important issue is how to guarantee quick and contention-less channel access for a STA during the negotiated TWT SP in a dense environment. When the TWT SP begins, the channel may be busy with transmissions from the neighboring networks. Thus, in spite of obvious advantages of TWT, its real efficiency is a subject of investigation.

## VII. CONCLUSION

The 802.11ax amendment aims at challenging the *densification* of Wi-Fi deployments, by targeting a significant increase in the *throughput density*. In other words, it targets a greater *throughput-per-area* opposed to “just” the absolute throughput increase of past amendments via more advanced modulation and coding schemes. As comprehensively discussed in this tutorial, the new 802.11ax amendment, which has now reached a relatively stable version (version 3.0 at the time of writing), introduces significant novelties and departs from the past Wi-Fi versions significantly.

Arguably, the most disruptive innovation consists in the adoption of OFDMA for both directions (DL and UL). Loosely speaking, this change of channel access paradigm brings the next Wi-Fi generation somewhat closer to how cellular networks (in their fourth generation - LTE) operate. Still, as thoroughly discussed in the section dedicated to the new OFDMA operation, not only the technical details but also the deployment scenarios are very different and justify the novel (and nontrivial) mechanisms introduced by the 802.11ax amendment. Moreover, 802.11ax is not limited to OFDMA only. In contrast, it introduces several important innovations, including novel PHY functionalities, the extension of MU MIMO also to the UL direction, new flexible mechanisms mitigating interference from the overlapping networks, and the introduction of more aggressive power management approaches, all topics which have been addressed in detail in this tutorial.

In addition to introducing the reader to the various (and in some cases quite complex) technical aspects of 802.11ax, we tried whenever possible to give further hints on open issues interesting for industry and academia. Being a framework, the standard provides a list of new features, potentially fruitful for the efficiency of Wi-Fi networks, while the real gain from these features is determined by vendor-specific algorithms. One of the most crucial challenges is related to 11ax OFDMA scheduler that shall take into account 11ax peculiarities. Being implemented at the AP, the scheduler to a great extent determines the overall performance of the whole BSS. The second challenge is related to the optimal operation in dense environment. Dynamic adjustment of sensitivity threshold and transmit power is one of the most important and, at

the same time, arguable part of the standard, and its efficiency raises many questions both at TGax meetings and in academic papers. The third issue is related to energy saving, since it requires finding the balance between energy consumption and throughput. For example, both microsleep operation and TWT can increase collision probability in dense environment. Thus, there exist many optimization problems of the joint usage of various 11ax components.

In the tutorial, we have described in detail these and many other issues which should be resolved in order to implement forthcoming standard in a real equipment. Usually, the efficient solutions cannot be found without deep and thorough investigation made by researches from the top telecommunications companies and leading universities. We believe that our tutorial will attract further quantitative and/or foundational attention to 802.11ax challenges from the research community.

## REFERENCES

- [1] P. Serrano, P. Salvador, V. Mancuso, and Y. Grunenberger, “Experimenting with commodity 802.11 hardware: Overview and future directions,” *IEEE Commun. Surveys Tuts.*, vol. 17, no. 2, pp. 671–699, 2nd Quart., 2015.
- [2] R. Karmakar, S. Chattopadhyay, and S. Chakraborty, “Impact of IEEE 802.11n/ac PHY/MAC high throughput enhancements on transport and application protocols—A survey,” *IEEE Commun. Surveys Tuts.*, vol. 19, no. 4, pp. 2050–2091, 4th Quart., 2017.
- [3] J. Liu *et al.* (2013). *Discussions on 11ac PHY Efficiency*. [Online]. Available: <https://mentor.ieee.org/802.11/dcn/13/11-13-0544-03-0hew-discussions-on-11ac-phy-efficiency.ppt>
- [4] W. Tianyu, Z. Jiayin, Z. Lianbo, and M. Chixiang. (2013). *Performance Evaluation for 11ac*. [Online]. Available: <https://mentor.ieee.org/802.11/dcn/13/11-13-0576-03-0hew-performance-evaluation-for-11ac.pptx>
- [5] M. Kamel, W. Hamouda, and A. Youssef, “Ultra-dense networks: A survey,” *IEEE Commun. Surveys Tuts.*, vol. 18, no. 4, pp. 2522–2545, 4th Quart., 2016.
- [6] C. Lukaszewski *et al.* (2015). *BSS Color Field Size Measurements*. [Online]. Available: <https://mentor.ieee.org/802.11/dcn/15/11-15-1336-01-00ax-bss-color-field-size-measurements.pptx>
- [7] O. Aboul-Magd. (2014). *802.11 HEW SG Proposed PAR*. [Online]. Available: <https://mentor.ieee.org/802.11/dcn/14/11-14-0165-01-0hew-802-11-hew-sg-proposed-par.docx>
- [8] O. Aboul-Magd *et al.* (2014). *IEEE 802.11 HEW SG Proposed CSD*. [Online]. Available: <https://mentor.ieee.org/802.11/dcn/14/11-14-0169-01-0hew-ieee-802-11-hew-sg-proposed-csd.docx>
- [9] G. Smith. (2014). *DSC Implementation*. [Online]. Available: <https://mentor.ieee.org/802.11/dcn/14/11-14-0635-01-00ax-dsc-implementation.pptx>
- [10] D. Stanley. (2016). *802.11 January 2016 Closing Report*. [Online]. Available: <https://mentor.ieee.org/802.11/dcn/15/11-15-1529-01-0000-january-2016-wg-closing-report.pptx>
- [11] B. Bellalta, L. Bononi, R. Bruno, and A. Kassler, “Next generation IEEE 802.11 wireless local area networks: Current status, future directions and open challenges,” *Comput. Commun.*, vol. 75, pp. 1–25, Feb. 2016.
- [12] R. Stacey *et al.* (2015). *Specification Framework for TGax*. [Online]. Available: <https://mentor.ieee.org/802.11/dcn/15/11-15-0132-14-00ax-spec-framework.docx>
- [13] H. A. Omar *et al.*, “A survey on high efficiency wireless local area networks: Next generation WiFi,” *IEEE Commun. Surveys Tuts.*, vol. 18, no. 4, pp. 2315–2344, 4th Quart., 2016.
- [14] B. Bellalta, “IEEE 802.11ax: High-efficiency WLANs,” *IEEE Wireless Commun.*, vol. 23, no. 1, pp. 38–46, Feb. 2016.
- [15] D. J. Deng, K.-C. Chen, and R.-S. Cheng, “IEEE 802.11ax: Next generation wireless local area networks,” in *Proc. 10th Int. Conf. Heterogeneous Netw. Qual. Rel. Security Robustness (QShine)*, 2014, pp. 77–82.
- [16] E. Khorov, A. Kiryanov, and A. Lyakhov, “IEEE 802.11ax: How to build high efficiency WLANs,” in *Proc. IEEE En T, Moscow, Russia*, 2015, pp. 77–82.

- [17] E. Perahia and R. Stacey, *Next Generation Wireless LANs: 802.11n and 802.11ac*. Cambridge, U.K.: Cambridge Univ. Press, 2013.
- [18] M. S. Gast, *802.11ac, A Survival Guide: Wi-Fi at Gigabit and Beyond*. Beijing, China: O'Reilly Media, 2013.
- [19] *IEEE Standard for Information Technology—Telecommunications and Information Exchange Between Systems—Local and Metropolitan Area Networks—Specific Requirements—Part 11: Wireless LAN Medium Access Control (MAC) and Physical Layer (PHY) Specifications—Amendment 4: Enhancements for Very High Throughput for Operation in Bands Below 6 GHz*, IEEE Standard 802.11ac-2013, 2013.
- [20] O. Sharon and Y. Alpert, "Single user MAC level throughput comparison: IEEE 802.11ax vs. IEEE 802.11ac," *Wireless Sensor Netw.*, vol. 9, no. 5, pp. 166–177, 2017.
- [21] S. Kim *et al.* (2016). *11ax PAR Verification Through OFDMA*. [Online]. Available: <https://mentor.ieee.org/802.11/dcn/16/11-16-1363-00-00ax-11ax-par-verification-through-ofdma.ppt>
- [22] E. Khorov, A. Krasilov, A. Krotov, and A. Lyakhov, "Will MCCA revive wireless multi-hop networks?" *Comput. Commun.*, vol. 104, pp. 159–174, May 2017. [Online]. Available: <http://www.sciencedirect.com/science/article/pii/S0140366416304212>
- [23] A. Lyakhov, E. Khorov, A. Krotov, and A. Guschin, "A survey on IEEE 802.11ah: An enabling networking technology for smart cities," *Comput. Commun.*, vol. 58, pp. 53–69, Mar. 2015.
- [24] S. Venkateswaran *et al.* (2015). *Payload Symbol Size for 11ax*. [Online]. Available: <https://mentor.ieee.org/802.11/dcn/15/11-15-0099-03-00ax-payload-symbol-size-for-11ax.pptx>
- [25] E. Park *et al.* (2015). *1024 QAM Proposal*. [Online]. Available: <https://mentor.ieee.org/802.11/dcn/15/11-15-1070-03-00ax-1024-qam-proposal.ppt>
- [26] J. Liu *et al.* (2015). *Reliable Dual Sub-Carrier Modulations (DCM) for HE-SIG-B and Data*. [Online]. Available: <https://mentor.ieee.org/802.11/dcn/15/11-15-1068-01-00ax-reliable-transmission-schemes-for-he-sig-b-and-data.pptx>
- [27] *Draft Standard for Information Technology—Telecommunications and Information Exchange Between Systems—Local and Metropolitan Area Networks—Specific Requirements—Part 11: Wireless LAN Medium Access Control (MAC) and Physical Layer (PHY) Specifications—Amendment 6: Enhancements for High Efficiency WLAN. D3.0, Draft IEEE Standard P802.11*, 2018.
- [28] J. Zhang *et al.* (2015). *Preamble Structure for 11ax System*. [Online]. Available: <https://mentor.ieee.org/802.11/dcn/15/11-15-0101-01-00ax-preamble-structure-for-11ax-system.pptx>
- [29] H. Zhang *et al.* (2015). *802.11ax Preamble Design and Auto-Detection*. [Online]. Available: <https://mentor.ieee.org/802.11/dcn/15/11-15-0579-04-00ax-preamble-design-and-autodetection.pptx>
- [30] J. Zhang *et al.* (2015). *HE-SIGA Transmission for Range Extension*. [Online]. Available: <https://mentor.ieee.org/802.11/dcn/15/11-15-0826-03-00ax-he-sig-a-transmission-for-range-extension.pptx>
- [31] J. Liu *et al.* (2014). *Doppler Effect Evaluation for 11ax*. [Online]. Available: <https://mentor.ieee.org/802.11/dcn/14/11-14-1222-01-00ax-doppler-effect-evaluation-for-11ax.pptx>
- [32] R. Porat *et al.* (2016). *SIGA Fields and Bitwidths*. [Online]. Available: <https://mentor.ieee.org/802.11/dcn/15/11-15-1354-02-00ax-siga-fields-and-bitwidths.pptx>
- [33] J. Kim *et al.* (2015). *HE-SIG-B Structure*. [Online]. Available: <https://mentor.ieee.org/802.11/dcn/15/11-15-0821-02-00ax-he-sig-b-structure.pptx>
- [34] R. Porat *et al.* (2015). *SIG-B Encoding Structure Part II*. [Online]. Available: <https://mentor.ieee.org/802.11/dcn/15/11-15-1059-02-00ax-sig-b-encoding-structure-part-ii.pptx>
- [35] H. Zhang *et al.* (2015). *HE PHY Padding and Packet Extension*. [Online]. Available: <https://mentor.ieee.org/802.11/dcn/15/11-15-0810-01-00ax-he-phy-padding-and-packet-extension.pptx>
- [36] A. Blanksby *et al.* (2016). *Packet Extension Follow Up*. [Online]. Available: <https://mentor.ieee.org/802.11/dcn/16/11-16-0071-01-00ax-packet-extension-follow-up.pptx>
- [37] D. Xia, J. Hart, and Q. Fu, "Evaluation of the Minstrel rate adaptation algorithm in IEEE 802.11g WLANs," in *Proc. IEEE Int. Conf. Commun. (ICC)*, Budapest, Hungary, 2013, pp. 2223–2228.
- [38] Q. Qu, B. Li, M. Yang, and Z. Yan, "An OFDMA based concurrent multiuser MAC for upcoming IEEE 802.11ax," in *Proc. Wireless Commun. Netw. Conf. Workshops (WCNCW)*, New Orleans, LA, USA, 2015, pp. 136–141.
- [39] K. Taniguchi *et al.* (2016). *Allocation Sizes for BCC in OFDMA*. [Online]. Available: <https://mentor.ieee.org/802.11/dcn/16/11-16-0079-02-00ax-allocation-sizes-for-bcc-in-ofdma.pptx>
- [40] Z. Rong *et al.* (2015). *CP Indication for UL MU Transmission*. [Online]. Available: <https://mentor.ieee.org/802.11/dcn/15/11-15-0813-00-00ax-cp-indication-for-ul-mu-transmission.pptx>
- [41] S. Merlin *et al.* (2015). *Trigger Frame Format*. [Online]. Available: <https://mentor.ieee.org/802.11/dcn/15/11-15-0877-01-00ax-trigger-frame-format.pptx>
- [42] L. Chu *et al.* (2016). *MAC Padding in Trigger Frame*. [Online]. Available: <https://mentor.ieee.org/802.11/dcn/16/11-16-0067-01-00ax-mac-padding-in-trigger-frame.pptx>
- [43] A. Asterjadhi *et al.* (2015). *Buffer Status Report*. [Online]. Available: <https://mentor.ieee.org/802.11/dcn/15/11-15-1120-00-00ax-buffer-status-report.pptx>
- [44] C. Ghosh *et al.* (2015). *Fragmentation With MU Operation*. [Online]. Available: <https://mentor.ieee.org/802.11/dcn/15/11-15-1102-00-00ax-fragmentation-with-mu-operation.pptx>
- [45] C. Wang *et al.* (2015). *UL Multi-TIDs Aggregation*. [Online]. Available: <https://mentor.ieee.org/802.11/dcn/15/11-15-1065-01-00ax-11ax-uplink-multi-tid-aggregation.pptx>
- [46] A. Asterjadhi *et al.* (2015). *Fragmentation for MU Frames-Follow Up*. [Online]. Available: <https://mentor.ieee.org/802.11/dcn/16/11-16-0050-01-00ax-fragmentation-for-mu-frames-follow-up-on-acks.pptx>
- [47] P. Huang *et al.* (2015). *MU-RTS/CTS for DL MU*. [Online]. Available: <https://mentor.ieee.org/802.11/dcn/15/11-15-0867-01-00ax-mu-rts-cts-for-dl-mu.pptx>
- [48] Y. H. Kwon *et al.* (2016). *Protection Using MU RTS/CTS*. [Online]. Available: <https://mentor.ieee.org/802.11/dcn/16/11-16-0048-00-00ax-protection-using-mu-rts-cts.pptx>
- [49] S. Merlin *et al.* (2015). *Multi-STA Acknowledgment*. [Online]. Available: <https://mentor.ieee.org/802.11/dcn/15/11-15-0366-02-00ax-multi-sta-ack.pptx>
- [50] J. Kim *et al.* (2015). *Further Consideration on Multi-STA Block ACK*. [Online]. Available: <https://mentor.ieee.org/802.11/dcn/15/11-15-0626-01-00ax-further-consideration-for-multi-sta-block-ack-frame.pptx>
- [51] G. Li *et al.* (2015). *Multi-User Block ACK Request (MU-BAR)*. [Online]. Available: <https://mentor.ieee.org/802.11/dcn/15/11-15-1053-01-00ax-multiuser-block-ack-request-mu-bar.pptx>
- [52] Y. Seok *et al.* (2016). *Explicit Block ACK Request in DL MU PDU*. [Online]. Available: <https://mentor.ieee.org/802.11/dcn/16/11-16-0015-00-00ax-explicit-block-ack-request-in-dl-mu-ppdu.pptx>
- [53] C. Ghosh *et al.* (2015). *Random Access With Trigger Frames Using OFDMA*. [Online]. Available: <https://mentor.ieee.org/802.11/dcn/15/11-15-0875-01-00ax-random-access-with-trigger-frames-using-ofdma.pptx>
- [54] C. Ghosh *et al.* (2015). *UL OFDMA-Based Random Access Procedure*. [Online]. Available: <https://mentor.ieee.org/802.11/dcn/15/11-15-1105-00-00ax-ul-ofdma-based-random-access-procedure.pptx>
- [55] W. Ahn, Y. Y. Kim, and R. Y. Kim, "An energy efficient multiuser uplink transmission scheme in the next generation WLAN for Internet of Things," *Int. J. Distrib. Sensor Netw.*, vol. 12, no. 7, pp. 1–10, Jul. 2016.
- [56] I. Tinnirello and G. Bianchi, "Rethinking the IEEE 802.11e EDCA performance modeling methodology," *IEEE/ACM Trans. Netw.*, vol. 18, no. 2, pp. 540–553, Apr. 2010.
- [57] G. Bianchi, "Performance analysis of the IEEE 802.11 distributed coordination function," *IEEE J. Sel. Areas Commun.*, vol. 18, no. 3, pp. 535–547, Mar. 2000.
- [58] L. Cariou *et al.* (2016). *Rules for 2 EDCA Parameters*. [Online]. Available: <https://mentor.ieee.org/802.11/dcn/16/11-16-0998-03-00ax-rules-for-2-edca-parameters.pptx>
- [59] E. Khorov, V. Loginov, and A. Lyakhov, "Several EDCA parameter sets for improving channel access in IEEE 802.11ax networks," in *Proc. Int. Symp. Wireless Commun. Syst. (ISWCS)*, Poznań, Poland, 2016, pp. 419–423.
- [60] D. Bankov, A. Didenko, E. Khorov, and A. Lyakhov, "IEEE 802.11ax uplink scheduler to minimize delay: A classic problem with new constraints," in *Proc. IEEE Int. Symp. Pers. Indoor Mobile Radio Commun. (IEEE PIMRC)*, Montreal, QC, Canada, 2017, pp. 1–5.
- [61] P. Ameigeiras, J. Wigard, and P. Mogensen, "Performance of the M-LWDF scheduling algorithm for streaming services in HSDPA," in *Proc. IEEE 60th Veh. Technol. Conf.*, vol. 2, Los Angeles, CA, USA, 2004, pp. 999–1003.
- [62] J.-H. Rhee, J. M. Holtzman, and D. K. Kim, "Performance analysis of the adaptive EXP/PF channel scheduler in an AMC/TDM system," *IEEE Commun. Lett.*, vol. 8, no. 8, pp. 497–499, Aug. 2004.
- [63] A. Asterjadhi *et al.* (2015). *Identifiers in HE PPDUs for Power Saving*. [Online]. Available: <https://mentor.ieee.org/802.11/dcn/15/11-15-1122-00-00ax-identifiers-in-he-ppdus-for-power-saving.ppt>



- [64] Y. Inoue *et al.* (2015). *Number of BSS Color Bits*. [Online]. Available: <https://mentor.ieee.org/802.11/dcn/15/11-15-1075-01-00ax-number-of-bss-color-bits.pptx>
- [65] E. Khorov, A. Kiryanov, S. Schelstraete, and G. Wang. (2015). *Multiple NAVs for Spatial Reuse*. [Online]. Available: <https://mentor.ieee.org/802.11/dcn/15/11-15-1348-00-00ax-multiple-navs-for-spatial-reuse.pptx>
- [66] C. Thorpe and L. Murphy, "A survey of adaptive carrier sensing mechanisms for IEEE 802.11 wireless networks," *IEEE Commun. Surveys Tuts.*, vol. 16, no. 3, pp. 1266–1293, 3rd Quart., 2014.
- [67] M. S. Afaqui, E. Garcia-Villegas, E. Lopez-Aguilera, G. Smith, and D. Camps, "Evaluation of dynamic sensitivity control algorithm for IEEE 802.11ax," in *Proc. IEEE Wireless Commun. Netw. Conf. (WCNC)*, New Orleans, LA, USA, 2015, pp. 1060–1065.
- [68] M. S. Afaqui, E. Garcia-Villegas, and E. Lopez-Aguilera, "Dynamic sensitivity control algorithm leveraging adaptive RTS/CTS for IEEE 802.11ax," in *Proc. IEEE Wireless Commun. Netw. Conf.*, Doha, Qatar, 2016, pp. 1–6.
- [69] E. Khorov *et al.*, "Joint usage of dynamic sensitivity control and time division multiple access in dense 802.11ax networks," in *Proc. 9th Int. Workshop Multiple Access Commun. (MACOM)*, Aalborg, Denmark, 2016, pp. 1–6.
- [70] G. R. Hiertz *et al.* (2015). *Multiple BSSID Element*. [Online]. Available: <https://mentor.ieee.org/802.11/dcn/15/11-15-1014-00-00ax-multiple-bssid-element.pptx>
- [71] G. Ko *et al.* (2016). *BSS Color Settings for a Multiple BSSID*. [Online]. Available: <https://mentor.ieee.org/802.11/dcn/16/11-16-0042-02-00ax-bss-color-settings-for-a-multiple-bssid-set.pptx>
- [72] F. Cao *et al.*, "User association for load balancing with uneven user distribution in IEEE 802.11ax networks," in *Proc. 13th IEEE Annu. Consum. Commun. Netw. Conf. (CCNC)*, Las Vegas, NV, USA, 2016, pp. 487–490.
- [73] D. Stanley *et al.* (2016). *Report: 802.11ax Dominance Complaint*. [Online]. Available: <https://mentor.ieee.org/802.11/dcn/16/11-16-1519-00-0000-report-from-11ax-dominance-investigation.docx>
- [74] A. Krasilov, "Physical model based interference classification and analysis," in *Proc. MACOM*, 2010, pp. 1–12.
- [75] *The NS-3 Network Simulator*. Accessed: Feb. 1, 2018. [Online]. Available: <http://www.nsnam.org/>
- [76] *Bug 2368—Code Review: WiFi Frame Capture Model*. Accessed: Feb. 1, 2018. [Online]. Available: [https://www.nsnam.org/bugzilla/show\\_bug.cgi?id=2368](https://www.nsnam.org/bugzilla/show_bug.cgi?id=2368)
- [77] *LabVIEW Communications 802.11 Application Framework 1.1 White Paper*, Nat. Instrum., Austin, TX, USA, 2016. [Online]. Available: <http://www.ni.com/product-documentation/52533/en/>
- [78] L. P. Qian and Y. J. Zhang, "S-MAPEL: Monotonic optimization for non-convex joint power control and scheduling problems," *IEEE Trans. Wireless Commun.*, vol. 9, no. 5, pp. 1708–1719, May 2010.
- [79] C. Ghosh *et al.* (2015). *Power Save With Random Access*. [Online]. Available: <https://mentor.ieee.org/802.11/dcn/15/11-15-1107-00-00ax-power-save-with-random-access.pptx>



**Evgeny Khorov** is the Head of the Wireless Networks Lab, Institute for Information Transmission Problems, Russian Academy of Sciences. In 2015, he was a Visiting Research Fellow with King's College London. For breakthrough results of the joint project, in 2015 and 2017 Huawei RRC awarded him as the Best Cooperation Project Leader. Being a voting member of IEEE 802.11, he has contributed to 802.11ax standard with many proposals. He has authored over 70 papers. His main research interests are

related to 5G and beyond wireless systems, next generation Wi-Fi, protocol design and cross-layer optimization. He has led dozens of national and international projects sponsored by academia funds and industry. He was a recipient of the Moscow Prize for Young Scientists in 2013 and Russian Government Award in Science and Technology for Young Scientists, the Best Paper Award from IEEE ISWCS in 2012, and the Best Cited Review Paper Award from Elsevier Computer Communications in 2018. He gives keynotes and tutorials and participates in panels at large conferences, including IEEE Globecom in 2017, IEEE PIMRC in 2017, IEEE ICC in 2016, ISWCS in 2014, and NEW2AN in 2018. He chairs TPC of the IEEE Globecom 2018 CA5GS Workshop and IEEE BlackSeaCom 2019. He also serves as an Editor for *Ad Hoc Networks*.



**Anton Kiryanov** received the B.S. and M.S. degrees from the Moscow Institute of Physics and Technology (State University) in 2011 and 2013, respectively, and the Ph.D. degree in telecommunications from the Institute for Information Transmission Problems, Russian Academy of Sciences (IITP RAS) in 2017. His major research interests are connected with Wi-Fi and cellular networks with the focus on channel access methods and radio resource management for quality of service provisioning. He is currently a Senior Researcher with Network Protocols Research Lab, IITP RAS. From 2014 to 2015, he was an IEEE 802.11 voting member and took part in the development of upcoming IEEE 802.11ax amendment by contributing a number of proposals which were accepted by task group AX. He has authored over 15 papers published in international journals and conference proceedings. He was a recipient of the Best Paper Award at the International Symposium on Wireless Communication Systems in 2012. He participates in national and international projects and makes research within the framework of joint research projects with the leading telecommunication companies.



**Andrey Lyakhov** is a Full Professor, the Deputy Director, and the Head of the Network Protocols Research Laboratory, Institute for Information Transmission Problems, Russian Academy of Sciences. His main research interests are related to design and analysis of wireless network protocols, wireless network performance evaluation methods, and stochastic modeling of wireless networks based on random multiple access. He has over 20 years of experience in Wi-Fi networks design and performance evaluation. He has authored three monographs, about 100 papers cited in Scopus, and has ten patents. He has authored several courses on analytical modeling of network protocols and he is a supervisor for master and Ph.D. students. He was a member of technical and program committees of large IT conferences (ICC, MACOM, MobiHoc, Networking, and MASS). He was a recipient of number of International and Russian awards. He led a number of joint research projects with top telecommunication companies and collaborative projects (e.g., FP7 ICT collaborative project FLAVIA "Flexible Architecture for Virtualizable wireless future Internet Access," from 2010 to 2012).



**Giuseppe Bianchi** has been a Full Professor of networking at the School of Engineering, University of Roma Tor Vergata since 2007. His research activity is documented in over 200 peer-reviewed international journal and conference papers, having received over 15 000 Google Scholar citations. He has carried out pioneering research work on WLAN performance modeling, and is currently interested in wireless systems, network programmability, privacy and security, and performance evaluation. He has chaired over ten international conferences (e.g., IEEE Infocom, ACM CoNext, ITC, WoWMoM, and LANMAN), and has coordinated several large scale European Projects (FP6-DISCREET, FP7-FLAVIA, FP7-PRISM, FP7-DEMONS, H2020-BEBA, and H2020-SCISSOR). He has been (or still is) an Editor for top journals in his field, including the IEEE/ACM TRANSACTIONS ON NETWORKING, the IEEE TRANSACTIONS ON WIRELESS COMMUNICATIONS, and the IEEE TRANSACTIONS ON NETWORK AND SERVICE MANAGEMENT.