

Design and Development of a Wristband for Continuous Vital Signs Monitoring of COVID-19 Patients

Seyedfakhreddin Nabavi, *Member, IEEE*, and Sharmistha Bhadra, *Member, IEEE*

Abstract— The novel coronavirus disease (COVID-19), as a pandemic, has intensely impacted the global healthcare systems. Remote health monitoring of positive COVID-19 patients isolating at home has been identified as a practical approach to minimize the mortality rate. This work proposes a cost-effective and ease-to-use wristband with the capability of continuous real-time monitoring of heart rate (HR), respiration rate (RR), and blood oxygen saturation (SpO₂), temperature and accelerometry. The proposed wristband comprises three different sensing elements, namely, PPG sensor, temperature sensor, and accelerometer. The sensors' output signals are transmitted via Bluetooth. Process of the PPG signals measured from the wrist anatomical position provides essential information regarding HR, RR, and SpO₂. The deployed temperature sensor and accelerometer, measure the wearers' body temperature and physical activities. Experimental results obtained from a group of subjects demonstrate that the wristband can monitor HR, RR, SpO₂, and body temperature with the Mean Absolute Errors (MAEs) of 2.75 bpm, 1.25 breaths/min, 0.64%, and 0.22 C°, respectively. Such a small variation confirms that the wristband can be potentially deployed in the public health network to determine and track patients infected by COVID-19.

I. INTRODUCTION

The ongoing coronavirus disease (COVID-19) pandemic, causing more than 2 million deaths so far has predominately affected all aspects of modern life, such as the world job market, food supply network, and health care systems [1]. Particularly, healthcare systems have been faced with numerous challenges by the hospitalization surge of COVID-19 patients. Most of those who test positive are sent back home and asked to self-isolate. While most patients have few negative reactions to COVID-19 infections, between 2%-8% have severe responses that lead to respiratory distress, organ failure, and death. Currently, public health workers track the progression of the illness of the COVID-19 patients sent home by calling them 1-by-1 and asking questions on symptoms. Tracking the cases more widely is an indispensable approach to minimize the mortality rate. However, as the number of people being tested positive for COVID-19 is increasing, the current 1-by-1 call approach becomes unsustainable. Instead, patients can be followed by remote monitoring of their vital signs, which provides more information about health than the regular symptom-based questions.

It is widely discussed that COVID-19 influences on specific health metrics, like body temperature, heart rate (HR), respiration rate (RR), and blood oxygen saturation (SpO₂) [2].

* The research was supported by Natural Sciences and Research Council of Canada, and MITACS.

A recent study done by Ding *et al.* [3] shows that monitoring such health indicators in-home or ambulatory environments can effectively and efficiently identify early symptoms of COVID-19, which will ultimately reduce the spread level of virus [4]. In this context, using wearable technology is an advantageous method to extend continuous health monitoring beyond hospitals.

Pulse oximetry, as a non-invasive measurement technique to screen multiple cardiorespiratory parameters, i.e., HR, RR, and SpO₂, has been widely used in different levels of clinical setting, like emergency departments, and intensive care units [5]. This method relies on the transmission of light through cutaneous tissue at two standalone wavelengths to determine blood volume changes. The usage of pulse oximetry-based technique can be readily deployed for portable and wearable monitoring systems [6]. Hence, in the literature, wearable pulse oximetry devices' capability to accurately measure various cardiac activities is extensively discussed [7][8]. It cannot be ignored that the wearable pulse oximetry-based technique is not confined to only research activity, as numerous commercially available devices, such as Apple Watch [9], and Fitbit [10], use pulse oximetry. These devices are mostly incapable of simultaneous real-time screening COVID-19 vital signs (i.e., HR, RR, SpO₂, and body temperature). For instance, Oura [11], a sensing platform in the form of a wearable ring, cannot measure SpO₂ level. Consequently, its clinical usage for patients suffer from COVID-19 remains considerably low. On the other hand, the current commercial wearable monitoring devices are relatively costly, thus, they can be rarely used as an accessible approach to the worldwide population.

In an earlier attempt to battle against the COVID-19 pandemic, Stojanovic *et al.* [12] proposed a wearable headset

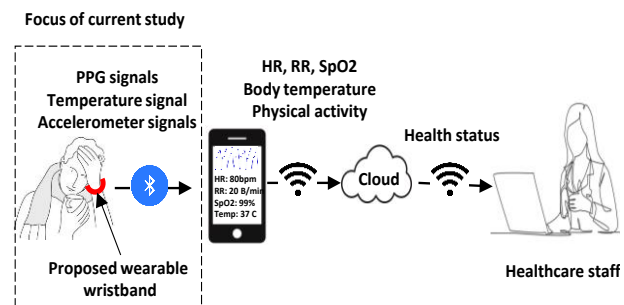

Fig. 1. Conceptual drawing of the proposed wearable wristband for continuous vital signs monitoring in COVID-19 patients.

The authors are with the Department of Electrical and Computer Engineering, McGill University, Montreal, QC H3A-0E9, Canada (corresponding author S. Nabavi; e-mail: seyed.nabavi@mcgill.ca).

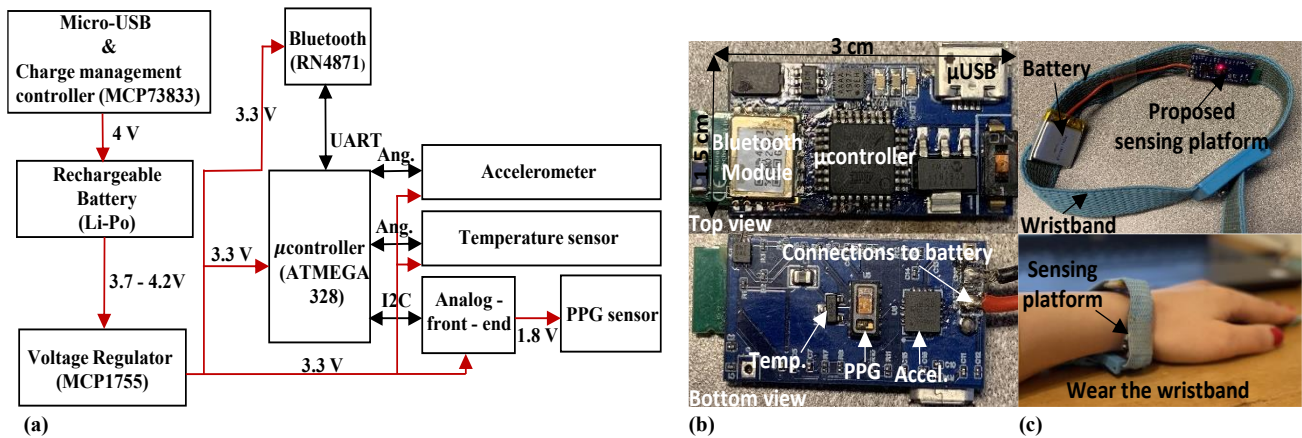

Fig. 2. (a) Overall functional block diagram of the proposed sensing platform, and (b) photos of the implemented system on the PCB. (c) Demonstration of a wristband integrated with the proposed sensing platform, and wore it by the subject.

to detect and track most COVID-19 symptoms. In this method, the process of audio signals recorded by the embedded microphone in the headset determines RR, in addition to the number and duration of cough. Furthermore, the assembled temperature and photoplethysmography (PPG) sensors in one of the earphones provide crucial information regarding body temperature and HR, respectively. Although such a tracking system is low-cost and can monitor different vital signs, its comfortability level for a long-time monitoring aims is apparently low, since wearing the headsets long-time every day—specifically during sleep—is not applicable for the end-users, i.e., patients.

In this study, we are motivated to propose a low-cost and easy-to-use wristband for continuous vital signs screening to overcome the current existing shortages. In Fig. 1, the conceptual drawing of the proposed wristband to widely monitor health status of the patients is illustrated. The proposed sensing platform, which is in the form of a wearable wristband, can be potentially used for determining and tracking symptoms in COVID-19 patients. In this regard, three sensing elements, namely, PPG sensor, temperature sensor, and accelerometer are employed to measure cardiac activities, body temperature, and physical activities, respectively. Upon measuring these physiological signals by the wristband, the recorded data are transmitted to a handheld computer (PC) or phone via Bluetooth for extracting multiple cardiorespiratory parameters, i.e., HR, RR, and SpO₂.

II. HARDWARE IMPLEMENTATION

In Fig. 2, the functional block diagram of the proposed wristband is depicted. As shown in this figure, the entire sensing platform is powered up by a 150 mAh recharger battery (Li-Po). Its output voltage is varied between 3.7 V and 4.2 V depending on the battery's charge level. In order to readily charge the battery and enhance the portability of the sensing platform, a micro-USB associated with a charge management controller manufactured by Microchip is employed. A voltage regulator manufactured by Microchip (MCP1755) is utilized to provide a 3.3 V constant voltage for the other operational units.

A Microcontroller manufactured by Microchip (ATMEGA 328) controls the functionality of the proposed sensing platform. In this regard, the microcontroller continuous real-

time reads the sensors' output signals (i.e., PPG sensor, temperature sensor, and accelerometer) through I2C and analog port protocols. Thereafter, the recorded data are transmitted to a nearby PC/Phone via a Bluetooth module manufactured by Microchip (RN4871).

The proposed monitoring platform comprises three different sensors, namely, PPG sensor, temperature sensor, and accelerometer. The embedded PPG sensor, which is manufactured by Maxim Integrated (MAX30102), operates at two distinct wavelengths, i.e., Red (660 nm) and IR (880 nm). The sensor has several integrated units as follows: LED driving system, current analog to digital converter (ADC), data FIFO, and I2C digital output interface. The ADC converts the photodiode current of the PPG sensor to a digital signal. Whereas, the digital signal is stored in a 32 deep FIFO. The I2C interface reads the FIFO data. SCL and SDA pins of the microcontroller can read the PPG signal. The PPG sensor input voltage is not same with the operating voltage of other units, then a stepdown converter manufactured by Maxim Integrated (MAX1921) is used to convert the 3.3 V to 1.8 V. Due to logic levels deference between PPG sensor and microcontroller a level shifter manufactured by Maxim Integrated (MAX12595) is utilized. Complementary information regarding this sensor can be found here [13].

An analog temperature sensor manufactured by Microchip (MCP9700) is deployed to measure temperature. This sensor has an integrated active thermistor circuit. Hence, the temperature gradient reflects as the voltage changes. A 3-axis analog accelerometer manufactured by Analog Devices (ADXL 326) is suited in a position close to the PPG and temperature sensors. This is a capacitance accelerometer, whereas mechanical motion after demodulating and processing will be presented as an analog signal.

In Fig. 2 (b), photos of the prototyped sensing platform are illustrated. With reference to this figure, a double-sided rigid printed circuit (PCB) with a footprint of 3 cm × 1.5 cm houses the sensing platform's components. As a result, it can be easily integrated into a wristband and comfortably worn, as shown in Fig. 2 (c). As shown in this figure, the proposed sensing platform is in contact with the radial artery of the wearer. The average battery lifetime is about 11 hours on a single charge. It is worth mentioning that the cost of the proposed sensing platform will be considerably low at scaled production. In

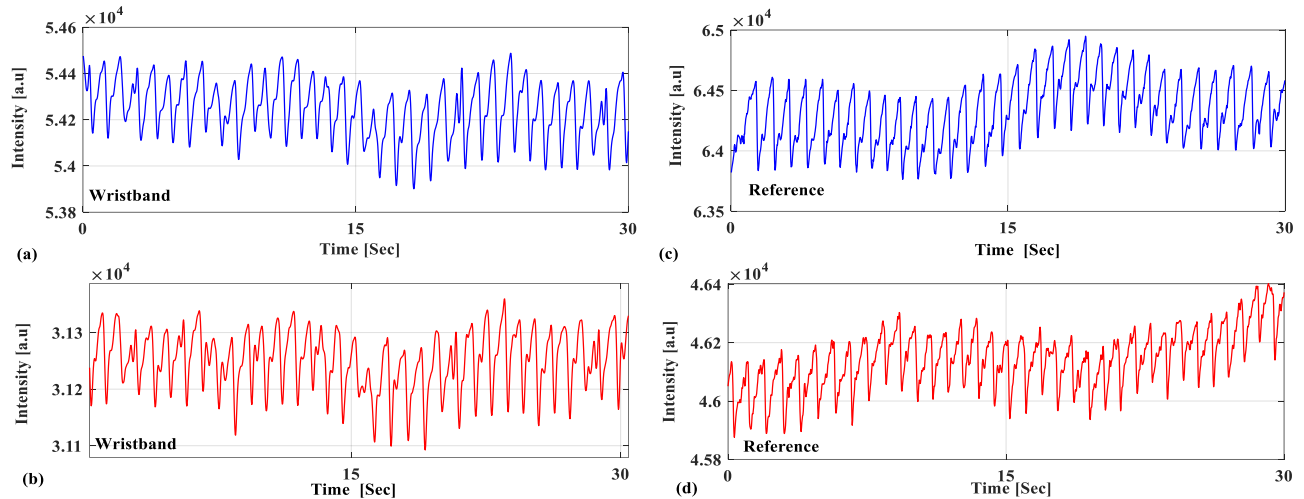

Fig. 4. (a) Measured PPG signals by the proposed wristband (left side) and reference measurement (right side) at (a & c) IR and (b & d) Red wavelengths, respectively.

Table I, the estimated power consumption and cost breakdowns for each employed component are listed.

TABLE I. ESTIMATED POWER CONSUMPTION AND COST BREAKDOWNS OF THE PROPOSED MONITORING PLATFORM.

Component	Power [mW]	Cost [Cad \$]
PPG sensor and its analog front-end circuit	4.95	21.3
Temperature sensor	0.1	0.37
Accelerometer	0.35	9.4
Bluetooth module	7.3	10.87
Microcontroller	0.54	3.5
Regulator	0.22	1.02
Battery	-	1.5
PCB manufacturing	-	1
Total	~13.46	48.59

III. CARDIORESPIRATORY PARAMETERS ESTIMATION

In this study, the proposed wearable wristband's measured physiological signals are real-time transmitted to a nearby PC via Bluetooth for vital signs monitoring. The estimations of cardiorespiratory parameters were done off-site with no digital filtering to quality enhancement of the measured signals.

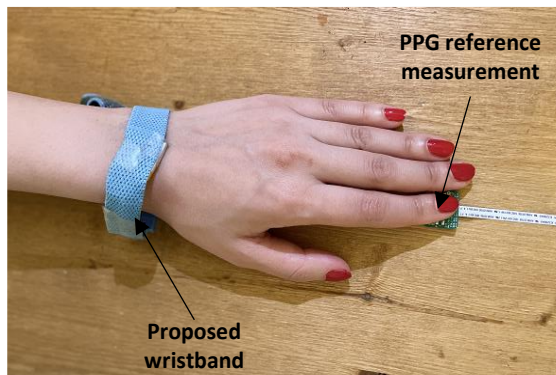

Fig. 3. Experimental setup utilized to characterize the proposed wristband.

HR values were estimated from the measured PPG signals at IR wavelength. In this regard, peaks of the PPG signals in the time domain identified, thereafter the time difference between two consecutive peaks considered as HR values. Respiratory signals are obtained from process the peak-peak amplitude of PPG signal at IR wavelength in the time domain. SpO₂ levels, which is the percentage of oxygenated hemoglobin blood, were computed based on pulsatile and non-pulsatile components of the PPG signals at both Red and IR wavelengths. Further information regarding these employed techniques to estimate different cardiorespiratory parameters from the outputs of a single PPG sensor can be found in our previous work [14].

IV. EXPERIMENTAL RESULTS AND DISCUSSION

In this study, the quality of the measured PPG signals and accuracy of estimated cardiorespiratory parameters by our devised sensing platform were investigated in comparison to a reference measurement. The reference measurement is the signals received from an identical PPG sensor placed on the conventional anatomical location, i.e., the left index fingertip. It is worth mentioning that the accuracy of the reference measurement is comparable with the commercial FDA/ISO standards medical-grade devices [15]. Our utilized experimental setup is illustrated in Fig. 3, and it is in accordance with the Deceleration of Helsinki and was approved by Institutional Review Board of McGill University (study number: A04-M21-19B, approval date: 04/17/2019).

In Fig. 4, simultaneously measured PPG signals by the proposed wristband and reference measurement at both wavelengths, i.e., Red and IR, are shown for 30 seconds. It can be observed that the PPG signals wirelessly received from the wrist position by our proposed sensing platform is in high correlation with their counterparts, i.e., ones obtained from the fingertip through wire connection. Such a high correlation is not limited to one wavelength. The captured PPG signals at both wavelengths are in good agreement with their corresponding reference signals. On the other side, the intensities of PPG signals captured from the wrist by our proposed wristband have a slightly lower level than those

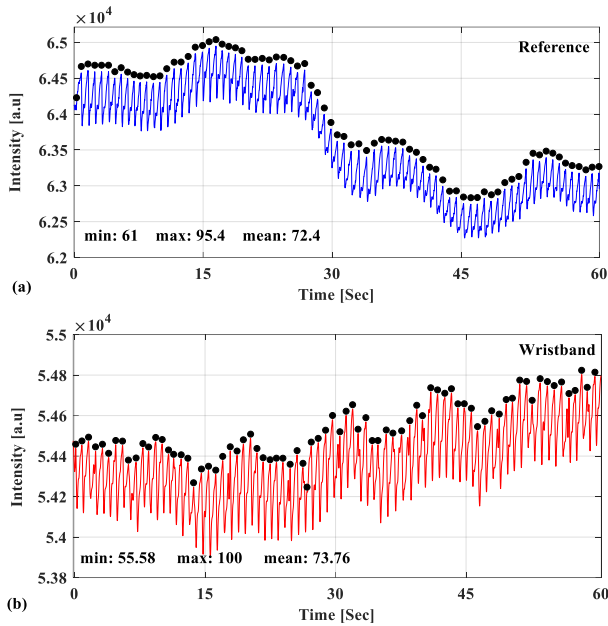

Fig. 5. Estimated HR values with demonstration of the detected peaks from the measured PPG signals by (a) reference measurement, and (b) proposed wristband, respectively.

obtained from the fingertip. This variation is mainly due to different peripheral tissues at the wrist and fingertip. Advantageously, estimating cardiorespiratory is dependent on the ratio of PPG signals rather than their absolute values. Furthermore, the unique features of PPG signals, such as peaks, periodically, and baseline, are clearly distinguishable in the signals captured by the proposed wristband. This implies that the PPG signals measured by our proposed wristband from the wrist anatomical position can be used to estimate multiple cardiorespiratory parameters accurately due to their remarkable information.

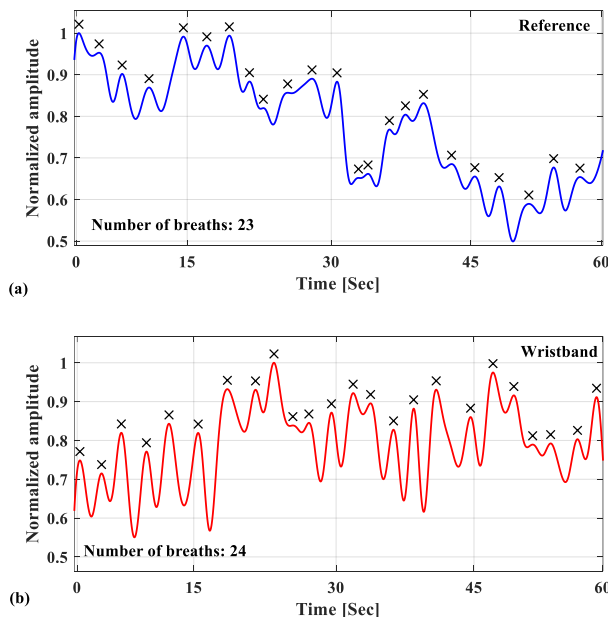

Fig. 6. Estimated respiratory signals with demonstration of the detected peaks as breathe events from the measured PPG signals by (a) reference measurement, and (b) proposed wristband, respectively.

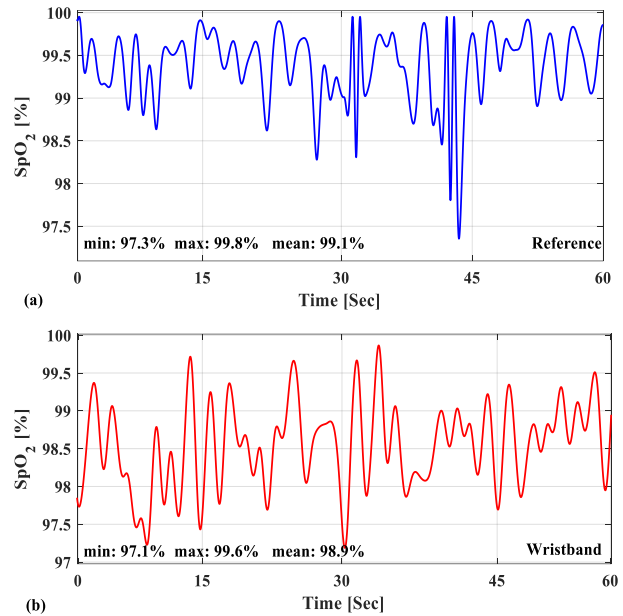

Fig. 7. Estimated SpO₂ levels from the measured PPG signals by (a) reference measurement, and (b) proposed wristband, respectively.

To demonstrate the ability to accurately estimate the multiple cardiorespiratory parameters from the wristband, PPG signals of the subject while he/she was in the sitting position were measured by the wristband and reference one for 60 seconds. Thereafter, based on the cardiorespiratory parameter estimation techniques described in Section III, HR, RR, and SpO₂ level were calculated and illustrated in Figs. 5, 6, and 7, respectively.

In Fig. 5, the estimated HR values from the wristband and reference measurement are shown. According to the reference measurement, HR of the subject is varied between 61 bpm and 95.4 bpm, with a mean value of 72.4 bpm. The estimated HR values from the PPG signal captured by the proposed wristband shows that during the measurement the subject's HR were within a range of 55.58 - 100 bpm, with a mean value of 73.76 bpm. The mean difference between HR values is only 1.4 bpm. This indicates that our proposed wristband can estimate HR relatively close to the reference measurement.

The estimated respiratory signals from the PPG signals captured by the proposed wristband and reference measurement are illustrated in Fig. 6. With reference to this figure, the total breaths of 23 were detected based on the reference signal, while the estimated RR from the wristband is 24 breaths/min. Such a small discrepancy (i.e., +1 breaths/min) between the estimated RR from the reference measurement and wristband accredits that the PPG signals measured from the wrist position by our proposed sensing platform can be deployed to compute RR, and ultimately determine any distress in respiratory system.

In Fig. 7, the estimated SpO₂ levels are displayed. According to the reference measurement signal, the subject's SpO₂ level during measurement (i.e., 60 seconds) varied in a range of 97.3% - 99.8%, with a mean value of 99.1%. The estimated SpO₂ from the PPG signals recorded by our proposed wristband exhibits that SpO₂ level was changed between 97.1% and 99.6%, with a mean value of 98.9%. It

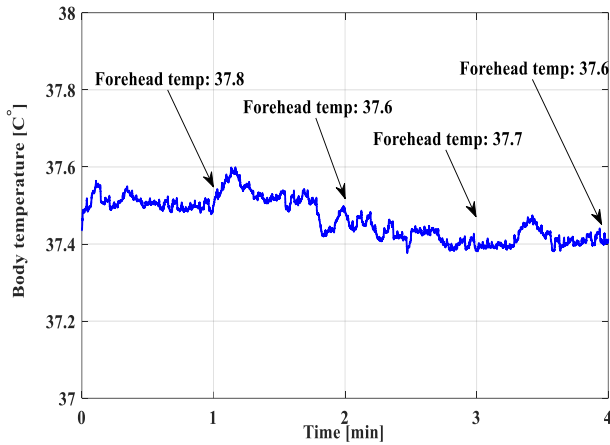

Fig. 8. Continuously recorded body temperature by the proposed wristband and reported forehead temperature every minute measured by the commercial non-contact thermometer.

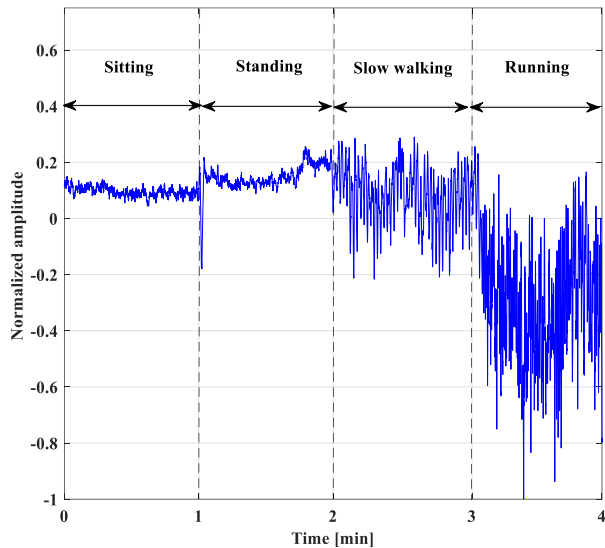

Fig. 9. Accelerometer output signal for four human physical activities, namely, sitting, standing, slow walking, and running, respectively.

can be concluded that process of the PPG signals measured by our proposed wristband can provide relatively accurate information regarding the SpO₂ level when compared to the reference measurement.

Body temperature elevation in the patients infected with COVID-19 is an acute symptom that can be used for predicting the progression of the disease to a severe stage [16]. In Fig. 8,

body temperature of the subject measured by the wristband for a duration of 4 minutes is reported. To validate the accuracy of measured data, the subject's forehead temperature was monitored every minute using a non-contact inferred thermometer (manufactured by Mastercraft). It can be seen that body temperature measured by our proposed wearable wristband is relatively comparable with one recorded by the commercial thermometer. Indeed, screening temperature 4 times at different instants confirms the wristband's stability and reliability for accurate body temperature monitoring.

In the literature, the competence of inertial motion sensors, e.g., accelerometer, to track human physical activities has been widely discussed [17][18]. To show that the proposed wristband is able to identify different motions, the subject was asked to carry out four different activities with a time interval of 1 minute as follows: sitting, standing, slow walking, and running. As shown in Fig. 9, each activity changes the level and pattern of the accelerometer signal considerably. For this reason, regardless of classifier tools, the subject's activities will be readily recognized. Such information can also be potentially used to determine the impact of the COVID-19 on patients' daily activities.

To this end, it is shown that the proposed wearable wristband is capable to continuously monitor cardiorespiratory parameters, i.e., HR, RR, and SpO₂, beside body temperature and physical activities. In order to verify the reliability of our system, a group of 4 subjects was asked to wear the wristband and sit on a chair with no motion for 1 minute. In Table II, the measured vital signs by our proposed wristband and reference measurements (i.e., PPG sensor placed on the fingertip and non-contact thermometer) are summarized. As shown in the last row of this Table, Mean Absolute Error (MAE) values computed for the measured HR, RR, SpO₂, and body temperature are 2.75 bpm, 1.25 breaths/min, 0.64%, and 0.22 C°, respectively. Such a small variation in the MAEs of the measured vital signs indicates that the performance of the proposed wristband is not dependent on a specific subject, while almost a similar level of variation can be seen for all the subjects.

V. CONCLUSION AND FUTURE WORK

This study proposes a cost-effective and ease-to-use wearable wristband to monitor vital signs of COVID-19 patients continuously. The wristband integrated 3 cm × 1.5 cm sensing platform, is comprised of three sensing elements: dual-channel PPG sensor, temperature sensor, and accelerometer. In this regard, process of the PPG signals measured from the wrist anatomical position provides essential information regarding HR, RR, and SpO₂. The

TABLE II. SUMMARY OF THE MEASURED VITAL SIGNS BY THE PROPOSED WRISTBAND AND REFERENCE MEASUREMENTS FOR FOUR SUBJECTS.

Subject ID	HR [bpm]			RR [breaths/min]			SpO ₂ [%]			Temperature [C°]		
	Wristband	Ref.	Error	Wristband	Ref.	Error	Wristband	Ref.	Error	Wristband	Ref.	Error
1	83	79	+4	20	19	+1	98.85	99.5	-0.65	37.02	37.1	-0.08
2	82	79	+3	18	19	-1	99.5	99.6	-0.1	37.33	37.6	-0.27
3	72	71	+1	21	23	-2	98.6	99.9	-1.3	37.54	37.8	-0.26
4	75	72	+3	21	20	+1	99.2	99.7	-0.5	37.45	37.7	-0.25
MAE	2.75			1.25			0.64			0.22		

embedded temperature sensor and accelerometer monitor the wearers' body temperature and physical activities. By examining a group of subjects, it is shown that the wristband can monitor HR, RR, SpO₂, and body temperature with the MAEs of 2.75 bpm, 1.25 breaths/min, 0.64%, and 0.22 C°, respectively. Such a small variation in the measured MAEs demonstrates that the wearable wristband has the considerably reliable and repeatable performance. As a result, it can be potentially deployed in the public health network to determine and track patients suffer from COVID-19.

As known, the PPG signals can be affected by any voluntary or involuntary subject motions. The authors previously proposed a robust sensor fusion technique (by using of PPG sensor and accelerometer data) to remove motion artifacts from the recorded PPG signals [19]. In this regard, as future work, the accelerometer output signals measured by the wristband will be used to eliminate the motion artifacts in the recorded PPG signals.

REFERENCES

- [1] M. Nicola *et al.*, "The socio-economic implications of the coronavirus and COVID-19 pandemic: a review," *Int. J. Surg.*, 2020.
- [2] G. Quer *et al.*, "Wearable sensor data and self-reported symptoms for COVID-19 detection," *Nat. Med.*, pp. 1–5, 2020.
- [3] X.-R. Ding *et al.*, "Wearable sensing and telehealth technology with potential applications in the coronavirus pandemic," *IEEE Rev. Biomed. Eng.*, 2020.
- [4] M. M. Islam, S. Mahmud, L. J. Muhammad, M. R. Islam, S. Nooruddin, and S. I. Ayon, "Wearable technology to assist the patients infected with novel coronavirus (COVID-19)," *SN Comput. Sci.*, vol. 1, no. 6, pp. 1–9, 2020.
- [5] A. M. Luks and E. R. Swenson, "Pulse oximetry for monitoring patients with COVID-19 at home. potential pitfalls and practical guidance," *Ann. Am. Thorac. Soc.*, vol. 17, no. 9, pp. 1040–1046, 2020.
- [6] S. Nabavi, S. Debbarma, and S. Bhadra, "A Smart Mandibular Advancement Device for Intraoral Cardiorespiratory Monitoring," in *Proc. 42nd Annual International Conference of the IEEE Engineering in Medicine & Biology Society (EMBC)*, 2020, pp. 4079–4084.
- [7] P. J. Chacon *et al.*, "A wearable pulse oximeter with wireless communication and motion artifact tailoring for continuous use," *IEEE Trans. Biomed. Eng.*, vol. 66, no. 6, pp. 1505–1513, 2018.
- [8] H. Lee, S. Park, C. Lim, and C. Kim, "A 100-nW 9.1-ENOB 20-kS/s SAR ADC for portable pulse oximeter," *IEEE Trans. Circuits Syst. II Express Briefs*, vol. 62, no. 4, pp. 357–361, 2015.
- [9] "Apple Watch." [Online]. Available: <https://www.apple.com/ca/watch/>. [Accessed: 02-Feb-2021].
- [10] "Fitbit." [Online]. Available: <https://www.fitbit.com/global/en-ca/home>. [Accessed: 10-Aug-2020].
- [11] "Oura Ring." [Online]. Available: <https://ouraring.com/>. [Accessed: 08-Oct-2020].
- [12] R. Stojanović, A. Škraba, and B. Lutovac, "A headset like wearable device to track covid-19 symptoms," in *2020 9th Mediterranean Conference on Embedded Computing (MECO)*, 2020, pp. 1–4.
- [13] "Maxim Integrated." [Online]. Available: <https://www.maximintegrated.com/en/design/reference-design-center/system-board/6300.html>.
- [14] S. Nabavi and S. Bhadra, "A Robust Fusion Method for Motion Artifacts Reduction in Photoplethysmography Signal," *IEEE Trans. Instrum. Meas.*, 2020.
- [15] S. H. Browne *et al.*, "Maxim Integrated Smartphone Sensor With App Meets FDA/ISO Standards for Clinical Pulse Oximetry and Can Be Reliably Used by a Wide Range of Patients," *Chest*, 2020.
- [16] M. C. Chang, Y.-K. Park, B.-O. Kim, and D. Park, "Risk factors for disease progression in COVID-19 patients," *BMC Infect. Dis.*, vol. 20, no. 1, pp. 1–6, 2020.
- [17] S. C. Mukhopadhyay, "Wearable sensors for human activity monitoring: A review," *IEEE Sens. J.*, vol. 15, no. 3, pp. 1321–1330, 2014.
- [18] S. Nabavi and S. Bhadra, "Smart Mandibular Advancement Device for Intraoral Monitoring of Cardiorespiratory Parameters and Sleeping Postures," *IEEE Trans. Biomed. Circuits Syst.*, vol. 15, no. 2, pp. 248–258, 2021.
- [19] S. Nabavi, S. Debbarma, and S. Bhadra, "Measurement of Cardiac Parameters by Motion Artifacts Free Photoplethysmography Signals," in *Proc. IEEE International Instrumentation and Measurement Technology Conference (I2MTC)*, 2020, pp. 1–6.