

A Headset Like Wearable Device to Track COVID-19 Symptoms

Radovan Stojanović
Faculty of Electrical Engineering
University of Montenegro and MECOnet
Podgorica, Montenegro
stox@ucg.ac.me

Budimir Lutovac
Faculty of Electrical Engineering
University of Montenegro
Podgorica, Montenegro
budo@ucg.ac.me

Andrej Škraba
Faculty of Organizational Sciences
Cybernetics & Decision Support Systems Laboratory
University of Maribor
Kranj, Slovenija
andrej.skraba@um.si

Abstract – A wearable system/device capable to track key COVID-19 symptoms is presented. Off-the-shelf hardware and software components as simple sensors, general purpose microcontroller, and gadget like mobile devices and peripherals are used to detect and monitor body temperature, heart rate, respiration rate and other vital signs, which are important to alert patients and remote medical staff about unusual symptoms correlated to COVID-19 or similar diseases. The basic idea about measuring principle, system integration, digital signal processing and networking is presented and accompanied with preliminary testing results. The principle is not just simple and low cost, based on the components we use every day, but very immune to noise and artifacts.

Keywords - COVID-19, wearable device, symptoms, Arduino, sensors, temperature, heart rate, alerting, monitoring.

I. INTRODUCTION

Wearables in healthcare and general medicine are electronics, measurement, telecommunication and multimedia devices capable to detect and monitor vital signs like heart rate (HR), body temperature (BT), blood pressure (BP), glucose concentration, oxygen saturation (SpO2) and others. Measuring vital signs is the first step in diagnosing medical problems and it can be done at home, medical ambulance, emergency, work place, or elsewhere. Almost all of us use smart watches, heart rate monitors, stress monitors, thermometers, blood pressure and glucometers and many other applications that are not just toys but powerful and useful instruments [1],[2],[3].

The COVID-19 is associated with typical symptoms. Their list is not short, but the most typical are: fever, cough, shortness of breath or other breathing problems, chills, muscle pain, sore throat, loss of taste or smell. Serious symptoms, among other, include elevated heart rate (above 100 bpm) and lower oxygen saturation <92%. The ideal COVID-19 wearable device would be capable of measuring as many mentioned parameters as possible in everyday conditions and being easy to use by the seniors, young, without special training and knowledge.

Here, we present an idea of how to measure vital signs using the devices we all have like mobile phone, headsets, thermistors and development boards like Arduino or similar. In addition to basic engineering and health care knowledge it is quite enough to suspect a disease and ask for help. The measuring set is a headset like which is very intuitive to use, shown in, Figure 1. In combination with the mask, the use of which is obligatorily during COVID-19 pandemic, the system gives better results, as the mask by itself is amplifying breathing signals. Additionally, the system can be networked via mobile devices to cloud and further general telemedicine network.

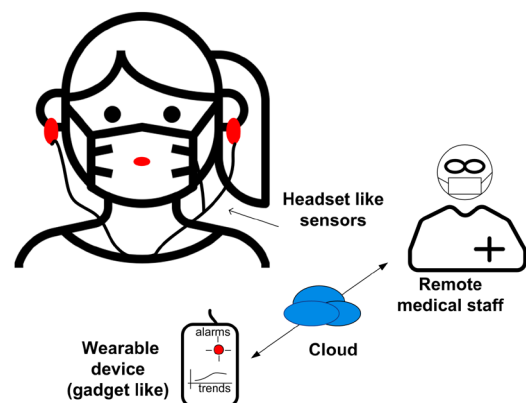

Figure 1. The idea of headset like COVID-19 symptoms tracker

II. DESIGN

The simplest sensor consists of any mobile phone with standard headset with built in microphone. It is attached to microphone/speakers input (via 3.5mm jack) and detects breathing problems, respiration rate and cough, Figure 2 a). As a sensor the built in microphone is used [4]. The audio signal is acquired by any voice recorder application on mobile phone. Then, the audio file is imported to computational application such as MATLAB or similar computation tool. In our experiments we used MATLAB and “wav” or “mp3” audio

formats. MATLAB mobile is also convenient for on spot measurement and calculation and with additional license audio acquisition plug in is available, therefore, all applications can be developed on the same platform. The audio (voice) signal is processed in time, frequency and time frequency domains. The features as respiration rate (RR), rapid or shorten breathing and caught are detected. The user can have audio feedback via earphones, for example sound alarm, when RR is above or below the threshold, or some breathing problems are present as rapid breathing, or intensified cough. This approach does not request any external component, expect earphones. Java based on-line application can be designed in mobile device in order to have a full autonomous system on a gadget.

The next configuration, configuration #2, is extended to more sensors and has an interface between mobile phone and headset, SDe, Smart Device that can be Arduino mini or micro board, powered by USB port of mobile phone, Figure 2 b). Temperature sensor (thermistor in form PTC or NTC) is embedded in earphone, while heart rate sensor is in the form of PPG ear-clip [5]. The respiration rate is measured using both principles: microphone and thermistor. The earphone is modified in a way that thermistor is mounted on surface of earpiece capsule. The second speaker is replaced with PPG clip. Before being acquired and processed by Arduino the signals are amplified by simple circuits based on standard operational amplifiers. Schematics of each amplifier are given in Figure 4. As seen, those circuits are very simple and extremely low cost, based on LM324 amplifier and few passive components. Only the sensor that should be used as standalone module is PPG ear clip. The significant part of the pre-processing has been done by hardware amplifiers, as amplifying, low pass and high pass filtering, envelope detecting, signal leveling and thresholding etc. The signals are then fed to A0...A3 analog inputs of Arduino.

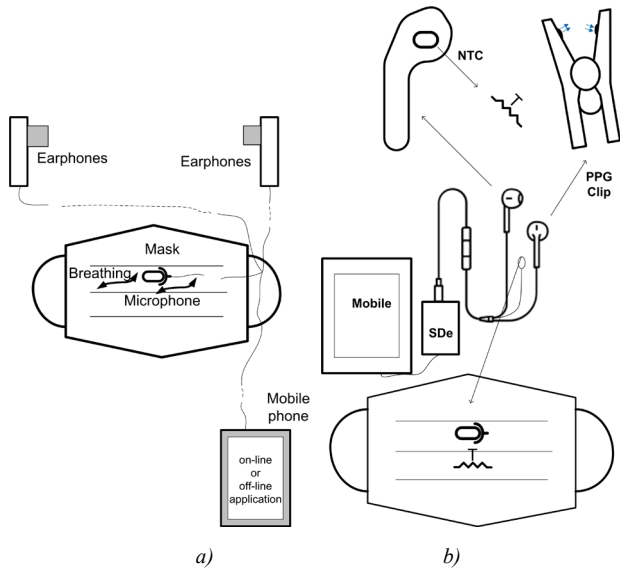

Figure 2. a) The respiration rate and breathing detection by using headset's microphone, configuration #1 b) heart rate, temperature and respiration rate detection using NTC thermistor, microphone and PPG sensor, configuration #2

The additional signal processing is done by Arduino, low pass filtering, high pass filtering, notch filtering, thresholding,

FFT (Fast Fourier Transform), thresholding, counting, displaying etc. (Figure 3.) The filters are software implemented in integer arithmetic to be fast with low memory usage. The positions of the adequate HR and RR peaks are calculated from FFT Spectrum. The FFT is implemented on Arduino, again in integer arithmetic, because of limited memory resources. The envelope detector of mic signal is thus implemented by amplifiers, converting audio signal to low frequency signal, reducing sampling frequency to 25Hz (the same sampling frequency is used for 4 signals).

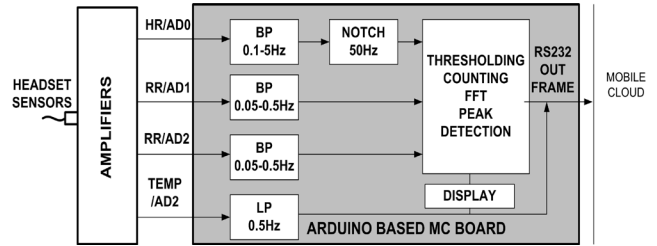

Figure 3. Block diagram of the Arduino based interface for processing vital signs.

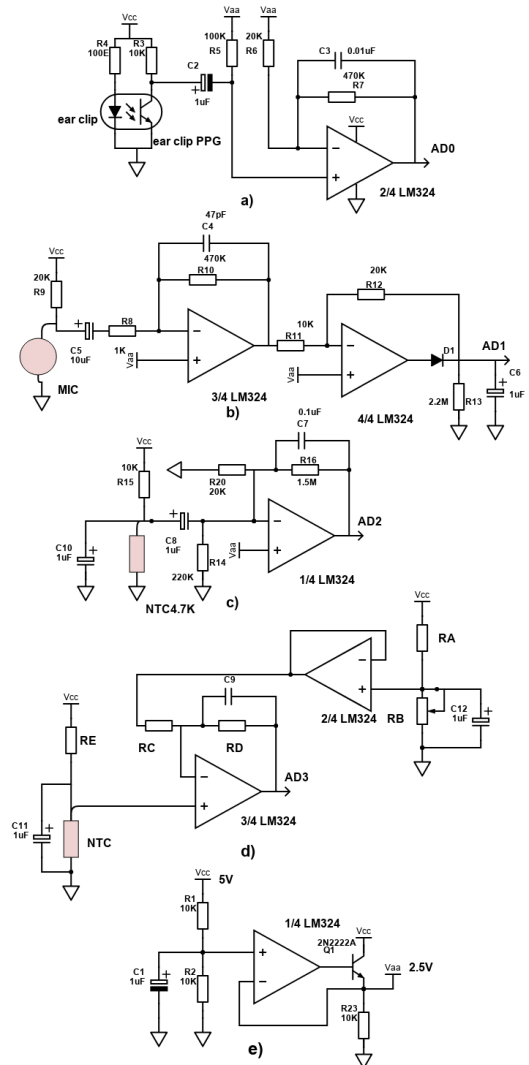

Figure 4. PPG, MIC, NTC and TEMP amplifiers

III. PRELIMINARY TESTING RESULTS

The approach is tested for both configurations: configuration #1 and configuration #2. In case of configuration #1, when only MIC is used as sensor, the signal is acquired by mobile phone application (voice recorder) and saved in adequate audio format “wav” or “mp3”. Then, “wav file” is processed by MATLAB using Hilbert transform and low pass filter for envelope detection and FFT for peak position detecting. The sampling frequency of origin signal is 32Khz. The AGC (Automatic Gain Control) is in order to improve sensitivity. The envelope signal is later down sampled by 25Hz. The respiration rate (RR) is calculated as a position of the peak in FFT (dominant frequency).

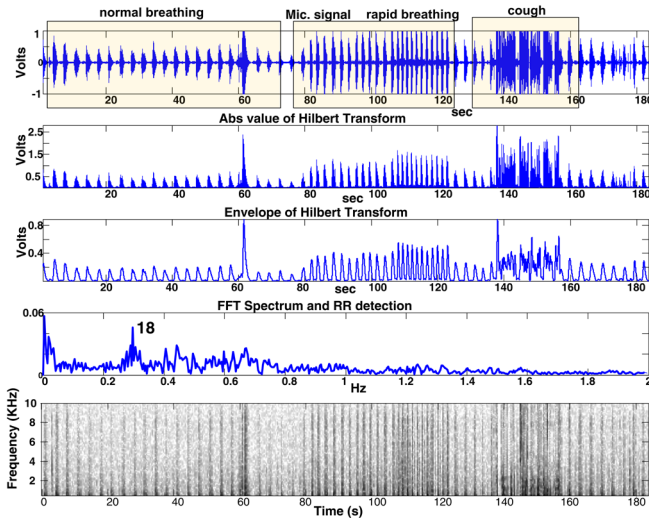

Figure 5. The acquired MIC signal, $f_s=32\text{KHz}$ (first diagram from top to bottom). The absolute value of Hilbert transform of original signal (second diagram). The envelope signal of breathing (third diagram). FFT spectrum of breathing envelope signal (forth diagram). Dominant RR frequency for input signal in 180 seconds. STFT (Short Time Furier Transform) of the input signal (time frequency analyze).

As seen from Figure 5, it is not recommended to estimate RR from the spectrum of long term voice signal, as example 3 min signal, because the calculation of dominant frequency is in long window and does not reflect the real situation. As example, the periods of rapid breathing will be averaged, as is seen in Figure 5, the average RR in 3 mins was 18 breaths/min, although we had periods with rapid breathing. To overcome this situation it is better to use windowed FFT in form of STFT, and to extract dominant frequency from consequent windows, Figure 6, which can be overlapped. In this case, here we got better RR resolution over time, 18 breaths/min during 1st segment of 60 seconds, 28 and 40 during 2nd segment and 18 breaths/sec during 3rd segment. 4th diagram (top do down) in Figure 6 illustrates the time segment when cough is detected. Envelope of cough is specific, does not have periodicity and can be considered as a noise like artifact.

In case of the configuration #2 the signals are transformed in low frequency domain, by hardware preprocessing by using analog circuits from Figure 4. Then, additional processing is implemented by software filters on Arduino side, Figure 3. All, NTC, Microphone and PPG signals are well filtered,

Figure 7. The HR and RR are calculated from adequate sample using FFT spectrum by peak detection. As seen in Figure 8, the matching in peak detection for both MIC and NTC signals is satisfactory. Figure 9 shows real signal with noise and cough where the dominant value of RR is detected from FFT Spectrum.

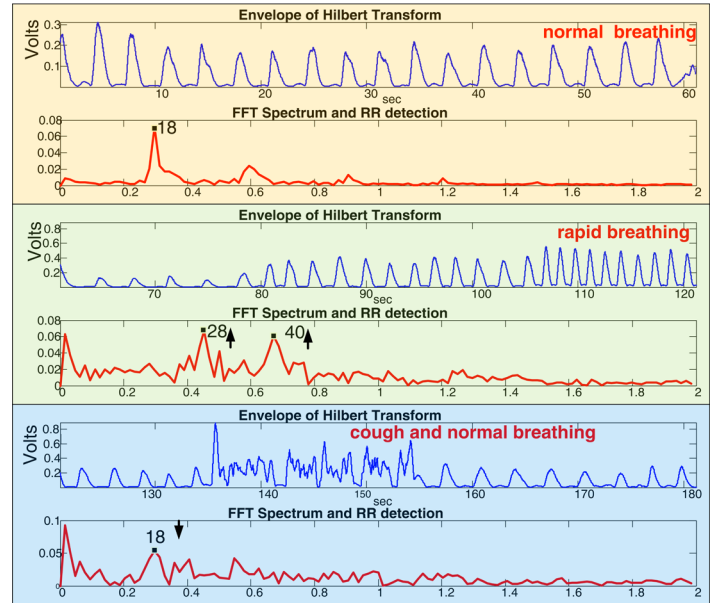

Figure 6. The windowed MIC signal processed by FFT. The better time resolution of RR detection.

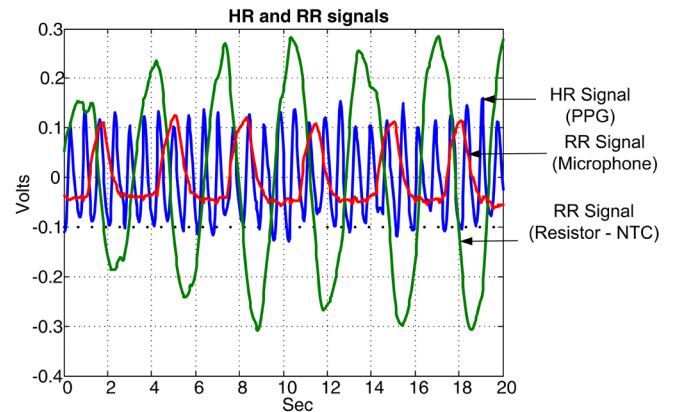

Figure 7. The PPG and RR signals obtained by circuits from Figure 4 and Arduino processing

IV. CONCLUSIONS

The paper presents a low cost and flexible design of medical device for purposes of detecting and tracking symptoms of COVID_19. The simplest configuration only uses headsets and mobile phone and it is capable of detecting respiration problems. The principle can be extended to more sensors for tracking heart rate, temperature and oxygen saturation. The simplest analog circuits for signal preprocessing are given. Also, the methodology of software processing and feature extraction on microcontroller side is presented. The approach yielded good and stable results and could be considered as one of the feasible solutions in symptoms detection during COVID-19.

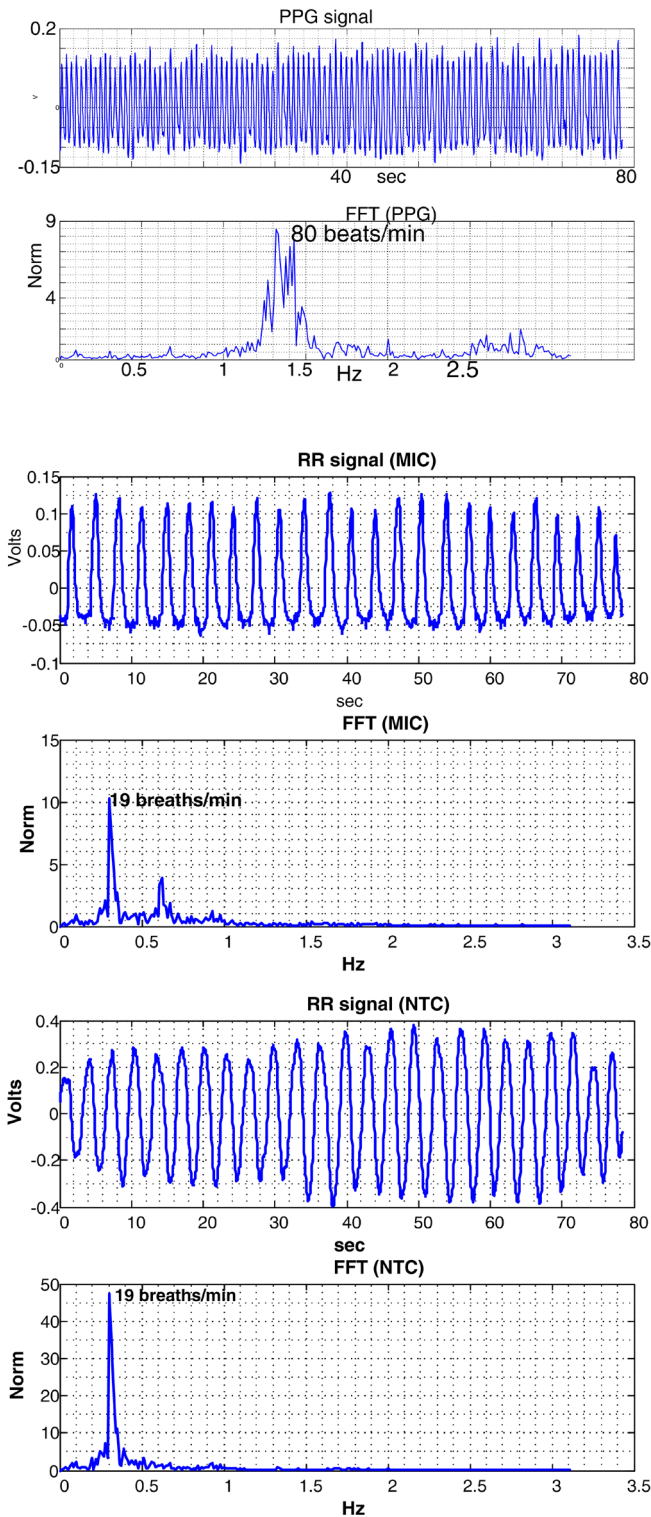

Figure 8. HR and RR detection using analog front end and Arduino post processing. From top to above: 1st, PPG signal obtained by ear clip and processed by amplifier and Arduino. 2nd, Calculation HR from FFT spectrum. 3rd, RR signal obtained after analog and digital processing of microphone signal, 4th, RR calculated from FFT spectrum of microphone signal, 5th, RR signal obtained by NTC resistor, 6th FFT spectrum and dominate frequency in this case.

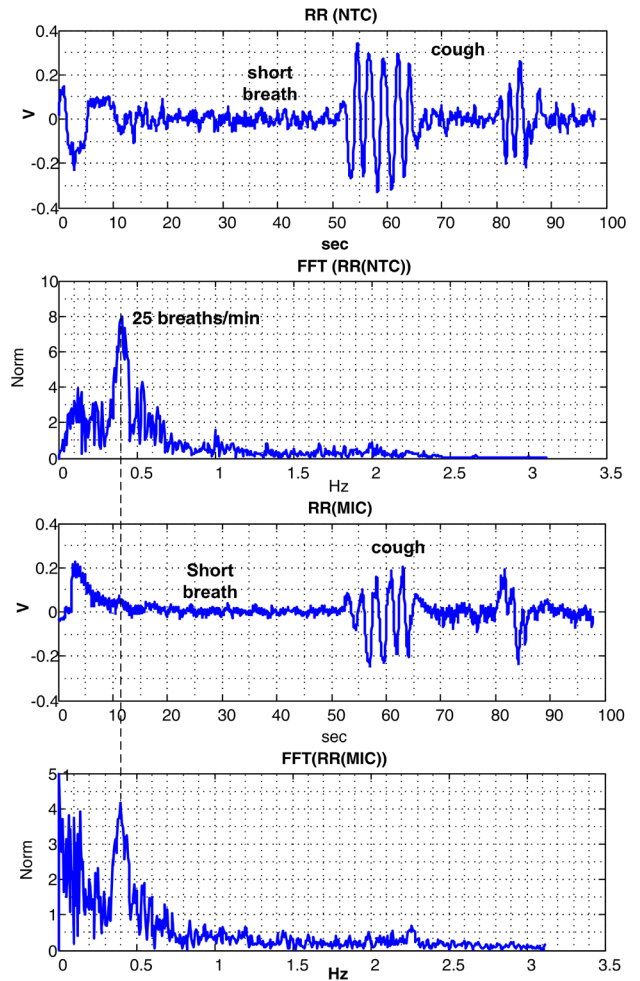

Figure 9: Real signal with noise and cough. The dominate RR is detected from FFT Spectrum.

ACKNOWLEDGEMENT

The authors are thankful to H2020 Project “SMART4ALL: Self-sustained customized cyberphysical system experiments for capacity building among European stakeholders”, No: 872614, for support in performing research related to this paper.

REFERENCES

- [1] C. Massaroni, A. Nicolò, D. Lo Presti, M. Sacchetti, S. Silvestri and E. Schena, Contact-Based Methods for Measuring Respiratory Rate, *Sensors* 2019, 19, 908
- [2] A.Škraba, A.Koložvari, D.Kofjač, R.Stojanović, V.Stanovov, E.Semenkin. “Streaming pulse data to the cloud with bluetooth LE or NODEMCU ESP8266,” *6th Mediterranean Conference on Embedded Computing (MECO)*, Bar, Montenegro. 12-16 June 2016, pp.428–431.
- [3] A.Škraba, A.Koložvari, D.Kofjač, R.Stojanović, V.Stanovov, E.Semenkin. “Prototype of Group Heart Rate Monitoring with NODEMCU ESP8266,” *6th Mediterranean Conference on Embedded Computing (MECO)*, Bar, Montenegro. 11-15 June 2017, pp.534-537.
- [4] D.Kofjač, R.Stojanović, A.Koložvari, A.Škraba. “Designing a low-cost real-time group heart rate monitoring system,” *Microprocessors and Microsystems* 63, pp.75–84, 2018.
- [5] Budidha, K.; Kyriacou, P.A. The human ear canal: Investigation of its suitability for monitoring photoplethysmographs and arterial oxygen saturation. *Phys. Meas.* 2014, 35, 111–128.