

Electromagnetic Time Reversal Method to Locate Partial Discharges in Power Networks Using 1D TLM Modelling

A. Ragusa¹, Member, IEEE, H. Sasse, A. Duffy², Fellow, IEEE, F. Rachidi³, Fellow, IEEE, and M. Rubinstein, Fellow, IEEE

Abstract—This letter sets out to describe the first results of the design process that will lead to a new on-line partial discharge location method based on Electromagnetic Time Reversal theory and using the Transmission Line-Matrix method. A description of the basic steps of the method under design is given together with the modeling procedure used to describe time inverted signal propagation. Finally, the ability of the method to locate partial discharges on power cables both using two observation points and a single observation point is proved in simulation.

Index Terms—Partial discharge, on-line location, monitoring, electromagnetic time reversal (EMTR), transmission line, transmission line-matrix (TLM), network resilience.

I. INTRODUCTION

AMONG all forms of energy, electricity plays a central role in the global challenge of climate change and the shift to clean growth. An increased amount of consumed electricity is expected in the transport, heating and service sectors. Electricity security is the power system's capability to withstand or cope with disturbance events or incidents producing abnormal system conditions, failures or outages of system components, with minimal service disruption [1]. Insulation degradation of cables in distribution and transmission networks produces effects ranging from temporary faults to complete black-out. Statistics indicate that more than 85% of equipment failures are related to insulation failure [2]. Insulation degradation is often caused by or accompanied by Partial Discharge (PD) events, which makes detecting and locating PDs an excellent 'early warning' indicator of impending cable failure. PDs start in insulation defects, usually formed during the manufacturing or

Manuscript received August 22, 2020; revised October 09, 2020; accepted October 15, 2020. Date of publication October 20, 2020; date of current version February 23, 2021.

This work was supported by the European Union's Horizon 2020 Research and Innovation Programme under the Marie Skłodowska-Curie Grant under Agreement 838681. (Corresponding author: A. Ragusa.)

A. Ragusa, H. Sasse, and A. Duffy are with the School of Engineering and Sustainable Development, De Montfort University, Leicester LE1 9BH, U.K. (e-mail: antonella.ragusa@dmu.ac.uk; hgs@dmu.ac.uk; apd@dmu.ac.uk).

F. Rachidi is with the Electromagnetic Compatibility Laboratory, Engineering School, École Polytechnique Fédérale de Lausanne, 1015 Lausanne, Switzerland (e-mail: farahd.rachidi@epfl.ch).

M. Rubinstein is with the Institute for Information and Communication Technologies, University of Applied Sciences and Arts Western Switzerland, 1401 Yverdon-les-Bains, Switzerland (e-mail: marcos.rubinstein@heig-vd.ch).

Digital Object Identifier 10.1109/LEMCPA.2020.3032465

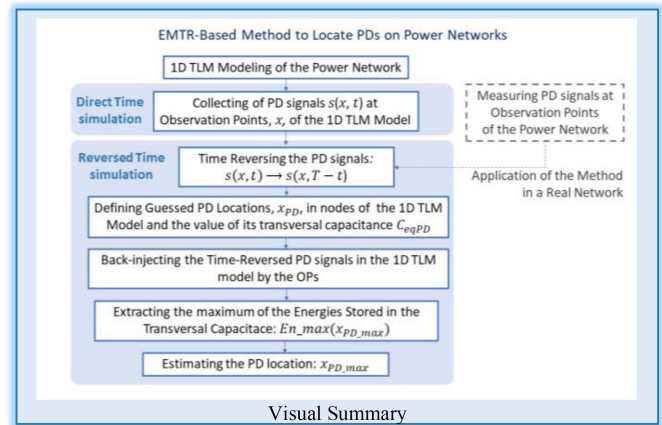

installation process or in insulation deteriorated with age or by thermal/electrical over-stressing. Hence, the adoption of on-line PD detection and location methods is the most effective solution for the condition monitoring of networks to prevent faults and supply interruption, leading to a better power quality, an increased customer satisfaction and an improvement of network resilience [3]. The on-line PD detection and location problem has been widely investigated in the literature [2]–[6]. Most on-line location methods are reflectometry or traveling wave-based techniques, using the principle that PD events generate electromagnetic waves that travel in either direction towards the cable ends. A measurement system at one end

Take-Home Messages:

- The first results of the design of a method for the location of Partial Discharges (PDs) on power networks based on the innovative Electromagnetic Time Reversal (EMTR) theory and using a 1D TLM model of PD signals propagation are presented.
- The results demonstrate that EMTR theory is a promising mean to locate PDs using only one measurement point.
- The proposed technology, in the field of electromagnetic disturbance source-location identification, addresses the persisting question of the on-line diagnosis of power networks in order to improve their resilience.
- The EMTR-based method is able to locate PDs using only one measurement point, overcoming the complexities due to synchronization procedures of the existing reflectometry-based multi-end measurement methods.

of the cable detects two pulses, the incident wave and the reflected one from the other cable end. The delay between these pulses allows an estimate of the PD location. Time domain reflectometry (TDR) methods can only be used for short cables because otherwise accuracy is lost due to attenuation and dispersion phenomena. Multi-end measurement methods (ToA methods) [5] are used to address this problem, but their implementation is difficult due to the complexity in the synchronization procedure. Furthermore, ToA methods require a precise determination of the signal onset time, which is highly sensitive to noise. Another major challenge in accurately locating PDs is the presence of electromagnetic interference (EMI), addressed using wavelet transform techniques requiring significant computational effort [6].

This letter describes the first results of the design procedure of a new method for the on-line location of PDs in distribution and transmission networks based on the innovative theory of electromagnetic time reversal (EMTR) [7] and using a 1D Transmission Line Matrix (TLM) method to model the PD signal propagation. EMTR theory has already been applied to the location of lightning strikes and faults in power networks [8], [9] with significantly improved performance compared to classical approaches, such as: applicability to inhomogeneous and complex networks; robustness against the presence of noise and a limited observation time window; use of a single observation point. Moreover, the EMTR method used to locate lightning can be considered a more general case compared to ToA methods and is able to use information about the wave shape of the lightning interference together with the propagation time. EMTR has previously not been used to locate incipient faults such as PDs which exhibit different characteristics compared to solid faults. PD pulses are short with significant frequency components of up to 1 GHz and the accuracy of their location is influenced to a much greater extent compared to classical faults by distortion phenomena and by the presence of EMI. All these characteristics make EMTR a good candidate technique to solve the highlighted factors affecting the accuracy of PD location methods.

II. 1D TLM MODEL OF SIGNAL PROPAGATION

The propagation of PD signals in a lossless transmission line formed by a single wire above a ground plane or a shielded cable, represented by the equivalent circuit in Fig. 1, is described by the Telegrapher's equations that give voltage, $v(x, t)$, and current, $i(x, t)$ wave on the line as functions of time t and distance x [10]:

$$\frac{\partial^2 v(x, t)}{\partial t^2} = \frac{1}{LC} \frac{\partial^2 v(x, t)}{\partial x^2} \quad (1.1)$$

$$\frac{\partial^2 i(x, t)}{\partial t^2} = \frac{1}{LC} \frac{\partial^2 i(x, t)}{\partial x^2} \quad (1.2)$$

where L and C are, respectively, the inductance and capacitance (per unit-length) of the transmission line. The transmission line is thus characterized by a propagation speed, u , and a characteristic impedance, Z_0 , [10]:

$$u = \frac{\Delta x}{\Delta t} = \frac{1}{\sqrt{LC}}; \quad Z_0 = \sqrt{\frac{L}{C}} \quad (2)$$

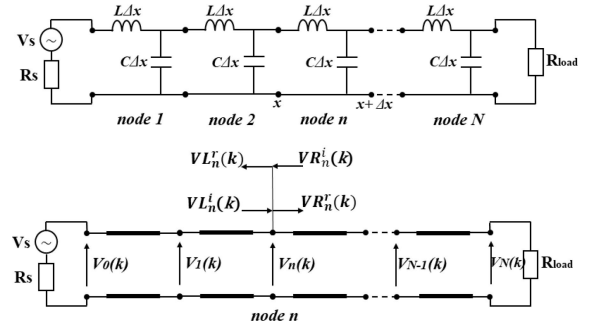

Fig. 1. Equivalent circuit of a line (top) and its TLM model (bottom).

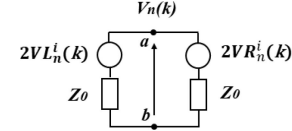

Fig. 2. Transmission line Thevenin equivalent.

Voltage and current waves are evaluated using the TLM method, chosen for its flexibility, high efficiency, and its numerical stability. It is a differential equation-based method operating in time-domain, where the transmission line is discretized into a mesh of n segments, of length Δx , connected by nodes as shown in Fig. 1. The wave pulses are scattered in the nodes and propagate in the transmission lines, generating incident and reflected voltages/currents. The voltage at time-step k at the node n , $V_n(k)$, evaluated by applying Millman's "Parallel Generator" theorem to the Thevenin equivalent circuit of the line shown in Fig. 2, and the node current, $I_n(k)$ are:

$$V_n(k) = \frac{2VL_n^i(k) + \frac{2VR_n^i(k)}{Z_0}}{\frac{1}{Z_0} + \frac{1}{Z_0}} \quad (3.1)$$

$$I_n(k) = \frac{V_n(k) - 2VR_n^i(k)}{Z_0} \quad (3.2)$$

where $VL_n^i(k)$ and $VR_n^i(k)$ are the incident voltages coming respectively from the left and the right of node n . The reflected voltages on the left, $VL_n^r(k)$, and on the right, $VR_n^r(k)$, of the node are:

$$VL_n^r(k) = V_n(k) - VL_n^i(k) \quad (4.1)$$

$$VR_n^r(k) = V_n(k) - VR_n^i(k) \quad (4.2)$$

The voltage incident from the left of node n at time step $k+1$ is the reflected into the right of node $n-1$ at the time-step k ; and the same considerations apply to the incident voltage on node n coming from the right. In a node of the line where a PD event occurs, an electromagnetic disturbance, V_{PD} , is produced, and for the purpose of this illustration, it can be represented with a double exponential equation [11]:

$$V_{PD} = V_0 \left(-e^{-\frac{t}{\tau_1}} + e^{-\frac{t}{\tau_2}} \right) \quad (5)$$

with $V_0 = 0.1$ V, $\tau_1 = 2$ ns, $\tau_2 = 10$ ns. This voltage is applied to one node of the TLM model, between points a and b of Fig. 2, and its propagation along the cable is evaluated using eqs. (3-4).

III. EMTR-BASED LOCATION METHOD

The EMTR-based method to locate PDs is derived from the EMTR method to locate faults on power networks [9]. At a point on the line, illustrated in Fig. 3, a PD event occurs. To locate the PD source, the proposed EMTR-based method is based on the following steps:

1. measurement of the PD-originated signals at observation points (OPs) of the line, shown in Fig. 3;
2. simulation of the back-injection of the time-reversed PD signals for different guessed PD locations (GPDs) using the 1D TLM model;
3. assessment of the PD location by evaluating the GPDs characterized by the highest energy concentration related to the back-injected time-reversed PD signals.

The method is designed considering either two OPs or one OP. To give the mathematical proof of the method, a Direct Time (DT) simulation is run, during which a PD event occurs at a node of the cable, producing the electromagnetic signal, V_{PD} , described by eq. (5). This propagates towards the cable ends where the PD signals, $s(t)$, are recorded at the OPs, shown in Fig. 3, in a specific time window, T . The recorded signals are time-reversed and back injected, from the OPs, into the TLM model of the line to run the Time Reversal (TR) simulations. To make the argument of the time-reversed variables positive during the TR simulations, a time delay equal to T is applied:

$$\hat{t} = T - t \quad \text{with} \quad \bar{s}(\hat{t}) \quad \hat{t} \in [0, T] \quad (6)$$

For each TR simulation, a GPD is defined as a node of the TLM model of the network that reproduces the transversal impedance between the inner conductor and external shield of the cable when a PD event occurs inside the insulator. A PD event in a cavity within a dielectric can be modelled using the well-known three-capacitor circuit model [12] shown in Fig. 4, where C_a and C_b represent the capacitance in the dielectric material in series with a defect and C_c is the defect capacitance. The discharge event is represented by an instantaneous change in the charging of the system capacitance, realized by closing the switch in Fig. 4. The value of the defect capacitance, C_c , can be evaluated by using the generalized PD model described by Niemeyer [13]. According to this model, the charges $\pm q$ that represent the surface charge distribution in the defect surface due to the voltage collapse, ΔV_{PD} , caused by the PD event, are given by:

$$\pm q = \pm g \pi \varepsilon_0 d \Delta V_{PD} \quad (7)$$

where ε_0 is the vacuum permittivity, d is the defect scale, i.e., the defect dimension parallel to the local background electric field, g is a dimensionless proportionality factor accounting for the charge distribution form, the defect geometry, and the influence of the relative permittivity. The value of C_c can be evaluated from (7):

$$C_c = g \pi \varepsilon_0 d \quad (8)$$

For a generic defect type, shown in Fig. 4, g is given by [12]:

$$g(a/b, \varepsilon_r) = \frac{1}{2} \frac{a/d}{(a/b)^2} [1 + \varepsilon_r (K(a/b) - 1)] \quad (9)$$

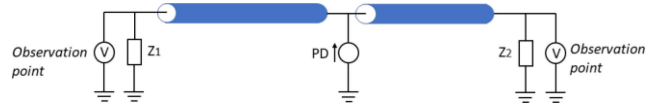

Fig. 3. Schematic representation of the line with a PD event along the cable and two OPs at the cable ends.

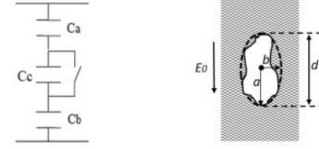

Fig. 4. Three-capacitor circuit model of PD (left) and a generic defect inside the insulation where PD occurs (right).

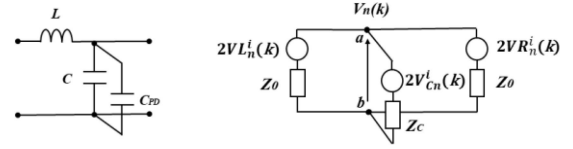

Fig. 5. TLM GPDL node with a capacitive stub (left) and the Thevenin equivalent circuit (right).

with ε_r the relative dielectric permittivity of the dielectric in the vicinity of the defect, a and b defined in Fig. 4 and $K(a/b)$ given by:

$$K(a/b) = \begin{cases} \cong 1 & a/b \ll 1 \\ 3 & a/b = 1 \\ \cong 4a/b & 1 < a/b < 10 \end{cases} \quad (10)$$

For a spherical void with $d = 2a = 2b$ and $K = 3$, the value of C_c is:

$$C_c = \pi \varepsilon_0 d \frac{1}{4} [1 + 2\varepsilon_r] \quad (11)$$

Then, in the TR simulations, the impedance at each GPD is characterized by a capacitance C_{eqPD} given by the series of C_a and C_b with C_c short-circuited. In the TLM model, the value of C_{eqPD} is realized, as shown in Fig. 5, using, in parallel with the node transversal capacitance C , a stub capacitor [10], C_{PD} . In the Thevenin equivalent circuit of the line, the GPD node is shown in Fig. 5 where the stub capacitance is characterized by an impedance, Z_c , given by:

$$Z_c = \Delta t / 2C_{PD} \quad (12)$$

In order to locate the PD source, at each GPD, the Energy, E_n , stored in the transversal capacitance is evaluated as follows:

$$E_{nGPDL} = \frac{1}{2} C_{eqPD} \sum_{i=1}^M V_i^2 \quad \text{with} \quad M = T/\Delta t \quad (13)$$

where V is the voltage at the node, M is the number of samples, Δt the sampling time and T the observation period. The normalized value, E_{norm} , is then evaluated, for each GPD, with respect to the maximum Energy in the GPDs:

$$E_{norm} = \frac{\frac{1}{2} C \sum_{k=1}^M V_{GPDL}^2(k)}{\frac{1}{2} C \sum_{k=1}^M V_{GPDL_m}^2(k)} = \frac{\sum_{k=1}^M V_{GPDL}^2(k)}{\sum_{k=1}^M V_{GPDL_m}^2(k)} \quad (14)$$

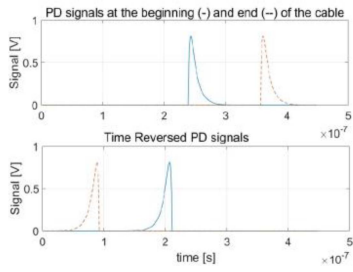

Fig. 6. PD signals measured at the two OPs in DT simulation with a PD source 40 m far from the left end of the cable and the Time Reversed signals.

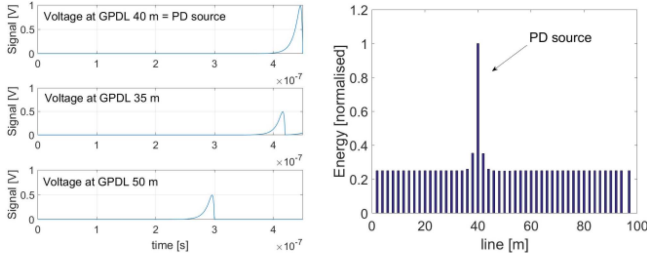

Fig. 7. Voltage at three GPDs and the energy in several GPDs in the TR simulation when 2 OPs are used, and the PD is 40 m from the line left end.

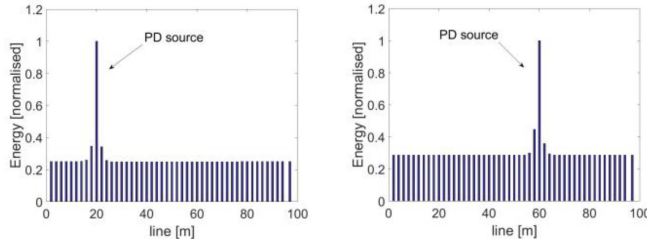

Fig. 8. Normalized energy in several GPD when PD source is 20 m and 60 m far from the left end of the cable when 2 OPs are used.

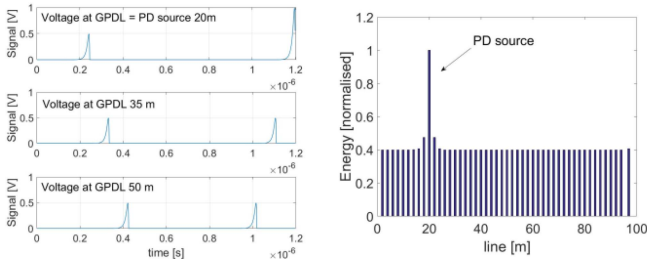

Fig. 9. Voltage in three GPDs and the Energy in several GPDs in the TR simulation when 1 OP is used, and the PD is 20 m from the line left end.

The PD source is in the GPDL characterized by the maximum value of the Energy.

IV. SIMULATION RESULTS

To give an illustration of the proposed method, simulations have been performed based on the scheme in Fig. 3: that is, a transmission line formed of a homogeneous cable of length $l = 100$ m, connected to impedances Z_1 and Z_2 with $Z_1 = Z_2 = 100$ k Ω (representing the power transformers impedance at high frequency). The cable is an 11-kV aluminum power cable, with Cross-Linked Polyethylene (XLPE)

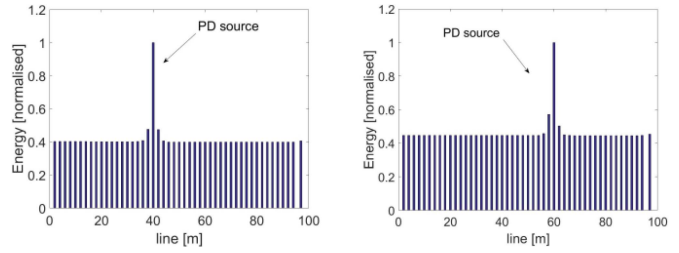

Fig. 10. Normalized energy in several GPDs when PD source is 40 m and 60 m far from the left end of the cable when 1 OP is used.

insulation and cross-sectional area of 150 mm^2 , with characteristic parameters equal to $L = 91.34 \text{ nH/m}$, $C = 0.39 \text{ nF/m}$, characteristic impedance $Z_0 = 15.30 \Omega$ and propagation speed $u = 1.675 \times 10^8 \text{ m/s}$. The GPDL impedance in the TR simulations is evaluated using eqs (6)-(13). For an XLPE cable with $\epsilon_r = 2.3$ and for a sphere defect with $a = b = 1 - 5 \text{ mm}$, the value of $C_c \cong 10^{-13} - 10^{-14} \text{ F}$ and $C_{PD} \cong 10^{-18} \text{ F}$. The recording time T , when two OPs are used, must be equal to $T = l/u = 0.6 \mu\text{s}$, i.e., the propagation time along the cable, in order to measure the PD signals at both the OPs whenever the PD event occurs. Fig. 6 shows the PD signals measured at the OPs in the DT simulation, with a PD source 40 m away from the left end of the cable, and the corresponding time reversed signals. Fig. 7 shows the voltage at three GPDs and the normalized energy evaluated at several GPDs in the TR simulation. A GPDL was defined every 2 m along the cable. As the figure shows, the GPDL with the maximum energy is the PD source location. It can also be observed that the voltage at the GPDL that corresponds to the PD source is higher than the voltage at the other GPDs. This is because the back-injected signals add up in phase at the real PD location. Fig. 8 shows the results when the PD source is placed, respectively, 20 m and 60 m from the left end of the cable. The proposed method is also able to locate the PD source using only one OP. In this case, the recording time must be defined to measure at the OP the direct PD signal and some PD signal reflections from the other end of the cable. A value $T = 2 \cdot l/u = 1.2 \mu\text{s}$ has been used. Fig. 9 shows the voltage at different GPDs when the PD source is 20m from the left end of the cable (where there is the OP) and the normalized energy in several GPDs. Fig. 10 shows the method results when the PD source is, respectively, 40 m and 60 m away from the left end of the cable. As the figures show, the method can locate the PD also using only one observation point.

V. CONCLUSION AND FUTURE WORK

The letter proposes a new method for the on-line location of PD sources on power networks based on EMTR theory using a 1D TLM model of the PD signal propagation. An illustration of the method is provided and the ability of the method to locate PD events using only one observation point is demonstrated. The design of the method has been developed considering a simple system formed by a homogeneous Medium Voltage cable and using a lossless model of the transmission line. Future work includes the validation

of the method in complex network topologies (inhomogeneous cables and branched networks) to introduce losses and analyze the effect of this on the accuracy of the method to locate PDs. Moreover, an analysis of the effect of the parameter $K(a/b)$, that defines the value of C_c in the GPDL, will be carried out in order to verify if its value affects the behavior/profile of the energy bar chart. This will potentially allow the method to give information about the type, geometry and dimensions of the defect where PD occurred in addition to only locating its source.

REFERENCES

- [1] G. Fulli, F. Profumo, and E. Bompard, *Electricity Security in the EU: Features and Prospects*, Joint Res. Centre, Brussels, Belgium, Aug. 2018.
- [2] S. Refaat and M. Sham, "A review of partial discharge detection, diagnosis techniques in high voltage power cables," in *Proc. IEEE Conf. Compat. Power Electron. Power Eng.* Doha, Qatar, 2018, pp. 1–5.
- [3] F. Auzanneau, "Wire troubleshooting and diagnosis: Review and perspectives," *Progr. Electromagn. Res. B*, vol. 49, pp. 253–279, Feb. 2013.
- [4] M. S. Mashikian, R. Bansal, and R. B. Northrop, "Location and characterization of partial discharge sites in shielded power cables," *IEEE Trans. Power Del.*, vol. 5, no. 2, pp. 833–839, Apr. 1990.
- [5] C. C. Yii, M. N. K. H. Rohani, M. Isa, and S. I. S. Hassan, "Multi-end PD location algorithm using segmented correlation and trimmed mean data filtering techniques for MV underground cable," *IEEE Trans. Dielectr. Electr. Insul.*, vol. 24, no. 1, pp. 92–98, Feb. 2017.
- [6] A. M. Gaouda, A. El-Hag, T. K. Abdel-Galil, M. M. A. Salama, and R. Bartnikas, "On-line detection and measurement of partial discharge signals in a noisy environment," *IEEE Trans. Dielectr. Electr. Insul.*, vol. 15, no. 4, pp. 1162–1173, Aug. 2008.
- [7] F. Rachidi *et al.*, *Electromagnetic Time Reversal—Application to Electromagnetic Compatibility and Power System*. Hoboken, NJ, USA: Wiley, 2017.
- [8] G. Lugrin, N. Mora, F. Rachidi, M. Rubinstein, and G. Diendorfer, "On the location of lightning discharges using time reversal of electromagnetic fields," *IEEE Trans. Electromagn. Compat.*, vol. 56, no. 1, pp. 149–158, Feb. 2014.
- [9] S.-Y. He *et al.*, "Norm criteria in the electromagnetic time reversal technique for fault location in transmission lines," *IEEE Trans. Electromagn. Compat.*, vol. 60, no. 5, pp. 1240–1248, Oct. 2018.
- [10] C. Christopoulos, *The Transmission-Line Modeling Method—TLM*, New York, NY, USA: Inst. Elect. Electron. Eng., 1995.
- [11] B. Sheng *et al.*, "Partial discharge pulse propagation in power cable and partial discharge monitoring system," *IEEE Trans. Dielectr. Electr. Insul.*, vol. 21, no. 3, pp. 948–956, Jun. 2014.
- [12] N. Kartalović, D. Kovačević, and S. Milosavljević, "An advanced model of partial discharge in electrical insulation," *Facta Universitatis Electron. Energetics*, vol. 24, no. 1, pp. 43–57, Apr. 2011.
- [13] L. Niemeyer, "A generalized approach to partial discharge modeling," *IEEE Trans. Dielectr. Electr. Insul.*, vol. 2, no. 4, pp. 510–528, Aug. 1995.