

Design and Analysis of New Modular Stator Hybrid Excitation Synchronous Motor

Shengnan Wu, *Member IEEE*, Yukun Wang, and Wenming Tong, *Member, IEEE*

Abstract—Hybrid excitation motor is a combination of permanent magnet motor and electric excitation motor, which can flexibly adjust the air gap magnetic field. At present, the traditional silicon steel sheet core material is widely used, but this material limits the further reduction of stator iron loss. In this paper, a new type of hybrid excitation synchronous motor with modular stator structure based on amorphous alloy material is proposed. The design power is 1kW, and the speed is 3000rpm. By placing the armature winding and electric excitation winding in the stator slot, the slip ring and brush are avoided, and the reliability of the motor is improved. The rotor adopts staggered magnetic pole structure, which has strong flux adjusting ability. The core loss is greatly reduced by using amorphous alloy. Firstly, the structure and working principle of the new motor are given; Secondly, the size parameters of the motor are given, and the principle of flux adjustment is verified and analyzed by three-dimensional finite element(3D-FEM); Finally, through theoretical analysis of the influence factors of the magnetic adjustment ability and 3D-FEM finite element computation, the flux adjustment ability and the torque lifting at low speed are verified, and the advantages of the motor are verified.

Index Terms—hybrid excitation synchronous machine; 3D-FEM; Amorphous alloy stator core.

I. INTRODUCTION

HYBRID excitation motors are the development of traditional single excitation motors. Hybrid excitation motors can not only inherit many characteristics of permanent magnet motors, but also save the amount of rare earth permanent magnets as an expensive strategic resource[1]. The air gap flux of the hybrid excitation motor is provided by the field DC current on the stator and the permanent magnet on the rotor. It is convenient to adjust the flux for hybrid excitation motor by adjusting DC current. Traditionally, the d-axis current can adjust the flux, but the effect is limited. As a motor, it has

strong field weakening ability and a wide range of speed regulation. At low speed, it can output larger torque by enhancing magnetization. When running as a generator, it has the ability to stabilize the output voltage, so this kind of motor has a very broad prospect[2].

Scholars at home and abroad have studied hybrid excitation motors, and the main types of motors are as follows. Literature [3] proposed a hybrid excitation motor with a magnetic shunt structure, but the motor has more additional air gaps, which affects the ability to adjust the magnetization. The axial placement of the electric field winding makes the axial length of the motor longer. Literature [4]-[5] studied a hybrid excitation switched flux double salient pole motor. The rotor structure of the motor is simple and reliable, but this type of torque ripple is relatively large. Literature [6] studied a dual-axis hybrid excitation motor, which has a high core utilization rate and simple adjustment of the magnetic field. However, when the electric field winding is located on the rotor, brushes and slip rings must be involved, which reduces the reliability of the motor. At the same time, the heating of the electric field winding on the rotor will also affect the reliability of the motor. Literature [7] proposed a dual-rotor radial hybrid excitation motor, in which armature windings are placed on the inner side of the stator, and electric excitation windings are placed on the outer side of the stator. The structure is more complicated and the windings are all inside, and the windings are separated from the outside by two layers of air gaps, so heat is difficult to conduct to the outside. Literature [8] and [9] studied the hybrid excitation motor with a staggered magnetic pole structure. A thick magnetic back yoke was used to provide axial magnetic flux, and the stator material was made of silicon steel sheet, so the iron loss was relatively large at high frequency.

This article innovatively proposes a hybrid excitation motor with a new modular stator structure using amorphous alloys and a staggered magnetic pole rotor structure. Amorphous alloy is a new type of double green soft magnetic material with high magnetic permeability and low loss. Used in motors, it can effectively reduce motor core loss and improve motor efficiency [10]. The new modular structure allows both the armature winding and the electric field winding to be wound on the stator teeth, which is flexible and convenient for installation. And the electric excitation winding is located on the stator side to help conduct heat through the casing. The magnetic adjustment principle of the hybrid excitation motor with the structure, the design characteristics of the winding yoke and stator teeth, and the factors influencing the adjustment

Manuscript received August 23, 2021; revised November 05, 2021; accepted January 06, 2022. date of publication June 25, 2022; date of current version June 18, 2022.

This work has been supported by the National Natural Science Foundation of China (51907129); Project Supported by department of education of Liaoning Province (LQGD2019006). (*Corresponding Author: Wenming Tong*)

Shengnan Wu is with the School of Electrical Engineering, Shenyang University of Technology, Shenyang 110870, China (e-mail: imwushengnan@163.com).

Yukun Wang is with the School of Electrical Engineering, Shenyang University of Technology, Shenyang 110870, China.(e-mail:wangyukun4396@163.com).

Wenming Tong is with the National Engineering Research Center for Rare Earth Permanent Magnet Machines, Shenyang University of Technology, Shenyang 110870, China. (e-mail: twm822@126.com).

Digital Object Identifier 10.30941/CESTEMS.2022.00025

capability are studied, and the 3D-FEM is used to verify the working principle.

II. THE STRUCTURE AND PRINCIPLE OF A NEW MODULAR STATOR HYBRID EXCITATION MOTOR

A. Motor Topology

The structure of the new modular stator hybrid excitation motor proposed in this paper is shown in Fig. 1. This is a 4-pole 6-slot concentrated winding motor. From the outside to the inside, the stator yoke is wound by amorphous alloy, and the stator teeth are laminated by amorphous alloy. The electric field winding is divided into two sections along the axial direction and wound on the stator teeth, and the armature winding is wound on the stator teeth. The rotor magnetic pole adopts a surface-mounted structure, the permanent magnetic poles and the iron core poles are arranged alternately, and the rotor iron core adopts a solid structure.

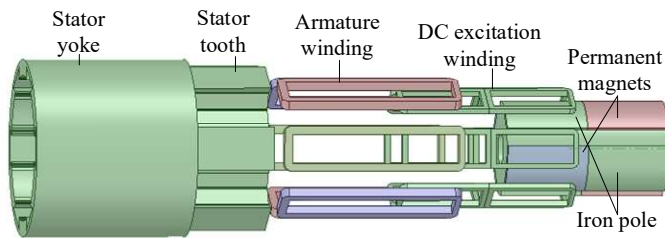

Fig. 1. Novel hybrid excitation motor.

When the armature winding adopts the concentrated winding, the end is shorter, which not only saves the copper consumption but also improves the efficiency. The electric field winding is divided into two sections along the axial direction and the current direction is opposite. Both the armature winding and the electric field winding are located on the stator side, eliminating the need for slip rings and brushes, improving the reliability of the motor. There is only radial magnetic circuit on the iron core pole, so the use of silicon steel sheets to replace the solid iron core pole in the axial direction can effectively block the eddy current path, reduce loss and improve efficiency. The rotor core adopts a solid structure to provide a 3D magnetic flux path.

The yoke of the hybrid excitation motor studied in this paper has axial and circumferential magnetic flux path. The traditional axial laminated stator will block the axial magnetic flux path. Combining the characteristics of amorphous alloy strips suitable for winding, the stator yoke adopts a winding structure. The stator teeth have only radial magnetic flux, so the axial laminated structure can ensure the smooth flow of the magnetic circuit. The stator yoke and the stator teeth are fixedly connected by dovetail slots, and the manufacturing process is shown in Fig. 2. The stator yoke and the stator teeth are processed separately, so that the armature winding and the electric field winding can be wound on the stator teeth first, and then the stator teeth around the winding can be embedded in the stator yoke. With this structure, the slot opening can be greatly reduced and cogging harmonics can be weakened.

B. Magnetic Flux Path and Principle of Magnetic Modulation

There are three working states of hybrid excitation motors: only permanent magnet working state, magnetizing state, and

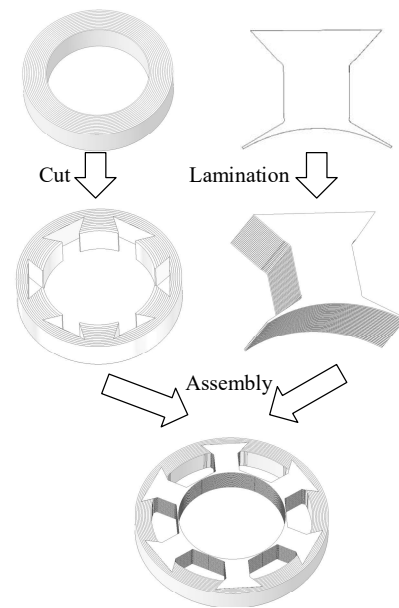

Fig. 2. Manufacturing and installation process of winding yoke and lamination teeth.

demagnetizing state. When the electric excitation current is 0A, only the permanent magnet acts alone. At this time, the magnetic flux path is the permanent magnet N pole, air gap, stator teeth, circumferential stator yoke, axial stator yoke, circumferential stator yoke, stator tooth, Air gap, permanent magnet S pole, rotor yoke. The electric field winding is divided into two sections in the axial direction. The first half corresponds to the S pole of the permanent magnetic pole, and the second half corresponds to the N pole. The magnetomotive force direction of the two is opposite. When the electric field windings work as magnetizing state, the principle is shown in Fig. 3(a). The magnetomotive force of the electric field winding in the front half of the axial direction is radially outward, magnetizing the iron core pole adjacent to the N pole in the axial direction. At this time, the iron core is equivalent to permanent magnet 'N pole'. Similarly, the iron core poles of the permanent magnet S pole axially adjacent to each other are equivalent to the permanent magnet 'S pole'. At this time, the magnetic flux under each pole is enhanced, and the magnetization is enhanced. Fig. 3(b) shows that when the electric excitation current works as demagnetizing state, the iron core pole axially adjacent to the N pole of the permanent magnet is equivalent to the permanent magnet 'S pole', and the iron core pole axially adjacent to the permanent magnet S pole is equivalent to the permanent magnet 'N pole'. The total flux under each pole decreases, and the magnetization weakening can be realized.

In order to further clarify the principle of magnetization, Fig. 4 shows a cross-sectional view of the motor, drawing the magnetic flux path of the electric excitation.

III. DESIGN AND ANALYSIS

A 4-pole 6-slot hybrid excitation motor of this structure was designed to verify the principle. The main parameters are shown in Table I.

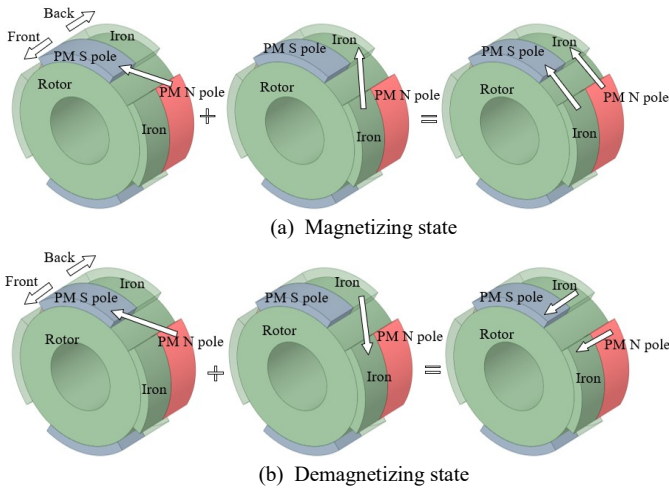

Fig.3. Schematic diagram of magnetizing and demagnetizing state.

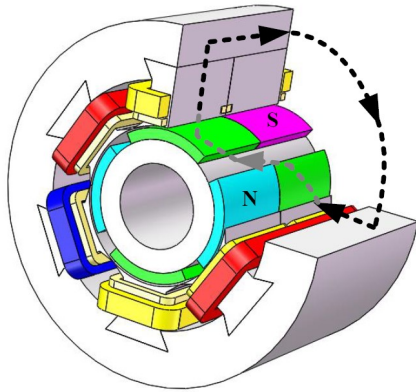

Fig.4. DC excitation flux path.

A. Verification of Motor Parameters and Principle of Magnetization

TABLE I
PARAMETERS OF MOTOR

Parameter	Value	Parameter	Value
Rated speed n /rpm	3000	Axial length L /mm	120
Rated power P_N /kW	1.0	Stator tooth width w /mm	16
Rated Voltage U_N /V	380	Permanent magnet thickness h_m /mm	4
Stator outer diameter D_1 /mm	130	Permanent magnet pole arc coefficient α_p	0.8
Stator inner diameter D_2 /mm	72	Axial length of permanent magnet l_m /mm	60

The magnetic flux path of the new modular hybrid excitation synchronous motor in this paper is special and has obvious 3D-FEM characteristics. The two-dimensional finite element method is no longer applicable [11]. This paper uses the 3-D finite element method to calculate the electromagnetic performance of the motor. The air gap flux density distribution under different electric excitation conditions is shown in Fig. 4.

From the simulation results in Fig. 4(a), it shows that the air gap magnetic density can be found at the permanent magnetic poles when there is no electric excitation current. The air gap

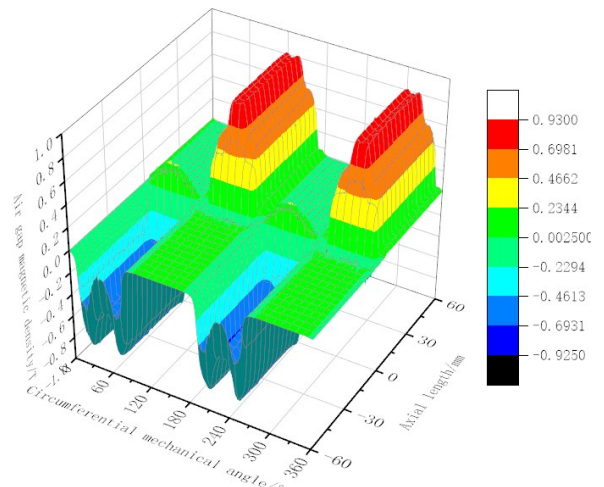

(a) Air gap magnetic density cloud map when there is no electric excitation.

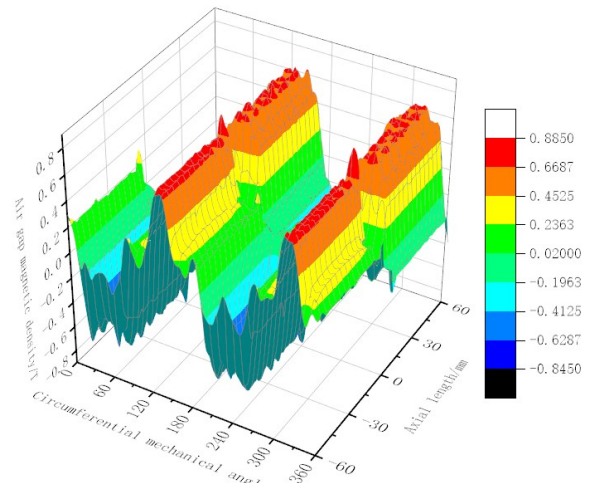

(b) Cloud map of air gap magnetic density in magnet enhancement statement.

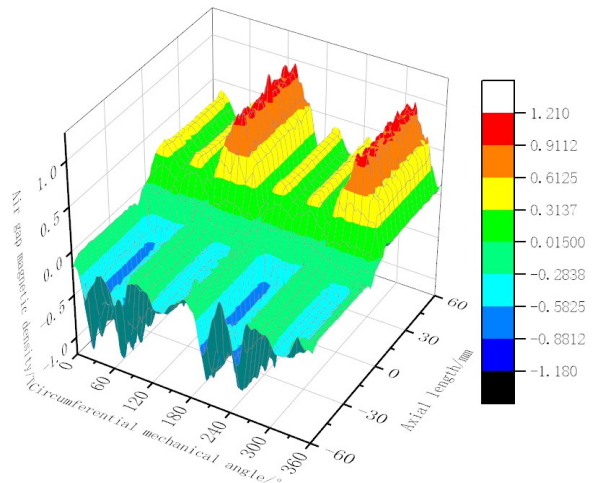

(c) Air gap magnetic density cloud map in flux weakened statement.

Fig.5. Air gap magnetic density under different excitation currents.

magnetic density is close to 0T at iron poles. It is verified that the theoretical analysis of the magnetic flux path when only the permanent magnet acts, that is, the magnetic flux of the N pole of the permanent magnet passes through the air gap, the stator, and returns to the S pole of the permanent magnet arranged in staggered manner.

The air gap flux density distribution in the state of magnetizing is shown in Fig. 4(b). The difference is that the air gap at the poles of the iron core also has a flux density distribution, which affects the original magnetic field of each pole. Because the motor adopts the staggered magnetic pole arrangement, it divides the rotor into two parts in the axial direction. The stator can also be considered in the same way. The magnetic flux generated by the electric field winding and the permanent magnet magnetic flux pass through the axial front and rear parts of the teeth separately, avoiding the saturation of the amorphous iron core in the state of maximum magnetization. Even if you continue to increase the current of the electric excitation winding, the magnetization efficiency will decrease rapidly when the amorphous alloy core is saturated. The separation of the permanent magnet flux path and the electric excitation flux path in stator tooth can avoid the iron core saturation caused by the traditional armature winding magnetization.

The demagnetizing state of electric excitation is shown in Fig. 4(c), which is opposite to the state of magnetization. At this time, the air gap magnetic density at the core pole is opposite to the axially adjacent permanent magnetic pole, weakening the magnetic flux of each pole, so that the motor has a strong field weakening ability to expand the range of speed.

B. Modular Stator Design

Because the magnetic circuit of the hybrid excitation motor has 3D characteristics, the stator needs to be able to conduct flux paths. Therefore, the stator uses laminated teeth to provide radial magnetic flux, and the winding yoke provides axial and circumferential magnetic circuits, eliminates the heavy magnetic backs of similar staggered magnetic pole hybrid excitation motors and reduces the size of the motor. The structure after the dovetail groove is embedded and fixed is shown in Fig. 6.

As shown in Fig. 6, the stator yoke is a wound amorphous alloy. In order to facilitate the demonstration of the principle, the interlayer gap of the winding yoke in the schematic diagram is enlarged and the winding yoke is divided into red and blue parts in the radial direction. The blue part of the winding yoke height h_1 is in contact with the stator teeth, and the magnetic flux from the stator teeth can directly enter. The red part of the winding yoke is high h_2 , and it is not in contact with the stator teeth, so the magnet flux will be blocked. That is, the yoke with a height of h_1 is the main magnetic flux path of the yoke, the

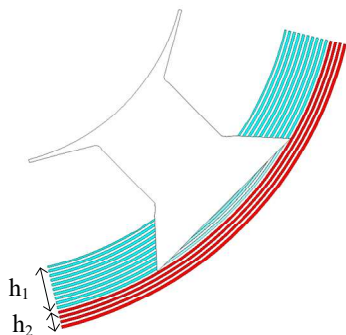

Fig. 6. Schematic diagram of layered yoke.

yoke with a height of h_2 is for structural strength. When designing the depth of the stator tooth embedded in the stator yoke, it should be embedded as deeply as possible under the premise of meeting the structural strength.

This analysis is verified by 3D-FEM electromagnetic field simulation. It is worth noting that the yoke adopts a winding method, so when assigning material properties in Maxwell, it should be set to the radial stacking direction of the cylindrical coordinate system. After the simulation, the field calculator is used for post-processing, and the magnetic density of the red and blue winding yokes are respectively divided by area, and then the magnetic permeability of the two yokes is compared. The post-processing model is shown in Fig. 7. The area where the magnetic density needs to be integrated is marked with two colors. The simulation cloud diagram of the magnetic density of the yoke is shown in Fig. 8. It can be seen from the cloud diagram that the magnetic density of the outer yoke is much lower than that of the inner stator yoke. Use the field calculator to post-process the magnetic flux calculation data of the yoke as shown in Table 2. The result shows that the magnetic flux per unit height of the high blue yoke is 9.41 times that of the red yoke. It can be concluded that the blue yoke directly in contact with the stator teeth is the main magnetic flux path. The effective height must be noticed in the design process. Considering the influence of the installation depth on the structural strength, the thickness ratio of the inner and outer yokes selected in this paper is 1:3.

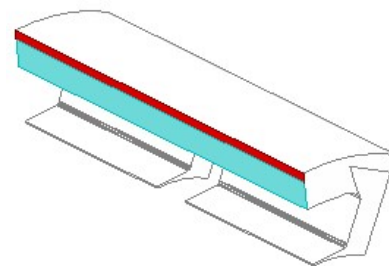

Fig. 7. Layer post-processing model of yoke part.

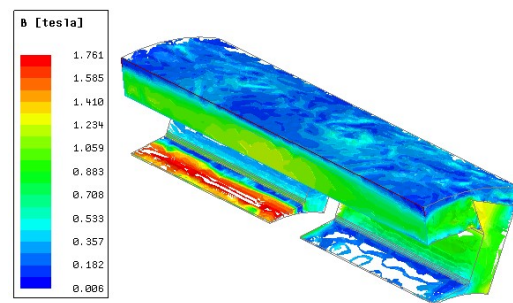

Fig. 8. Simulated magnetic density cloud of yoke.

TABLE II
COMPARISON OF MAGNETIC PERMEABILITY OF TWO-LAYER WINDING YOKE

Calculation area	Yoke of height h_1	Yoke of height h_2
Yoke height h/mm	8.43	2.90

Flux Φ / Wb	6.10×10^{-4}	2.23×10^{-5}
Flux per Height $\Phi / (\text{Wb}/\text{mm})$	7.24×10^{-5}	7.69×10^{-6}

IV. 3-D FINITE ELEMENT ANALYSIS

A. Research on the Influencing Factors of Magnetic Modulation Ability

The essence of the electric field winding to adjust the magnetic field is to change the algebraic sum of the air gap magnetic flux. The following part will derive the factors that affect the ability to adjust the magnetism.

The magnetic flux at the air gap is composed of two parts, the magnetic flux provided by the permanent magnet and the magnetic flux provided by the electric excitation.

$$\phi = \phi_{\text{pm}} + \phi_{\text{DC}} \quad (1)$$

Where: ϕ is the total magnetic flux of the air gap; ϕ_{pm} is the magnetic flux provided for the permanent magnet; ϕ_{DC} is the magnetic flux provided for the electric field winding [12]-[13].

The magnetic flux provided by the permanent magnet can be expressed as:

$$\phi_{\text{pm}} = B_r \cdot S \quad (2)$$

Where: B_r is the magnetic density of the permanent magnet in no-load operating point; S is the surface area of the magnetic pole.

When it is not saturated, the magnetic permeability of the core material is much higher than that of the air. Now assuming that the core material is not saturated, the magnetic resistance of the electric excitation circuit is approximated by the air gap magnetic resistance. The magnetic flux provided by electric excitation can be expressed as:

$$\phi_{\text{DC}} = \frac{F}{R_{\delta}} = \frac{NI_{\text{DC}}}{\delta} = \frac{NI_{\text{DC}}\mu_0 S}{\delta} \quad (3)$$

Where: ϕ_{DC} is the magnetic flux provided by the electric excitation; F is the electric excitation magneto motive force; R_{δ} is the electric excitation air gap reluctance; N is the number of electric excitation turns; I_{DC} is the electric excitation current; δ is the air gap length; μ_0 is the vacuum permeability.

The ratio of the magnetic flux provided by the electric excitation to the magnetic flux provided by the permanent magnet reflects the magnetization ability.

$$\frac{\phi_{\text{DC}}}{\phi_{\text{pm}}} = \frac{NI_{\text{DC}}\mu_0}{B_r \cdot \delta} \quad (4)$$

It can be seen from formula (4) that the magnetizing ability is directly proportional to the number of electric excitation turns and current, but there is a certain limit to increase the electric excitation current. Excessive electric density will cause the electric excitation copper loss to rise rapidly, and the motor temperature rise is too high. From the point of view of the air gap length, reducing the air gap can improve the magnetization

capability, but it will make the rotor eddy current loss caused by higher harmonics obvious.

B. Simulation of Magnetic Tuning Ability

Take the A-phase flux linkage when only permanent magnets are acting as the reference, compare the A-phase flux linkage standard unit value ψ^* under different electric excitation currents to reflect the magnetic field adjustment ratio.

It can be seen from the simulation results of Fig. 9 that when the electric excitation current is 0A, the phase flux linkage unit value ψ^* is 1. When the electric excitation current is in the state of magnetizing and the current is 4A, the phase flux linkage is increased by 39.9% compared to when only the permanent magnet acts. When the electric excitation current is in the demagnetizing state and field current is -4A, the phase flux linkage is reduced 28.2%. The electric excitation magnetizing ability is better than the electric excitation demagnetizing ability, and the effect of increasing the torque at low speed is excellent.

The length of the air gap is very important to the influence of the magnetic adjustment capability. The simulation results are shown in Fig. 10. As the air gap length increases, the magnetic tuning capability gradually weakens. Taking the air gap length of 1mm and 2mm as an example, the maximum magnetization difference is 11%.

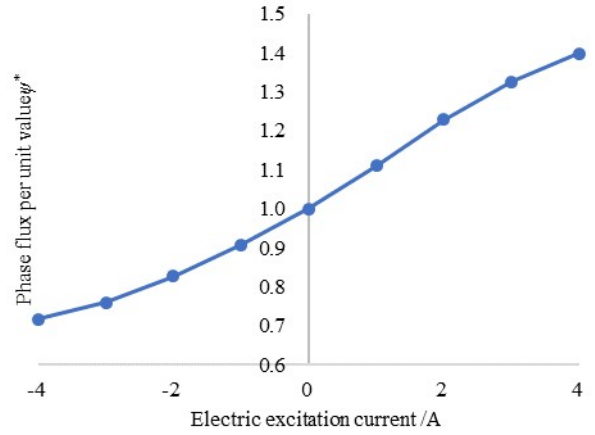

Fig. 9. Magnetic field adjustment ratio.

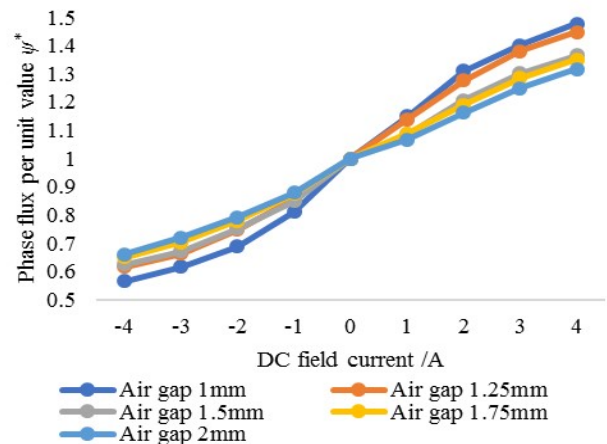

Fig. 10. Influence of the air gap length on flux adjustment.

C. Simulation of Magnetic Adjustment Ability

Wide speed regulating motor can eliminate the need for traditional motor and variable speed gearbox combinations for speed regulation through direct frequency conversion and speed regulation, and improve the efficiency of the system. However, when the motor is lower than the rated speed, it maintains a constant torque, and the power is small. The hybrid excitation motor can solve this problem by increasing the magnetization at low speed. The electromagnetic torque of the hybrid excitation motor with id=0 control can be expressed as:

$$T_e = \frac{3}{2} p i_q (\psi_m + M_{sf} i_f) \tag{5}$$

Where: T_e is the electromagnetic torque; p is the number of permanent magnet pole pairs; ψ_m is the permanent magnet flux linkage; M_{sf} is the mutual inductance between the d-axis winding and the electric excitation winding; i_f is the electric excitation current; i_q is the armature current of q-axis [14].

When the motor design is completed, M_{sf} is a certain value, and the electromagnetic torque can be increased by increasing the excitation current i_f , and the flux adjustment is flexible. The results of the 3D-FEM simulation are shown in Fig. 11. The electromagnetic torque of the motor increases approximately linearly with the increase of the electric excitation current. The torque is increased by 37.66% during the maximum electric excitation.

The torque of the traditional surface mount permanent magnet synchronous motor running below the rated speed is

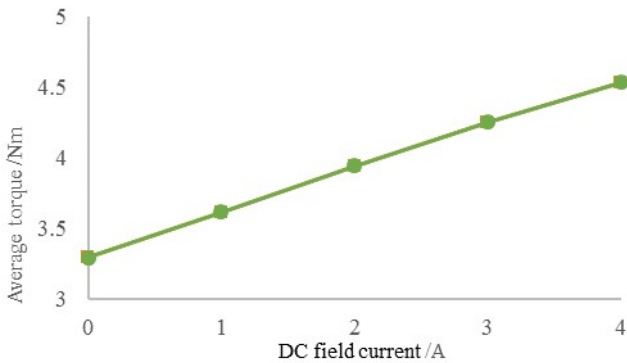

Fig. 11. Torque lifting capacity at low speed.

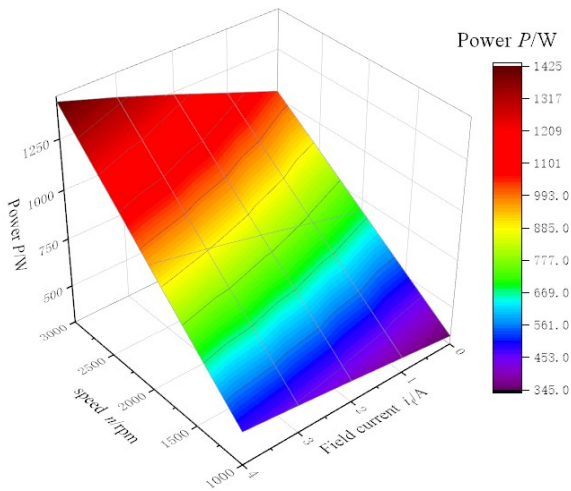

Fig. 12. Power at low speed under different DC excitation current

a constant value, and as the speed increases, the output power increases linearly. The new modular hybrid excitation motor proposed in this paper can increase the output power by increasing the magnetization at low speeds. The simulation result is shown in Fig. 12. The output power increases with the increase in speed, and at the same time, the output power can be continuously increased by increasing the electric excitation current i_f . When the speed is 1000 rpm and field current change from 0A to 4A, the output power increased from 345W to 475W. When the speed is 2000 rpm, the output power increased from 690W to 950W. It can be seen that the power improvement effect at low speed is excellent.

V. CONCLUSION

In this paper, a new material amorphous alloy is used and a new stator structure is innovatively proposed and designed a 1kW, 3000rpm new modular stator hybrid excitation motor. The motor has a good magnetic field adjustment ability and low iron consumption. Compared with DW270 electrical silicon steel sheet, the use of amorphous alloy materials in this motor can reduce iron consumption by 70%. After theoretical analysis and 3D-FEM simulation verification, the following conclusions are drawn:

- 1) This paper innovatively proposes a new structure hybrid excitation motor. The hybrid excitation motor with modular stator structure and staggered magnetic pole rotor structure has the characteristics of convenient installation, direct magnetization method, good magnetization effect, and high reliability.
- 2) The combined structure of the amorphous alloy winding stator yoke and laminated stator teeth can provide a 3D magnetic flux path, which is consistent with the theoretical analysis, and only the inner winding yoke provides the main magnetic flux paths. On the basis of meeting the structural strength, the stator teeth are suggested to deeply embed in the winding yoke.
- 3) The new modular hybrid excitation motor proposed in this paper can enhance the magnetization by 39.9% and weaken the field by 28.2%, and the magnetization capacity is better than the demagnetization capacity by 11.7%, and the magnetization effect is good.
- 4) The motor can increase the output torque by 37.66% by increasing the electric field winding current at low speed, output more power.

REFERENCES

- [1] ZHU Xiaoyong, CHENG Ming, ZHAO Wenxiang, et al. "An overview of hybrid excited electric machine capable of field control". *Transactions of China Electrotechnical Society*, vol. 23, no.1, pp.30-39, Jan. 2008.
- [2] ZHANG Zhuoran, WANG Dong, and HUA Wei. "Overview of Configuration, Design and Control Technology of Hybrid Excitation Machines". *Transactions of China Electrotechnical Society*, vol. 40, no.24, pp.7834-7850, Dec. 2020.
- [3] ZHANG Zhuoran, ZHOU Jingjie, AN Yangguang, et al. "Construction and operation principle of a novel coordinate structure hybrid excitation synchronous machine". *Proceedings of the CSEE*, vol.29, no.33, pp.83-89, Nov. 2009.
- [4] WANG Shiyong, LIU Xu, DONG Danyang, et al. "Optimisation and comparison of flux adjustment capability in hybrid excited switching flux

permanent magnet machines". *Small & Special Electrical Machines*, vol. 47, no.5, pp.6-11, May. 2019.

- [5] LIU Xu, WANG Shiyong, WANG Jianfei, et al. "Influence investigation of rotor pole numbers on flux adjustment capability in hybrid excited switched flux permanent magnet machines". *Electric Machines and Control*, vol. 24, no.10, pp.19-26, Dec. 2020.
- [6] Kun Liu, "Optimization design and performance research of Biaxial Excitation Generator/ Motor for Automobiles," Ph.D. dissertation, Dept. Elect., Nanchang Univ, Nanchang, China, 2014.
- [7] J. U. Duncombe, "Infrared navigation—Part I: An assessment of feasibility," *IEEE Trans. Electron Devices*, vol. ED-11, no. 1, pp. 34–39, Jan. 1959.
- [8] JING Libing, GAO Qixing, WANG Chong, et al. "Optimization design and characteristic analysis of dual-rotor hybrid excitation motor". *Electric Machines and Control*, vol. 23, no. 9, pp.43-53, Sept. 2019.
- [9] Z. Li, Y. Li, X. Li. "Flux control of a CPPM machine for both a wide speed range and high efficiency". *Transactions on Power Electronics*, vol. 29, no. 9, pp. 4866-4876, Sept. 2014.
- [10] Tapia J A, Leonardi F, Lipo T A. "Consequent-pole permanent-magnet machine with extended field-weakening capability". *IEEE Transactions on Industry Applications*, vol. 39, no. 6, pp. 1704-1709, Nov. 2003.
- [11] Fan T, Li Q, Wen X. "Development of a High Power Density Motor Made of Amorphous Alloy Cores". *IEEE Transactions on Industrial Electronics*, vol. 61, no. 9, pp. 4510-4518, Sept. 2014.
- [12] ZHANG Zongsheng, WANG Xiuhe, YANG Yubo. "Modeling and analysis of single-phase parallel hybrid excitation flux switching motor". *Electric Machines and Control*, vol. 19, no. 3, pp.1-7, Dec. 2015.
- [13] LIU Xiping, DIAO Yanmei, ZUO Liangping. "Optimization of stator-separated axial flux-switching hybrid excitation machine". *Electric Machines and Control*, vol. 17, no. 12, pp.70-75, Dec. 2013.
- [14] Aydin M, Huang S, Lipo T A. "Design, analysis, and control of a hybrid field-controlled axial-flux permanent magnet motor". *IEEE Transactions on Industrial Electronics*, vol. 51, no.1, pp.78-87, 2010.
- [15] ZHAO Chaohui, QIN Haihong, YAN Yangguang. "Present status and application perspective of hybrid excitation synchronous machine". *Electric Machines and Control*, no. 2, pp.113-117, Mar. 2006.



Shengnan Wu (M'18) was born in Yingkou, China. She received the B.S., M.S., and Ph.D. degrees in electrical engineering from the Shenyang University of Technology, Shenyang, China, in 2008, 2011, and 2017, respectively.

She is currently a Postdoctoral Research Assistant in electrical engineering with Shenyang University of Technology. Her research interests include electromagnetic design and multiphysical field simulation and analysis of permanent magnet machines.



Yukun Wang was born in Dalian, China. He received the B.S. degree in electrical engineering from Shenyang University of Technology, Shenyang, China, in 2015. He is currently pursuing the M.S. degree in electrical engineering with the Shenyang University of Technology, Shenyang, China, in 2019. His main research interests include analysis and design hybrid excitation permanent magnet synchronous machines.



Wenming Tong (M'18) was born in Dandong, China. He received the B.S. and Ph.D. degrees in electrical engineering from the Shenyang University of Technology, Shenyang, China, in 2007 and 2012, respectively.

He is currently an Associate Professor with the National Engineering Research Center for Rare Earth Permanent Magnet Machines, Shenyang University of Technology. His major research interests include the design, analysis, and control of high-speed and low-speed direct drive permanent magnet machines, axial flux permanent magnet machines, hybrid excitation machines, and high-performance machines with new types of soft magnetic materials.