

Robust Multiobjective and Multidisciplinary Design Optimization of Electrical Drive Systems

Gang Lei, Tianshi Wang, Jianguo Zhu, and Youguang Guo

Abstract—Design and optimization of electrical drive systems often involve simultaneous consideration of multiple objectives that usually contradict to each other and multiple disciplines that normally coupled to each other. This paper aims to present efficient system-level multiobjective optimization methods for the multidisciplinary design optimization of electrical drive systems. From the perspective of quality control, deterministic and robust approaches will be investigated for the development of the optimization models for the proposed methods. Meanwhile, two approximation methods, Kriging model and Taylor expansion are employed to decrease the computation/simulation cost. To illustrate the advantages of the proposed methods, a drive system with a permanent magnet synchronous motor driven by a field oriented control system is investigated. Deterministic and robust Pareto optimal solutions are presented and compared in terms of several steady-state and dynamic performances (like average torque and speed overshoot) of the drive system. The robust multiobjective optimization method can produce optimal Pareto solutions with high manufacturing quality for the drive system.

Index Terms—Electrical drive systems, electrical machines, multidisciplinary design optimization, multiobjective optimization, robust design optimization.

I. INTRODUCTION

ELECTRICAL machines and drive systems are the crucial components in many appliances and industrial systems like electric vehicles. Their analysis and design optimization processes become more and more complex and challenging as more disciplines (like electromagnetics, structural mechanics, heat transfer and control), constraints/objectives are involved, such as maximizing torque/power and efficiency, minimizing the material cost, volume, cogging torque and torque ripple of the motor. These objectives usually contradict to each other like material cost and average torque. These disciplines are normally strong coupled and coupled field analysis is always required, such as electromagnetic-thermal analysis and electromagnetic- structural analysis [1-6].

To achieve multiobjective optimal performance of electrical drive systems for applications of challenging specifications, such as electric vehicles and wind power generation, it is of

great significance to take a systematic multidisciplinary design analysis and optimization. Thus, multiobjective and multidisciplinary analysis and design optimization is a critical and challenging research topic in this field [1, 2].

Regarding the multiobjective optimization of electrical drive systems, there are only a few studies. The common practice is on the motor itself, without much consideration on the control and power electronics. However, these design optimization methods are on component level, i.e. motor level, rather than on system level as the control schemes have not been optimized. Therefore, the system's performance, especially the dynamic performances cannot be ensured [7-9].

On the other hand, the final performance of produced electrical machines and systems highly depends on the practical material diversities (especially for the magnetic materials) and manufacturing tolerances. To decrease the sensitivity of these uncertainties and their effects on the performance, robust design optimization should be investigated in the early design stage of drive systems [1, 2, 3, 10-13]. These uncertainties have not considered in the deterministic approach of design optimization. Thus, the performance and manufacturing quality of the produced motors cannot be ensured by conventional deterministic design optimization approach. Currently, not much work has been reported [1], [2].

To solve these two issues, deterministic and robust approaches have been investigated for the system-level single-objective design optimization of electrical drive systems, and promising results have been obtained [1-4]. The main aim of this work is to investigate efficient multiobjective and multidisciplinary optimization methods for drive systems. Besides the optimization model like deterministic and robust approaches, the optimization efficiency is another critical issue. To deal with this issue, two kinds of approximate techniques will be presented for this purpose in this work.

This paper aims to present efficient robust multiobjective and multidisciplinary design optimization methods for drive systems. Section II introduces the general multidisciplinary design analysis and optimization frameworks for drive systems. Section III presents the multiobjective optimization models for drive systems in terms of deterministic and robust approaches to consider multidisciplinary design specifications and constraints. Section IV introduces two approximate techniques, Kriging model and Taylor expansion to improve the efficiency of the multiobjective and robust optimization. Sections V and VI present the details including optimization models and results

Manuscript was submitted for review on 24 April, 2018.

G. Lei, T. Wang, and Y. Guo are with the School of Electrical and Data Engineering, University of Technology Sydney, Sydney, 2007, Australia (e-mail: gang.lei@uts.edu.au).

J. Zhu is with the School of Electrical and Information Engineering, The University of Sydney, Australia (e-mail: jianguo.zhu@sydney.edu.au).

Digital Object Identifier 10.30941/CESTEMS.2018.00052

comparison for an application of the proposed methods on a drive system, followed by the conclusion.

II. MULTIDISCIPLINARY DESIGN OPTIMIZATION FRAMEWORK

Fig. 1 shows a general multidisciplinary design framework for an electrical drive system with considerations of different components and disciplines, such as electromagnetics, heat transfer, power electronics and control system [1-3].

Fig. 2 shows a framework with more details for the multidisciplinary design and optimization of a drive system. As shown, the whole process consists of five steps. Firstly, define the requirements and specifications of the complete drive system, such as rated torque and power, and maximal given space. Secondly, design or select the types of motor, drive and controllers for the expected drive system. For example, there are several popular motor types for the application as drive machines in the (hybrid) electric vehicles, such as permanent magnet (PM) synchronous motors, induction machines and switched reluctance motor [14,15]. For each type, there are also several topologies like different rotor/stator poles. For another example, for the control system and strategies, popular ones include field oriented control (FOC) and direct torque control [1, 16-18]. Recently, model predictive control (MPC) has become a promising one for high efficiency control. Fig. 3 shows a block diagram for the typical MPC schemes [1-3]. As shown, there are several control parameters which need to optimize, such as PI factors and the parameters in the cost function. Thirdly, design the analysis models for all components of the systems, such as FEA model for motor and simulation model for the controller [19-24]. Fourthly, define the optimization models for the whole system and each component, including optimization objectives, constraints and parameters, and implement the optimization to gain the optimization results finally, evaluate the steady and dynamic performances for the obtained optimal design schemes [3].

III. ROBUST MULTIOBJECTIVE OPTIMIZATION MODELS

As shown in Fig. 2, there are many design parameters (including motor design parameters and control parameters), objectives and constraints in the step 4, such as optimizing the motor efficiency, average torque or torque density, minimizing the volume, weight, cost, loss and torque ripple. Therefore, the optimization is normally a multiobjective optimization problem with a model as

$$\begin{aligned} \min : & \{f_i(\mathbf{x}), i = 1, \dots, p\} \\ \text{s.t.} & \quad g_j(\mathbf{x}) \leq 0, \quad j = 1, \dots, m, \\ & \quad \mathbf{x}_l \leq \mathbf{x} \leq \mathbf{x}_u \end{aligned} \quad (1)$$

where p and m are the numbers of the objectives $f(\mathbf{x})$ and constraints $g(\mathbf{x})$, respectively, \mathbf{x}_l and \mathbf{x}_u are the boundaries of \mathbf{x} . Mathematically, model (1) is a deterministic model as it does not involve any noise factors for all design parameters and performances.

However, there are many uncertainties in the practical manufacturing of motors and their drive systems such as

material diversities of PMs and manufacturing errors of motor dimensions. They can be regarded as the noise factors for drive systems as they have a big impact on the motor performance in mass production [1-3].

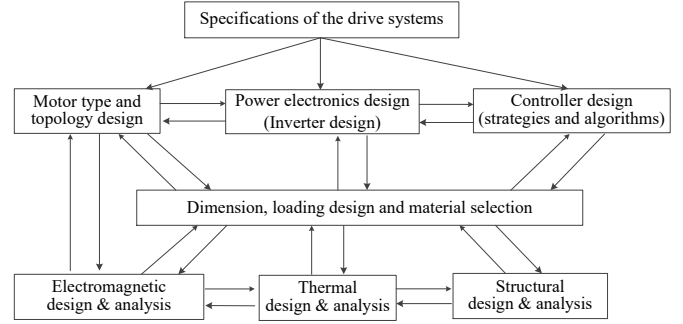

Fig. 1. Multi-disciplinary design framework of an electrical drive system.

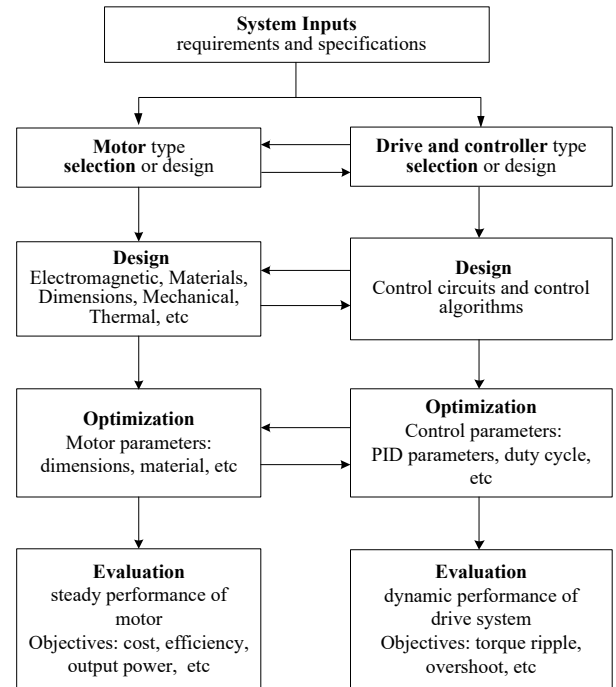

Fig. 2. Design and optimization framework for an electrical drive system.

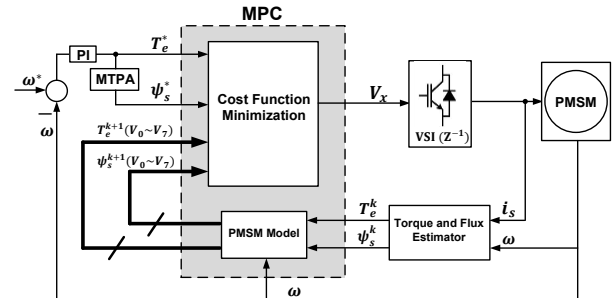

Fig. 3. Block diagram of a typical MPC scheme for a PMSM drive.

Therefore, due to these variations, all the design parameters and performance functions should be taken as variables, which will lead to the concept of uncertainty optimization. Many uncertainty optimization methods have been developed for industrial robust designs [25-28]. A robust approach called the

design for Six Sigma (DFSS) will be investigated in this work [29-32]. Under the framework of this robust approach, the robust multiobjective optimization model of (1) can be defined as

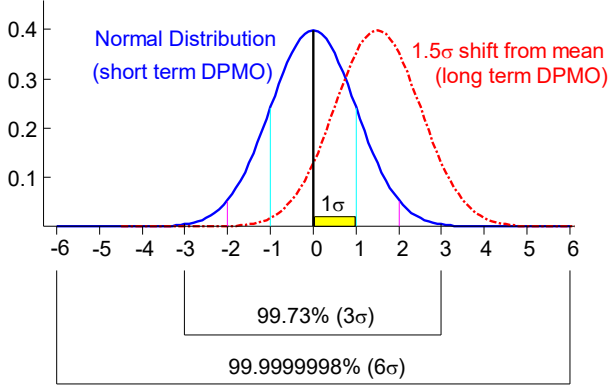

Fig. 4. Sigma level and its equivalent reliability for quality control.

$$\begin{aligned} \min : & \{F_i(\mu_{f_i}(\mathbf{x}), \sigma_{f_i}(\mathbf{x})), i = 1, \dots, p\} \\ \text{s.t.} & \begin{cases} g_j(\mu_f(\mathbf{x}), \sigma_f(\mathbf{x})) \leq 0, j = 1, \dots, m \\ \mathbf{x}_l + n\sigma_x \leq \mu_x \leq \mathbf{x}_u - n\sigma_x \\ \text{LSL} \leq \mu_f \pm n\sigma_f \leq \text{USL} \end{cases}, \quad (2) \end{aligned}$$

where μ stands for the mean, σ is the standard deviation, n the sigma level, USL and LSL are specification limits. In Statistics, this sigma level can be converted to a reliability as shown in Fig. 4, which is also equivalent to the “short-term sigma quality” in the quality control field. For example, 3σ quality means a reliability of 99.73%, equivalent to 2700 defects per million opportunities (DPMO). However, in the long-term quality control, there is an approximate shift of 1.5σ for the mean. This shift will lead 3σ quality to 66,803 DPMO, a high defect rate. Hence, 6σ level has been accepted by industry as its equivalent DPMO is only 3.4 [3].

Finally, a probability of failure (POF) of an optimized drive system can be calculated by the following equation.

$$\text{POF} = 1 - \prod_{i=1}^m P(g_i \leq 0) \quad (3)$$

where $P(g_i \leq 0)$ can be estimated by using the Monte Carlo method. This POF can be used to compare the reliabilities of the optimized drive systems given by different methods [3].

IV. TWO APPROXIMATION TECHNIQUES

For the solving of (1) and (2), an efficient multiobjective optimization algorithm is needed. There are many options nowadays like multiobjective particle swarm optimization algorithm, non-dominated sorting genetic algorithm (NSGA) and NSGA II [1, 33]. However, the computation costs of optimizing mode (1) and (2) are extremely huge due to three main reasons. First, finite element analysis (FEA) is usually included for the motor’s design which generally needs huge computation cost, especially for some 3D flux permanent

magnet (PM) machines with complex structures. Second, the Monte Carlo analysis (MCA) in the robust optimization, such as the estimation of manufacturing reliability and quality parameters, usually needs extra huge computational cost. Third, drive systems are always high-dimensional nonlinear multidisciplinary problems, which are challenges for optimization [1, 2]. To deal with these problems, two approximate techniques, Kriging model and Taylor expansion are introduced as follows.

Kriging model is a kind of surrogate models, similar to the response surface model (RSM), radial basis function model. They can be employed to reduce the computation cost of finite element model (FEM) [1, 34-36]. The response of Kriging model consists of two parts, a deterministic term $y_0(\mathbf{x})$ and a random error term $z(\mathbf{x})$. It has the form as

$$y(\mathbf{x}) = y_0(\mathbf{x}) + z(\mathbf{x}), \quad (4)$$

where $y_0(\mathbf{x})$ may be a first order or second order RSM, $z(\mathbf{x})$ is a random variable vector with mean zero, variance σ^2 and covariance matrix $[c_{ij}]$ as

$$c_{ij} = \sigma^2 \mathbf{R}[R(\mathbf{x}_i, \mathbf{x}_j)], \quad (5)$$

where R is a user-defined correlation function and \mathbf{R} is the correlation matrix. Kriging is superior to RSM and radial basis function model due to its strong modeling ability of local nonlinearities [1].

Secondly, to reduce the computation cost of the evaluation of robust parameters, Taylor series approximate method will be used in this work. Generally, Monte Carlo method is used to estimate the mean and standard deviation terms in (2). However, its computational cost is very large. For example, if 10^4 random samples are used in MCA to estimate these robust parameters of means and standard deviations in (2), 10^4 extra FEA sample points and 10^4 simulation points in the control circuit also need to be evaluated. Therefore, the extra computation cost will be increased greatly, so an alternative method is needed. Taylor approximate method is a good choice as the magnitude of noise terms is very small [37]. The second-order expansion will be investigated in this work.

Neglecting higher order terms, the second order Taylor’s expansion for a function or response $y(\mathbf{x})$ has the form as

$$y(\mathbf{x}) = y_0 + \frac{dy}{d\mathbf{x}} \Delta \mathbf{x} + \frac{1}{2} \Delta \mathbf{x}^T \frac{d^2 y}{d\mathbf{x}^2} \Delta \mathbf{x}. \quad (6)$$

Taking mathematical expectation on both sides, the mean of this response can be calculated by

$$\mu_y = y(\mu_x) + \frac{1}{2} \sum_{i=1}^D \frac{d^2 y}{dx_i^2} \sigma_{x_i}^2. \quad (7)$$

Then, with a similar process, the standard deviation of the response can be computed as

$$\sigma_y^2 = \sum_{i=1}^D \left(\frac{\partial y}{\partial x_i} \right)^2 \sigma_{x_i}^2 + \frac{1}{2} \sum_{i=1}^D \sum_{j=1}^D \left(\frac{\partial^2 y}{\partial x_i \partial x_j} \right)^2 \sigma_{x_i}^2 \sigma_{x_j}^2, \quad (8)$$

where D is the dimension of \mathbf{x} . With (7) and (8), only $(D+1)$ $(D+2)/2$ samples are needed for the simulation of control system, and a lot of computation cost can be saved. For example, for a drive system with 10 design parameters, only 66 points are needed to evaluate the robust parameters; and this is much smaller than that in MCA as which needs 10^4 points.

V. A DRIVE SYSTEM AND ITS OPTIMIZATION MODELS

Figs. 5-7 show components of a drive system with a PM transverse flux machine (TFM) driven by the FOC scheme. Fig. 5 illustrates the PM rotor soft magnetic composite (SMC) stator of a prototype designed in the previous work. The rated speed, torque and output power of this PM TFM are 1800 rev/min, 3.40 Nm and 640 W, respectively. Table I lists several dimensional parameters for this motor [1, 38, 39].

For the performance evaluation of this machine, 3D FEA model is required, as shown in Fig. 6. Table I lists seven design parameters to be investigated in the following multiobjective optimization process. They are significant to the motor performance based on our previous studies. To drive this motor, an FOC control scheme as shown in Fig. 7 is employed, where $\omega_{\text{ref}}=1800$ r/min and $I_{d\text{ref}}=0$. For the control part, the values of the PI (x_8 and x_9) are the optimization parameters. The conventional deterministic multiobjective optimization model of this drive system can be defined as

$$\begin{aligned} \min : & \begin{cases} f_1(\mathbf{x}) = \text{Cost}(\text{PM}) + \text{Cost}(\text{Cu}) \\ f_2(\mathbf{x}) = -T \end{cases} \\ \text{s.t.} : & \begin{cases} g_1(\mathbf{x}) = 0.795 - \eta \leq 0, \\ g_2(\mathbf{x}) = 640 - P_{\text{out}} \leq 0, \\ g_3(\mathbf{x}) = sf - 0.8 \leq 0, \\ g_4(\mathbf{x}) = J_c - 6 \leq 0, \\ g_5(\mathbf{x}) = \text{RMSE}(T_e) - 0.06 \leq 0, \\ g_6(\mathbf{x}) = \text{RMSE}(\omega_e) - 0.03 \leq 0 \end{cases}, \end{aligned} \quad (9)$$

where f_1 is the material cost of PM and copper (Cu) winding, f_2 the average torque, η motor efficiency, P_{out} (unit: W) the output power, sf the slot filling factor, J_c (unit: A/mm²) the current density in the winding, T_e the relative error of torque (T), ω_e the relative error of speed (ω), T and ω are responses dynamically output by the drive system. RMSE in the constraints stands for the root mean square error.

With the structure of DFSS as shown in (2), the robust multiobjective and multidisciplinary optimization model of this drive system can be defined as

$$\begin{aligned} \min : & \begin{cases} F_1 = \mu_{f_1}(\mathbf{x}) \\ F_2 = \mu_{f_2}(\mathbf{x}) \end{cases} \\ \text{s.t.} : & \begin{cases} \mu_{g_i}(\mathbf{x}) + n\sigma_{g_i}(\mathbf{x}) \leq 0, \quad i = 1, \dots, 6 \\ x_{li} + n\sigma_{x_i} \leq \mu_{x_i} \leq x_{ui} - n\sigma_{x_i}, \quad i = 1, \dots, 7 \\ x_{li} \leq x_i \leq x_{ui}, \quad i = 8, 9 \end{cases}, \end{aligned} \quad (10)$$

It should be noted that only the motor design parameters are variables as control parameters are digital real numbers. In the

implementation, standard deviation of each parameter is defined as 1/3 of its manufacturing tolerance [30].

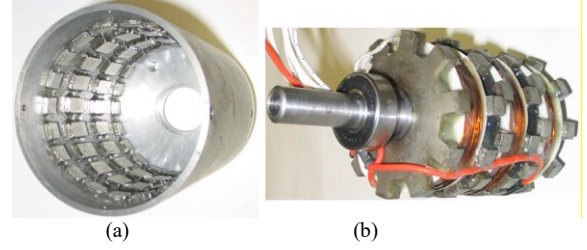

Fig. 5. Prototype of a TFM, (a) PM rotor, (b) 3 stack SMC stator.

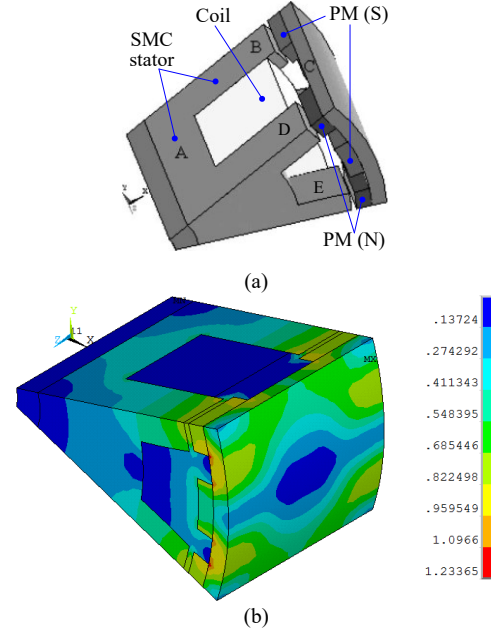

Fig. 6. (a) One pole pitch for FEA, and (b) magnetic field distribution under no-load situation.

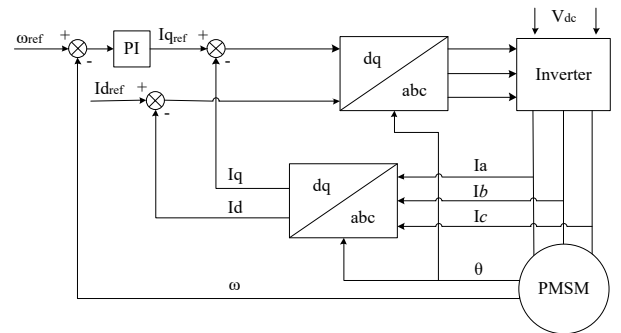

Fig. 7. FOC scheme for the PM TFM.

TABLE I
MAIN DESIGN PARAMETERS OF PM-SMC TFM

Par.	Description	Unit	Value
x_1	PM circumferential angle	degree	12
x_2	PM width	mm	9
x_3	SMC tooth circumferential	mm	9
x_4	SMC tooth axial width	mm	8
x_5	Air gap length	mm	1.0
x_6	Number of turns	turns	125
x_7	Diameter of copper wire	mm	1.25

VI. RESULTS AND DISCUSSIONS

Figs. 8-14 show the performance comparison of the motors for the optimal design scheme given by deterministic and robust multiobjective approaches. After comparison, the following conclusions can be drawn.

1) Fig. 8 shows the Pareto optimal solutions of the investigated drive system obtained from two models, deterministic multiobjective optimization model (9) and robust model (10). As shown, the Pareto front of the robust approach is obviously lower than that of the deterministic approach. It means that the deterministic approach can provide a motor with higher torque for the same material cost.

Meanwhile, the objectives of all deterministic and robust Pareto designs are better than those of the initial design. For the initial design, the output torque in the steady-state is 3.40 Nm and the motor material cost of PM and winging is \$34.0. For all designs given by deterministic approach, the minimal torque is 3.41 Nm, but the required material cost for this design is \$25.1, which is much lower than that of initial design. For all designs given by robust approach, the minimal torque is 3.50 Nm, slightly larger than that of initial and deterministic designs. Similarly, the required material cost for this design is \$26.6, slightly higher than that of deterministic design but much lower than that of initial design as well. Thus, motor performances have been improved greatly after multiobjective optimization.

2) Fig. 9 shows the POF values of all optimal Pareto points given in the Fig. 8 for both design approaches. As shown, the POF values of robust optimal designs are almost 0, while the POF values of the deterministic optimal designs are unstable and many are higher than 20%. These are not good designs from the perspective of manufacturing.

3) After reviewing the POF values and sigma levels for each constraint, it is found that the POF values of the constraints g_4 , g_5 and g_6 mainly account for the system's POF. Fig. 10 illustrates the POF values and sigma levels of them for both the optimal design schemes. As shown in Fig. 10(a), the POF values of g_6 are all smaller than 0.2, while the values of g_4 and g_5 are very high and unstable. And as shown in Fig. 10(b), the sigma levels of some Pareto points are less than 2 for these three constraints, far away from the six-sigma quality. Thus, the better Pareto solutions given by deterministic approach as shown in Fig. 8 is obtained by the cost of the higher POF values and lower sigma levels. For robust approach, the sigma levels of all constraints are no less than 6. Thus, robust approach can improve the reliability (smaller POF values) and robustness (higher sigma levels) for the studied drive system.

4) To show more details for the POF values, Figs. 11-14 show the mean and standard deviation (STD) curves of the current density, torque RMSE, motor efficiency and output power for all Pareto points obtained from both approaches.

For the constraint of the current density, as shown in Fig. 11, all the means and standard deviations of Pareto points gained from robust approach are obviously smaller than those from deterministic approach. For the deterministic approach, many MCA samples are higher than the limit of 6 A/mm².

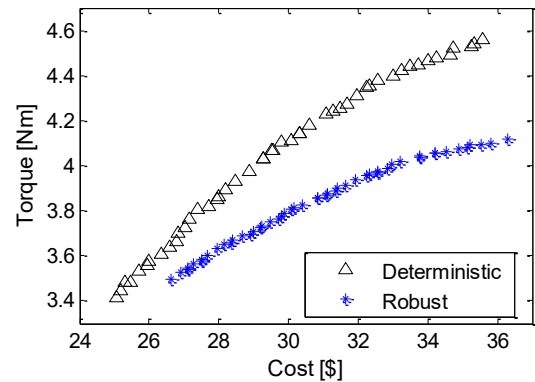

Fig. 8. Pareto optimal solutions for the drive system given by both methods.

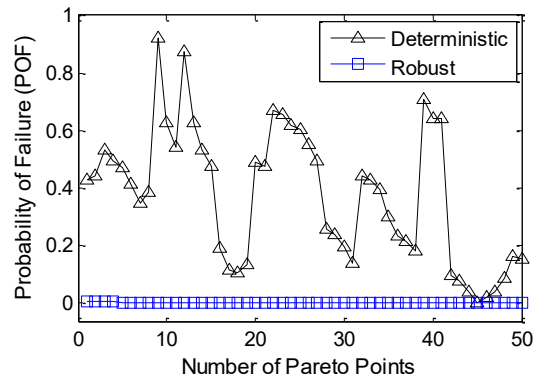

Fig. 9. POF values for all optimal Pareto points given by both methods.

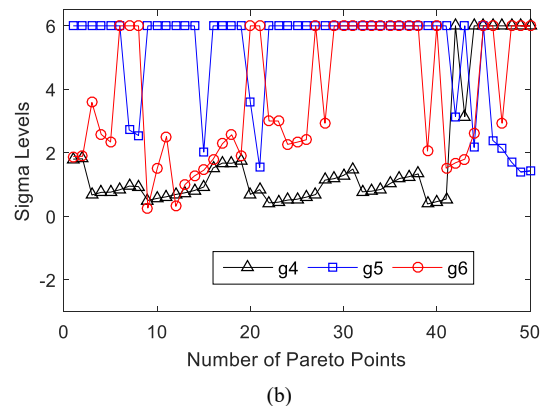
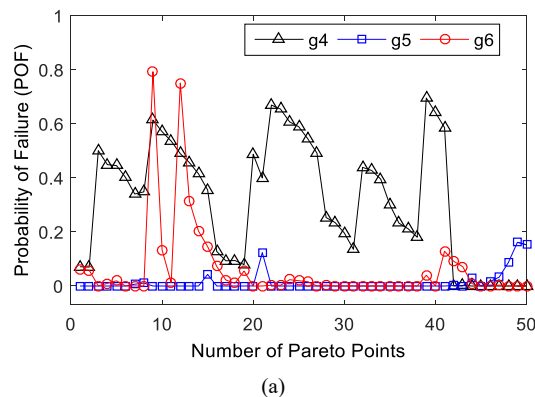
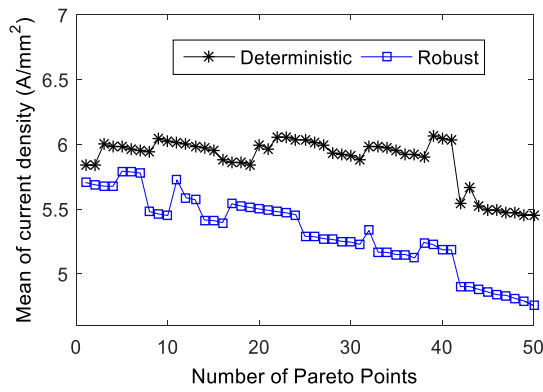
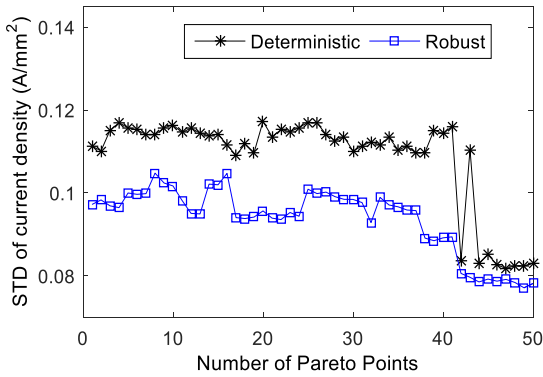

Fig. 10. POF values (a) and sigma levels (b) of g_4 , g_5 and g_6 for deterministic Pareto points.



(a)



(b)

Fig. 11. Mean (a) and standard deviation (b) of current density for all Pareto points.

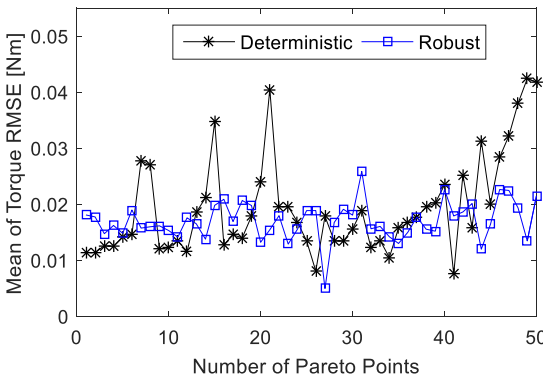

(a)

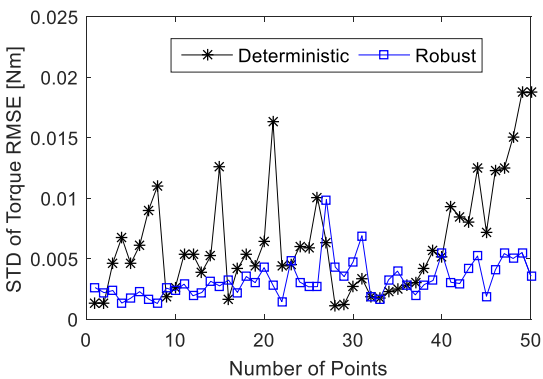

(b)

Fig. 12. Mean (a) and standard deviation (b) of torque RMSE for all Pareto points

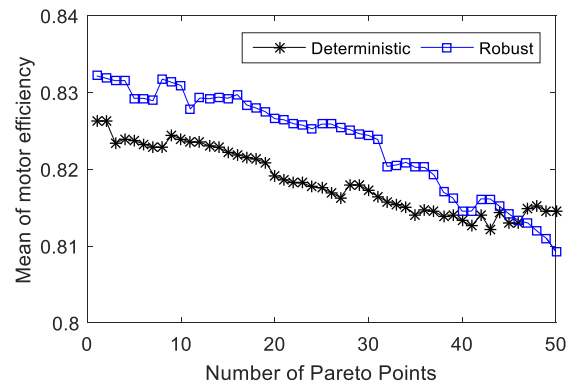

(a)

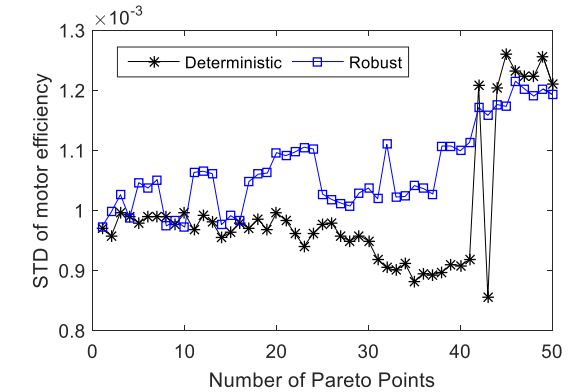

(b)

Fig. 13. Mean (a) and standard deviation (b) of motor efficiency for all Pareto points.

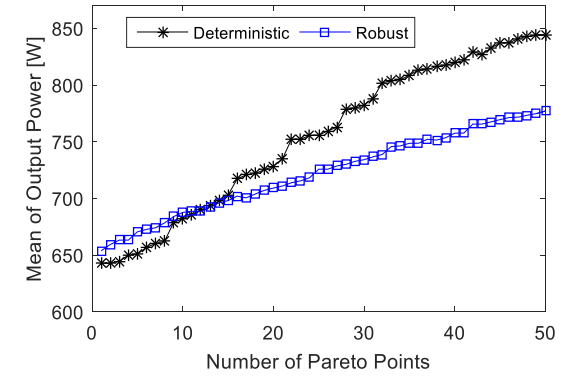

(a)

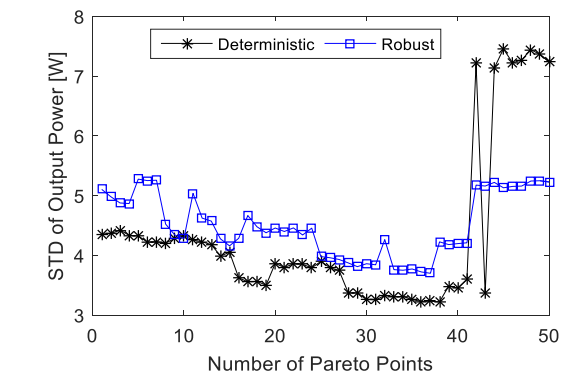

(b)

Fig. 14. Mean (a) and standard deviation (b) of motor output power for all Pareto points

TABLE II
MEAN OF THE CONSTRAINTS

Constrains	Deterministic		Robust	
	μ	σ	μ	σ
η	0.818	0.001	0.826	0.001
P_{out}	754.32	4.39	722.10	4.46
J_c	5.88	0.11	5.32	0.09
RMSE(T_c)	0.019	0.006	0.017	0.003
RMSE(ω_c)	0.005	0.0125	0.001	0.0001

For the constraint of the torque RMSE, as shown in Fig. 12, robust approach can provide some Pareto points with less means and standard deviations, but not all the points. However, the averages of the means and standard deviations of robust approach are 17 and 3 mNm respectively, which are smaller than those of the deterministic approach (19 and 6 mNm).

For the motor efficiency, as shown in Fig. 13(a), the robust approach can provide motor design schemes with higher efficiency, except the last four Pareto points with high material cost (around \$35 as shown in Fig. 8). Moreover, the boundary of the motor efficiency is 79.5% as defined in (9), which is much smaller than those given by multiobjective optimization as shown in Fig. 13, so the POF of this constraint is almost 0 for both design approach. For the output power, as shown in Fig. 14(a), the deterministic approach can provide motor design schemes with higher output power, except the first 13 Pareto points with low material cost (as shown in Fig. 8).

5) Table II lists the averages of all means and standard deviations of each constraint. As shown, except the second one, robust approach provides electrical drives with smaller standard deviations, meaning higher quality in manufacturing.

VII. CONCLUSION

In this work, multiobjective optimization was presented for the robust multidisciplinary design of drive systems. An efficient system-level robust multiobjective and multidisciplinary design optimization model was obtained based on the DFSS technique. Both the motor dimensions and the control parameters were investigated for system-level performance optimization. Two approximation techniques, Kriging model and Taylor series were employed to reduce the computational costs of FEA in motor, simulation effort in control system and the robust parameters in DFSS. Based on a case study, it was found that the reliabilities gained from the robust multiobjective approach are better. Therefore, robust multiobjective and multidisciplinary design optimization benefits the performance and manufacturing quality of electrical drive systems.

REFERENCES

- [1] Gang Lei, Jianguo Zhu, and Youguang Guo, *Multidisciplinary Design Optimization Methods for Electrical Machines and Drive Systems*, Springer-Verlag Berlin Heidelberg, 2016.
- [2] G. Lei, J. Zhu, Y. Guo, C. Liu and B. Ma, "A review of design optimization methods for electrical machines", *Energies*, vol. 10, no. 12, Art. no. 1962, pp. 1-31, 2017.
- [3] G. Lei, T. S. Wang, J. G. Zhu, *et al.*, "System level design optimization methods for electrical drive systems: robust approach," *IEEE Trans. Ind. Electron.*, vol. 62, no. 8, pp.4702-4713, 2015.
- [4] G. Lei, T. S. Wang, Y. G. Guo, *et al.*, "System level design optimization methods for electrical drive systems: deterministic approach," *IEEE Trans. Ind. Electron.*, vol. 61, no. 12, pp. 6591-6602, 2014.
- [5] G. Lei, C. C. Liu, J. G. Zhu, and Y. G. Guo, "Multidisciplinary design analysis and optimization of a PM transverse flux machine with soft magnetic composite core," *IEEE Trans. Magn.*, vol. 51, no. 11, 2015.
- [6] X. Zhu, Z. Xiang, C. Zhang, *et al.*, "Co-reduction of torque ripple for outer rotor flux-switching PM motor using systematic multi-level design and control schemes," *IEEE Trans. Ind. Electron.*, vol. 64, no. 2, pp. 1102-1112, 2017.
- [7] X. Zhu, Z. Shu, L. Quan, Z. Xiang and X. Pan, "Multi-objective optimization of an outer-rotor V-shaped permanent magnet flux switching motor based on multi-level design method," *IEEE Trans. Magn.*, vol. 52, no. 10, pp. 1-8, 2016.
- [8] F. Dong, J. Song, J. Zhao and J. Zhao, "Multi-objective design optimisation for PMSLM by FITM," *IET Electric Power Applications*, vol. 12, no. 2, pp. 188-194, 2018.
- [9] M. Ashabani and Y. A.-R. I. Mohamed, "Multiobjective shape optimization of segmented pole permanent-magnet synchronous machines with improved torque characteristics," *IEEE Trans. Magn.*, vol. 47, no. 4, pp. 795-804, 2011.
- [10] C. T. Krasopoulos, M. E. Beniakar and A. G. Kladas, "Robust optimization of high-speed PM motor design," *IEEE Trans. Magn.*, vol. 53, no. 6, 2017.
- [11] G. Bramerdorfer and A.-C. Zăvoianu, "Surrogate-based multi-objective optimization of electrical machine designs facilitating tolerance analysis," *IEEE Trans. Magn.*, vol. 53, no. 8, 2017.
- [12] J.-G. Lee, N.-W. Hwang, H.-R. Ryu, H.-K. Jung, and D.-K. Woo, "Robust optimization approach applied to permanent magnet synchronous motor," *IEEE Trans. Magn.*, vol. 53, no. 6, 2017.
- [13] J. Song, F. Dong, J. Zhao, *et al.*, "Optimal design of permanent magnet linear synchronous motors based on Taguchi method," *IET Electr. Power Appl.*, vol. 11, no. 1, pp. 41-48, 1 2017.
- [14] X. D. Sun, Y. C. Shen, *et al.*, "Core losses analysis of a novel 16/10 segmented rotor switched reluctance BSG motor for HEVs using nonlinear lumped parameter equivalent circuit model," *IEEE/ASME Transactions on Mechatronics*, vol. 23, no. 2, pp. 747-757, 2018.
- [15] X. Zhu, Z. Shu, L. Quan, Z. Xiang and X. Pan, "Design and multicondition comparison of two outer-rotor flux-switching permanent-magnet motors for in-wheel traction applications," *IEEE Trans. Ind. Electron.*, vol. 64, no. 8, pp. 6137-6148, 2017.
- [16] X. D. Sun, L. Chen, Z. B. Yang, H. Q. Zhu, "Speed-sensorless vector control of a bearingless induction motor with artificial neural network inverse speed observer," *IEEE/ASME Transactions on Mechatronics*, vol. 18, no. 4, pp. 1357-1366, 2013.
- [17] X. D. Sun, L. Chen, *et al.*, "High-performance control for a bearingless permanent magnet synchronous motor using neural network inverse scheme plus internal model controllers," *IEEE Trans. Ind. Electron.*, vol. 63, no. 6, pp. 3479-3488, 2016.
- [18] X. D. Sun, Z. Shi, L. Chen, and Z. B. Yang, "Internal model control for a bearingless permanent magnet synchronous motor based on inverse system method," *IEEE Trans. Energy Convers.*, vol. 31, no. 4., pp. 1539-1548, 2016.
- [19] X. Zhu, Z. Xiang, L. Quan, W. Wu and Y. Du, "Multimode optimization design methodology for a flux-controllable stator permanent magnet memory motor considering driving cycles," *IEEE Trans. Ind. Electron.*, vol. 65, no. 7, pp. 5353-5366, 2018.
- [20] Z. Xiang, X. Zhu, L. Quan, Y. Du, C. Zhang, D. Fan, "Multilevel design optimization and operation of a brushless double mechanical port flux-switching permanent-magnet motor," *IEEE Trans. Ind. Electron.*, vol. 63, no. 10, pp. 6042-6054, 2016.
- [21] Y. Wang, S. Niu and W. Fu, "Sensitivity analysis and optimal design of a dual mechanical port bidirectional flux-modulated machine," *IEEE Trans. Ind. Electron.*, vol. 65, no. 1, pp. 211-220, 2018.
- [22] X. Liu, W. N. Fu and S. Niu, "Optimal structure design of permanent magnet motors based on a general pattern of rotor topologies," *IEEE*

Trans. Magn., vol. 53, no. 11, pp. 1-4, 2017.

- [23] B. Ma, G. Lei, J. Zhu and Y. Guo, "Design optimization of a permanent magnet claw pole motor with soft magnetic composite cores," *IEEE Trans. Magn.*, vol. 54, no. 3, Art. no. 8102204, 2018.
- [24] B. Ma, G. Lei, C. Liu, J. Zhu and Y. Guo, "Robust tolerance design optimization of a PM claw pole motor with soft magnetic composite cores," *IEEE Trans. Magn.*, vol. 54, no. 3, Art. no. 8102404, 2018.
- [25] G. Sun, H. Zhang, J. Fang, G. Li, Q. Li, "Multi-objective and multi-case reliability-based design optimization for tailor rolled blank structures," *Struct. Multidiscip. Optim.*, vol. 55, no. 5, pp. 1899-1916, 2017.
- [26] X. Gu, G. Sun, G. Li, L. Mao, Q. Li, "A comparative study on multiobjective reliable and robust optimization for crashworthiness design of vehicle structure," *Struct. Multidiscip. Optim.*, vol. 48, no. 3, pp. 669-684, 2013.
- [27] G. Sun, G. Li, S. Zhou, H. Li, S. Hou, Q. Li, "Crashworthiness design of vehicle by using multiobjective robust optimization," *Struct. Multidiscip. Optim.*, vol. 44, no. 1, pp. 99-110, 2011.
- [28] G. Sun, H. Zhang, J. Fang, G. Li, Q. Li, "A new multi-objective discrete robust optimization algorithm for engineering design," *Applied Mathematical Modelling*, vol. 53, pp. 602-621, 2018.
- [29] G. Lei, C. C. Liu, J. G. Zhu, and Y. G. Guo, "Robust multidisciplinary design optimization of PM machines with soft magnetic composite cores for batch production," *IEEE Trans. Magn.*, vol. 52, no. 3, 2016.
- [30] B. Ma, G. Lei, J. Zhu, Y. Guo and C. Liu, "Application-oriented robust design optimization method for batch production of permanent-magnet motors," *IEEE Trans. Ind. Electron.*, vol. 65, no. 2, pp. 1728-1739, 2018.
- [31] G. Lei, J. G. Zhu, Y. G. Guo, J. F. Hu, W. Xu and K. R. Shao, "Robust design optimization of PM-SMC motors for Six Sigma quality manufacturing," *IEEE Trans. Magn.*, vol. 49, no. 7, pp. 3953-3956, 2013.
- [32] G. Lei, J. G. Zhu, Y. G. Guo, K. R. Shao and W. Xu, "Multi-objective sequential design optimization of PM-SMC motors for Six Sigma quality manufacturing," *IEEE Trans. Magn.*, vol. 50, no. 2, 2014.
- [33] K. Deb, A. Pratap, S. Agarwal, and T. Meyarivan, "A fast and elitist multi-objective genetic algorithm: NSGA-II," *IEEE Trans. Evol. Comput.*, vol. 6, no. 2, pp. 182-197, 2002.
- [34] G. Lei, C. C. Liu, J. G. Zhu, and Y. G. Guo, "Techniques for multilevel design optimization of permanent magnet motors," *IEEE Transactions on Energy Conversion*, vol. 30, no. 4, pp. 1574-1584, 2015.
- [35] G. Lei, J. G. Zhu, Y. G. Guo, Wei Xu and K. R. Shao, "Multi-objective sequential optimization method for the design of industrial electromagnetic devices," *IEEE Trans. Magn.*, vol. 48, no. 11, pp. 4538-4541, 2012.
- [36] G. Lei, C. C. Liu, J. G. Zhu, and Y. G. Guo, "Multilevel robust design optimization of a superconducting magnetic energy storage based on a benchmark study," *IEEE Transactions on Applied Superconductivity*, vol. 26, no. 7, Oct. 2016, Art. no. 5701405.
- [37] P. N. Koch, R. J. Yang, and L. Gu. "Design for six sigma through robust optimization," *Struct. Multidiscip. Optim.*, vol. 26, no. 3-4, pp. 235-248, 2004.
- [38] C. C. Li, G. Lei, T. S. Wang, Y. G. Guo, Y. H. Wang, J. G. Zhu, "Comparative study of small electrical machines with soft magnetic composite cores," *IEEE Trans. Ind. Electron.*, vol. 64, no. 2, pp. 1049-1060, 2017.
- [39] C. C. Liu, J. G. Zhu, Y. H. Wang, and Y. G. Guo, G. Lei, "Comparison of claw pole machines with different rotor structures," *IEEE Trans. Magn.*, vol. 51, no. 11, Art. no. 8110904, 2015.



Gang Lei (M'14) received the B.S. degree in Mathematics from Huanggang Normal University, China, in 2003, the M.S. degree in Mathematics and Ph.D. degree in Electrical Engineering from Huazhong University of Science and Technology, China, in 2006 and 2009, respectively.

He is currently a lecturer at the School of Electrical and Data Engineering, University of Technology

Sydney (UTS), Australia. His current research interests include electrical machines and systems, multidisciplinary design optimization, industrial big data and cloud computing techniques.



Tianshi Wang received the B.E. degree from Harbin Institute of Technology, China, in 2008 and the M.E. degree from University of Technology Sydney (UTS), Sydney, Australia, in 2013.

He is currently a Ph.D. candidate of School of Electrical and Data Engineering, University of Technology Sydney (UTS). His research interests include sensorless

and high-performance control of ac motor drives, optimal pulse width modulation and advanced digital control with real time implementation.



Jianguo Zhu (S'93-M'96-SM'03) received the B.E. degree from Jiangsu Institute of Technology, China, in 1982, the M.E. degree from Shanghai University of Technology, China, in 1987, and the Ph.D. degree from the University of Technology, Sydney (UTS), Australia, in 1995, all in electrical engineering.

He is currently a professor of Electrical Engineering at the University of Sydney, Australia. His research interests include electromagnetics, magnetic properties of materials, electrical machines and drives, power electronics, and green energy systems.



Youguang Guo (S'02-M'05-SM'06) received the B.E. degree from Huazhong University of Science and Technology, China in 1985, the M.E. degree from Zhejiang University, China in 1988, and the Ph.D. degree from University of Technology, Sydney (UTS), Australia in 2004, all in electrical engineering.

He is currently an associate professor at the School of Electrical and Data Engineering, UTS. His research fields include measurement and modeling of properties of magnetic materials, numerical analysis of electromagnetic field, electrical machine design optimization, power electronic drives and control.