

# Vehicle Identification by Means of Radio-Frequency-Identification Cards and Magnetic Loops

Ferran Mocholí Belenguer<sup>1</sup>, Antonio Martínez-Millana, Antonio Mocholí Salcedo, and José Humberto Arroyo Núñez

**Abstract**—At present, many detectors installed on both urban and interurban roads are capable of extracting information from vehicles such as speed, length or direction of traffic. However, very few sensors are currently able to communicate and exchange information with vehicles in real time. For this reason and due to the existing need for vehicle-infrastructure communication in Intelligent Transportation Systems (ITS), this paper proposes the use of Radio-Frequency-Identification cards together with the magnetic loops already in operation on the road to extract and exchange information about different vehicles through bidirectional communication. This usage will lead to many applications. Therefore, different RFID cards and their operating mode and the electrical circuits necessary for accurate system operation will be presented and analyzed.

**Index Terms**—Communications, infrastructure, loops, magnetic, RFID, sensor, vehicle.

## I. INTRODUCTION

THE transformation of transport is a reality. New technologies applied to the automotive industry, big data and shared economy are changing the way people approach the world of transport. These advances, which are expected to contribute to an increase in the vehicle fleet together with world population growth, will soon result in unsustainable traffic in the main cities if actions are not taken [1]. For this reason, the need for greater control over vehicles is increasing considerably; this increase is why the extraction of information, identification and classification of vehicles in real time has emerged as a priority since the introduction of Intelligent Transportation Systems (ITS) [2].

Manuscript received March 26, 2019; revised August 6, 2019 and October 7, 2019; accepted October 15, 2019. Date of publication November 11, 2019; date of current version November 30, 2020. This work was supported by the Universitat Politècnica de València through its internal project ‘Equipos de detección, regulación e información en el sector de los sistemas inteligentes de transporte (ITS). Nuevos modelos y ensayos de compatibilidad y verificación de funcionamiento’, which has been carried out at the ITACA Institute. The Associate Editor for this article was G. Mao. (Corresponding author: Ferran Mocholí Belenguer.)

F. Mocholí Belenguer is with the Traffic Control Systems Group, ITACA Institute, Universitat Politècnica de València, 46022 Valencia, Spain (e-mail: fermocbe@upv.es).

A. Martínez-Millana is with the SABIEN Group, ITACA Institute, Universitat Politècnica de València, 46022 Valencia, Spain (e-mail: anmarmil@itaca.upv.es).

A. Mocholí Salcedo is with the Department of Electronic Engineering, ITACA Institute, Universitat Politècnica de València, 46022 Valencia, Spain (e-mail: amocholi@eln.upv.es).

J. H. Arroyo Núñez is with the Electronic and Telecommunications Engineering Department, Universidad Politécnica de Tulancingo, Tulancingo 43629, México (e-mail: humberto.arroyo@upt.edu.mx).

Digital Object Identifier 10.1109/TITS.2019.2948221

All of these trends imply continuous installation and improvement of the current road infrastructure, which is currently being redefined. As recently as a few years ago, road infrastructure was limited to physical components such as barriers, traffic lights and regulators. However, future road infrastructure will need to include components such as wireless networks, artificial intelligence and new sensor prototypes in order to adapt to the current technological changes. Moreover, as roads cover a large proportion of the earth’s surface, especially within cities, the large number of emerging technologies are expected to turn this element, now passive, into something much more productive [3]–[5].

Due to their simplicity and operating mode, magnetic loops are the most used traffic sensors in ITS [6]–[8]. They are a widely extended and well-known reliable technology that offers good performance at low cost. Proof of this is that despite being introduced in the 1960’s, magnetic loops are still the main elements of the newest algorithms for traffic management in cities [9]–[11].

In the very near future, these sensors should also be able to obtain vehicle-specific data separately such as the car number plate and exchange information. For this reason, the use of RFID cards together with the induction loops already installed is proposed as a solution to the challenge.

The operating mode would be truly simple since there would only be two elements: the magnetic loops already buried in the road [6] and RFID cards [12], which should be installed in the lower part of the vehicle. Using this method, when a vehicle passes over a loop, the RFID card would emit a signal that would be received by the loop reader system or the other way around. Moreover, the cost of RFID cards is negligible and there would not any additional cost for the installation of loops since they are already in operation worldwide. Consequently, the implementation of the whole system would be very affordable.

This identification and information exchange in real time between vehicles and infrastructure could lead to a very large number of interesting applications that would help both manage traffic more efficiently and improve road quality and safety. Some examples are detailed below:

- Location of priority vehicles such as ambulances, fire trucks or police cars: traffic lights could be synchronized from the traffic control room when necessary and thus, facilitate their free circulation.

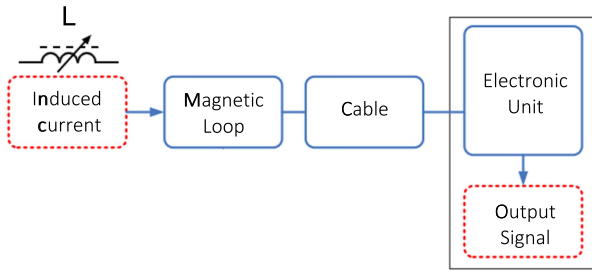

Fig. 1. Magnetic loop system scheme.

- Location of stolen vehicles: the RFID card could be activated when a vehicle is robbed in order to detect where the vehicle is circulating.
- Access control: bollards could be activated in urban environments depending on the type of vehicle for pollution control or anti-terrorism purposes.
- Information providers: an innovative entertainment option would be to take advantage of car screens so that when entering a town, city or country, a magnetic loop previously installed at the entrance of a location with information about the location would transmit that information to the RFID card. In this way, this information could be displayed on the car screen to show information including the weather, number of inhabitants or tourist sites.

Therefore, we are very confident that this proposal could become a powerful tool capable of improving the services provided by the centers responsible for regulating traffic and the quality of road infrastructure. In fact, this has proven to be a flexible and economic system with a large number of interesting applications.

In this context, this paper will present an in-depth study of this type of system and its application in urban environments and has been divided into three general blocks:

- Magnetic Profile Detection Systems
- RFID Systems
- Proposed System and Pilot Field Trials

## II. MAGNETIC PROFILE DETECTION SYSTEM

The steady increase in traffic and the current proliferation of electric vehicles in cities is generating a need to implement electronic devices to detect and control their circulation and, as a result, make roads a safer place. Currently, there are several devices installed around the world for this purpose [13]. However, our proposal will focus on the use of magnetic loops, an intrusive sensor found in a large number of urban and interurban areas capable of determining the type, speed, and length of a vehicle [14]–[16].

The operation of the system is straightforward since magnetic loops are based on the inductance variation that is recorded as a vehicle passes over. Moreover, as shown in Fig. 1 and 2, an entire system usually only consists of three simple blocks [7]:

- A magnetic loop formed by a wire with one or more turns superficially buried in the pavement.
- A cable that links the magnetic loop with the control booth, which is also buried in the pavement.

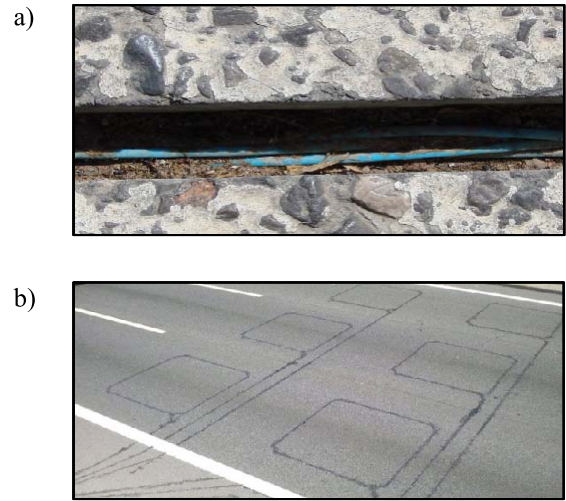

Fig. 2. (a) Detail of the conductor in the groove. (b) Magnetic loops after being buried.

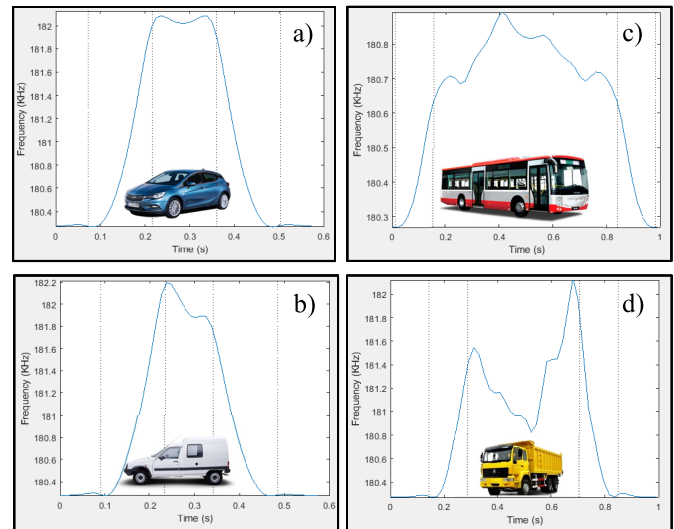

Fig. 3. Magnetic profiles. (a) Car. (b) Van. (c) Bus. (d) Truck.

- An electronic unit located in the control booth that contains an oscillator and amplifiers to excite the inductive loop.

Thus, when a vehicle or any object built with ferromagnetic materials passes through the magnetic field generated by a magnetic loop buried on the road, there is a decrease in the global magnetic field due to the currents that are induced in the vehicle, which results in the inductance of the loop also decreasing. Hence, the system, as a whole, results in a variation of the frequency as a function of time, which provides what is commonly known as “the vehicle magnetic profile” or “the vehicle inductance signature”.

This waveform depends mainly on parameters related to the vehicle such as length, engine position or number of axles. This is the reason why these waveforms are different for each type of vehicle, which allows through simple signal processing to obtain the speed and length and classify vehicles as bicycles, motorcycles, cars, trucks and buses [17]–[19], as seen in Fig. 3.

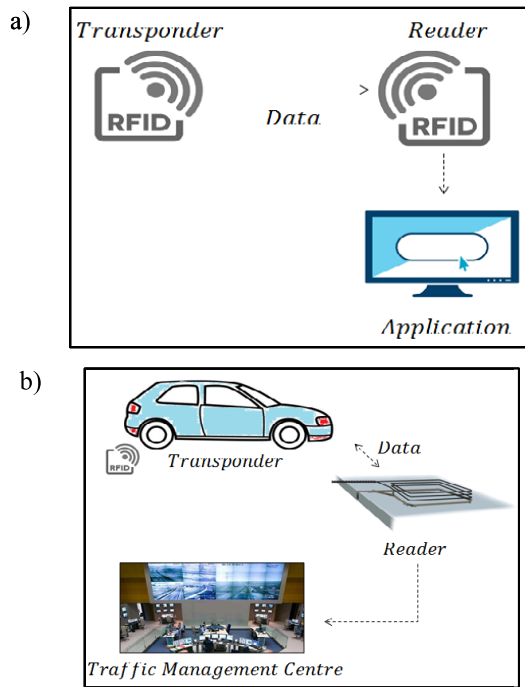

Fig. 4. RFID System. (a) Typical RFID system. (b) Traffic RFID system.



Fig. 5. RFID tags.

### III. RADIO-FREQUENCY-IDENTIFICATION SYSTEMS

Although RFID systems are post-World War II [20] and therefore, they might seem obsolete, these systems are actually receiving special attention in many fields of industry such as tracking systems and animal identification. This attention is the reason why there are continuous standards, applications and innovations today [21].

RFID systems take advantage of the already developed wireless technology for communication between a reader and a transponder. These types of systems are able to store information for future reading through radio frequency communication when needed. This information can range from a single bit to kilobytes, depending on the transponder storage system, and range from an identification number to a text. A typical RFID system is shown in Fig. 4(a), and Fig. 4(b) details how this system would be implemented in our case.

The transponder, also called an electronic tag or RFID card, contains a microchip with a tiny antenna that can adhere to any product or object (in our system, to any vehicle). In fact, transponders of such small size are currently being developed in order to pass unnoticed by any observer [22]. Figure 5 shows transponders of different styles and sizes depending on their utility.

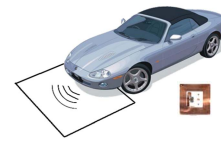

Fig. 6. RFID system for vehicle identification.

The operating mode of this system is also quite simple. When communication is required, the reader sends a series of radiofrequency waves to the tag, which are captured by the micro-antenna. These waves activate the microchip, which transmits the information stored in its memory to the reader. Finally, the reader receives the information sent by the electronic tag and relays it to a database in which the characteristics of the object or product have previously been registered. However, although it seems very intuitive and simple, several circuits have to be designed to ensure proper communication and the whole system has to adapt to the regulation.

### IV. PROPOSED SYSTEM

Our proposal for the identification of vehicles and exchange of information is the use of RFID technology together with magnetic loops described earlier. Using the proposed method, the lower part of vehicles would include an active electronic tag and magnetic loops would function as receiving antennas as shown in Fig 6, although the communication could also be made in the opposite direction.

These magnetics loops are currently being used by another system, which is in full operation today worldwide and is responsible for determining the type of vehicle, speed and many other traffic parameters. The oscillation frequency of these loops when operating as a traffic sensor is about tens of kHz, normally less than 200 kHz [7], and the signal only appears for a specific time interval since there is a period in which the loop is at rest without energy. Therefore, in order to also use these inductive loops as antennas, it has been proposed to occupy the time in which the loops are off. Using this approach, the RFID reader circuit would only operate at this time.

The reader system will consist of three basic stages:

- Magnetic loop – RFID system.
- Filtering.
- Signal amplification.

Magnetic loops will be responsible for detecting the signal emitted by the vehicles, and also form part of the other system mentioned above. In this way, the main problem will result from the incompatibility of working simultaneously, but with the implementation of a semiconductor switch with a two-position circuit function as shown in Fig 7, this problem will be solved. In this way, both systems would be isolated. The switch selected was the NLAS1053, which has the following characteristics:

- Semiconductor switch made with CMOS technology.
- Surface mount technology device.
- Resistance less than 10Ω.
- 50 MHz bandwidth.

Moreover, this can be easily controlled by a pulse that allows the loop to be connected to the desired system and

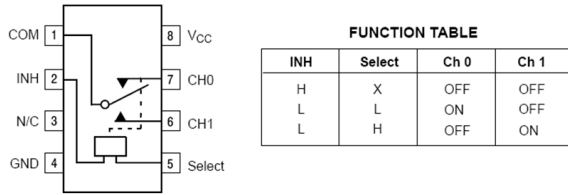

Fig. 7. Electrical scheme and operating mode of the NLA51053.

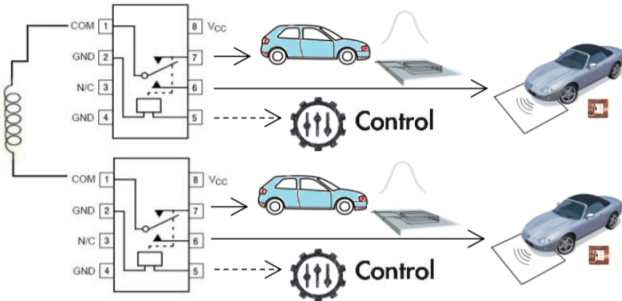

Fig. 8. Connection diagram of both systems.

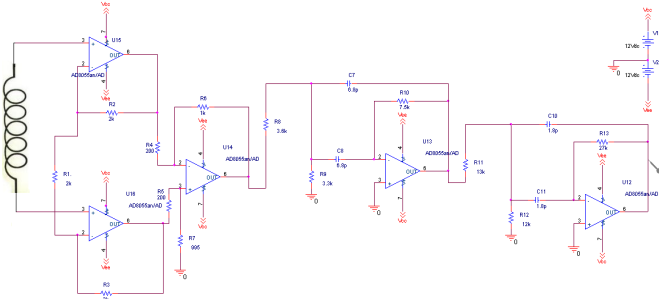

Fig. 9. Diagram of the filtering and amplification stage.

alternate both systems. The connection diagram is shown in Fig. 8.

Since the information will be exchanged while the vehicles are in motion over the loops, the data emission will require high frequencies. Accordingly, the frequency selected will be approximately 6.77 MHz, which is permitted within the short-range standard of inductive applications [23], [24].

Magnetic loops are known to typically be located below the asphalt, usually at 5 cm, which causes the loop to receive all types of unwanted signals. For this reason, the second and third stage of the reader system are related to the filtering and amplification of the signal. As the signal received in the inductor varies from 100 mV to 150 mV, the circuit shown in Fig. 9 was designed accordingly.

The diagram shown in Fig. 9 consists of two parts. The first part is composed of an AD8055 amplifier for signal conditioning with high impedance at the input and high rejection to the common mode whose most relevant characteristics are:

- 300 MHz Bandwidth.
- Surface mount technology device.
- Low noise,  $6 \text{ nV} / \sqrt{\text{Hz}}$ .

The second stage corresponds to an active bandpass filter based on the operational amplifier, AD8055, which amplifies and selects the signal of interest. These surface-mount devices

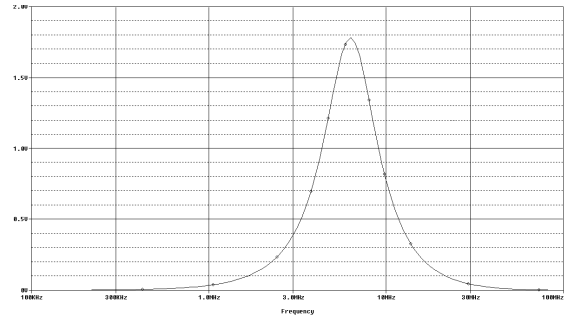

Fig. 10. Response of the circuit as a function of frequency.

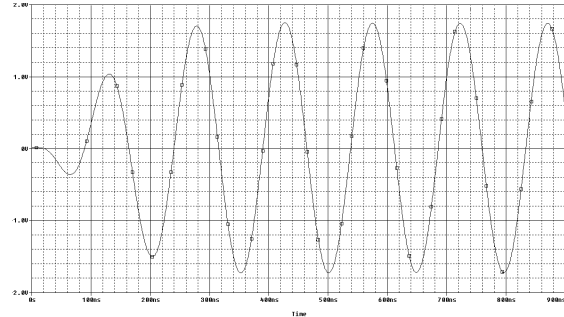

Fig. 11. Response of the circuit as a function of time.

were selected to reduce the size of the circuit, and minimize the connection between the board and the components.

The amplification level of the signal is shown as a function of frequency in Fig. 10 and as a function of time in Fig. 11.

The signal emitted by an RFID tag is always modulated, and depending on the modulation characteristics, a certain demodulation stage must be implemented to process the data and perform vehicle identification at the output of the reader system. In our case, the type of modulation used was Amplitudes-Shift Keying (ASK). This is an amplitude modulation where the modulating signal is digital and the two binary values are represented by two different amplitudes. Typically, one of the two amplitudes is zero, i.e., one of the binary digits is represented by the presence of the carrier at a constant amplitude, and the other digit is represented by the absence of the carrier signal [25]. Figure 12 is shown for clarification.

Finally, since it is known that power supplies can sometimes introduce low and high frequency noise, the implementation of capacitors was arranged at the power points of the amplifiers to avoid noise, following the recommendations of the signal conditioning as shown in Fig. 13.

## V. VERIFICATION PROCESS

After thoroughly explaining the methodology and necessary materials and circuits, the next step was to verify that the theoretical results coincided with the experimental results. For this reason, a magnetic loop was constructed in the laboratory by our research team (Group of Traffic Control System, ITACA Institute, Universitat Politècnica de València, Spain). The magnetic loop was implemented as detailed in our previous paper [19].

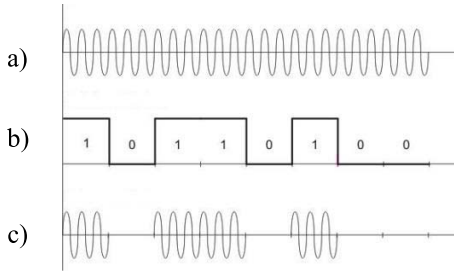

Fig. 12. ASK. (a) Carrier signal. (b) Modulating signal. (c) Modulated Signal.

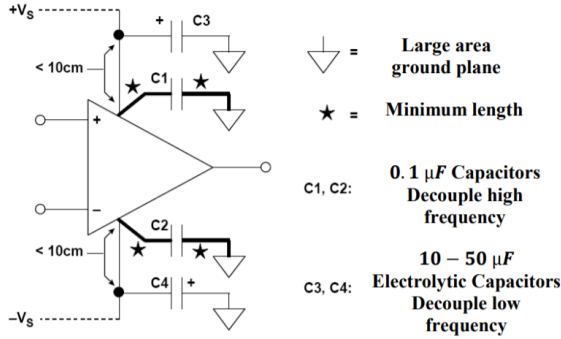

Fig. 13. Strategies to avoid noise.

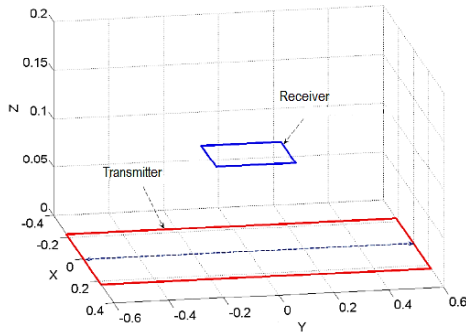

Fig. 14. RFID system scheme.

In it, the magnetic field generated by a loop was analyzed, but our current interest is to use this phenomenon as a means of communication. Therefore, it was necessary to use a receiver loop (RFID card installed in the vehicle) as shown in Fig. 14.

Faraday’s law states the following:

$$\varepsilon = \oint_l \vec{E} \cdot d\vec{l} = -\frac{d\phi}{dt} = -\frac{d}{dt} \int_s \vec{B} \cdot d\vec{S}$$

This equation shows it is possible to induce an electromotive force in a conductor in the presence of a variable magnetic field over time. Then, if the receiver is a rectangular loop located in the XY plane and parallel to the transmitting loop, the induced force will depend on the area occupied by the receiving loop, the magnetic field that crosses it perpendicularly ( $B_k$ ) [19] and the frequency. Consequently, these three aspects will be important for determining the magnitude of the electromotive force induced.

However, the equations that describe the magnetic field generated by a rectangular loop are observed to be

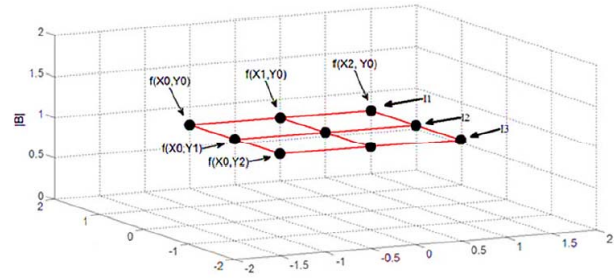

Fig. 15. Location of the points used to perform the double integration on the receiving loop.

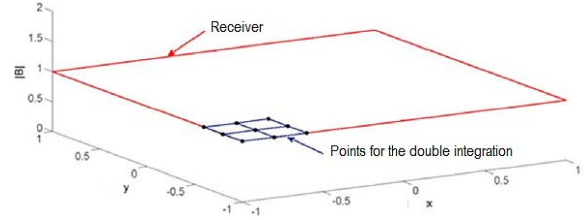

Fig. 16. Section inside the receiving loop.

complex [19]. Therefore, when calculating the electromotive force, it is difficult to obtain an analytical result. For this reason, a numerical solution was necessary.

In this manner, we opted for Simpson’s 1/3 Rule to solve the integrals. This method can be used to simply calculate integrals by using the evaluation of the function to be integrated in three different points within a range bounded by “a” and “b”, which are the dimensions of the loop according to the nomenclature used in [19]. Simpson’s 1/3 Rule is shown in the following equation [26].

$$I \approx (b - a) \frac{f(x_0) + 4f(x_1) + f(x_2)}{6}$$

where:

$$x_0 = a \quad x_1 = \frac{a + b}{2} \quad x_2 = b$$

However, since the integral is on the surface, a double integral had to be performed by taking nine points of the loop as shown in Fig. 15. Equation 3 shows how the double integration is applied with this method.

$$I_1 \approx (x_2 - x_0) \frac{f(x_0, y_0) + 4f(x_1, y_0) + f(x_2, y_0)}{6}$$

$$I_2 \approx (x_2 - x_0) \frac{f(x_0, y_1) + 4f(x_1, y_1) + f(x_2, y_1)}{6}$$

$$I_3 \approx (x_2 - x_0) \frac{f(x_0, y_2) + 4f(x_1, y_2) + f(x_2, y_2)}{6}$$

$$I_{double} \approx (y_2 - y_0) \frac{I_1 + 4I_2 + I_3}{6}$$

The double integration method applied to the receiving loop was carried out by dividing the loop into small sections. One of these sections is shown in Fig. 16. The results obtained from all of the sections that form the receiver loop were added to obtain the final result of the integral. The size of the sections into which the loop is divided is a function of

TABLE I  
FAILED TRANSMISSIONS

X-Axis Y-Axis	0.5	0.25	0	-0.25	-0.5
-1.25	1000	1000	1000	1000	1000
-1	1000	12	0	2	997
-0.75	115	0	0	0	107
-0.5	97	0	0	0	16
-0.25	99	0	0	0	41
0	103	0	0	0	0
0.25	28	0	0	0	0
0.5	15	0	0	0	0
0.75	31	0	0	0	4
1	950	3	0	0	922
1.25	1000	1000	1000	1000	1000

the variations in the slope of the signal to be integrated. In the case of the magnetic field generated by a rectangular loop, the variations are not so abrupt. Therefore, for later calculations, the receiving loop was divided into 100 sections.

With the integration of the magnetic field in the area occupied by the receiver loop, the electromotive force can be calculated by applying Equation 1. From that equation, the result of the integration has to be derived with respect to time. Therefore, the only parameter that is a function of time is the electric current signal applied to the emitting loop. If a sinusoidal signal is considered, a phase change will occur between the current signal emitted and the induced force when drifting. In addition, this phase change will also be dependent on the frequency of the emitted signal, since when the sine signal is derived a constant that multiplies the final result is obtained that corresponds to the angular frequency of the emitted signal.

After determining the behavior of the magnetic field generated by a rectangular loop, our research team designed a program capable of simulating the voltage induced in a second loop located in the area of influence of the transmitting loop. This allows the electromotive force induced in the receiver loop to be simulated depending on the magnetic field generated by a transmitting loop. Moreover, the number of turns and the dimensions of both loops can be selected and other important variables such as the distance between the parallel planes of both loops, the current of the transmitting loop and the frequency of the signal are included. Therefore, using the calculation method described above, the maximum values of the electromotive force induced at different points depending on the distance between both loops were calculated on the receiving loop. These results are shown in Fig 17.

To determine the limits of communication, many measurements dependent on the position were taken and are summarized in Table I as the number of failed transmissions. This table shows that when the emitting loop is located outside the area of the receiving loop, the data transmission is zero. Another point of high error rate occurs at locations near the corners of the receiver loop, and the best results are obviously located in the center of the receiver loop. The fact that the transmission of data only occurs within the area of the loop of greater dimension will be a great advantage for ITS applications as it will not disturb any other system.

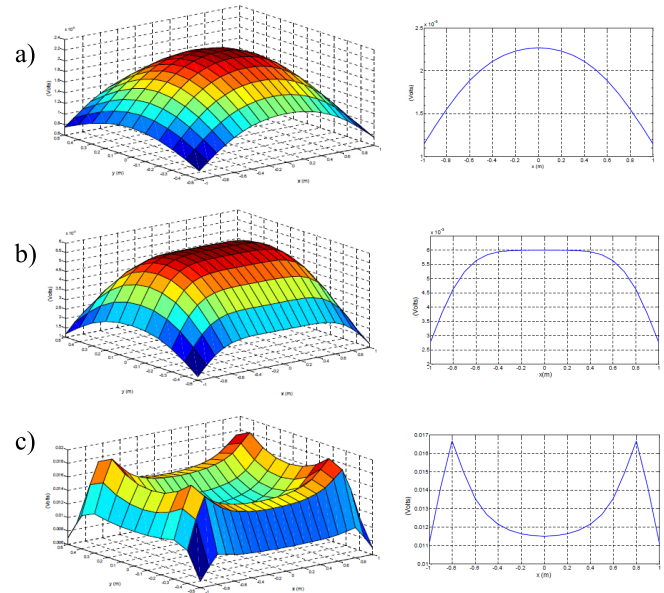

Fig. 17. (a) Electromotive force in the receiving loop, located parallel to the plane of the emitter loop at a distance of 1 m. (b) Electromotive force in the receiving loop, located parallel to the plane of the emitter loop at a distance of 0.5 m. (c) Electromotive force in the receiving loop, located parallel to the plane of the emitter loop at a distance of 0.1 m.

## VI. PILOT FIELD TRIALS

The system was also tested outside the laboratory to verify the design functioned correctly, since it is known that a system can function correctly in a controlled environment but vary its operation in a real environment. For complete verification of the operation of the system, several tests were carried out which could be grouped into two large categories: a semicontrolled environment and an uncontrolled environment.

In the semicontrolled environment, fixed magnetic loops located in the ‘Universitat Politècnica de València’ parking lot, a location the group of traffic control systems has for testing purposes, were used while for tests in the uncontrolled environment, portable loops in Doctor Waksman Avenue in Valencia were used in collaboration with the Valencia City Council.

For validation of the system, a test protocol was carried out for both scenarios, which allowed some deficiencies that occurred when operating in a real environment to be corrected. These problems were mainly due to the type of vehicle, since it significantly affects the emitter’s signal. Classic tourism does not exhibit the same behavior as a vehicle with much more mass, such as a truck. In addition, to provide the system with even greater utility, the tests were performed based on two utilities.

In the semicontrolled environment, tests were carried out to verify that the license plate transmission was correct. Different passenger cars with different dimensions and characteristics were used. However, in the uncontrolled environment, this communication was used to generate a green wave in priority vehicles. For this wave, we had a collaboration agreement with the City Council and carried out the tests with fire engines. The final objective was to obtain a system that facilitated the



Fig. 18. (a) Magnetic loops. (b) Test material. (c) RFID card in the rear part of the vehicle. (d) Mains socket.

circulation of priority vehicles through accurate detection of their position and activate traffic lights on their route.

In any case, it was necessary to verify the behavior of the system in both scenarios under certain premises:

- With absence of vehicle.
- With fixed presence of vehicle.
- With the vehicle passing at low speed.
- With the vehicle passing at high speed.

#### A. Semicontrolled Scenario

The objective of this test was to verify that both the receiving loop and the emitting transmitter circuit functioned correctly and that communication was possible. Although the system had been satisfactorily tested in laboratory conditions, the behavior in a real semicontrolled environment did not completely match the expectations.

When the emitter generates a signal, the information is transmitted through magnetic coupling with the ground loop. In this coupling, a signal formed by positive and negative peaks is obtained in the receiving loop that varies depending on the orientation of the transmitter. Therefore, in the first test, the orientation the transmitter should have to be received correctly and optimally was verified. For this verification, only a laptop, a power supply and the receiver were used as shown in Fig. 18(b).

The first option was to place the RFID card in the front of the vehicle chassis. However, since we could not drill the chassis for permanent installation, we chose to hold the emitter using flanges and tape as shown in Fig. 18(c). Although it may seem otherwise, there are not many points where the transmitter can be installed. We use the mains socket from the cigarette lighter as shown in Fig. 18(d).

This first test showed that the mass of the vehicle did not significantly affect the reception of the signal. The main problem appeared with the engine. When starting the vehicle engine, the signal received was automatically degraded making the system unfeasible. After studying the signal obtained in the receiver under the four premises mentioned above, it was



Fig. 19. Fire vehicles ceded by the Valencia council.

observed that the engine was introducing interference into the transmitter and the resulting signal was too degraded for the receiver to recover. Consequently, based on the fact that the engine is an important source of interference and cannot be eliminated, it was decided to move the emitter to the furthest point of the engine, i.e., to the rear of the vehicle.

With this configuration, the test was performed correctly. With the vehicle travelling at 30 km/h as it passed through the measurement point, the signal was perfectly captured by the system. A total of 100 trials were performed, of which only one failed. As the speed was increased to 60 km/h, no problems seemed to occur since the communication was successful more than 99% of the time. Problems due to speed began to appear at 100 km/h, where of the 100 tests performed, 8 failed.

#### B. Uncontrolled Scenario

To perform this test, both vehicles and magnetic loops were different. An agreement between the Polytechnic University of Valencia and the city council was made and, consequently, the test was carried out in the fire station located near Doctor Waksman Avenue. To carry out the tests, two fire vehicles were used, as shown in Fig. 19. The objective was also to communicate the license plate and generate a green wave.

One of the first steps in installing the transmitter was to verify that a signal was received with the vehicle stopped over the loop, with the engine stopped and running. Unlike the measurement point located in the university parking lot, no loops were installed on the road in the fire station, so it was necessary to use a  $2 \times 1$  m portable loop built by our research group.

As performed in the semicontrolled environment, we first tested the installation of the transmitter in the front of the vehicle, but we observed that the engine had a negative effect on the transmitter at this location and it was necessary to use a different location. As in the previous example, the transmitter was installed at the back of the vehicle. At this location, the reception system successfully detected the license plate.

For the demonstration, two measurement points on Doctor Waksman Avenue were selected, as shown in Fig. 20. Each point had two  $2 \times 1$  m portable loops per lane for a total of 4 passing points. In addition, to optimize the operation of the system, the reception circuit in each of the lanes was calibrated.



Fig. 20. Situation of measurement points.

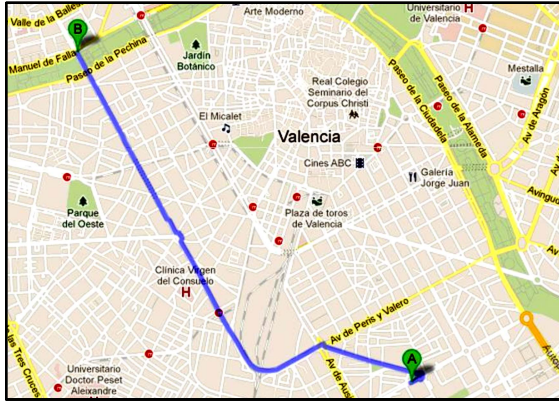

Fig. 21. Road travelled for the test.

To achieve the final objective, it was necessary to use other systems. The sender sent the license plate to the receiver, through which we detected the priority vehicle and its precise position (with knowledge of the vehicle dimensions, we were able to estimate the speed at which the vehicle circulated).

All of this information was sent to the other system on board the fire engine responsible for transmitting the detection notice. Upon receiving the notice, this information was sent to a third system that forwarded it to a server using a 3G data link, which finally reached the traffic control room of the city of Valencia.

Once the exact position of the vehicle was known, the traffic control center generated a green wave along the vehicle route to minimize the amount of stopping at the intersections and thus, reduce the time spent along the route. However, the activation of traffic lights is not a simple operation. The traffic lights cannot be arbitrarily green. This condition has to be coordinated with the traffic lights at the associated intersections. Consequently, this coordination led to two situations.

In the first tests, green waves were not generated. Only the proper functioning of the communication was verified, in which there were no problems associated with speed since fire engines rarely exceed 100 km/h in cities. The communication was successful more than 98% of the time. In the second tests, after 15 days in which the necessary traffic plans for the generation of a certain green wave were elaborated, the system was checked.

To determine the viability of the system, we developed a specific route in the city of Valencia that was made six times,

TABLE II  
GREEN WAVE VIABILITY

	Time	Time	Time	Average
<i>No Green Wave</i>	15.45	16.28	15.52	16.15
<i>Green Wave</i>	10.01	10.12	9.48	10.01

three without generating the green wave and three with generating the green wave. This was performed using five additional portable loops placed during the route. The route designed, as shown in Fig. 21, covered point A (fire station) to point B. The results are shown in Table II.

## VII. CONCLUSION

We have introduced a system based on magnetic loops and RFID tags as a good alternative to establish short-range communication between vehicles and infrastructure. Moreover, it has been shown that with a few simple low-cost circuits, the complete system can be implemented in any location. Since the communication will be carried out by magnetic coupling, it will result in minimal interference and variations due to the presence of water, dust or ice. In its favor, it should also be noted that its price would be approximately one tenth compared to systems such as smart reading license plates cameras.

To detect the presence of a priority vehicle, it is necessary to discriminate it from other vehicles. This discrimination was achieved by sending the vehicle registration to a receiver installed on the road, which is a tremendous advantage. These loops are already fully operational in most streets in the main cities, which would result in zero investment, as they would be reused and provided with even more functionality.

There are different geolocation systems in the market, but in urban environments these systems have some shortcomings. GPS is the most popular system and has an accuracy of several meters, but the presence of buildings causes the GPS signal to bounce which can result in position failures. In addition, in an avenue with buildings on the sides, the GPS signal could locate the vehicle inside a building, or the signal could be lost in a tunnel for example. Therefore, if we use this system to locate the vehicle and activate a green wave, mistakes could be made because the GPS may position the vehicle in the opposite lane of the road among many other problems. To solve this problem, a system that identifies a vehicle with an error of only a few centimeters has been proposed.

Our system has been validated by the test results, since the communication and license plate sent were satisfactory in 99% of the cases for speeds less than 100 km/h. In addition, through the collaboration with the council of Valencia, an experiment was carried out in a real environment in which the travel time of the fire engine was reduced by approximately 40%. This reduction could be applied to ambulances, police cars and other priority vehicles, saving lives and improving the quality of life of citizens.



Based on all of these reasons, magnetic loops present a great alternative as a means of short-range communication. In addition, the number of applications this system could offer are endless. Therefore, we encourage other researchers to develop applications based on the proposed system in this paper.

## REFERENCES

- [1] T. Zhang, L. Sun, L. Yao, and J. Rong, "Impact analysis of land use on traffic congestion using real-time traffic and POI," *J. Adv. Transp.*, vol. 2017, Oct. 2017, Art. no. 7164790. doi: [10.1155/2017/7164790](https://doi.org/10.1155/2017/7164790).
- [2] S. Raza, S. Wang, M. Ahmed, and M. R. Anwar, "A survey on vehicular edge computing: Architecture, applications, technical issues, and future directions," *Wireless Commun. Mobile Comput.*, vol. 2019, Feb. 2019, Art. no. 3159762. doi: [10.1155/2019/3159762](https://doi.org/10.1155/2019/3159762).
- [3] R. Florin and S. Olariu, "A survey of vehicular communications for traffic signal optimization," *Veh. Commun.*, vol. 2, no. 2, pp. 70–79, Apr. 2015.
- [4] Q. Wei and B. Yang, "Adaptable vehicle detection and speed estimation for changeable urban traffic with anisotropic magnetoresistive sensors," *IEEE Sensors J.*, vol. 17, no. 7, pp. 2021–2028, Apr. 2017.
- [5] F. Faheem, Z. Zuraidah, A. Kayani, and A. K. Aminuddin, "Optimization of vehicle actuation and multiplan algorithms for urban traffic control systems," in *Proc. IEEE Conf. Syst., Process Control (ICSPC)*, Dec. 2017, pp. 59–64. doi: [10.1109/SPC.2017.8313022](https://doi.org/10.1109/SPC.2017.8313022).
- [6] R. L. Anderson, "Electromagnetic loop vehicle detectors," *IEEE Trans. Veh. Technol.*, vol. VT-19, no. 1, pp. 23–30, Feb. 1970.
- [7] L. A. Klein, D. R. P. Gibson, and M. K. Mills, "Traffic detector handbook," Federal Highway Admin., U.S. Dept. Transp., Washington, DC, USA, Publication FHWAHRT-06-108, 2006.
- [8] M. Bugdol, Z. Segiet, M. Kręchichwost, and P. Kasperek, "Vehicle detection system using magnetic sensors," *Transp. Problems*, vol. 9, no. 1, pp. 49–60, 2014.
- [9] K. Liu, M.-Y. Cui, P. Cao, and J.-B. Wang, "Iterative Bayesian estimation of travel times on urban arterials: Fusing loop detector and probe vehicle data," *PLoS ONE*, vol. 11, no. 6, 2016, Art. no. e0158123. doi: [10.1371/journal.pone.0158123](https://doi.org/10.1371/journal.pone.0158123).
- [10] Y. K. Ki and D.-K. Baik, "Vehicle-classification algorithm for single-loop detectors using neural networks," *IEEE Trans. Veh. Technol.*, vol. 55, no. 6, pp. 1704–1711, Nov. 2006.
- [11] H. Wang, Z. Li, D. Hurwitz, and J. Shi, "Parametric modeling of the heteroscedastic traffic speed variance from loop detector data," *J. Adv. Transp.*, vol. 49, no. 2, pp. 279–296, 2015.
- [12] R. Want, "An introduction to RFID technology," *IEEE Pervasive Comput.*, vol. 5, no. 1, pp. 25–33, Jan./Mar. 2006.
- [13] F. C. Nemtanu, J. Schlingensiepen, D. Buretea, and V. Iordache, "Mobility as a service in smart cities," in *Proc. Responsible Entrepreneurship Vis., Develop. Ethics (ICEIRD)*, 2016, pp. 425–435.
- [14] S. Meta and M. G. Cinsdikici, "Vehicle-classification algorithm based on component analysis for single-loop inductive detector," *IEEE Trans. Veh. Technol.*, vol. 59, no. 6, pp. 2795–2805, Jul. 2010.
- [15] Y.-K. Ki and D.-K. Baik, "Model for accurate speed measurement using double-loop detectors," *IEEE Trans. Veh. Technol.*, vol. 55, no. 4, pp. 1094–1101, Jul. 2006.
- [16] J. Gajda *et al.*, "Measurement of road traffic parameters," (in Polish), Pub. House PWN, Warsaw, Poland, Tech. Rep., 2015.
- [17] F. M. Belenguer, A. M. Salcedo, V. M. Sánchez, and J. H. A. Núñez, "Double magnetic loop and methods for calculating its inductance," *J. Adv. Transp.*, vol. 2018, Sep. 2018, Art. no. 6517137. doi: [10.1155/2018/6517137](https://doi.org/10.1155/2018/6517137).
- [18] F. M. Belenguer, A. M. Salcedo, A. G. Ibañez, and V. M. Sánchez, "Advantages offered by the double magnetic loops versus the conventional single ones," *PLoS ONE*, vol. 14, no. 2, 2019, Art. no. e0211626. doi: [10.1371/journal.pone.0211626](https://doi.org/10.1371/journal.pone.0211626).
- [19] A. Mocholí-Salcedo, J. H. Arroyo-Núñez, V. M. Milián-Sánchez, G. J. Verdú-Martín, and A. Arroyo-Núñez, "Traffic control magnetic loops electric characteristics variation due to the passage of vehicles over them," *IEEE Trans. Intell. Transp. Syst.*, vol. 18, no. 6, pp. 1540–1548, Jun. 2017.
- [20] B. Violino, "The history of RFID technology," *RFID J.*, pp. 1–2, Jan. 2005.
- [21] X. Zhu, S. K. Mukhopadhyay, and H. Kurata, "A review of RFID technology and its managerial applications in different industries," *J. Eng. Technol. Manage.*, vol. 29, no. 1, pp. 152–167, 2012.
- [22] A. El Hamraoui, E. H. Abdelmounim, J. Zbitou, H. Bennis, M. Latrach, and A. Errkik, "A low cost miniature UHF RFID tag antenna using paper substrate," in *Proc. IEEE Int. Conf. Wireless Technol., Embedded Intell. Syst. (WITS)*, Apr. 2017, pp. 1–6. doi: [10.1109/WITS.2017.7934685](https://doi.org/10.1109/WITS.2017.7934685).
- [23] I. Lacmanović, B. Radulović, and D. Lacmanović, "Contactless payment systems based on RFID technology," in *Proc. IEEE 33rd Int. Conv. Inf. Commun. Technol., Electron. Microelectron.*, May 2010, pp. 1114–1119.
- [24] B. Violino, "A summary of RFID standards," *RFID J.*, pp. 1–3, Jan. 2005.
- [25] K. Finkenzerler, *RFID Handbook: Fundamentals and Applications in Contactless Smart Cards and Identification*. Hoboken, NJ, USA: Wiley, May 2003.
- [26] S. C. Chapra and R. P. Canale, *Métodos Numéricos Para Ingenieros*. New York, NY, USA: McGraw-Hill, 2010.



**Ferran Mocholí Belenguer** was born in Valencia, Spain, in 1992. He received the B.S. degree in telecommunications engineering from the Polytechnic University of Valencia, Valencia, in 2014, the B.S. degree in music from professional music conservatory 'Jose Manuel Izquierdo', Catarroja, Spain, in 2016, and the M.S. degree in acoustic engineering from the Polytechnic University of Valencia, in 2019, where he is currently pursuing the Ph.D. degree in telecommunication engineering. Since 2016, he has been a Research Assistant with the Group of Traffic Control Systems, ITACA Institute. His research interests include the development of new traffic sensors based on magnetic loops and laser technology, infrastructure homologation according to different standards, and magnetic characterization of vehicles.



**Antonio Martínez-Millana** received the Ph.D. degree in Technologies for Health and Wellbeing from the Polytechnic University of Valencia, Spain, in 2017. He is currently with a Research Assistant for European e-Health projects in ITACA and a Lecturer with the Department of Electronic Engineering, Universitat Politècnica de València. His research interests include diabetes, mathematical modeling, biomedical engineering, and process mining.



**Antonio Mocholí Salcedo** received the Ph.D. degree in industrial engineering from the Polytechnic University of Valencia, Spain, in 1991. He is currently a Professor with the Department of Electronic Engineering, Polytechnic University of Valencia, where he is also the coordinator of the Traffic Control Systems (STC) Group, ITACA Institute. His research interests include the development of new traffic sensors based on magnetic loops and laser technology, development of protocols for homologation of equipment, and development of V2V and V2V communications.



**José Humberto Arroyo Núñez** received the M.Sc. degree from the National Institute of Astrophysics, Optics and Electronics, México, in 2002. He is currently a Professor with the Department of Electronic and Telecommunications Engineering, Polytechnic University of Tulancingo, México, where he is also the coordinator of the Electronic and Telecommunications Engineering. His research interests include the development of road protocols for traffic management and the study of the behavior of magnetic loops.