

# Design of Second Order Sliding Mode and Sliding Mode Algorithms: A Practical Insight to DC-DC Buck Converter

Seyed Mehdi RakhtAla, Monazzahalsadat Yasoubi, and Hassan HosseinNia

**Abstract**—This paper presents a simple and systematic approach to design second order sliding mode controller for buck converters. The second order sliding mode control (SOSMC) based on twisting algorithm has been implemented to control buck switch mode converter. The idea behind this strategy is to suppress chattering and maintain robustness and finite time convergence properties of the output voltage error to the equilibrium point under the load variations and parametric uncertainties. In addition, the influence of the twisting algorithm on the performance of closed-loop system is investigated and compared with other algorithms of first order sliding mode control such as adaptive sliding mode control (ASMC), non-singular terminal sliding mode control (NTSMC).

In comparative evaluation, the transient response of the output voltage with the step change in the load and the start-up response of the output voltage with the step change in the input voltage of buck converter were compared. Experimental results were obtained from a hardware setup constructed in laboratory. Finally, for all of the surveyed control methods, the theoretical considerations, numerical simulations, and experimental measurements from a laboratory prototype are compared for different operating points. It is shown that the proposed twisting method presents an improvement in steady state error and settling time of output voltage during load changes.

**Index Terms**—DC-DC buck converter, non-singular-terminal sliding mode, second order sliding mode, twisting algorithm.

## I. INTRODUCTION

DC-DC buck converters are powerful electronic tools which have a wide range of functionality in various cases such as telecommunication equipment and power supplies for personal computers [1]. The DC-DC buck converters are applied in devices where required output voltage is smaller than the input voltage. Due to switching operation of buck converters, they have a nonlinear and time-varying structure.

Manuscript received January 14, 2016; accepted October 20, 2016. Recommended by Associate Editor Haitao Fang. (Corresponding author: Hassan HosseinNia.)

Citation: S. M. RakhtAla, M. Yasoubi, and H. HosseinNia, "Design of second order sliding mode and sliding mode algorithms: a practical insight to DC-DC buck converter", *IEEE/CAA J. of Autom. Sinica*, vol. 4, no. 3, pp. 483–497, Jul. 2017.

S. M. RakhtAla is with the Department of Electrical Engineering, Golestan University, Gorgan 4913456728, Iran (e-mail: sm.rakhtala@gu.ac.ir).

M. Yasoubi is with the Department of Electrical and Computer Engineering, Concordia University, Montreal H3G1M8, QC, Canada (e-mail: myasoub@encs.concordia.ca).

H. HosseinNia is with the Department of Precision and Microsystem Engineering, Delft University of Technology, Delft 2628CD, Netherlands (e-mail: s.h.hosseinia@tudelft.nl).

Color versions of one or more of the figures in this paper are available online at <http://ieeexplore.ieee.org>.

Digital Object Identifier 10.1109/JAS.2017.7510550

Classical linear control methods such as PI, PID are typically designed for one nominal operating point, but small-signal model of DC-DC converters changes with fluctuations in the operating point. However, due to inherent nonlinearity of the system, the linear control methods can only ensure small signal stability. In case of changing the converter parameters as uncertainty, load disturbances, a PID controller may not respond well to significant changes in operating points [1]. Thus, nonlinear control methods are used for these systems to ensure system stability in arbitrary operating condition with good dynamic response and with rejection of input voltage changes, load fluctuations and parameter uncertainties. Among these nonlinear control strategies, the sliding mode control (SMC) is a form of variable structure control (VSC). The SMC has more advantages such as ensuring the stability, robustness against parameter variations, fast dynamic response and simplicity in practical application [2], [3].

Second-order sliding mode control (SOSMC) has been actively developed for chattering attenuation and robust control of uncertain systems with relative degree two. The main idea is to reduce to zero, not only the sliding surface, but also its second-order derivative. The second-order sliding mode corresponds to the control acting on the second derivative of the sliding surface [4].

It should be noted that different SOSMC algorithms have been reported such as the "twisting" and "super-twisting" [5], "sub-optimal" [6] etc. In Bartolini *et al.* [6], an optimal version of second-order sliding mode of the so-called twisting algorithm has been presented. It has been used for systems with the relative degree of  $r = 2$  [7]. Nonsingular terminal sliding mode control (NTSMC) eliminates the singularity problem which arises in the terminal sliding mode due to the fractional power, this aspects is introduced in [8].

## II. REVIEW OF RELATED LITERATURE

ON-OFF is the only admissible operation mode for power converters; therefore sliding mode is an appropriate tool to control power converters [9]–[12]. Sliding mode (SM) controllers are types of nonlinear systems, which have guaranteed stability and fast dynamic response and simple implementation. They are robust to parameters uncertainty, load and disturbances [3], [13]–[17].

According to their simple structure, they have superiority to other nonlinear controllers. The implementation of sliding mode controllers in power converters are often restricted by

three major concerns: the non-constant operating frequency of the SM controller, a phenomenon called chattering and the presence of steady-state error and ripple in the regulation [18], [19].

In 2003, Sira-Ramirez introduced a type of hysteresis bandwidth modulation to control SM which included the general proportional integral controller [20]. In Bensaada *et al.* [21], the sliding mode control based on genetic algorithm has been examined for buck converter. The appropriate sliding surface is selected by assigning poles combined with genetic algorithm. The pole placement is used as an effective approach to restrict the robust control parameters zone. The combination of genetic algorithm with the pole placement method will allow further delimiting the best robust poles in this zone. This controller can offer fast dynamical response and suitable large signal control performances. However, disadvantages exist for this approach based on sliding mode control. In sliding mode control, the switching frequency can be infinite for ideal case. Although, in practice, it is impossible to change the control infinitely fast because of the time delay for control computations and physical limitations of switching devices. Therefore, the main obstacle for sliding mode control implementation is a phenomenon called chattering in control literature or ripple in power converter literature or oscillation in the output voltage.

Sliding mode control methods by Tsai and Chen (2007) [14] were based on DC-DC buck converter model with bilinear terms. Tanet *et al.* in 2007 [22], presented an indirect sliding mode control of power converters with the conventional hysteresis-modulation-based sliding mode controller. It is found that with the indirect type of sliding mode controller based on the equivalent control approach, is ineffective in alleviating the converter's steady-state error.

In 2008, a systematic and simple approach for designing SM controllers is presented by Tan *et al.* [22]. Indirect sliding mode control with sliding surface method to reduce the steady-state error of output voltage was introduced by Tan *et al.* [22], although two additional states in sliding surface function are applied. In 2011, Jafarian and Nazarzadeh [23] introduced a time-optimal based sliding mode control assisting improvement of buck converter output voltage under any disturbance. In addition to expanding the sliding mode control theory for power converters, performance evaluation and comparison with other control methods are presented. In 2002, Second-order sliding mode controller was applied to reduce vibration problem for buck converter by Fossas and Ras [24].

The adaptive terminal sliding mode control (ATSMC) is introduced in [25], having advantages of assuring finite time convergence of the output voltage error to the equilibrium point and integrate an adaptive law to the TSMC strategy so as to make the sliding line dynamic during the load variations.

An  $H_\infty$  robust static output fuzzy controller for DC-DC converters using Takagi-Sugeno fuzzy models was proposed in [26]. In the proposed approach, the controller is designed using the output voltage, which is the measured signal. In [26], a fuzzy bilinear state feedback controller based on Takagi-Sugeno (TS) fuzzy bilinear model for DC-DC converters is proposed. Baek and co-workers design a fuzzy bilinear state feedback controller to track the reference output voltage.

Liu *et al.* [27] in 2013 presented an adaptive-gain, second order sliding mode observer for multi-cell converters. In this research, Liu *et al.* presents an estimator of capacitor voltage by measurement of voltage and the load current. The proposed observer is proven to be robust in the presence of perturbations and uncertainty. Furthermore, Liu *et al.* presented power factor control of a full-bridge boost power converter using output higher order sliding mode control. Liu and his colleague used a super-twisting sliding mode observer to estimate the input currents and load resistance only from the measurement of output voltage. A high order sliding mode observed is used to limit the chattering which is very robust against disturbances. Therefore this observer is very useful for close loop control system. The close loop control forces the input currents to track the desired values, which can control the output voltage while keeping the power factor close to one [28].

#### A. Main Contribution

First, nonlinear model of DC-DC buck converter is obtained in which the output voltage error ( $x_1$ ) and its time derivative ( $x_2$ ) are considered as the state variables. Then, the second order sliding mode control is applied. Sliding mode control requires control signals to commute at a theoretically infinite frequency. Particularly, this is not applicable in practical plants. For the purpose of avoiding high frequency oscillations, the second order sliding modes is a practical technique that has been proved to be effective in chattering attenuation.

In this paper, nonlinear controller such as second-order sliding mode control with twisting algorithm has been applied to DC-DC buck converter because of its nonlinear properties. Although both first orders sliding and second order sliding mode controllers have proper characteristics, the second order sliding mode controller benefits from the advantages of both first order and second order sliding mode controllers.

In SMC, ASMC and NTSMC the sliding surface has relative degree of one with respect to the control input. That means the control input acts on the first derivative of the sliding surface. Therefore, chattering happens due to the inclusion of this sign function. The main idea is to reduce the chattering to zero, not only the sliding surface, but also its second-order derivative. It means that the second-order sliding mode corresponds to the control acting on the second derivative of the sliding surface.

Our main contribution in this paper is the use of second order sliding mode controller with twisting algorithm for chattering suppression and to maintain robustness and finite time convergence properties under load variations and parametric uncertainties.

In this research, experimental validation of the proposed controller is carried out on an instrumented hardware in the loop (HIL) test bench whose hardware setup is constructed for a prototype buck converter and control algorithms were implemented with DAQ-Advantech multifunction card in MATLAB-real-time environment. Practical parameters of the controller are extracted by practical implementation and stability analysis. Experimental implementation of twisting algorithm in SOSMC and SMC, ASMC and NTSMC for the first order sliding mode control methods studied in this paper is

compared in four aspects: 1) startup response, 2) rejecting the disturbance of load resistance, 3) changing the input voltage and 4) tracking the set point by changing the desired voltage. Quantitative evaluation of comparisons of output voltage for four control methods of sliding mode algorithms is done.

The comparison between the first order sliding mode algorithm and the second order sliding mode of twisting algorithm has been demonstrated and it is shown that the proposed SOSMC system achieves the best tracking specifications in the case of external disturbances, best behavior in reference tracking and also faster convergence of the sliding surface while the stability is maintained. Experimental validation of the present design proves that the control and tracking performance is improved in presence of uncertainties and disturbances while the stability is maintained.

The rest of the paper is organized as follows: State space model of the DC-DC buck converter will be obtained in Section III. Section IV presents the second order sliding mode control and twisting algorithm designed for buck converter. Stability analysis of non-singular terminal sliding mode control method for buck converter will be studied in Section V. Section VI reviews the sliding mode control algorithms for DC-DC buck converter with four different algorithms under perturbed condition and the step change in the input voltage. Finally, the paper will be concluded in Section VII.

### III. STATE SPACE MODEL OF THE DC-DC BUCK CONVERTER

DC-DC buck power converter converts input DC voltage to a lower voltage level. Fig. 1 shows the buck converter. Because of diode and MOSFET as a switching element, it has a nonlinear structure and as a result of the presence of two energy storing elements, the system is second order [29], [30].

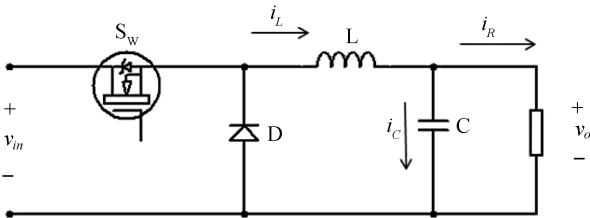

Fig. 1. DC-DC buck converter circuit.

The state-space equations of state variables such as voltage of the capacitor (or output voltage) and current of the inductor is obtained in following steps. In the first step, switch  $S_w$  is ON for which the state equation can be written as:

$$\begin{cases} \frac{di_L}{dt} = \frac{1}{L} (v_{in} - v_o) \\ \frac{dv_o}{dt} = \frac{1}{C} \left( i_L - \frac{v_o}{R} \right) \end{cases} \quad (1)$$

In the second step,  $S_w$  switch is opened (OFF). When the diode D conducts, the circuit is equal to parallel RLC and the

equations are as follow:

$$\begin{cases} \frac{di_L}{dt} = -\frac{v_o}{L} \\ \frac{dv_o}{dt} = \frac{1}{C} \left( i_L - \frac{v_o}{R} \right) \end{cases} \quad (2)$$

Combining (1) and (2) with ON and OFF switching control  $u$  we have:

$$\begin{cases} \frac{dv_o}{dt} = \frac{1}{C} \left( i_L - \frac{v_o}{R} \right) \\ \frac{di_L}{dt} = \frac{1}{L} (uv_{in} - v_o) \end{cases} \quad (3)$$

The output voltage error  $x_1$  and the changes of the output voltage error rate are defined as:

$$x_1 = v_o - V_{ref} \quad (4)$$

$$x_2 = \dot{x}_1 = \frac{dv_o}{dt} \quad (5)$$

The output voltage error ( $x_1$ ) and its time derivative ( $x_2$ ) are considered as the state variables, so the final state equations for buck converter with a voltage controller, is presented in (6) where  $\omega_o^2 = 1/LC$  is the resonance frequency [29], [31].

$$\begin{cases} \dot{x}_1 = x_2 \\ \dot{x}_2 = -\frac{x_2}{RC} - \omega_o^2 x_1 + \omega_o^2 (uv_{in} - V_{ref}) \end{cases} \quad (6)$$

### IV. SECOND ORDER SLIDING MODE

Sliding mode technique is based on principles of variable structure control (VSC) and has different names since 1934, and sliding mode control is well known as the dominant control method to provide a robust control under parameters uncertainties and unknown perturbations, as published by Utkin [31]. In sliding mode technique is defined as output function or “sliding manifold”, and it uses a discontinuous control to converge the system states trajectories to a “sliding manifold” and this manifold converges to zero in finite time [32], [33].

Unfortunately, the high frequency switching generated by the discontinuous control is not always applicable due to technological constraints. This results in unwanted high frequency fluctuation or “chattering” in the system output [32]. In order to suppress chattering, a high order sliding mode control (HOSMC) technique was proposed, and has been established as the most successful chattering avoidance method [34], [35]. In HOSMC, the discontinuous control is applied on some higher time derivative of the system, instead of influencing the first derivative of deviation as in SMC. Therefore, the real control law is almost continuous, smooth and chattering is suppressed [34]. Consider a single-input single-output nonlinear affine system:

$$\begin{aligned} \dot{x} &= f(x) + g(x)u \\ y &= s(x, t) \in \mathbb{R}, u = u(x, t) \in \mathbb{R} \end{aligned} \quad (7)$$

where  $f$  and  $g$  are smooth uncertain functions.  $s(x, t)$  is a sliding variable, dependent upon the state trajectories. The second order sliding manifold is defined as following equation:

$$s^2 = \{x \in \mathbb{R}^n \mid s(x, t) = \dot{s}(x, t) = 0\} \quad (8)$$

Second order sliding mode control (SOSMC) is the most common method, which forces the sliding surface and its first time derivative  $s(x, t)$  and  $\dot{s}(x, t)$  to zero by applying a discontinuous control on the second time derivative  $\ddot{s}(x, t)$  [30]. If the system has a relative degree one with respect to the sliding variable, the control  $u$  appears in the first derivative of  $s(x, t)$ , then this system is defined as:

$$\begin{aligned}\dot{s} &= \frac{\partial s(x, t)}{\partial t} + \frac{\partial s(x, t)}{\partial x} \cdot (f(x) + g(x)u) \\ \ddot{s} &= \frac{\partial \dot{s}(x, t, u)}{\partial t} + \frac{\partial \dot{s}(x, t, u)}{\partial x} \cdot (f(x) + g(x)u) + \frac{\partial \dot{s}(x, t, u)}{\partial u} \dot{u} \\ &= \phi(x, t) + \gamma(x, t)v\end{aligned}\quad (9)$$

where  $\phi(x, t)$  and  $\gamma(x, t)$  are smooth functions that have to be bounded as follows:

$$\begin{aligned}\phi(x, t) &= \frac{\partial \dot{s}(x, t, u)}{\partial t} + \frac{\partial \dot{s}(x, t, u)}{\partial x} \cdot (f(x) + g(x)u) \\ \gamma(x, t) &= \frac{\partial \dot{s}(x, t, u)}{\partial u}\end{aligned}\quad (10)$$

where the discontinuous control is applied on  $v = \dot{u}$  while system (7) is controlled by  $u$ . In order to stabilize the system to zero in finite time and design a robust controller with second order sliding mode, the following conditions must be met [18], [36], [37]:

$$\phi(x, t) > 0; \quad |\phi(x, t)| \leq C; \quad 0 < \Gamma_m \leq \gamma(x, t) \leq \Gamma_M.$$

#### A. Second Order Sliding Mode Control (SMC) With Twisting Algorithm for Buck Converter

Using twisting algorithm, an SOSMC controller is designed for Buck converter. First an appropriate sliding variable and then the control law concerning the twisting algorithm are applied for the Buck converter. Since the purpose of the sliding mode control for buck converter is to control the output voltage ( $v_o$ ), the sliding surface for applying the SOSMC via twisting algorithm in buck converter system can be defined  $s = v_o - V_{\text{ref}}$ .

By calculating  $\ddot{s}$ , based on the state equation of the buck converter (6), its related equation is changed into the standard equation of (11):

$$\ddot{s} = \left( \frac{1}{R^2 C^2} - \frac{1}{LC} \right) v_o - \frac{1}{RC^2} i_L + \frac{v_{in}}{LC} u. \quad (11)$$

Therefore we have:

$$\begin{cases} \phi = \left( \frac{1}{R^2 C^2} - \frac{1}{LC} \right) v_o - \frac{1}{RC^2} i_L \\ \gamma = \frac{v_{in}}{LC} \end{cases} \quad (12)$$

where  $\gamma$  is limited by  $0 < \Gamma_m \leq \gamma \leq \Gamma_M$ . Control laws and restrictions on its parameters are obtained from the ones similar to those mentioned in (8), (9) and (10). Therefore, the control law is defined by the following expression:

$$u = -\alpha_1 \text{sign}(s) + \alpha_2 \text{sign}(\dot{s}) \alpha_1 > \alpha_2 \quad (13)$$

where the controller parameters such as  $\alpha_1$  and  $\alpha_2$  are defined as  $\alpha_1 = \alpha * U$  and  $\alpha_2 = U$ . Then, the sufficient conditions for finite time convergence of the sliding manifold  $s$  are:

$$\begin{cases} U > \frac{\phi}{\Gamma_m} \\ \alpha * > \frac{2\phi + \Gamma_M U}{\Gamma_m U} \end{cases} \quad (14)$$

where the control parameters in twisting algorithm for buck converter are  $\alpha_1 = 9.6$  and  $\alpha_2 = 0.8$ .

#### B. Designing Second Order Sliding Mode Controller (SOSMC) via Twisting Algorithm for Buck Converter

In this section, the restrictions in the parameters of the SOSMC controller with twisting algorithm for buck converter are calculated with the parameters specified in Table I.

TABLE I  
PARAMETERS OF THE BUCK CONVERTER CONTROLLED VIA TWISTING ALGORITHM

Parameter	Nominal value
$\phi$	$5.1 \times 10^6$
$\Gamma_m$	$7 \times 10^6$
$\Gamma_M$	$13 \times 10^6$

Firstly, the restrictions and the below intervals are considered for  $R_L$ ,  $v_{in}$ ,  $v_o$ , and  $i_L$  parameters of the buck converter. Indeed, these limits present the amount of allowable disturbances, uncertainty, and the desired steady state error (for the buck converter output voltage and inductor current). The values of  $L$  and  $C$  are assumed to be constant.

$$\begin{cases} 7 \text{ V} < v_{in} < 13 \text{ V} \\ 2 \Omega < R < 40 \Omega \\ i_L - \frac{V_{\text{ref}}}{R} = \pm 0.1 \text{ A} \\ \Delta v_o = 0.01 \text{ V} \end{cases} \quad (15)$$

In the steady state, inductor current is equal to:  $i_L = \frac{V_{\text{ref}}}{R}$ . And, the desired error tolerance is considered to be around 0.1 A. The output voltage tolerance is considered as 0.01 V around the desired value ( $V_{\text{ref}}$ ). Now, using the definition of allowable changes for the buck converter in (15) and by inserting relations for  $\phi$  and  $\gamma$ , restriction parameters ( $\phi$ ,  $\Gamma_m$ , and  $\Gamma_M$ ) are calculated as follow:

$$\begin{aligned}\varphi &= |\phi|_{\max} = \left| \left( \frac{1}{R^2 C^2} - \frac{1}{LC} \right) v_o - \frac{1}{RC^2} i_L \right|_{\max} \\ &= \left| \frac{1}{LC} v_o + \frac{1}{RC^2} (i_L - \frac{v_o}{R}) \right|_{\max} \\ \varphi &= \left| \frac{1}{LC} v_{o(\max)} + \frac{1}{R_{\min} C^2} \left( \left( \frac{V_{\text{ref}}}{R} + 0.1 \right) - \frac{v_{o(\min)}}{R_{\min}} \right) \right| \\ &\approx 5.1 \times 10^6\end{aligned}\quad (16)$$

$$\Gamma_m = \frac{1}{LC} v_{in(\min)} = 7 \times 10^6 \quad (17)$$

$$\Gamma_M = \frac{1}{LC} v_{in(\max)} = 13 \times 10^6. \quad (18)$$

By putting the values of Table I in (11), the following convergence conditions for the controller parameters are obtained:

$$\begin{cases} U > 0.57 \\ \alpha^* > 4.42. \end{cases} \quad (19)$$

#### V. ADAPTIVE SLIDING MODE CONTROL FOR BUCK CONVERTER

In the sliding mode control, the parameter  $\lambda$  corresponding to the nominal load conditions can be considered to be constant. This is an inappropriate approach as it may lead to poor performance in the cases where changes in operating conditions are large. The parameter  $\lambda$  is proportional to the capacity of the capacitor filter (C) and load resistance ( $R_L$ ),

$C$  is a constant parameter and  $\lambda$  is calculated through  $\lambda = 1/(R_L C)$ . The adaptive sliding mode control method for controlling the buck converter voltage, leads to a more effective performance against disturbances and system uncertainties such as changes in the load resistance. This method is similar to the SMC method; the only difference is that in this method the parameter  $\lambda$  in sliding line (19) is not constant. Thus, (20)

$$R_L = \frac{v_o}{i_R} \quad (20)$$

where  $i_R$  and  $v_o$  are the load resistance current and the output voltage respectively. Fig. 2 illustrates the circuit diagram of a DC-DC buck converter controlled by ASMC method.

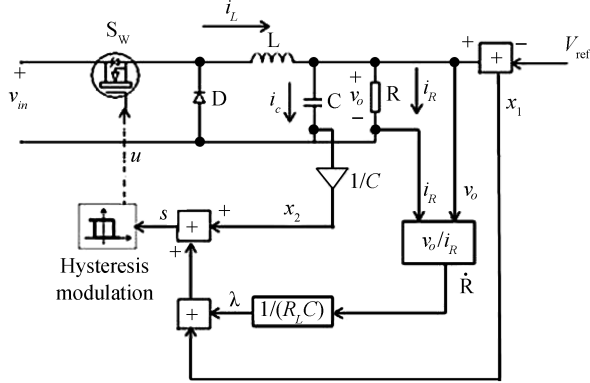

Fig. 2. ASMC controller block diagram for buck converter.

#### VI. NON-SINGULAR TERMINAL SLIDING MODE CONTROL METHOD FOR BUCK CONVERTER

NTSMC method uses a nonlinear function as sliding surface. The nonlinear sliding surface function is able to provide a finite-time convergence of the error from an initial point to the equilibrium point. The following equation, which represents the sliding surface, is used for this type of controller in buck converter application [31]:

$$S_n = x_1 + \lambda \dot{x}_1^{\frac{1}{\gamma}} = 0 \quad (21)$$

where  $\lambda > 0$  is the stability condition and where  $\lambda = (1/\lambda)^{1/\gamma}$  and  $1 < 1/\gamma < 2$ . Its dynamics is represented by the following equation:

$$-\dot{x}_1^{\frac{1}{\gamma}} = \frac{1}{\lambda} x_1. \quad (22)$$

Fig. 3 represents the block diagram of a DC-DC buck converter applying the NTSMC control technique.

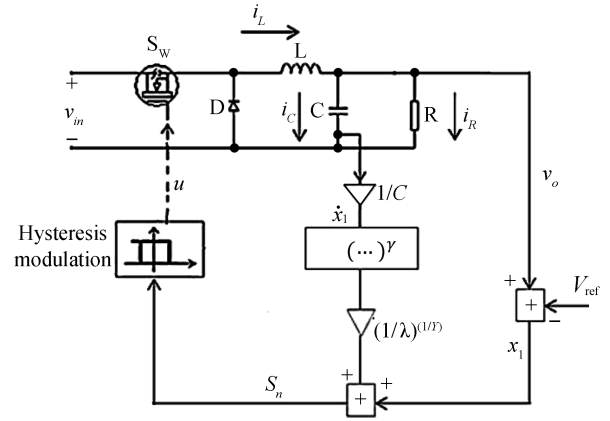

Fig. 3. Buck converter control system block diagram using NTSMC.

#### A. The Equivalent Control Input ( $u_{eq}^{NTSMC}$ ) for NTSMC

The control law of the sliding mode control is obtained by solving  $\dot{s}_n = 0$  equation. The  $u_{eq}^{NTSMC}$  is obtained when the time derivation of sliding surface becomes zero [31]. The following equation represents the control law ( $u$ ).

$$-\dot{x}_1^{\frac{1}{\gamma}} = \frac{\gamma}{v_{in} \omega_o^2 \lambda} \left( \frac{\lambda x_2}{\gamma RC} + \frac{\omega_o^2 \lambda}{\gamma} (V_{ref} + x_1) - x_2^{2-\frac{1}{\gamma}} \right). \quad (23)$$

In (23), it is clear that  $1 < 1/\gamma < 2$ , which means  $q < p < 2q$ , thus, the power of  $x_2$  in (23) is not negative. The equivalent control input in (23), when  $x_2 = 0$ , would not become infinite and the singularity problem would not happen in the NTSMC [31].

The equivalent control could not change the system state variables from the reaching mode to the sliding mode. Thus, an additional control law that is called switching control must be added, and the main control input ( $u_T$ ) is created in (24):

$$u_T = u_{eq}^{NTSMC} + u. \quad (24)$$

Also, the equivalent input  $u_{eq}^{NTSMC}$  at a steady state condition (in which the state variables are zero) is obtained from (25) in the following form:

$$u_T = u_{eq}^{NTSMC} = \frac{V_{ref}}{v_{in}}. \quad (25)$$

By adding  $u_{eq}$  and  $u$  obtained from (26), the total control law ( $u_T$ ) is obtained.

$$u = \frac{1}{2} (1 - \text{sign}(S)) = \begin{cases} 1, & S < 0 \\ 0, & S > 0. \end{cases} \quad (26)$$

#### B. Stability Analysis and Existence Condition for NTSMC

Existence condition for NTSMC is calculated from the below Lyapunov function and its derivation. Now, by derivation of (21),  $\dot{S}_n$  is calculated as follows:

$$\dot{S}_n = \dot{x}_1 + \frac{\lambda}{\gamma} \dot{x}_1^{\frac{1}{\gamma}-1} \dot{x}_1 = \dot{x}_2 + \frac{\lambda}{\gamma} \dot{x}_2^{\frac{1}{\gamma}-1}. \quad (27)$$

Therefore, the following two modes for zero and one state (switching OFF and ON) of the control input  $u$  are calculated:

$$\dot{S}_n = x_2 - \frac{\dot{\lambda}}{\gamma} x_2^{\frac{1}{\gamma}-1} \left[ \frac{x_2}{RC} - \omega_o^2 (v_{in} - V_{ref} - x_1) \right] > 0$$

for  $S < 0$ , when  $u = 1$  (28)

$$\dot{S}_n = x_2 - \frac{\dot{\lambda}}{\gamma} x_2^{\frac{1}{\gamma}-1} \left[ \frac{x_2}{RC} - \omega_o^2 (V_{ref} + x_1) \right] < 0$$

for  $S > 0$ , when  $u = 0$ . (29)

The above equations show the sliding mode dynamics for the closed-loop NTSMC control system. Combining these inequalities, the following relation is calculated:

$$\begin{aligned} \frac{\dot{\lambda}}{\gamma} x_2^{\frac{1}{\gamma}-1} \left[ \frac{x_2}{RC} - \omega_o^2 (v_{in} - V_{ref} - x_1) \right] &< x_2 \\ &< \frac{\dot{\lambda}}{\gamma} x_2^{\frac{1}{\gamma}-1} \left[ \frac{x_2}{RC} + \omega_o^2 (V_{ref} + x_1) \right]. \end{aligned} \quad (30)$$

By taking the two parts of the above inequalities to the power  $(1-1/\gamma)$ , the following relation in (31) can be obtained. The existence condition ( $S_n \dot{S}_n < 0$ ) is guaranteed if the condition in (31) holds:

$$-\omega_o^2 v_{in} < \frac{\dot{\lambda}}{\gamma} x_1^{2-\frac{1}{\gamma}} - \left[ \frac{x_2}{RC} + \omega_o^2 (V_{ref} + x_1) \right] < 0. \quad (31)$$

The sliding mode around the equilibrium point ( $x_1 \cong 0, x_2 \cong 0$ ) would exist if the following equation for the buck DC-DC converter parameter are established [34]:

$$-\omega_o^2 v_{in} < -\omega_o^2 V_{ref} < 0. \quad (32)$$

Non-singular terminal sliding mode control tackles the problem of singularity in the terminal sliding mode control method. One problem of NTSMC method is that its design is more complex than that of the other methods mentioned so far. Besides, in this method, the value of  $\gamma$  parameter, to ensure the stability of the system, has a restriction  $0.5 < \gamma < 1$  which leads to losing some of the desired dynamic response during the load resistance disturbances. The lower the value of this parameter, the faster the buck converter response reaches the equilibrium point, though here it could not have a value lower than 0.5.

## VII. EXPERIMENTAL SET-UP, EXPERIMENTAL AND SIMULATION TESTS

In order to represent the performance of the sliding mode strategies, the DC-DC buck converter has been tested by experiments and simulations. Experimental results were obtained from a hardware setup constructed in a laboratory. A buck converter prototype is shown in Fig. 4.

The switching pulse was performed by means of a MOSFET transistor (IRFP150M), as shown in Fig. 5 with an isolation circuit based on a high-speed opto-coupler (6N137). It is necessary to isolate the input signal in the control algorithm of the input signal in the power MOSFET transistor. The isolation circuit is also depicted in Fig. 6.

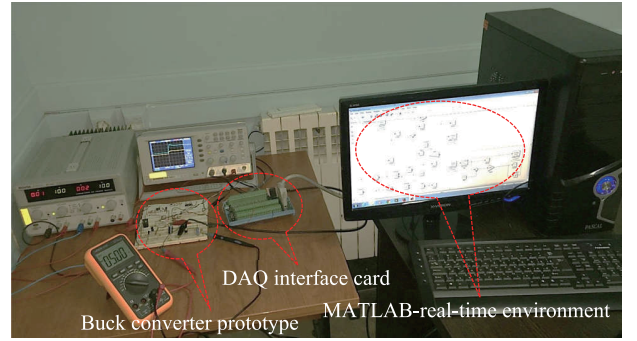

Fig. 4. Experimental prototype.

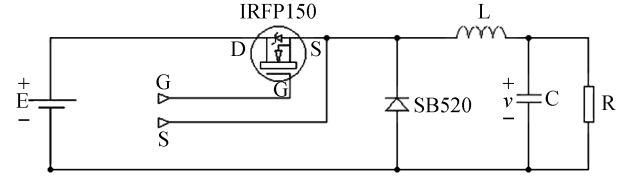

Fig. 5. Experimental implementation of the buck converter.

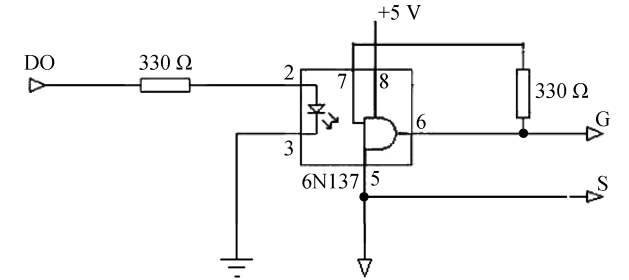

Fig. 6. Opto-coupler isolation circuit of PC to power switches (IRFP150M).

A computer (Pentium IV, with 2.8 GHz speed, 1.24 GB RAM) is used to perform the proposed second order sliding mode controller with twisting algorithm. The proposed controller was implemented in the real-time-MATLAB environment.

The communication between the buck converter circuit and the proposed second-order sliding mode controller was implemented by DAQ-Advantech, PCI-1716 AE, a data acquisition card (Model: PCI-1716 AE, 16-Channel, high-resolution, 16 bit, multifunction, 250 kHz in speed and 0.03% of accuracy) which is used to connect the buck circuit and computer. Operating range of the card is  $\pm 10$  V for input data. A voltage conditioning circuit including a scaling of the capacitor voltage, besides an operational amplifier isolation module was implemented for voltage sensing and a scaling factor of was used. The voltage conditioning circuit is connected to analog input ( $AI_0$ ) of DAQ-Advantech.

The voltage measurement circuit is shown in Fig. 7. The current measurement was measured by a shunt resistor  $0.003 \Omega$  and the differential coupling is sketched in Fig. 8. The interesting part of this coupling is that it amplifies the voltage of shunt resistor without reference to ground. This operational amplifier module was implemented for current measurement.

The current measurement circuit is connected to analog input ( $AI_2$ ) of DAQ-Advantech. A digital output ( $DO_0$ ) is

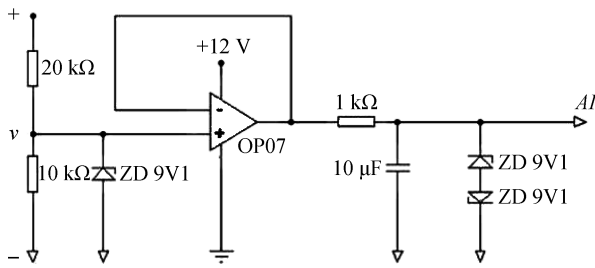

Fig. 7. Voltage measurement circuit as a feedback.

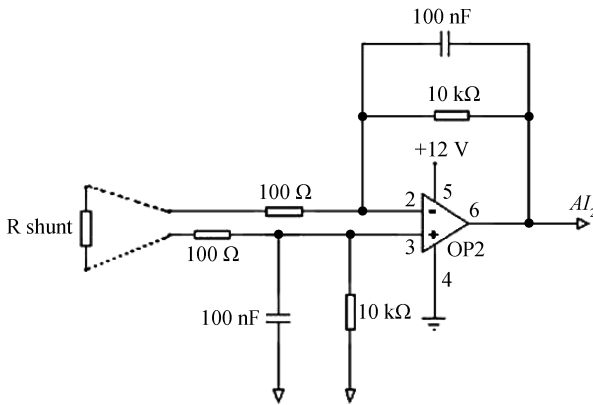

Fig. 8. Current measurement circuit as a feedback.

used to implement the PWM pulse of control signal to opto-isolation circuit and then to MOSFET transistor. The interconnection of the modules can be appreciated in a block diagram form as depicted in Fig. 9.

*A. Experimental and Simulation Results*

In this section, the performance of the NTSMC controller with parameters  $h = 0.02$ ,  $\lambda = 100$  and  $\gamma = 3$  is examined. Fig. 10 shows the simulated start-up response of the equivalent control input. Fig. 10 shows the control input ( $u$ ), the output voltage ( $v_o$ ), the inductor current ( $i_L$ ) and state variables, i.e., output voltage error ( $x_1$ ) and the rate of change of the output voltage error ( $x_2$ ) while NTSMC method is applied for  $R = 2 \Omega$ . It is clear that  $v_o$  is in good agreement with the simulation result shown in Fig. 10(a). Inductor current is shown in Fig. 10(b) and  $x_1$  and  $x_2$  have the same results as the simulation results in Figs. 10(c) and (d), respectively.

Experimental results with NTSMC method are shown in Fig. 11, where Fig. 11(a) shows output voltage and output voltage error while Fig. 11(b) shows switching pulse and output voltage error.

The block diagram of the simulated SOSMC controller via twisting algorithm for buck converter in MATLAB-real-time environment can be seen in Fig. 12. Fig. 13 shows the output voltage, the inductor current, and output voltage error for the buck converter controlled by SOSMC using twisting algorithm. The corresponding control parameters are shown in Table II.

TABLE II  
PARAMETERS OF TWISTING METHOD SLIDING MODE CONTROL

Parameter	Nominal value
$\alpha_1$	9.6
$\alpha_2$	0.8

As shown in Fig. 13, the output voltage diagram at the start-up moment has an overshoot that reaches up to 7 volts. The diagram of inductor current fluctuates between 0 to 1mA. The diagram for control input shown in Fig. 14 also indicates the  $u$  signal, which is applied to the Sw switch in buck converter. It is to some extent more continuous than first order sliding mode methods, leading to a reduction in vibration problem.

Fig. 15 depicts the phase plane  $S(t)$  and  $S'(t)$  of the twisting algorithm which confirms the fact that  $S(t)$  and  $S'(t)$  converge to zero.

Fig. 16 shows the experimental responses of  $x_1$ ,  $u$  and  $v_o$  with twisting algorithm for the case that is considered in Figs. 13 and 14.

*B. Comparison of Algorithm Under Different Condition*

In this section, all control methods such as SMC, ASMC and NTSMC with second order sliding mode control level via twisting algorithm are compared on the buck converter in the following four aspects: 1) startup response, 2) perturbation of load resistance, 3) perturbation of the input voltage ( $v_{in}$ ) and 4) changes in the desired output voltage ( $V_{ref}$ ). According to comparison, it is considered that twisting algorithm has better performance than other algorithms. In tracking time response and steady state error, SMC and ASMC are the worst ones. But in disturbance rejection, twisting algorithms and ASMC are the best ones.

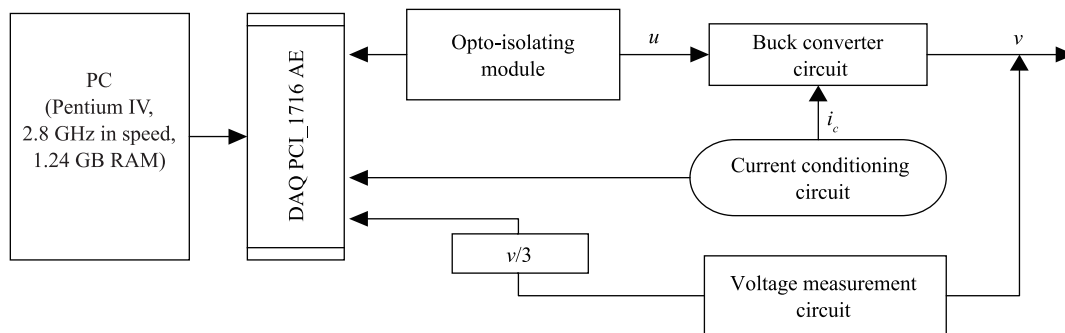

Fig. 9. Block diagram of implemented control system of the buck converter.

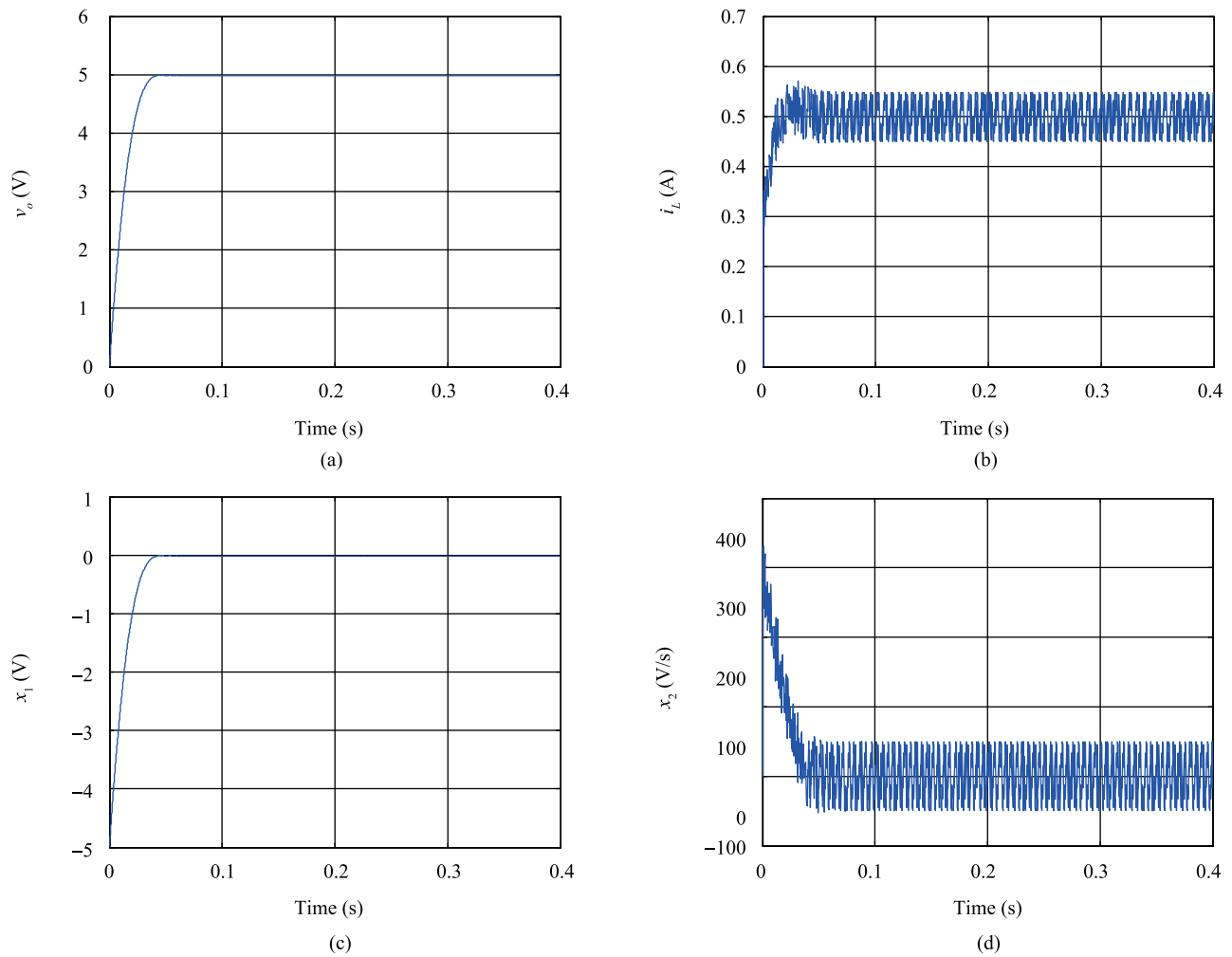

Fig. 10. Simulation results of a DC-DC buck converter. (a) Output voltage. (b) Inductor current. (c) Output voltage error ( $x_1$ ). (d) Output voltage error rate ( $x_2$ ) with NTSMC method.

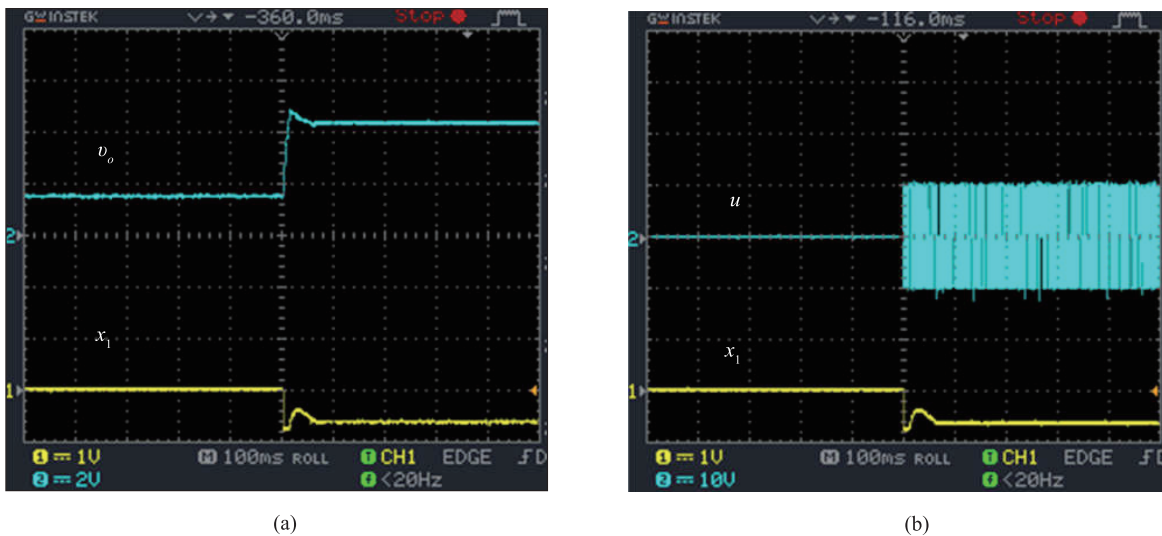

Fig. 11. Experimental results. (a) Output voltage and output voltage error. (b) Switching pulse and output voltage error with NTSMC method.

Fig. 17 depicts the simulated output voltage in startup response. As can be seen in this figure, the startup response for twisting method is faster than SMC, ASMC and NTSMC methods, while SOSMC response has a relatively big overshoot in the initial moments which is undesirable while other

methods do not have an overshoot or its value is very little.

Settling time for each method of sliding mode is shown in Table III. From the table it can be seen that SOSMC method via twisting algorithm is faster than the SMC methods, i.e., NTSMC, ASMC and SMC. Fig. 18 shows the experimental



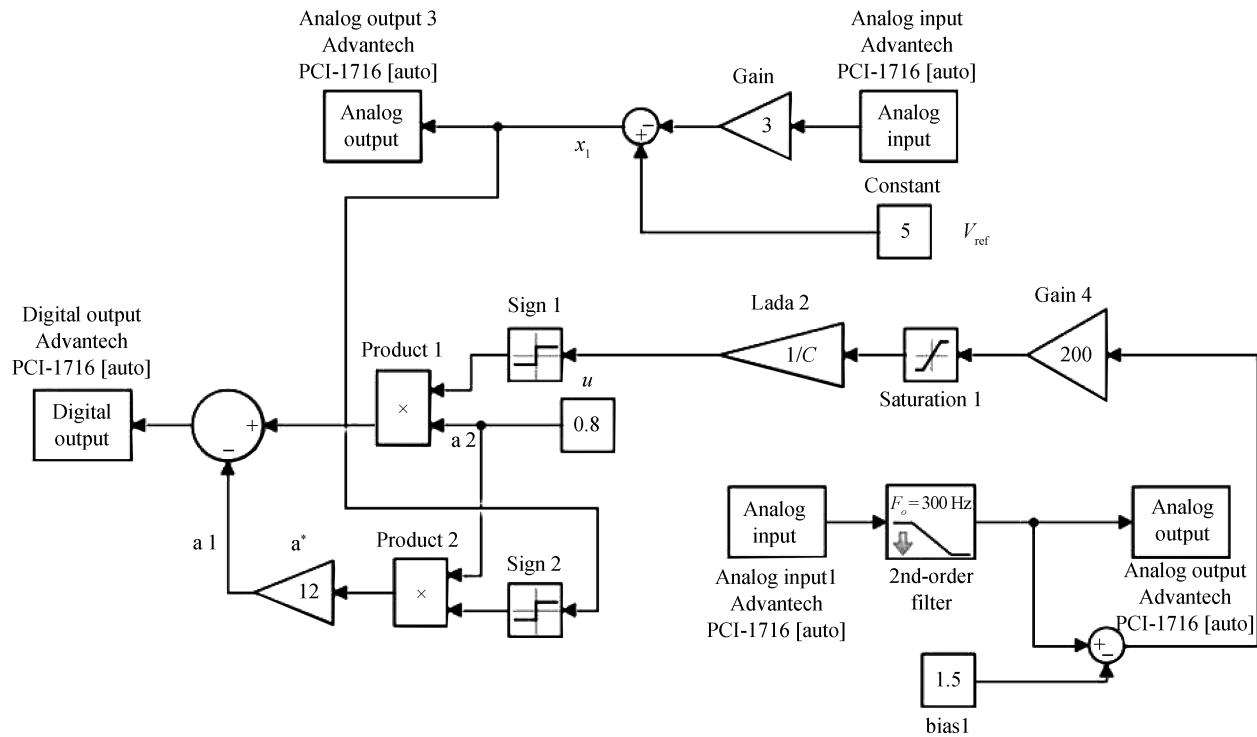

Fig. 12. MATLAB-real-time environment of buck converter controlled by a twisting algorithm.

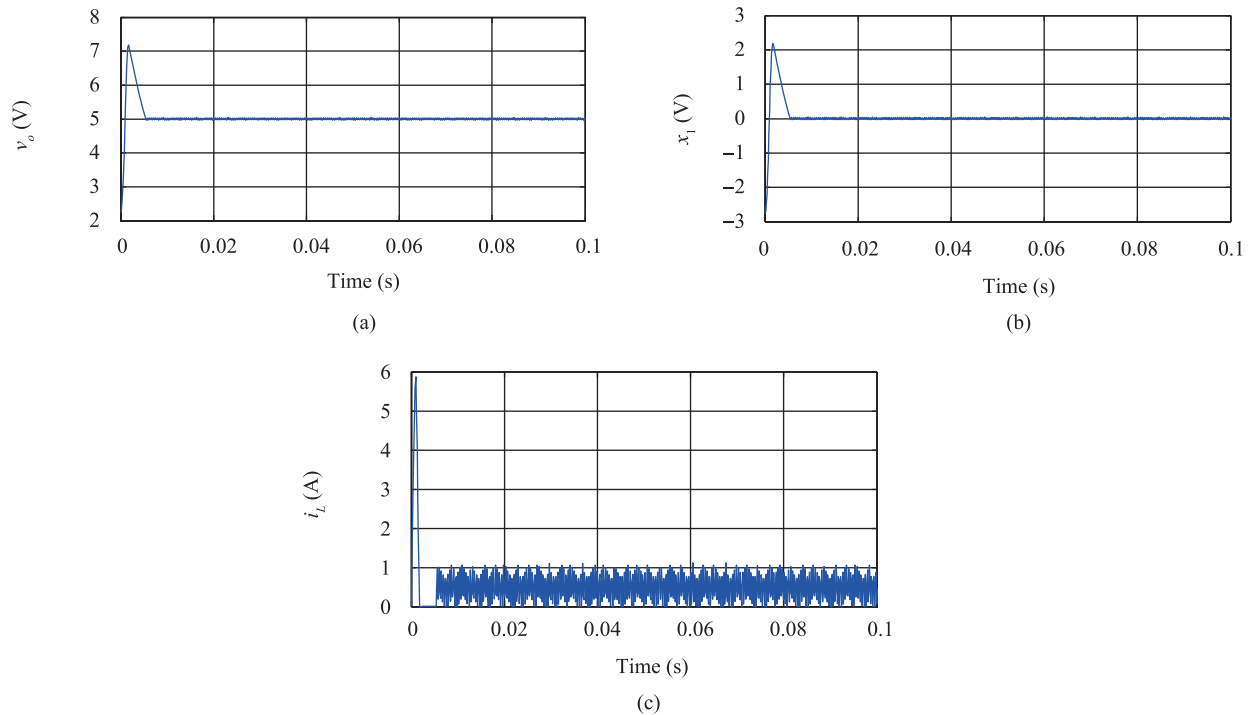

Fig. 13. Simulation results of a DC-DC buck converter controlled by twisting algorithm. (a) Output voltage. (b) Error of output voltage. (c) Inductor current.

responses of  $v_o$  with twisting algorithm and NTSMC method.

In tracking by NTSMC method, an error of about 0.6 volts can be seen in Fig. 19(a), but twisting algorithm has an accurate tracking and the error has come down to zero (Fig. 19(b)).

C. Step Changes in the Load as Disturbance

Simulation diagrams for output voltage in Fig. 20 are provided for all methods while load resistance is decreasing from

$10\Omega$  to  $2\Omega$  at the moment  $t = 0.2$ s. ASMC method is more efficient than SMC, TSMC and twisting algorithm only when load resistance is changing. This is due to the adjustment of  $\lambda$  parameter based on the changes in load resistance. The  $\lambda$  parameter is a function of  $R_L$ .

In twisting method by reducing the load resistance, steady state error tolerance increases, which is undesirable. On the other hand, undershoots for all sliding mode control methods presented in Fig. 20 are almost identical. Therefore, only

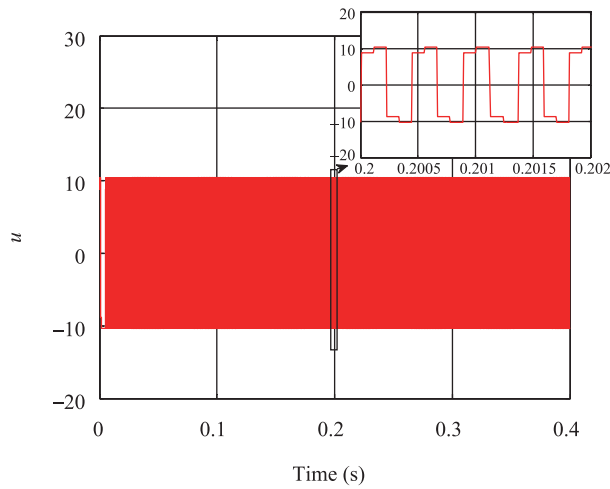

Fig. 14. Control input of the buck converter controlled twisting algorithm.

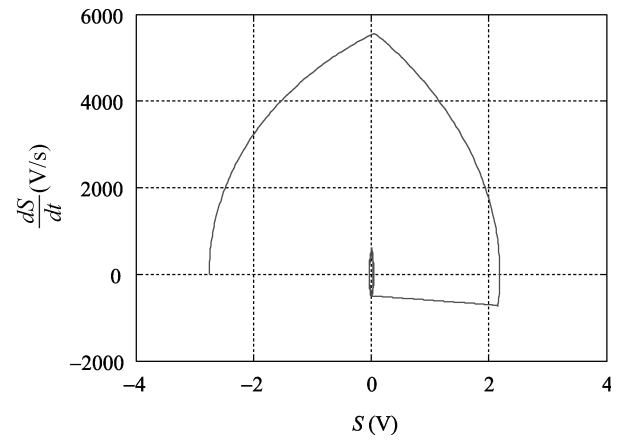
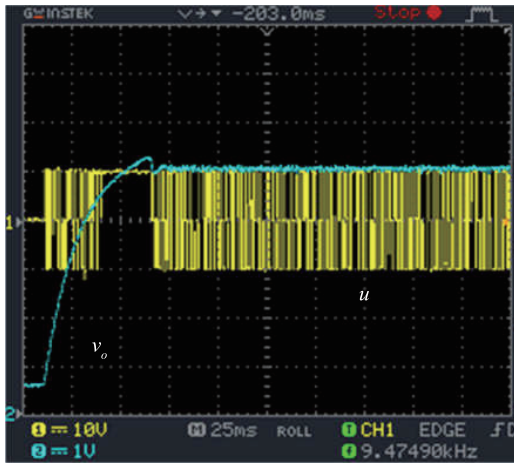
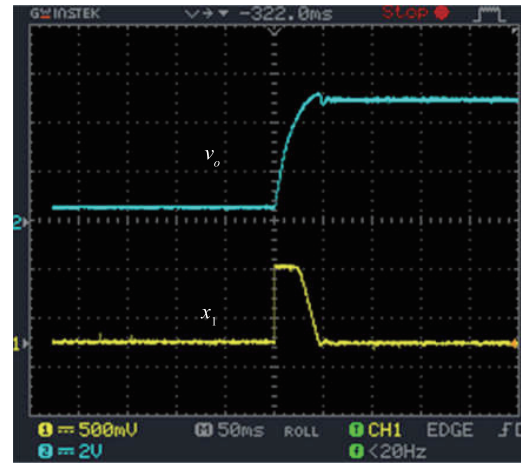

Fig. 15. Phase portrait of the buck converter controlled by twisting algorithm.



(a)



(b)

Fig. 16. Experimental result of (a) switching pulse and output voltage and (b) output voltage and output voltage error by twisting algorithm.

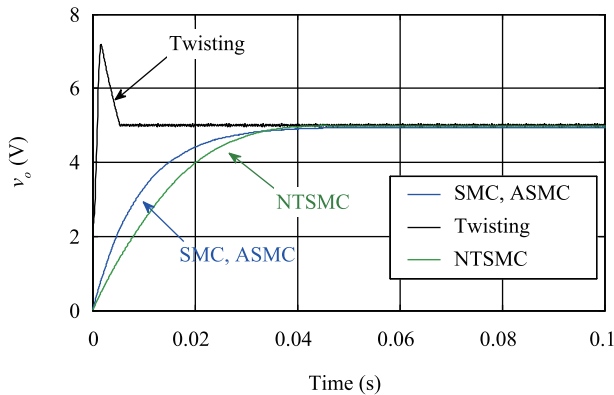

Fig. 17. Output voltages through different sliding mode methods.

settling times during load resistance changes are compared quantitatively in Table III.

However, practical implementation of non-adaptive controllers leads to reduction in the cost and measurement equip-

ment compared to the adaptive method.

#### D. Changes in Input Voltage as Disturbance

The simulation diagrams of output voltage in Fig. 21 are provided for all methods while the input voltage is declining from 10V to 8V at the moment  $t = 0.2$ s. Due to the dependence of ATSMC method to load resistance  $R_L$ , the controller shows a robust behavior against drastic changes of the load current. However, its response during the disturbance of input voltage is exactly equal to those of the non-adaptive method. As can be seen in Fig. 21 and Table III, twisting methods have the lowest steady-state error during changes in the input voltage. In twisting method by changing the input voltage, error tolerance increases which is undesirable.

By comparing the quantitative methods of analyzing steady-state error while disturbances of the input voltage of the buck converter are active, it could be concluded that twisting method

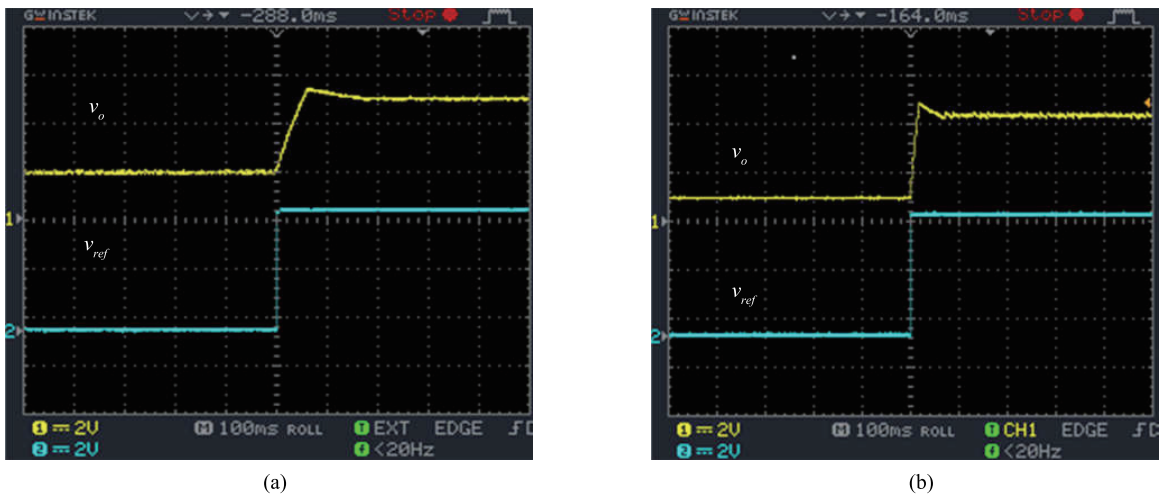

Fig. 18. Output voltages. (a) Twisting algorithm. (b) NTSMC method.

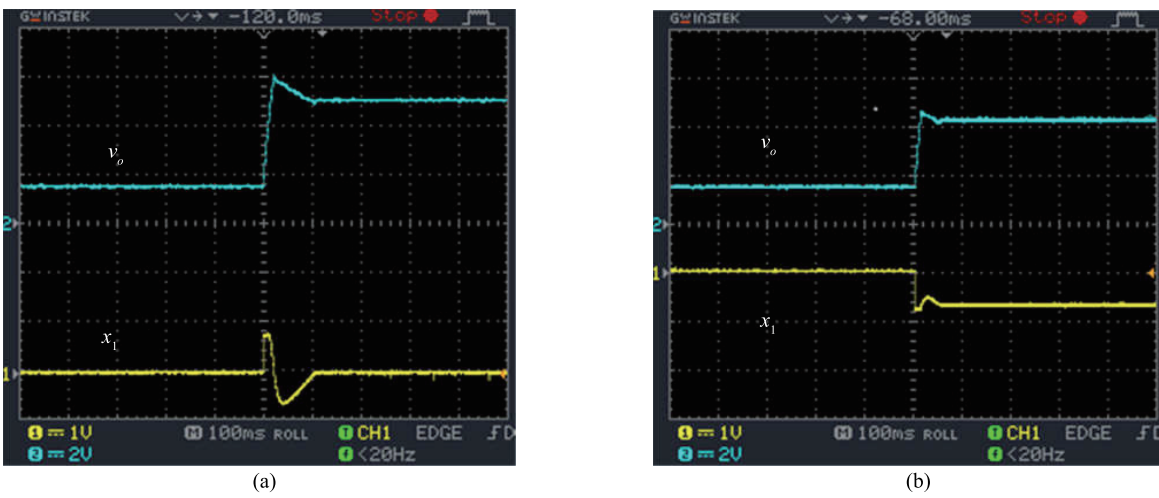

Fig. 19. Experimental result of  $v_o$  and output voltage error ( $x_1$ ) for startup response. (a) Twisting algorithm. (b) NTSMC method.

TABLE III  
COMPARISONS OF OUTPUT VOLTAGE FOR FOUR CONTROL METHODS OF SLIDING MODE ALGORITHMS

Control method	Settling time (ms) of start-up response	Settling time (ms) of changes in the load resistance ( $R_L$ : $10\Omega$ to $2\Omega$ )	Steady-state error (mv) for changes in input voltage ( $v_{in}$ : $10\text{V}$ to $8\text{V}$ )	Tracking time (ms) of changes in desired output voltage ( $V_{ref}$ : $5\text{V}$ to $7\text{V}$ )
SMC	35	30	100	45
ASMC	35	10	100	45
NTSMC	33	16	61	31
Twisting	5	8	2	3

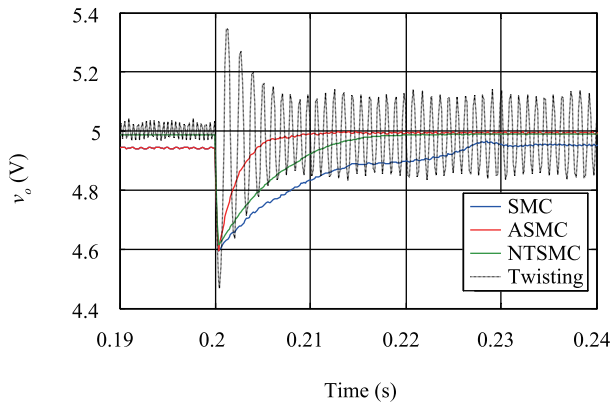

Fig. 20. The output voltage diagrams by different sliding mode methods during changes in load resistance from  $10\Omega$  to  $2\Omega$  at  $t = 0.2\text{s}$ .

has the lowest error. Thus, twisting method response is more robust in presence of disturbances in input voltage while SMC and ASMC have the highest steady-state error. Among the first-order sliding mode control methods with a simpler SMC design, NTSMC method has the lowest error rate.

Experimental responses of the output voltage obtained by twisting method for changes in  $v_{in}$  from  $10\text{V}$  to  $12\text{V}$  and from  $12\text{V}$  to  $10\text{V}$  are shown in Fig. 22. The output voltage takes about  $50\text{ms}$  to track its reference that agrees well with the simulation result of the same case shown in Fig. 21(a).

### E. Changes in Reference Output Voltage

In Fig. 23, simulation diagrams of output voltage and its error ( $x_1$ ) for all methods is depicted when the desired output

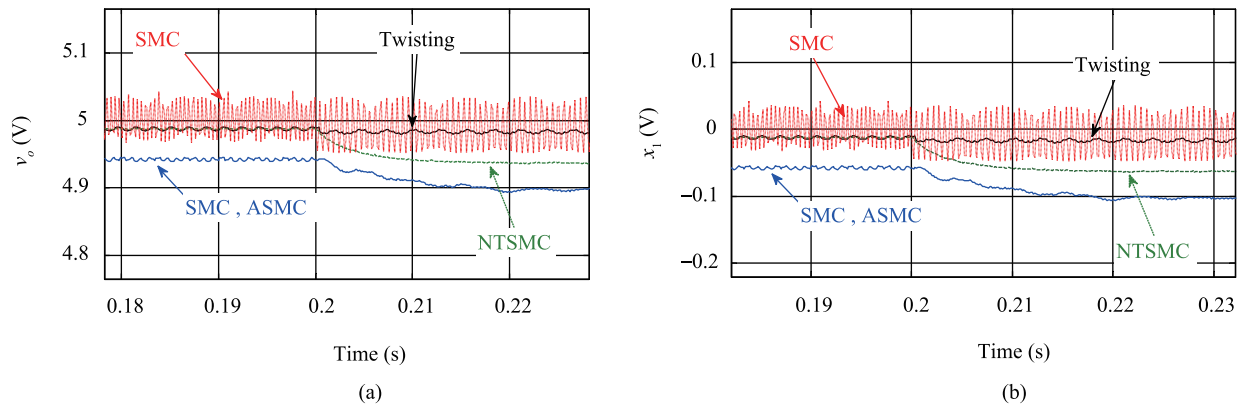

Fig. 21. (a) Output voltage and (b) output voltage error ( $x_1$ ) by different sliding mode methods with disturbance in input voltage at  $t = 0.2$  s.

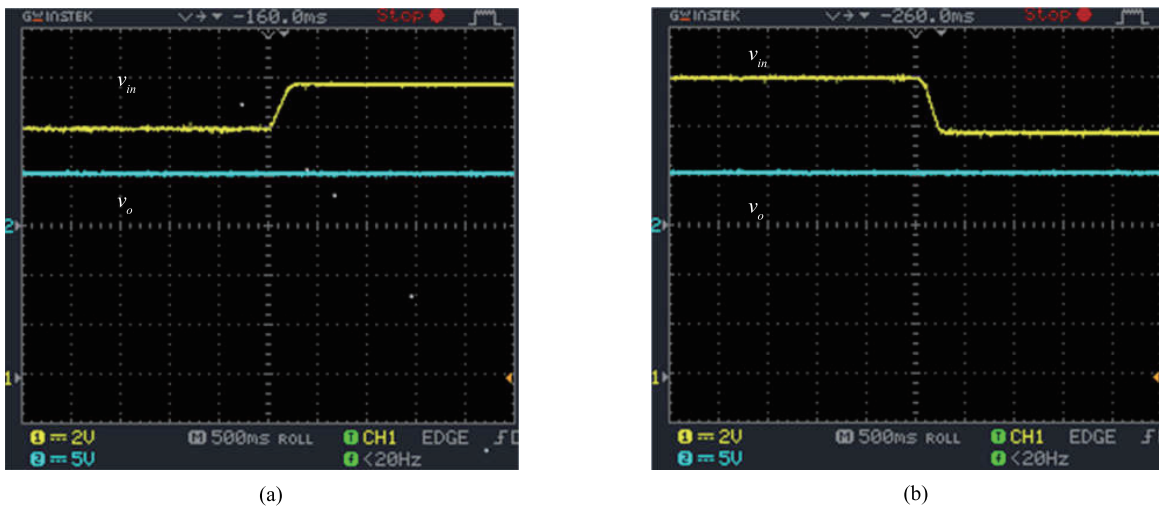

Fig. 22. Experimental response of the output voltage by twisting method for a change in  $v_{in}$  from (a) 10 V to 12 V and (b) 12 V to 10 V.

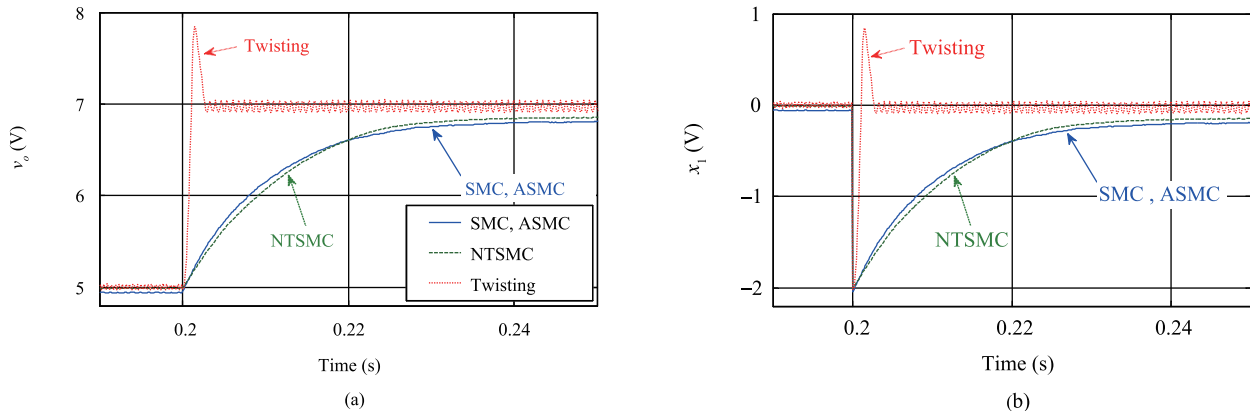

Fig. 23. (a) Output voltage and (b) output voltage error ( $x_1$ ) by different sliding mode methods during disturbance in reference voltage ( $V_{ref}$ ) at  $t = 0.2$  s.

voltage ( $V_{ref}$ ) is increased from 5 V to 7 V at  $t = 0.2$  s. As seen in this figure and Table III, tracking the output voltage by SOSMC methods is much faster and has a higher precision than SMC methods. However, in twisting algorithm, during changes in desired output voltage, there is some overshoot too. Among SMC methods, NTSMC has the shortest tracking time. Since the accuracy of tracking for four methods is almost the same, the tracking time is examined quantitatively in Table III.

Fig. 23 and Fig. 24 show the simulated and experimental responses of the output voltage obtained by NTSMC and

twisting method for a step change in  $V_{ref}$  from 5 V to 7 V at  $t = 0.2$  s. It is obvious that when the step change occurs, the switch stays ON until the inductor current reaches to its desired steady-state value. Then, when the desired steady state is reached, the switch is turned OFF and ON, continuously, keeping the converter in the new operating point. The result shown in Figs. 23(a) and (b) are in close agreement with the experimental result shown in Fig. 24(a).

Fig. 25 shows the output voltage and its error while the input voltage changes from 5 V to 7 V. And also the Fig. 25 indicates that the twisting algorithm has a desired tracking against

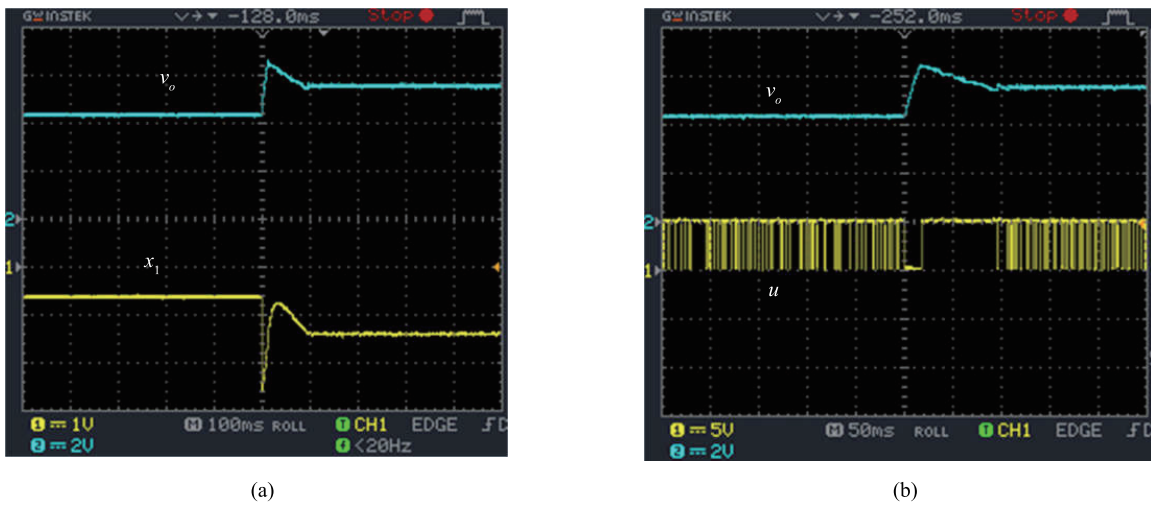

Fig. 24. Experimental response. (a)  $v_o$  and output voltage error. (b)  $v_o$  and the control input ( $u$ ) for a change in  $V_{ref}$  from 5 V to 7 V by NTSMC.

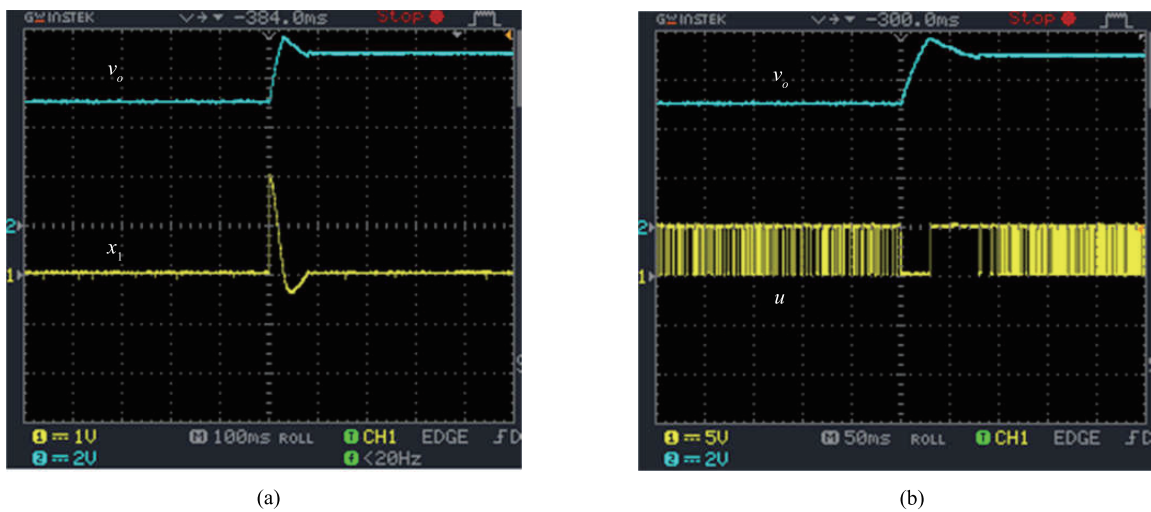

Fig. 25. Experimental response. (a)  $v_o$  and output voltage error. (b)  $v_o$  and the control input for a change in  $V_{ref}$  from 5 V to 7 V by twisting algorithm.

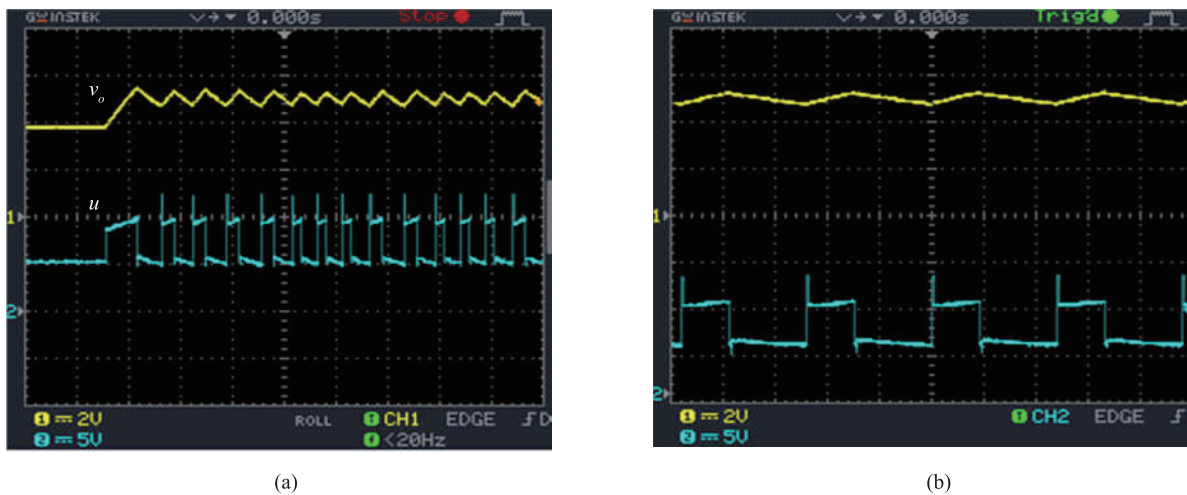

Fig. 26. Chattering effect. (a) Output voltage and switching pulse to MOSFET. (b) Zoomed shape of output voltage and switching pulse by SMC method.

changes of the reference voltage. In addition, Fig. 25 shows that the experimental results are similar as in Fig. 23.

*F. Chattering Effect*

The main obstacle for sliding mode control implementation is chattering phenomenon or ripples in power converter. Due

to high level of heat losses in power converters at high switching frequency, the conventional methods of chattering suppression are not applicable. The second-order sliding mode control, compared to conventional SMC has the advantage that it provides a smooth control law and better efficiency in the control implementation yielding less chattering and

better convergence accuracy while preserving the robustness properties. The main idea is to reduce to zero, not only the sliding surface, but also the second derivative of the sliding surface.

The experimental responses of output voltage with sliding mode control are shown in Fig. 26. One can easily see that Figs. 26(a) and (b) show fluctuation in tracking of output voltage. The chattering phenomena is due to the inclusion of the sign function in the switching term and it can cause the control input to start fluctuation while sliding surface reaches zero, resulting in unwanted wear and tear of the actuators.

In Fig. 27, chattering effect of output voltage and switching pulse to MOSFET by twisting method are shown. It provides better performance in the control implementation yielding less chattering and better convergence accuracy while preserving the robustness properties. The main idea is to reduce to zero, not only the sliding surface, but also its second-order derivative. It means that the second-order sliding mode corresponds to the control acting on the second derivative of the sliding surface.

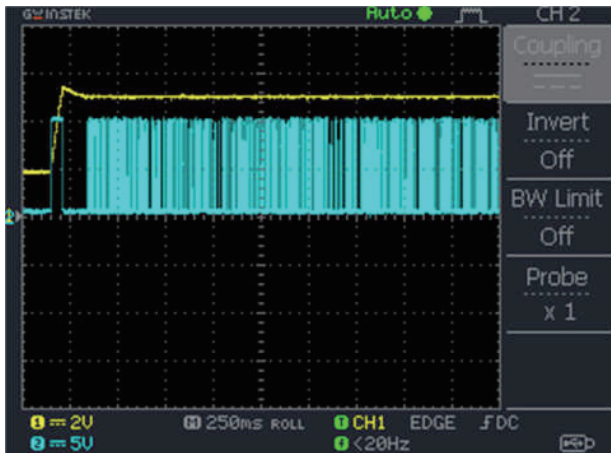

Fig. 27. Chattering effect of output voltage and switching pulse to MOSFET by twisting method.

### G. Quantitative Comparison

The numerical values of parameters in each case are presented in Table IV in order to have a quantitative comparison of different sliding mode methods in various operating conditions of buck converter discussed in this section.

## VIII. CONCLUSION

In this paper, a second-order sliding mode control with twisting algorithm is proposed for DC-DC buck converter. Twisting algorithm of second order sliding mode was compared with different first order sliding mode controls such as adaptive sliding mode control, non-singular terminal sliding mode algorithms to control DC-DC buck converter. Adaptive sliding mode control is proposed to optimize the transient response, which shows better performance during load changing rather than sliding mode algorithm. The NTSMC employs a nonlinear sliding surface function that assures finite time convergence of the output voltage to the reference voltage.

Equivalent control approach is used in NTSMC method and stability of the closed-loop system is proved using direct Lyapunov approach. And also, steady state error of the output voltage was reduced in presence of input voltage disturbance. The new nonlinear sliding surface avoids singularity problem.

The closed-loop system is also implemented in an experimental application of a DC-DC buck converter. In this paper, the results have shown that the ASMC algorithm can improve the dynamic performance of the converter during disturbances. In addition to robustness, NTSMC method is applied to ensure finite time convergence in the output voltage with respect to reference voltage output without the singularity problem. Finally, simulations and experimental results from a test prototype are compared for different operating points. Twisting method presents efficient performance in dealing with steady state error and settling time of the output voltage in presence of load disturbances.

## REFERENCES

- [1] H. Komurcugil, "Adaptive terminal sliding-mode control strategy for DC-DC buck converters," *ISA Trans.*, vol. 51, no. 6, pp. 673–681, Nov. 2012.
- [2] S. C. Tan, Y. M. Lai, and C. K. Tse, "A unified approach to the design of PWM-based sliding-mode voltage controllers for basic DC-DC converters in continuous conduction mode," *IEEE Trans. Circ. Syst. I Reg. Pap.*, vol. 53, no. 8, pp. 1816–1827, Aug. 2006.
- [3] V. Utkin, "Sliding mode control of DC/DC converters," *J. Franklin Inst.*, vol. 350, no. 8, pp. 2146–2165, Oct. 2013.
- [4] I. Boiko, L. Fridman, R. Iriarte, A. Pisano, and E. Usai, "Parameter tuning of second-order sliding mode controllers for linear plants with dynamic actuators," *Automatica*, vol. 42, no. 5, pp. 833–839, May 2006.
- [5] J. Davila, L. Fridman, and A. Levant, "Second-order sliding-mode observer for mechanical systems," *IEEE Trans. Automat. Control*, vol. 50, no. 11, pp. 1785–1789, Nov. 2005.
- [6] G. Bartolini, A. Ferrara, and E. Usai, "Applications of a sub-optimal discontinuous control algorithm for uncertain second order systems," *Int. J. Robust Nonlinear Control*, vol. 7, no. 4, pp. 299–319, Apr. 1997.
- [7] G. Bartolini, A. Ferrara, E. Usai, and V. I. Utkin, "On multi-input chattering-free second-order sliding mode control. Institute of Electrical and Electronic Engineers," *IEEE Trans. Automat. Control*, vol. 45, no. 9, pp. 1711–1717, Sep. 2000.
- [8] Y. Feng, X. H. Yu, and Z. H. Man, "Non-singular terminal sliding mode control of rigid manipulators," *Automatica*, vol. 38, no. 12, pp. 2159–2167, Dec. 2002.
- [9] S. H. HosseinNia, I. Tejado, B. M. Vinagre, and D. Sierociuk, "Boolean-based fractional order SMC for switching systems: application to a DC-DC buck converter," *Signal Image Video Process.*, vol. 6, no. 3, pp. 445–451, Sep. 2012.
- [10] S. H. HosseinNia, D. Sierociuk, A. J. Calderón, and B. M. Vinagre, "Augmented system approach for fractional order SMC of a DC-DC Buck converter," in *Proc. 4th IFAC Workshop on Fractional Differentiation and Its Applications*, Badajoz, Spain, 2010.
- [11] S. H. HosseinNia and B. M. Vinagre, "Direct Boolean integer and fractional order SMC of switching systems: Application to a DC-DC buck converter," in *Proc. 4th IFAC Workshop on Fractional Differentiation and Its Applications*, Badajoz, Spain, 2010.
- [12] S. C. Tan, Y. M. Lai, and C. K. Tse, "General design issues of sliding-mode controllers in DC-DC converters," *IEEE Trans. Ind. Electron.*, vol. 55, no. 3, pp. 1160–1174, Mar. 2008.

- [13] S. C. Tan, Y. M. Lai, and C. K. Tse, "Indirect sliding mode control of power converters via double integral sliding surface," *IEEE Trans. Power Electron.*, vol. 23, no. 2, pp. 600–611, Mar. 2008.
- [14] J. F. Tsai and Y. P. Chen, "Sliding mode control and stability analysis of buck DC-DC converter," *Int. J. Electron.*, vol. 94, no. 3, pp. 209–222, Feb. 2007.
- [15] S. C. Tan, Y. M. Lai, M. K. H. Cheung, and C. K. Tse, "On the practical design of a sliding mode voltage controlled buck converter," *IEEE Trans. Power Electron.*, vol. 20, no. 2, pp. 425–437, Mar. 2005.
- [16] S. C. Tan, Y. M. Lai, C. K. Tse, and M. K. H. Cheung, "Adaptive feed-forward and feedback control schemes for sliding mode controlled power converters," *IEEE Trans. Power Electron.*, vol. 21, no. 1, pp. 182–192, Jan. 2006.
- [17] G. Bartolini, A. Pisano, E. Punta, and E. Usai, "A survey of applications of second-order sliding mode control to mechanical systems," *Int. J. Control*, vol. 76, no. 9–10, pp. 875–892, Jun. 2003.
- [18] A. Cavallo and C. Natale, "High-order sliding control of mechanical systems: Theory and experiments," *Control Eng. Pract.*, vol. 12, no. 9, pp. 1139–1149, Sep. 2004.
- [19] N. Vazquez, C. Hernandez, J. Alvarez, and J. Arau, "Sliding mode control for DC/DC converters: A new sliding surface," in *Proc. IEEE Int. Symp. Industrial Electronics*, Rio de Janeiro, Brazil, 2003, pp. 422–426.
- [20] H. Sira-Ramirez, "Sliding mode  $\Delta$  modulation control of a 'buck' converter," in *Proc. 42nd IEEE Conf. Decision and Control*, Maui, HI, USA, 2003, pp. 2999–3004.
- [21] M. Bensaada and A. Boudghene Stambouli, "A practical design sliding mode controller for DC-DC converter based on control parameters optimization using assigned poles associate to genetic algorithm," *Int. J. Electr. Power Energy Syst.*, vol. 53, pp. 761–773, Dec. 2013.
- [22] S. C. Tan, Y. M. Lai, and C. K. Tse, "Indirect sliding mode control of power converters via double integral sliding surface," *IEEE Trans. Power Electron.*, vol. 23, no. 2, pp. 600–611, Mar. 2008.
- [23] M. J. Jafarian and J. Nazarzadeh, "Time-optimal sliding-mode control for multi-quadrant buck converters," *IET Power Electron.*, vol. 4, no. 1, pp. 143–150, Jan. 2011.
- [24] E. Fossas and A. Ras, "Second-order sliding-mode control of a buck converter," in *Proc. 41st IEEE Conf. Decision and Control*, Las Vegas, NV, USA, 2002, pp. 346–347.
- [25] H. Komurcugil, "Adaptive terminal sliding-mode control strategy for DC-DC buck converters," *ISA Trans.*, vol. 51, no. 6, pp. 673–681, Nov. 2012.
- [26] J. Baek and M. Park, "Fuzzy bilinear state feedback control design based on TS fuzzy bilinear model for DC-DC converters," *Int. J. Electr. Power Energy Syst.*, vol. 42, no. 1, pp. 710–720, Nov. 2012.
- [27] J. X. Liu, S. Laghrouche, M. Harmouche, and M. Wack, "Adaptive-gain second-order sliding mode observer design for switching power converters," *Control Eng. Pract.*, vol. 30, pp. 124–131, Sep. 2014.
- [28] J. X. Liu, S. Laghrouche, and M. Wack, "Observer-based higher order sliding mode control of power factor in three-phase AC/DC converter for hybrid electric vehicle applications," *Int. J. Control*, vol. 87, no. 6, pp. 1117–1130, Feb. 2014.
- [29] N. Mohan, T. M. Undeland, and W. P. Robbins, *Power Electronics: Converters, Applications, and Design*. 3rd ed. New York, USA: Wiley, 2003.
- [30] H. Komurcugil, "Non-singular terminal sliding-mode control of DC-DC buck converters," *Control Eng. Pract.*, vol. 21, no. 3, pp. 321–332, Mar. 2013.
- [31] V. I. Utkin, *Sliding Modes in Control and Optimization*. Berlin Heidelberg, Germany: Springer-Verlag, 1992.
- [32] L. Fridman and A. Levant, "Higher-order sliding modes," in *Sliding Mode Control in Engineering*, W. Perruquetti and J. P. Barbot, Eds. New York, USA: Marcel Dekker, 2002, pp. 53–101.
- [33] A. Levant, "Sliding order and sliding accuracy in sliding mode control," *Int. J. Control*, vol. 58, no. 6, pp. 1247–1263, Dec. 1993.
- [34] A. Levant, "Higher-order sliding modes, differentiation and output-feedback control," *Int. J. Control*, vol. 76, no. 9–10, pp. 924–941, Sep. 2003.
- [35] J. A. Moreno and M. Osorio, "A Lyapunov approach to second-order sliding mode controllers and observers," *Proc. 47th IEEE Conf. Decision and Control*, Cancun, Mexico, 2008, pp. 2856–2861.
- [36] G. Bartolini, A. Ferrara, A. Pisano, and E. Usai, "On the convergence properties of a 2-sliding control algorithm for non-linear uncertain systems," *Int. J. Control*, vol. 74, no. 7, pp. 718–731, May 2001.
- [37] M. Nachidi, A. El Hajjaji, and J. Bosche, "An enhanced control approach for DC-DC converters," *Int. J. Electr. Power Energy Syst.*, vol. 45, no. 1, pp. 404–412, Feb. 2013.



**Seyed Mehdi RakhtAla** received the Ph.D. degree from the Electrical Engineering Department with specialization in automatic control: application in renewable energy from Mazandran University in 2012. His main research interests include renewable energy system design and control (specializing in fuel cell), nonlinear control, sliding mode control. During 2004–2008, he was Head of electrical group in the Fuel Cell Research Center of Mazandran University. Currently he is an Assistant Prof. of Golestan University at Department of Electrical Engineering.



**Monazzahalsadat Yasoubi** received the B.S. degree in electronics engineering from Kerman Islamic Azad University, Kerman, Iran in 2008, and the M.S. degree in control engineering from the Babol Noshirvani University of Technology, Babol, Iran in 2013.

Currently, she is a Ph.D. candidate in electrical and computer engineering at Concordia University, Montreal, QC, Canada. Her research interests include wireless communications including information theory, and evolutionary algorithms.



**Hassan HosseinNia** received the Ph.D. degree with honor in electrical engineering specializing in automatic control: application in mechatronics, from University of Extremadura, Spain in 2013. He has industrial experience of working as an R&D researcher at ABB, Sweden. Currently he is an Assistant Professor in the Department of Precision and Microsystem Engineering at TU Delft, The Netherlands. His main research interests include mechatronic system design and precision motion control using fractional-order control, hybrid control, model predictive control, and iterative learning control. He has published more than 80 papers in international conferences, journals, special issues, and book chapters.