

## RESEARCH ARTICLE

# Three-Dimension Digital Twin Reference Architecture Model for Functionality, Dependability, and Life Cycle Development Across Industries

SEBASTIAN RICHARD NEWRZELLA<sup>1,2</sup>, DAVID W. FRANKLIN<sup>1,3</sup>, (Member, IEEE), AND SULTAN HAIDER<sup>1,2</sup>

<sup>1</sup>Department of Sport and Health Sciences, Technical University of Munich, 80992 Munich, Germany

<sup>2</sup>Innovation Think Tank, Siemens Healthcare GmbH, 91058 Erlangen, Germany

<sup>3</sup>Munich Institute of Robotics and Machine Intelligence (MIRMI), Technical University of Munich, 80992 Munich, Germany

Corresponding author: Sebastian Richard Newrzella (sebastian.newrzella@siemens-healthineers.com)

This work was supported by Innovation Think Tank, Siemens Healthcare GmbH, Germany.

**ABSTRACT** The Digital Twin concept promises numerous applications across industries and its physical twin's entire life cycle. Although numerous architectures have been proposed to develop and describe the setup of Digital Twin applications, current Digital Twin architectures do not address the versatile cross-industry character of the Digital Twin concept, its safety, security, and privacy aspects, and are often use case-specific and inflexible. We propose a three-dimensional Digital Twin reference architecture model for application across industries, considering functionality, dependability, and life cycle aspects. Our model provides practitioners a common platform to develop and discuss Digital Twin applications of different complexities and dependability aspects along varying life cycles and independent of the industry. Its applicability is validated and showcased by examples from the fields of mechatronic products, healthcare, construction, transportation, astronautics, and the energy sector. We compare our reference architecture model to existing architectures, discuss its advantages and limitations, and position the model within previous literature.

**INDEX TERMS** Applications, cross-industry, digital twins, framework, planning, visualization.

## I. INTRODUCTION

As part of the digitalization trend, the Digital Twin concept is seeing rising interest in academia and industry [1], with Grand View Research expecting a market worth of USD 155.84 Billion in 2030 [2]. The three-part Digital Twin concept was informally introduced by Grieves (see Figure 1), while the enabling technologies only made it technically feasible in the last decade [3]. Digital Twin can be defined as a cross-industry concept containing a physical entity and its digital representation, which evolves with its physical twin in real-time and provides additional value [4]. Digital Twin research can be found in Manufacturing, Aviation,

The associate editor coordinating the review of this manuscript and approving it for publication was Giovanni Merlino<sup>1</sup>.

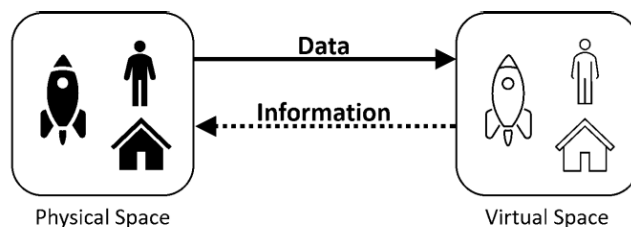

**FIGURE 1.** Illustration from Newrzella *et al.* [4]. The Digital Twin concept based on Grieves [12].

Healthcare, Construction, Oil and Gas Industry, Transportation [5], [6], [7], and many more. In the case of products, Digital Twin research can be found along the entire product

life cycle [8], [9], with use cases such as optimization of process performance and prediction of potential disruptions. In healthcare, human Digital Twin research exists along pathways in domains such as fitness [10] and disease diagnosis and treatment [11], with use cases such as personalized health diagnosis and fitness recommendations.

With this cross-industry dissemination and growth of the Digital Twin concept arise challenges. Confusing terminologies [4], unclear development strategies [13], and a variety of different architectures confuse developers and users and hamper the potential of the Digital Twin concept. This article proposes a cross-industry Digital Twin reference architecture model that aims to consolidate the variety of Digital Twin architectures under three dimensions: Functionality, dependability, and life cycle. Research has shown functional elements' dominant and important role in Digital Twin architectures. Dependability aspects gain more and more importance with Digital Twins becoming further integrated into our lives, becoming more complex, and more reliant on computational intelligence than human decision-making [14]. Therefore, we see designing dependable, reliable, safe, and secure Digital Twins as essential to the concept's success. Finally, a broad life cycle application of the Digital Twin concept is often promoted [8], [9], [15], [16], with such applications tending to drive the most support and value [17].

We see the establishment of a practical reference architecture model that addresses the functional, dependability, and life cycle aspects of Digital Twin applications as a key to the success of the Digital Twin concept across industries. Numerous Digital Twin architectures exist, but none provides a cross-industry reference architecture model with flexible functionality, dependability, and life cycle dimensions. We propose a Digital Twin reference architecture model with these dimensions to address this need. The reference architecture model's independent dimensions enable developers to design and visualize Digital Twin applications of different complexities and industries. This approach allows a structured development and easy comparison of a wide range of Digital Twin applications and their architectures.

In this article, existing Digital Twin and related architectures are analyzed, and their relation to functional, dependability, and life cycle aspects is showcased. From this analysis, we derive our three-dimensional Digital Twin reference architecture model, which is validated on examples from the fields of mechatronic products, healthcare, construction, transportation, astronautics, and the energy sector. Concluding, we discuss our reference architecture model, its relation to other architectures, its limitations, and potential next steps.

## II. RELATED WORK

Since early in Digital Twin research, Digital Twin architectures have been proposed with different focuses, application fields, and levels of detail. This section analyzes Digital Twin architectures proposed in 2021 and earlier and describes their shortcomings. The short descriptions of the architectures

showcase the differences between the architectures, while the overview tables demonstrate commonalities. The overview tables mention the application or purpose of each architecture and place the architectures' functional elements in relation to underlying functionalities (Table 1 and Table 2) and dependability aspects (Table 3). The differences in architectures justify the need for a reference architecture model, while the commonalities demonstrated in the overview tables justify two of the dimensions considered in this article's model.

Grieves first proposed the general idea of a Digital Twin [18] and further described it later in his White Paper [12]. The fundamental structure consists of the physical product, the virtual product, and the connections of data and information that connect both (see Figure 1). He also refers to the connection part as a unified repository. Grieves illustrates his idea of a closely linked physical and virtual factory for quicker and more intuitive design and execution comparison of manufactured products. Grieves describes the core elements of the Digital Twin concept upon which later architectures are built. His work has not defined further functional, dependability, and life cycle aspects.

Tao *et al.* [19] propose a four-component Digital Twin shop-floor architecture comprising a physical shop-floor, a virtual shop-floor, a shop-floor service system, and the shop-floor Digital Twin data tying all dimensions together. The physical shop floor includes humans and machines. The virtual shop-floor dimension consists of geometry-, physics-, behavior-, and rule-based models of its physical counterpart and evolves with its physical counterpart through the data connection between the two. The shop-floor service system contains services for specific demands from the physical and virtual shop floor. These services comprise sub-services in the form of computer-aided tools, Enterprise Information Systems, models and algorithms, etc. The shop-floor Digital Twin data is the center element of the model connecting the other three components and enabling interaction and iterative optimization. The data is integrated, resulting in no distinct data storage entity. While Tao *et al.* mention dependability and life cycle applications, they are not distinctively considered in the architecture.

Josifovska *et al.* [20] analyzed existing Digital Twin literature to identify four main building blocks for their Digital Twin framework, which they propose for application in Cyber-Physical Systems. The framework consists of the physical entity platform, which incorporates the physical entity (objects and humans) and physical nodes (sensors, actuators, user interfaces), the data management platform, which is responsible for data acquisition, management, and storage, the virtual entity platform, which hosts various Digital Twin models (geometric, physical, behavioral, rule, process), and the service platform, which handles the goals of the Digital Twin. Dependability and life cycle aspects cannot be found in the framework.

Lutze [21] focuses on Digital Twins in eHealth and divides his proposed architecture into four general Digital Twin constituents and three different manifestations of Digital Twins.

TABLE 1. Overview of existing Digital Twin architectures within the functionality dimension - part 1.

Author	Application / Purpose	Architecture Diagram
Borangui et al. (2020) [24]	Hybrid supervised control of semi-continuous production process	
IBM (2019) [23]	Across the product lifecycle	
Autiosalo et al. (2019) [22]	High-level guideline on how to design future diverse DT implementations	
Lutze (2019) [21]	Knowl. manag. of AI based, learning eHealth systems via Digital Twin	
Josifovska et al. (2019) [20]	Reference framework for Digital Twins in Cyber-Physical Systems	
Tao et al. (2017) [19]	Digital Twin shop-floor for smart manufacturing	
Grieves (2015) [18]	Manufacturing Replication	

**TABLE 2.** Overview of existing Digital Twin architectures within the functionality dimension - part 2.

Author	Application / Purpose	Author (Year) [Ref]
		Ahleroff et al. (2021) [31]
		Steindl et al. (2020) [30]
		ISO / DIS 23247 -2:2020 [29]
		Abburu et al. (2020) [28]
		Zheng et al. (2020) [27]
		Redelinghuys et al. (2020) [26]
		Räileanu et al. (2020) [25]
		Variety of applications, focus on data and information exchange
		shop floor transp. syst. embedded in glob. manuf. sched. & contr. Syst.

TABLE 3. Overview of existing Digital Twin architectures within the dependability dimension.

Author	Application / Purpose	Author	Author	Author	Author	Author	Author	Author	Author				
	<p>Low dependability</p> <p>High Dependability</p>	Lee et al. (2015) [35]	<p>A Cyber-Physical Systems architecture for Industry 4.0-based manufacturing systems</p> <p>factory level</p> <p>machine level</p>	Lutze (2019) [21]	<p>Knowledge management of artificial intelligence-based, learning eHealth systems via Digital Twin</p> <p>anonymized data</p> <p>pseudonymized data</p> <p>personal data</p>	Răileanu et al. (2020) [25]	<p>shop floor transportation system embedded in the global manufacturing scheduling and control system</p> <p>cloud</p> <p>local</p>	Redelinghuys et al. (2020) [26]	<p>Variety of applications, focus on data and information exchange</p> <p>cloud</p> <p>edge</p> <p>local</p>	Zheng et al. (2020) [27]	<p>Manufacturing</p> <p>cloud</p> <p>edge</p> <p>local</p>	Aheleroff et al. (2021) [31]	<p>Digital Twin as a Service in Industry 4.0</p> <p>cloud</p> <p>local</p>
		<p>Configuration Level <i>Actions to Avoid</i></p> <p>Cognition Level <i>Prioritize and Optimize Decisions</i></p> <p>Cyber Level <i>Self-Compare</i></p> <p>Data-to-Information Conversion Level <i>Self-Aware</i></p> <p>Smart Connection Level <i>Condition Monitoring</i></p> <p>Physical Space</p>	<p>Group Digital Twin</p> <p>System Digital Twin</p> <p>Personal Digital Twin</p>	<p>Analysis and decision making</p> <p>Data update and aggregation</p> <p>Data transmission</p> <p>Data collection and edge processing</p> <p>Physical space</p>	<p>Cloud-based Info. Reposit.</p> <p>IoT Gateway</p> <p>Local Data Repositories</p> <p>Physical Twin Local controllers and data acquisition</p> <p>Physical Twin Sensors</p>	<p>Interaction Layer</p> <p>Cyberspace Layer</p> <p>Data extraction and consolidation Layer</p> <p>Physical Layer</p>	<p>Application Layer</p> <p>Cyber Layer</p> <p>Digital Layer</p> <p>Physical Layer</p> <p>Communication Layer</p>						

The constituents are a unique identifier of the twin, a causal network that maps symptoms to conclusions, a structured description containing inherent characteristics and states of the physical entity, and a utilization context for linking twin manifestations. Lutze's three manifestations of Digital Twins are called Personal Digital Twin, System Digital Twin, and Group Digital Twin. Personal Digital Twins represent individual persons with their personal, behavioral, and clinic data, symptoms, and conclusions. Numerous Personal Digital Twins are used to train an artificial intelligence software system called System Digital Twin, which provides diagnostic recommendations for a group of individuals with similar characteristics and states. Such a group of similar Personal Digital Twins is represented by depersonalized Group Digital Twins, which serve as characteristics check for new Personal Digital Twins and which System Digital Twins they can be applied to for diagnostic recommendations. Lutze's architecture aims to enable eHealth Digital Twins compliance with the EU General Data Protection Regulation. This proposal includes functional elements and data privacy-based dependability levels. However, life cycle aspects are not considered.

Autiosalo *et al.* [22] analyze existing Digital Twin publications and derive ten distinguishable features in a Digital Twin that they propose allocating in a star structure around the data link feature. The features are the data link, coupling, identifier, security, data storage, user interface, simulation, analysis, artificial intelligence, and computation. The data link is the center element of the architecture, connects digital things to each other, and acts as the hub for all physical twin information. The coupling feature is a two-way interface connecting the physical entity to its Digital Twin. At the same time, the identifier uniquely identifies a Digital Twin in the physical and digital world. Security must be embedded in the entire Digital Twin architecture to fulfill the specific use case's needs. Data storage can be located locally and globally and stores all the Digital Twin's data, and the user interface lets users interact with the Digital Twin. Simulation provides the Digital Twin with dynamic, steady, visual, graphical, or numerical approximations of its physical twin's behavior. An analysis uses these simulations and the physical twin data to generate recommendations for the Digital Twin for decision making. A Digital Twin with an artificial intelligence feature is able to make autonomous decisions. Computation is required across the entire Digital Twin and is an essential feature. The framework of Autiosalo *et al.* mentions ten interconnected functional elements of a Digital Twin but does not provide dependability and life cycle aspects for developing Digital Twin applications.

In 2019, IBM proposed a Digital Twin reference architecture for products across the entire product life cycle [23]. It consists of seven layers of information management and manipulation and three columns that ensure secure, suitably governed and coupled Digital Twin operation. The seven layers consist of IoT (Internet of Things) Stack, Data, Systems of Record, Simulation Modelling, Analytics and Artificial

Intelligence (AI), Visualization, and Process management. The authors mention that Digital Twins integrate into existing enterprise applications which can be allocated to the seven functional layers. Dependability and life cycle aspects are not considered in IBM's reference architecture.

Borangiu *et al.* [24] applied the new four-layer ARTI reference architecture to the production process of radio-pharmaceuticals to enable collective and predictive situation awareness and bring software control and real process closer together. The data acquisition and transmission layer acquires and pre-processes process data. The process models layer represents and emulates individual processes, which the data analysis layer uses together with device data to predict equipment status, product characteristics, and process parameters and detect anomalies. The decision-making layer applies these insights to operate the supervised production control. While functional elements are represented, the architecture does not include dependability and life cycle aspects.

Răileanu *et al.* [25] apply their four-layer Digital Twin control architecture to a shop floor transportation system embedded in the global manufacturing scheduling and control system. The data collection and edge processing layer creates information from the data of the physical entity, forwards it to the data transmission layer, and executes orders received from the upper layers. The data transmission layer communicates with the two upper layers in the cloud. The data update and aggregation layer contains, for example, database storage, CAD models, and transportation graphs. At the same time, the analysis and decision-making layer makes decisions based on AI techniques to send the decisions back down through the layers for execution. Răileanu *et al.*'s architecture links functional and dependability aspects by placing the data update and aggregation and the analysis and decision-making layer in the cloud. Therefore, the architecture only applies to the mentioned application and restricts local Digital Twin applications from being represented. Furthermore, a life cycle aspect is not considered.

Redelinghuys *et al.* [26] propose a six-layer digital twin architecture for various applications, highlighting the exchange of data and information between the physical twin and remote simulation or emulation. The architecture consists of sensor and local controller/data acquisition layers, a local data repositories layer, an IoT Gateway layer, a cloud-based information repositories layer, and an emulation and simulation layer. Users interface with the Digital Twin through the emulation and simulation layer, whereas the IoT Gateway layer also provides a GUI. The architectural elements can be divided into three dependability levels, local, edge, and cloud. This allocation shows the fusion of functional and dependability aspects, highlighted by data storage located on both the local and cloud levels. Digital Twin implementations across life cycles are difficult to visualize.

Zheng *et al.* [27] propose a generic system architecture for Digital Twin establishment consisting of four layers, the physical layer, the data extraction and consolidation layer, the cyberspace layer, and the interaction layer. The physical layer

contains the physical system, its environment, and its data outputs and sensors. The data extraction and consolidation layer processes the data from the physical layer and passes it on to the cyber layer. The cyberspace layer establishes the Digital Twin by containing models of the physical entity and provides universal access to the physical entity by being located in the cloud. The interaction layer allows users to interact with the physical entity through the Digital Twin in the cloud. Zheng *et al.*'s architecture combines functional and dependability aspects while not considering life cycle aspects. Digital Twin applications cannot be represented at different dependability levels and across life cycle stages.

Abburu *et al.* [28] propose three different capability versions of Digital Twins: Digital Twin, Hybrid Digital Twin, and Cognitive Digital Twin. These three layers are based on isolated models, then interconnect the models and extend them with expert and problem-solving knowledge. The autonomous Cognitive Digital Twin consists of five main layers, adapters, and a broker for data acquisition from the physical entities. The data ingestion and preparation layer pre-processes and stores data for further usage. The model management layer ensures efficient storage and access to models called by different services from the service management layer. The service management layer resolves domain problems by orchestrating services. The user interaction layer supports a user in exploring the Cognitive Digital Twin and its characteristics. The twin management layer ensures the interconnection of the physical entity and its digital representation. Abburu *et al.*'s architecture provides functional elements but does not include dependability and life cycle aspects.

The International Organization for Standardization (ISO) issued an international standard draft in 2020 to propose a Digital Twin framework for manufacturing to support the creation of Digital Twins in manufacturing [29]. Part 2 explains the reference architecture consisting of four entities, the data collection and device control entity, the core entity, the user entity, and the cross-system entity. The observable manufacturing elements are outside the Digital Twin framework but are mentioned to facilitate understanding of the framework. The data collection and device control entity monitors and collects data from the physical devices and controls and actuates these. The core entity handles the overall operation and management of the manufacturing Digital Twin, hosts applications and services such as analysis and simulation, and guarantees interoperability with other entities. The user entity provides interfaces for any entity that utilizes the Digital Twin for manufacturing, such as humans, devices, enterprise resource planning (ERP) systems/manufacturing execution system (MES), and other core entities. The cross-system entity is allocated across entities and provides common functionalities such as data assurance, data translation, and security support. The ISO/DIS 23247-2 elaborates various functional elements but planning the dependability and life cycle aspects of Digital Twin applications is difficult.

Steindl *et al.* [30] criticize the often application-specific Digital Twin solutions without general architectural concepts and propose a generic Digital Twin architecture that can be applied technology-independent. From an overview of concepts, architectures, and frameworks for Digital Twins, they derive a generic 6-layer architecture. The asset layer contains the physical entity, whereas the integration layer makes run-time and engineering data available. The communication layer ensures the correct data transfer protocols to the information layer, which pre-processes and stores the data. The functional layer provides simulation, monitoring, diagnostics, prediction, control, and reconfiguration services. Those services are equipped with an appropriate human-machine interface to engage with humans. The business layer hosts the business logic that defines the Digital Twin's overall objectives. Steindl *et al.*'s architecture describes functional elements and targets the "instance-phase" in the life cycle dimension of the RAMI4.0. Therefore, an application across all life cycle stages is difficult, and dependability aspects cannot be explicitly planned.

Aheleroff *et al.* [31] divide their Digital Twin reference architecture model into three dimensions, Digital Twin layers, value life cycle steps, and level of integration. This division aims to facilitate the understanding of complex interrelations by breaking them into smaller and simpler clusters. The dimension of the Digital Twin layers consists of the physical layer, the communication layer, the digital layer, the cyber layer, and the application layer. The physical layer contains the physical assets, sensors, and actuators. The communication layer handles inter-layer communication, and the digital layer incorporates static data locally, such as CAD files. The cyber layer includes cloud processing, storage, simulation, and modeling. The application layer makes the outcomes available through user interfaces. The dimension of the value life cycle mentions the iterative, incremental value life cycle. The dimension of the level of integration contains the three types of data flow of Kritzinger *et al.* [32] and the Digital Twin predictive as a cloud-enabled Digital Twin using Big Data and Machine Learning. Aheleroff *et al.*'s architecture merges functional and dependability aspects in their Digital Twin layers and involves dependability aspects in their level of integration. This merging restricts the model from being applied to Digital Twin applications with different dependability characteristics on these layers and levels.

Cyber-Physical Systems (CPS) are physical systems connected to communication and computation entities over the internet [33], [34]. Digital Twins enable CPSs to self-configure, self-adjust, and self-optimize [20], and both concepts are often mentioned together. Lee *et al.*'s [35] 5-layer architecture for CPS in Industry 4.0-based manufacturing systems is often referred to in Digital Twin architectures [25], [26], [27], [30], [36]. The architecture often referred to as 5C architecture consists of five "C" levels, the smart connection level, the data-to-information conversion level, the cyber level, the cognition level, and the configuration level. Each level enables different functions based on its complexity

and connectivity. The smart connection level acquires accurate and reliable data from the physical entity. The data-to-information conversion level brings self-awareness to the machines by calculating condition values, remaining lifetime, etc. The cyber level connects all machines to a central information hub to compare performances and predict future behavior. The cognition level visualizes individual and comparative information to prioritize the optimization tasks. The resulting corrective and preventive decisions are returned from cyber space to physical space at the configuration level. The 5C architecture is built around types of use cases enabled by functional elements and connectivity capabilities on each level. The architecture merges use-cases with functional and dependability aspects by assigning the connection and conversion level to the machine and the cyber, cognition, and configuration level to the factory layer. Alternative allocations of functional elements on different levels can therefore not be represented. Furthermore, the architecture does not consider cross-life cycle applications.

The term “Industry 4.0” stands for the fourth industrial revolution, where humans, objects, and systems are interconnected to achieve real-time analysis and optimization. The Digital Twin is seen as a key concept for Industry 4.0 [37], [38], and Digital Twin applications are often found in manufacturing as part of Industry 4.0 [19], [26], [30], [31], [38]. In 2015 the joint project “Plattform Industrie 4.0” consisting of associations and companies developed the Reference Architecture Model Industry 4.0 (RAMI4.0) [39]. The model aims to satisfy the need for a unified reference architecture model to discuss interdependencies and details of Industry 4.0 matters, particularly standards and norms. This reference architecture model is often referred to in Digital Twin architectures [30], [31] and is also considered in this article’s Digital Twin reference architecture model. RAMI4.0 consists of three dimensions: Layers for representing different information views, life cycle & value stream for dividing matters into different life cycle stages, and hierarchy levels for assigning functional models to specific levels. View layers range from asset, integration, and communication to information, functional, and business. Life cycle & value stream stages are divided into type (general product development information) and instance (unique manufactured product) and show development/production and maintenance/usage stages. The hierarchy levels range from product, field device, control device, and station to work centers, enterprise, and connected world. RAMI4.0 provides functional elements, hierarchy levels which can be seen as a type of dependability classification, and life cycle aspects. We see these dimensions as equally important for Digital Twins and utilize them to visualize networks of Digital Twin elements and their interplay across these dimensions. While RAMI4.0 uses these dimensions to classify Industry 4.0 norms and standards, the proposed reference architecture model uses these dimensions to visualize entire Digital Twin architectures.

The analyzed Digital Twin architectures focus on functional elements, sometimes combined with dependability aspects. Life cycle applications are mostly only mentioned without the aspect being explicitly integrated into an architecture for the life cycle planning of an application. This lack of flexibility prevents the application of different kinds of Digital Twin use cases across industries, as they can be applied across the entire life cycle of its entity and at different levels of dependability. We present a Digital Twin reference architecture model that addresses this research gap. The model independently considers functionality, dependability, and life cycle aspects in its design, enabling a broad range of applications to be designed and visualized.

### III. REFERENCE ARCHITECTURE MODEL

We see the need to develop a uniform architecture model as a reference based on which interrelationships and details of Digital Twin applications can be discussed. We propose the Innovation Think Tank Digital Twin Reference Architecture Model, which contains the essential aspects of a Digital Twin. Figure 2 shows a schematic overview of our Digital Twin reference architecture model. A three-dimensional model can best represent the Digital Twin space. The model is inspired by RAMI4.0. It was adapted based on the Digital Twin requirements. The vertical axis describes possible functional elements that can be used to implement a Digital Twin application. The depth axis divides the Digital Twin components into application-specific dependability levels for better safety, security, and privacy planning. The horizontal axis represents the life cycle aspect of a Digital Twin, where Digital Twin components and their interrelationships can be mapped along the life cycle of the physical entity. Thus, the special characteristics of the reference architecture model are the combination of functionality, dependability, and life cycle aspects. These aspects provide a high degree of flexibility for describing Digital Twin applications. The approach also allows the encapsulation of dependability cages, as proposed by Aniculaesei *et al.* for autonomous systems [40]. Compared to most other Digital Twin architectures, this article’s reference architecture model provides a sufficient level of abstraction rather than a concrete architecture to enable the development and description of Digital Twin applications of different complexity and from different industries. The reference architecture model defines a basic structure and the main dimensions and components for Digital Twin applications without confining it to specific technologies. Thus, the prerequisites are created to describe and realize highly flexible Digital Twin architectures through the reference architecture model proposed in this article.

The model allows the step-by-step development from simple to complex Digital Twins and the definition of applications with distinct specifications and requirements. For realizing a Digital Twin application based on this reference architecture model, functional elements with different complexities can be allocated at different dependability levels at



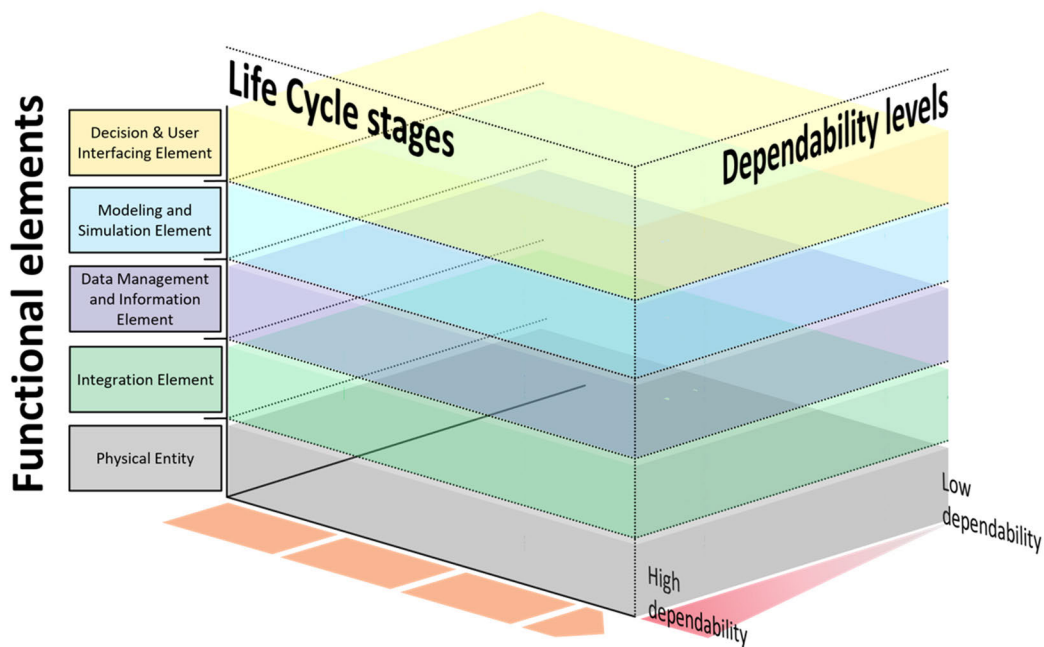

FIGURE 2. Schematic of the Innovation Think Tank Digital Twin reference architecture model.

different life cycle stages. The interrelationships and communication between the functional elements further define the Digital Twin applications in the proposed model. This approach means that specific technologies are defined by the functional elements, depending on the application. These elements can be allocated at different dependability levels, only adapting their communication and security setups to account for different dependability requirements, for example. The allocation of the functional elements at different life cycle stages does not require additional technologies either. The functional elements and their technologies might, for example, communicate with different functional elements depending on their life cycle stage. The three dimensions are described in more detail further below, while specific application examples are given in the validation case study section.

#### A. FUNCTIONAL DIMENSION

The vertical axis in Figure 2 displays the functional dimension, which consists of functional elements. These elements provide logical groupings of functionalities and tasks which a Digital Twin application can use. This element-based design helps break down complex applications into building blocks of specific functionality. This division bears advantages such as reuse of solutions, reconfigurability, modular analysis and validation, and controllability [41]. Elements can be omitted, used multiple times in different orders, and interact with each other in various ways. The displayed order of the functional elements in the proposed reference architecture seems common across numerous analyzed architectures (Table 1 and Table 2). Still, the number of used elements, their capabilities,

and interactions are application-specific. The analysis further identified six ubiquitous functional elements with distinct sets of tasks, inspired by Schoueri [42]. The physical entity is the basis for any Digital Twin application and builds the functional dimension's basis. The integration element consists of data sources that record and transfer data from and around the physical entity. Low-level pre-processing can also be executed within the integration element. The data management and information element further pre-processes the data, creates information out of it by putting the different data sources in context, and stores the data in a format convenient for further analyses. The modeling and simulation element combines data to digitally represent the physical entity in time and space and simulate potential future scenarios. The decision and user interfacing element orchestrates goals and priorities of the Digital Twin with the user having access in, for example, either read or write mode. The communication element is not considered a distinct element in the reference architecture model as its functionality is spread across the other elements. Communication between the elements and outside entities can be visualized through different kinds of arrows and their annotations between the involved parties.

#### B. DEPENDABILITY DIMENSION

The depth axis in Figure 2 represents the dependability dimension. “Dependability” can be defined as “The quality of being trustworthy and reliable.” [43]. In autonomy, “dependability” is often used when referring to safety, security, and privacy issues as a whole [40]. The same definition is used in this article. Dependability aspects can be quite versatile and depend on the application. For example,

in autonomous systems, a Digital Twin in a safety-critical application requires very low latency to provide the safety level required. A human Digital Twin handling personal data requires different levels of data privacy depending on the anonymization of the data. A Digital Twin with access to critical information and actions requires different security levels depending on the application. The analysis of CPS and Digital Twin architectures identified different levels of dependability. In manufacturing, common dependability levels are local, edge, cloud, and cloud interaction or machine and factory level. Human Digital Twin dependability levels can be categorized into personal, pseudonymized, and anonymized data. We separate the dependability dimension from the functional dimension. This separation allows the development and visualization of Digital Twin applications with different functionalities at different dependability levels. The exact dependability levels are left open to allow the use of the reference architecture model across industries and applications. The examples are supposed to give the reader an understanding of possible dependability levels.

### C. LIFE CYCLE DIMENSION

The horizontal axis in Figure 2 depicts the life cycle dimension. The term “life cycle” used in this article refers to “the series of changes that a product, process, activity, etc. goes through during its existence” [44]. Digital Twin functional building blocks, connections, and dependability levels depend on the life cycle stage where the physical twin(s) of a Digital Twin reside(s). The types of life cycle stages depend on the application. Digital Twins of products can be mapped along their product life cycle. Human Digital Twins can be considered along a disease pathway or across an athlete’s routine activity zones. In logistics, a Digital Twin can be used along the logistics supply chain. Life cycle stages do not have to represent chronological time frames but can also represent reoccurring time frames, such as in the example of an athlete’s activity zones. The reference architecture model’s concrete life cycle stages are left open to allow application-specific time frames across industries. The mentioned examples intend to give the reader an idea of possible applications.

We proposed a three-dimensional Digital Twin reference architecture model based on functionality, dependability, and life cycle aspects. This separation provides great flexibility for applications of different complexities and industries. To demonstrate the model’s versatile applicability, validation examples are shown from six different industries.

## IV. VALIDATION CASE STUDY

The applicability of the reference architecture model is demonstrated in six examples. The examples represent Digital Twins from the fields of mechatronic products, healthcare, construction, transportation, astronautics, and the energy sector. The examples only present a selection of functional elements to facilitate the understanding of potential applications.

### A. MECHATRONIC PRODUCT

The first example in Figure 3 features a Digital Twin setup in the field of medical mechatronic products along the product lifecycle, which was developed and tested at the Siemens Healthineers Innovation Think Tank. The Digital Twin is visualized along the three product life cycle stages “Development & Manufacturing,” “Operation,” and “Maintenance.” The dependability dimension considers privacy and safety aspects and is subdivided into “Device level,” “Room/Factory level,” and “Cloud level.” Functional elements are allocated across these dimensions and represent two interconnected Digital Twin applications described separately below. The application elements in the “Operation” stage have been developed and tested at the Siemens Healthineers Innovation Think Tank. The other life cycle stages elements have been added for demonstration purposes. The first application represents the work of Mahmeen *et al.* [45] and can be described according to the Digital Twin applications model of Newrzella *et al.* [4] as follows. Mahmeen *et al.* describe a Digital Twin of a Radiography device’s environment using real-time device encoder data and point cloud data from room depth cameras in a rule-based model for enabling autonomous collision avoiding movement of the device. The functional elements involved in this application in Figure 3 reside in the “Operation” stage and constitute the Radiography device as the physical entity on the device level, encoders as an integration element on the device level as well as room cameras as an integration element on the room level of the hospital. On the room level also lie a local data storage as data management and information element and a room computing unit as modelling and simulation element. The encoders send the device’s position to the room data storage, where also the point cloud data of the radiography room is received. This data storage directly interacts with the Robot Operating System (ROS) on the room computing unit, where point clouds are merged, obstacles are detected and recognized, and the motion planning subsystem calculates the planned path and outputs control commands to the radiography device’s motors. This setup enables the device to detect and identify objects in the room and adapt its movement accordingly without human intervention.

The second application is a Digital Twin predictive maintenance application along the three mentioned product life cycle stages. It can be described as a Digital Twin of a Radiography device’s condition using endurance test data, technician maintenance data, and operational encoder data in a data-based model for enabling usage-based maintenance. In the “Development & Manufacturing” stage, data is gathered during the endurance test (integration element) of a ceiling-mounted radiography device in testing (physical entity). This data is stored in the factory data storage (data management and information element) before being uploaded to a cross-life cycle stages cloud storage (data management and information element). In the “Maintenance” stage, a technician analyzes

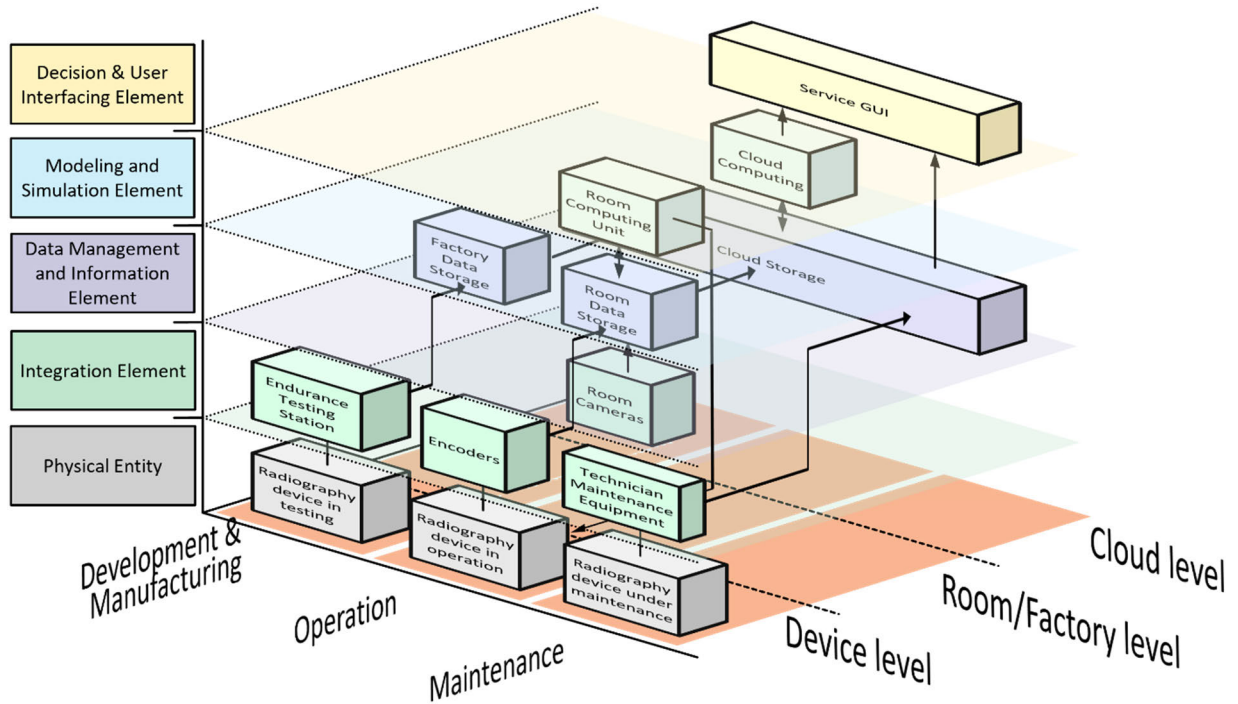

**FIGURE 3.** Architecture validation example of a medical mechatronic Digital Twin along a product life cycle at the Siemens Healthineers Innovation Think Tank.

(integration element) the Radiography device in operation (physical entity) and uploads the diagnosis to the cross-life cycle cloud storage (data management and information element). The technician can also access the service Graphic User Interface (GUI) on the cloud level (decision & user interfacing element) to get insights from the device’s historical data before going to the device. In the “Operation” stage, the encoders (integration element) of the radiography device in operation (physical entity) send their data to the room data storage on the room level (data management and information element). The data is sent to the cloud level’s cross-life cycle stage cloud storage (data management and information element). The data is summarized in a histogram model on the cloud computing unit (modeling and simulation element) and visualized through Power BI for the health assessment by a technician on the service GUI (decision & user interfacing element).

The 3D architecture model can be reduced to certain 2D section views to showcase certain aspects in more detail (see Figure 4). This reduction can be compared to 2D section views in a CAD file. An example is given on the predictive maintenance application with a section view of the “Operation” life cycle stage (see Figure 5). The 2D section view shows the Digital Twin setup in more detail, as also described by Schoueri [42].

**B. HEALTHCARE**

The second example in Figure 6 illustrates a human precision medicine Digital Twin concept across a disease

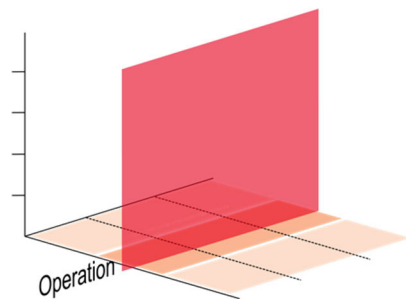

**FIGURE 4.** Schematic illustrating the reduction of a 3D architecture model to a 2D section view.

pathway (Figure 6). The life cycle stages are subdivided into the “Prevention & Symptoms,” “Diagnosis & Therapy,” and “Rehabilitation & Follow-up” stages, as suggested by the Innovation Think Tank disease pathway framework by Haider et al. [46]. The dependability levels consist of “Personal data,” “Pseudonymized data,” and “Anonymized data.” The functional elements and their connections are allocated across life cycle and dependability stages and represent an example from precision medicine. The dependability levels consist of “Personal data,” “Pseudonymized data,” and “Anonymized data.” The functional elements and their connections are allocated across life cycle and dependability stages and represent an example from precision medicine. In the “Prevention & Symptoms” stage, individuals collect data through personal smart devices such as smartphones

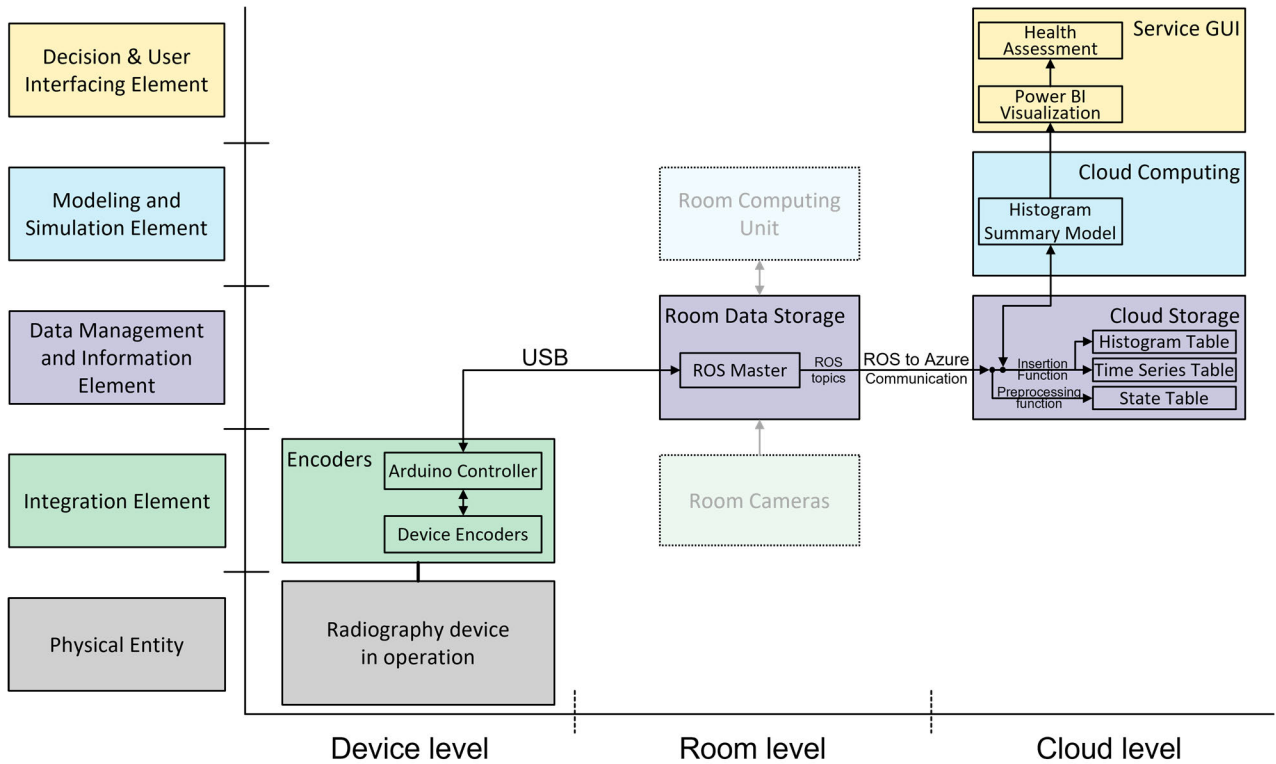

FIGURE 5. 2D section view of the Digital Twin predictive maintenance application example in the “Operation” life cycle stage.

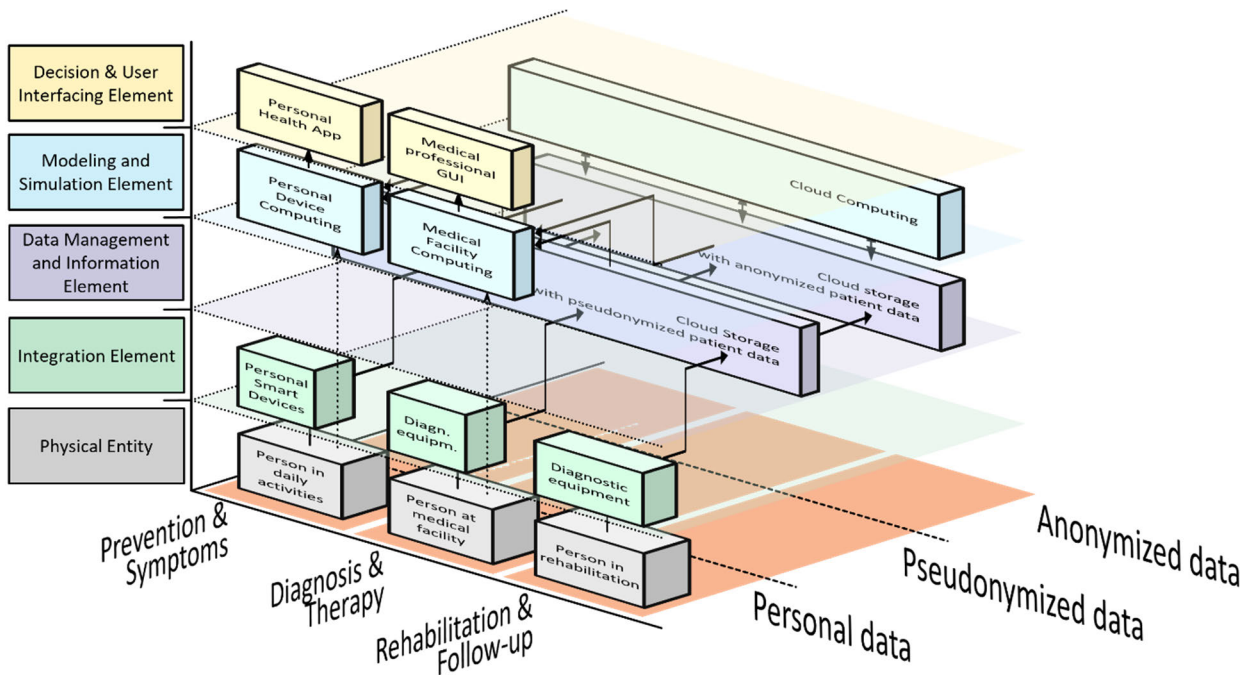
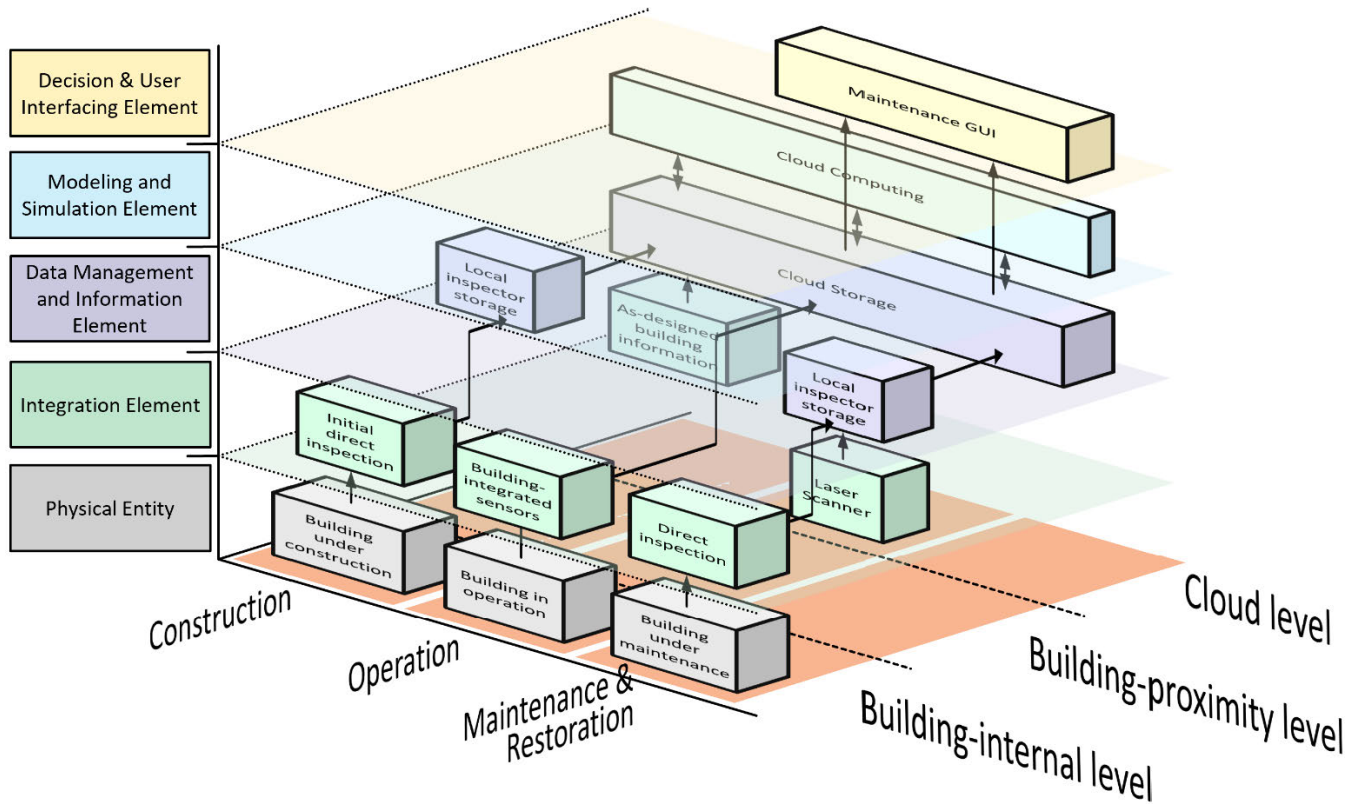

FIGURE 6. Architecture validation example of a human precision medicine Digital Twin along a disease pathway.

and smartwatches (integration element). The data collected can be, for example, lifestyle, environmental, and health data. This data is de-identified and marked with an artificial

identifier before being transmitted to cloud storage, where many individuals’ pseudonymized data is stored (data management and information element).



**FIGURE 7.** Architecture validation example of a building Digital Twin along a building's life cycle.

In the “Diagnosis & Therapy” stage, the individual is diagnosed and/or treated. Data is generated in the form of imaging, laboratory, genomics, and other diagnostic data (integration element) and shared with the pseudonymized cloud storage (data management and information element). During the “Rehabilitation & Follow-up” stage, data about the efficacy of treatments and rehabilitation measures are gathered (integration element) and associated with the individual's pseudonymized data in the cloud storage (data management and information element). The collections of all individuals' data sets on the pseudonymized cloud storage are copied, fully de-identified, and sent to the anonymized cloud storage (data management and information element). Data-based algorithms for detecting various diseases are trained on the cloud computing element (modeling and simulation element), considering all the available data. The resulting disease diagnosing and broadly trained algorithms are stored in the anonymized cloud storage and can be requested from the personal device and medical facility computing (modeling and simulation element) in the “Prevention & Symptoms” and “Diagnosis & Therapy” stages, respectively. The algorithms can be fed with the individual's data by personalizing the data again through the individual's personal key. Combining broadly trained algorithms with personal data enables consistent and reproducible diagnostic results, which can be displayed to the individual and the medical professionals through the personal health app and the medical professional

GUI, respectively (decision & user interfacing element). This setup provides a holistic and precise understanding of an individual's condition, which enables personalized diagnosis and treatment tailored to both the individual and the disease, avoiding unnecessary or ineffective therapies. A patient can go to a medical professional, get checked, and get a diagnosis based on a worldwide repository of health conditions and treatments.

### C. CONSTRUCTION

Figure 7 visualizes the example of a building Digital Twin, inspired by Angjeliu *et al.* [47]. The life cycle stages consist of “Construction,” “Operation,” and “Maintenance & Restoration.” The dependability levels are subdivided into the building-internal, building-proximity, and cloud level. In the “Construction” stage, as-designed building information such as geometry, material properties, and construction techniques are created and stored in the building's cloud storage. Construction inspectors review the quality of the finished building and document their findings in their local storage before uploading their report to the building's cloud storage. In the “Operation” stage, inbuilt sensors such as accelerometers, pressure, and stress sensors provide real-time data of the building's structural integrity and send it to the building's cloud storage. In the “Maintenance & Restoration” stage, inspectors check the building's structural integrity directly on the building-internal and building-proximity levels through

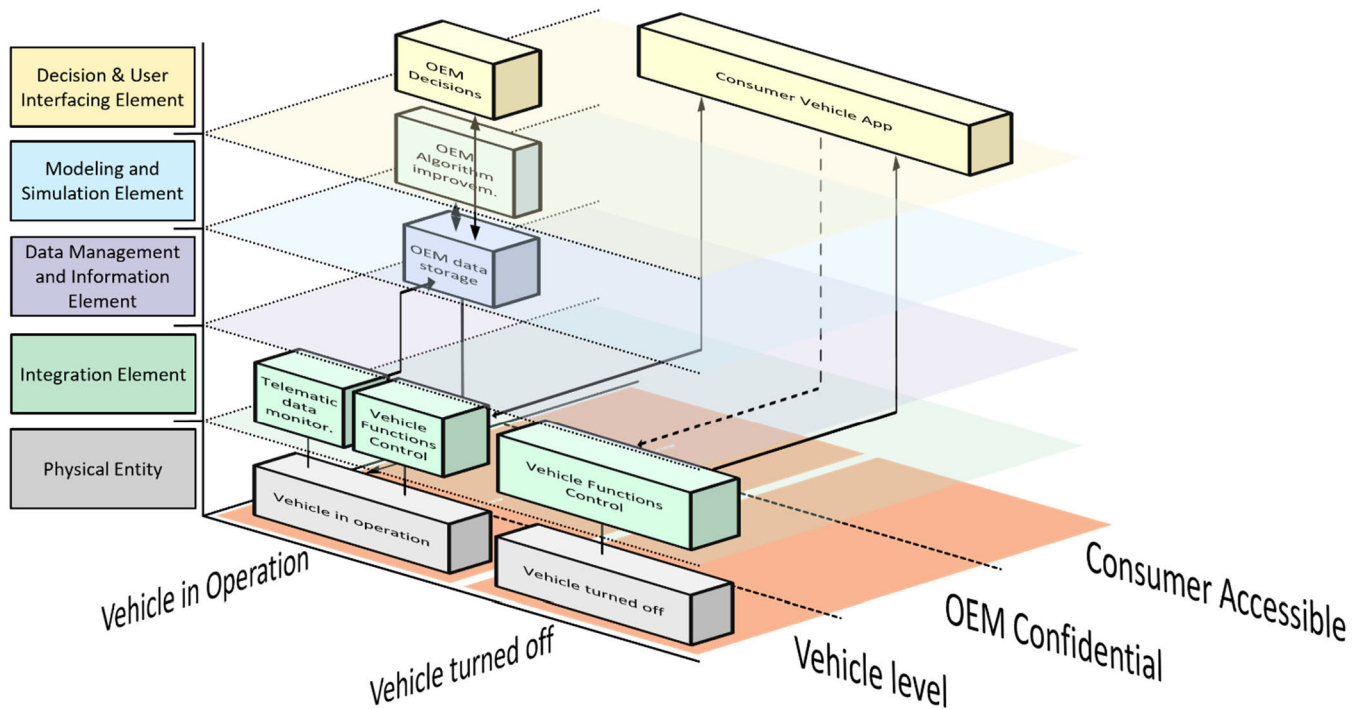

FIGURE 8. Architecture validation example of a vehicle Digital Twin along different vehicle life cycle states.

laser scanners and image-based methods. The final report is uploaded to the building's cloud storage. On the cloud level, historical and real-time data from all three life cycle stages are processed in various mathematical models in the cloud computing element to assess the building's structural integrity, predict potential failures, and schedule predictive maintenance and restoration. The building operators can access these reports via the building's maintenance GUI on the cloud level. This setup allows the building operators to get notified of potentially critical building degradations and proactively address them before they cause any harm.

#### D. TRANSPORTATION

An example from the transportation industry is visualized in Figure 8. It shows the Digital Twin functionalities of a vehicle as an example for a consumer product, as inspired by the analysis of Ried [48]. The life cycle dimension consists of the states "Vehicle in operation" and "Vehicle turned off." The dependability levels are vehicle level, OEM confidential, and consumer accessible. While the vehicle is in operation, it monitors telematic data and controls the vehicle's functions. The telematic data is streamed confidentially to the OEM's data storage. The OEM's modeling and simulation element can model and predict vehicle performance and improve functionalities such as autonomous driving from simulations and data models from other vehicles. Once approved by the OEM's decision entity, these outcomes are sent back to the vehicle in the form of maintenance alerts and software updates. A remote control can be granted to the user through

the consumer vehicle app, which connects to the vehicle functions control. The user can inquire about vehicle information such as location and energy level and enable or disable vehicle settings such as heating. When the vehicle is turned off, the OEM does not have access to the telematic data, and the user must activate the vehicle when requesting access to the vehicle's functions control. Once remotely activated, the user can access the vehicle functions control again. This setup allows the OEM to optimize the driver's driving experience based on individual and global vehicle data. The vehicle user stays informed about and can control the vehicle remotely.

#### E. ASTRONAUTICS

Figure 9 showcases an example of a spacecraft Digital Twin along different space flight phases, as inspired by Yang *et al.* [49]. The life cycle dimension is made up of three space flight phases, "Spacecraft on Earth," "Spacecraft in Earth orbit," and "Spacecraft in outer space." In this example, the dependability dimension represents the safety aspect by allocating different functionalities along the dependability levels real-time, low latency, and high latency. While the spacecraft is still on Earth, its position sensors and flight controls are calibrated, and their settings are communicated to the Mission Control Center (MCC) data storage. These settings are considered in the mission planning being executed on the MCC computing unit. Once the MCC flight controller team approves, the mission plan is transmitted to the spacecraft. After launch, while in high latency communication range to satellites in Earth orbit, the spacecraft sends its sensed

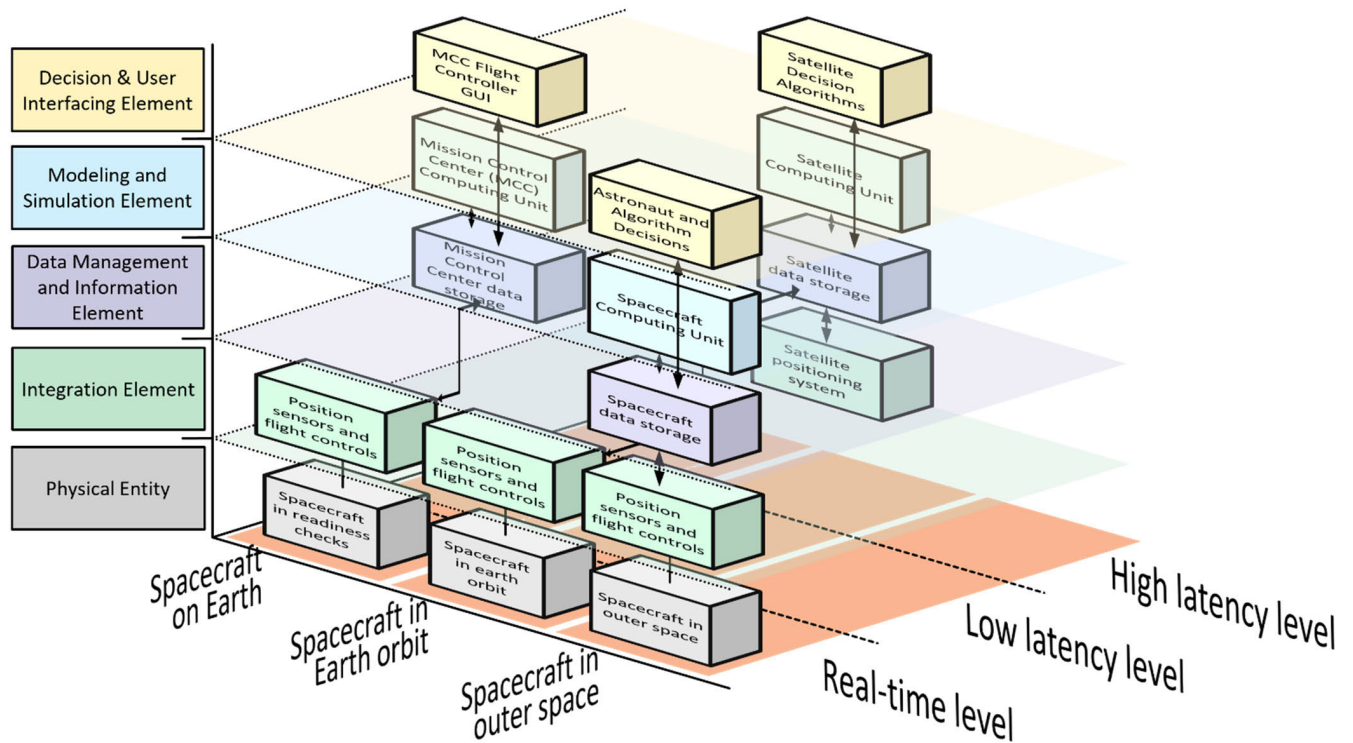

FIGURE 9. Architecture validation example of a spacecraft Digital Twin along different space flight phases.

position to nearby satellites. These satellites independently determine the spacecraft's position (integration element) and adjust the mission plan when necessary (satellite computing unit and decision element). The updated mission plan is then communicated back to the spacecraft. When in outer space, the spacecraft acts autonomously with its own set of data storage, computing unit, and astronaut and algorithm decision element. Mission plan adjustments are calculated with the sensory and computational resources available. This setup allows the spacecraft always to consider the most reliable and available location information and plan further mission plans accordingly. It aims to reduce late correction maneuvers and increase the probability of a safe and efficient mission.

## F. ENERGY SECTOR

An example of critical national infrastructure, the energy sector, a cluster of windmills during different cyber-attack incidence stages, is visualized in Figure 10. The life cycle dimension portrays different cyber-attack scenarios according to the Cybersecurity & Infrastructure Security Agency (CISA) National Cyber Incident Scoring System (NCISS) [50]. The dependability dimension represents security aspects and is divided into IEC 62443 security levels (SL) [51], where the levels include protection against intentional violation using simple means (SL2), sophisticated means (SL3), and protection against intentional attacks with sophisticated means (SL4). The Digital Twin architecture is designed to guarantee functionalities depending on the severity of an incidence. In case of a major incident with

a likely to an imminent threat to the provision of national infrastructure services, individual windmills must comply with SL4 standards. They are designed to locally sense and store their state (integration, data management, and information element), model the effects of their behavior, and make and act on decisions based on that (decision element).

In addition to this functionality, in case of a less severe attack with unlikely or potential impact on national infrastructure services, windmill clusters must be designed to follow SL3 standards by guaranteeing inter-windmill data collection (data management and information element), analysis of network power generation and distribution (modeling and simulation element) and acting based on the decisions made from this analysis (decision element). In the case of a baseline (level 0) event, SL2 standards must be met to guarantee the collection of windmill data in the cloud (data management and information element), its analysis for predictive analytics (modeling and simulation element), and visualization on the power grid surveillance dashboard (user interfacing element). This setup protects critical functionalities depending on the level of a cyber-attack incidence, promising continuous and safe operation of the windmill. This structure helps the windmill operations staff better react to different cyber-attack severities.

In the related work section, the shortcomings of existing architectures were described. In this section, the applicability of the reference architecture model was validated on examples from six different fields of application. The usage of the model was showcased, and how different Digital Twin

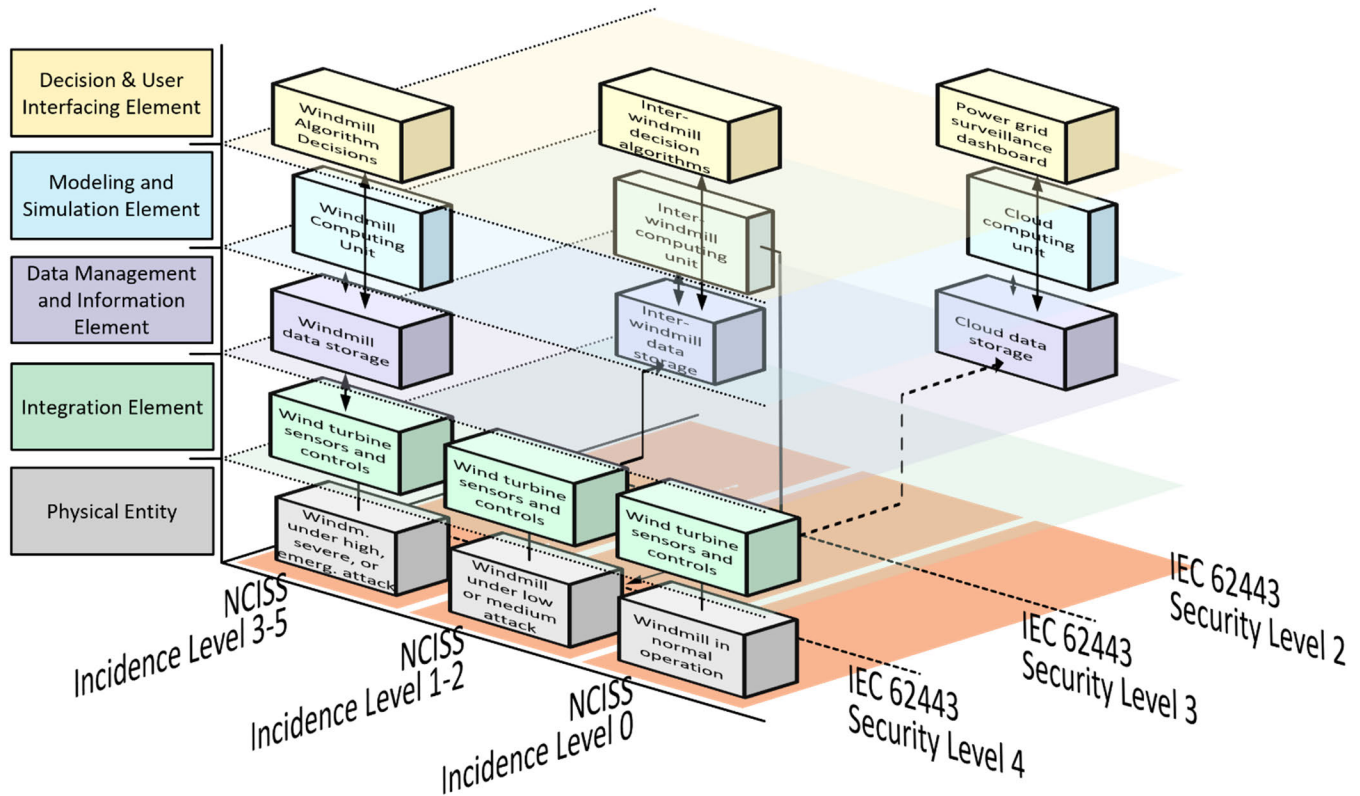

**FIGURE 10.** Architecture validation example of a national infrastructure Digital Twin during different cyber-attack incidences.

applications can be visualized with it. In the next section, the compatibility of the reference architecture model with the existing architectures is demonstrated, and the model's limitations are discussed.

## V. DISCUSSION

This article aimed to propose a Digital Twin reference architecture model for application across industries, focusing on functionality, dependability, and life cycle aspects. While the Digital Twin concept is often described as being applicable to any field and across the entity's life cycle, with varying degrees of complexity and dependability, none of the researched architectures address these aspects in one single approach. Aheleroff *et al.* [31] propose a three-dimensional reference architecture model that combines functionality and dependability in one dimension. This combination reduces the flexibility of applications being representable by the architecture model. We separate these aspects in our reference architecture model and show its versatile applicability in validation examples from the fields of mechatronic products, healthcare, construction, transportation, astronautics, and the energy sector. Through the simultaneous consideration of functionality, dependability, and life cycle aspects, existing architectures can be described by our reference architecture model within these dimensions.

Following, all three dimensions are described, how they relate to existing architectures, and what limitations they face.

Within the functionality dimension, the physical entity is mentioned by other architectures as physical product [12], physical shop-floor [19], physical entity platform [20], real world [23], physical twin [24], physical space [25], physical layer [27], [31], observable manufacturing elements [29], and asset layer [30]. Some do not consider the physical entity part of the architecture [29]. Still, we see it as an essential part of the Digital Twin concept where the type and whereabouts of the physical entity greatly impact the rest of the Digital Twin architecture. Therefore, we specifically include the physical entity in the reference architecture model.

The integration element is referred to by other architectures as input data [21], coupling [22], IoT stack [23], data collection and edge processing [25], physical twin sensors and physical twin local controllers and data acquisition [26], data extraction and consolidation layer [27], adapters [28], data collection and device control entity [29], and integration layer [30]. Some architectures do not separate the integration element from the physical entity [12], [19], [20], [27], [31] or the data management and information element [24]. We see data about the physical entity not necessarily coming from the physical entity itself, as demonstrated in the validation example of the medical mechatronic product collision avoidance application. The data management can also be handled separately from the origin of the data; hence, the integration element is considered a separate element in our reference architecture model.



The data management and information element is considered by other architectures as unified repository [12], data management platform [20], description section [21], data storage [22], data and systems of record [23], data update and aggregation [25], local data repositories and cloud-based information repositories [26], data ingestion and preparation layer [28], information layer [30], and digital layer [31]. Several architectures combine the data management and information element with the modeling and simulation element [27], [29], [31] or the integration element [24]. We consider allocating the data management and information element independent from other elements. This was demonstrated in the mechatronic product and healthcare validation examples, where the data management and information element was allocated on different dependability levels. This requires the element to be separate from the other elements, hence its distinction from other elements in our reference architecture model.

The modeling and simulation element is often referred to as the core element of a Digital Twin. In other architectures, it goes by virtual product [12], virtual shop floor [19], virtual entity platform [20], causal network [21], simulation and analysis [22], simulation modelling and analytics and AI [23], process models layer and data analysis layer [24], emulation and simulation [26], model management layer [28], and functional layer [30]. Besides the previously mentioned overlapping functionalities to the data management and information element, some architectures consider decision and user interfacing functionalities within their modelling and simulation element [25], [26], [30]. We see decision and user interfacing functionalities applicable in different simultaneous types on different dependability levels, hence the independent functional element in our reference architecture model.

Other architectures specify the decision and user interfacing element as shop floor service system [19], service platform [20], artificial intelligence and user interface [22], visualization and process management [23], decision making layer [24], interaction layer [27], service management layer, twin management layer and user interaction layer [28], user entity [29], business layer [30], and application layer [31]. We see the user interaction often being the decision input and therefore decided to merge these two aspects into one functional element. Nevertheless, applications with separate decision and user interfacing elements can be visualized with this article's reference architecture model by instantiating two separate building blocks within the element, one responsible for decision making and one for user interaction.

The communication element is considered by some architectures at a specific point in the architecture [25], [26], [30], [31]. We see communication as an essential part of any Digital Twin application, which is ubiquitously distributed across all functional elements, as also proposed by [19], [22], [23], [29]. We, therefore, consider it in the reference architecture model in the form of communication arrows between the functional elements. Communication hardware can be attributed to the physically closest functional element.

The presented functional elements are a common denominator across the researched architectures. The naming of these elements was conducted to enable an intuitive understanding of what these elements do. Future work can look into a more detailed definition of these elements as the field of Digital Twin further develops.

Additional elements proposed by some architectures, such as security [22], [23], and governance [23], are not explicitly considered within our reference architecture model but can be implicitly built into an application's architecture through careful development and allocation of the other functional elements. Security, for example, is a ubiquitous undertaking spread across functional elements. Each element and the group of elements have to consider security in its development's planning and execution phase.

Dependability aspects are considered in many existing architectures. They are often combined with functional aspects, reducing flexibility for different applications. Manufacturing-based architectures often consider machine and factory level elements [35] or local and cloud elements [25], [31], sometimes enriched with edge elements [26], [27]. Lutze [21] divides his Digital Twin concept into different types of Digital Twin handling personal, pseudonymized, and anonymized data. Tesla's Digital Twin functionalities can be divided into different privacy levels. Some functionalities are "OEM Confidential," and some are "Consumer Accessible," with some data being only on the vehicle level, only in the cloud, or stored on both [48].

Digital Twin applications are often characterized by being highly interconnected. Nevertheless, some applications require high levels of autonomy, reliability, and safety, even in the absence of communication opportunities, such as in deep-sea or space missions [40], [52], [53]. Digital Twins are part of the trend to rely less on human decision-making and more on computational intelligence. This trend bears the challenge of designing dependable, reliable, safe, and secure systems [14], [26]. While some functionalities may require planning to proceed parallel to plan execution, others may not require such low latency. Functionalities can be subdivided into separate Digital Twin applications with different capabilities. Breaking larger Digital Twin applications down into smaller Digital Twin applications with a subset of functionalities reduces complexity and is known as the concept of separation of concerns [26]. The development and visualization of Digital Twin applications with different levels of dependability and their interplay are possible with our reference architecture model.

We purposely leave the definition of specific dependability levels open to enable the use of this reference architecture model for all kinds of applications. Our Digital Twin reference architecture model can visualize all the existing architectures. The existing architectures with dependability aspects are showcased in Table 3. Different dependability level categorizations are demonstrated in the six validation examples. The medical mechatronic product example uses the dependability levels: device level, room/factory level, and cloud

level. The precision medicine example applies the dependability levels: personal, pseudonymized, and anonymized data. Other levels are possible; the examples are only given to showcase applicability and inspire usage for different applications. One limitation of this article's reference architecture model is that simultaneous clustering into different dependability aspects such as privacy and safety is currently impossible. However, we propose that, if necessary, integrating such aspects into a fourth dimension could be done through color-coding. Future work can look into other ways of visualizing different dependability aspects simultaneously.

The life cycle aspect of Digital Twin applications is mentioned by several research works [8], [9], [15], [16] but considered in a Digital Twin architecture only by Aheleroff *et al.* [31]. Their architecture highlights Digital Twin applications' agile and iterative development process along their value life cycle dimension. A Digital Twin application can develop and mature over time. All development stages can be represented with our reference architecture model through different combinations of functional elements and their levels of complexity at different positions in the reference architecture model. Nevertheless, our reference architecture model cannot visualize these development stages simultaneously. Future work can look into integrating the iteratively improving aspect of Digital Twin applications.

The life cycle dimension in our reference architecture model refers to the life cycle of the physical entity and not of the Digital Twin concept itself. With a virtual entity representing its physical entity, the data sources, models, and functionalities can differ across the life cycle stages of a physical twin. Some applications may require data from across the life cycle stages, as demonstrated in the six validation examples. A similar application is mentioned by Sifakis [54] as design-time knowledge and run-time knowledge of autonomous systems. With Parrott and Warshaw [17] advocating broad Digital Twin applications over deep ones, we see the integration of cross-physical twin life cycle Digital Twin aspects as essential for the reference architecture model.

Digital Twin applications with different capabilities ([24], [28]) can be represented by our reference architecture model. A simple Digital Twin application might only consist of a few data sources, a simple data model, human decision-making, and no automated feedback loop. In contrast, a more complex Digital Twin application combines numerous data sources into complex simulation models, makes decisions on its own, and sends commands back to its physical twin. Both complexities of Digital Twin applications can be visualized with our reference architecture model in the form of different implementations of the functional elements, dependability levels, and life cycle stages. Besides the elements' location and interplay, their capabilities can be described in more detail and represent different complexities of Digital Twin applications. For example, a modeling and simulation element can simply aggregate and visualize data or use historical and real-time data from several Digital Twins to predict future behaviors.

The reference architecture model proposed in this article can be applied to Digital Twin use cases across industries and is, therefore, use case-independent. Its applicability was demonstrated with validation examples from six different industries. If some Digital Twin use cases are not yet representable with this reference architecture model, future work can adapt the reference architecture model to achieve universal applicability.

The versatile applicability of the proposed reference architecture model allows researchers and developers to more easily design Digital Twin applications and compare them to each other. Such a flexible yet rigid architecture model serves as a foundation for critical analyses and discussions of different kinds of Digital Twin applications. We hope that this Digital Twin reference architecture model serves as or develops into a cornerstone of Digital Twin development that consolidates the field of Digital Twin as the RAMI4.0 did for the field of IoT.

This Digital Twin reference architecture model serves as the next step in a series of publications aiming at facilitating the development of Digital Twin applications across industries (Figure 11). Newrzella *et al.* [13] propose a methodology for identifying promising Digital Twin use cases and prioritizing them based on estimated value, effort, and scalability. That article extends this work by proposing a structured approach for developing an architecture for Digital Twin applications concerning functionality, dependability, and life cycle aspects for the prioritized Digital Twin use cases. Finally, Newrzella *et al.* [4] serves as a guideline for describing and categorizing Digital Twin applications across industries based on five dimensions. This guideline helps to properly communicate Digital Twin capabilities and manage stakeholders' expectations along the entire Digital Twin development cycle.

For example, this framework can be used by innovation departments with direct access to stakeholders, such as the Siemens Healthineers Innovation Think Tank [55]. Conducting a broad stakeholder needs and opportunities analysis and co-ideating potential solutions with stakeholders for identifying promising Digital Twin use cases is a solid foundation for further development of Digital Twin applications. Co-creation with product stakeholders, and therefore adding the knowledge of the physical entity and the existing infrastructure to the analysis, results in prioritized Digital Twin use cases and product data sources. These steps enable the design of a comprehensive Digital Twin architecture considering functionality, dependability, and life cycle aspects with an increased probability of profitable and scalable Digital Twin applications.

This section highlighted the need for the reference architecture model and its advantages over other three-dimensional architectures. The three dimensions were compared to other Digital Twin architectures, these architectures' shortcomings were discussed, how the reference architecture model addresses these, and what limitations the model has. Aspects from other architectures that are not directly

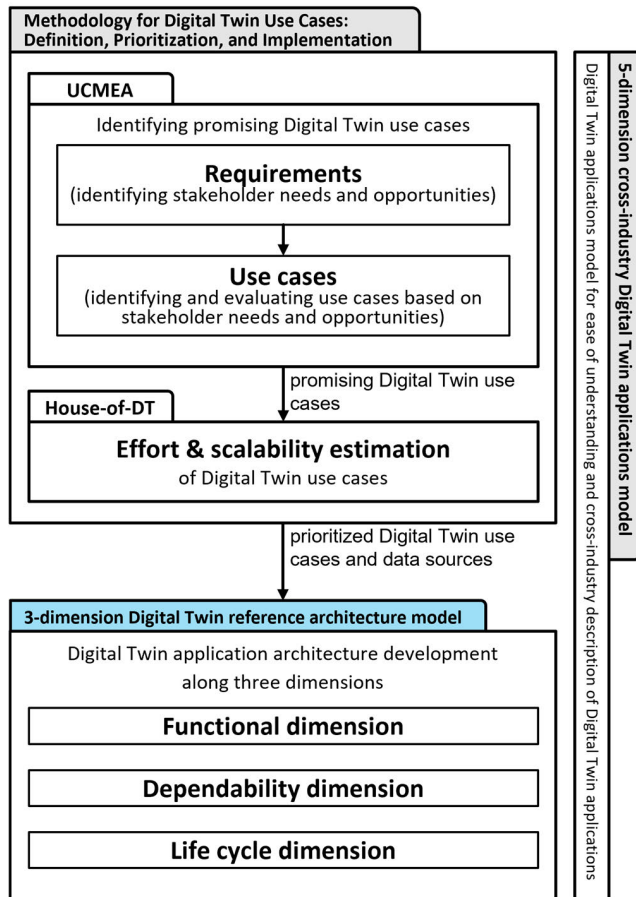

**FIGURE 11.** Schematic of the role of this reference architecture model within the authors' Digital Twin framework.

considered in this article's reference architecture model were mentioned, and it was described how these could be indirectly considered in this article's model. Finally, we discussed the positioning of this article within our previous work on Digital Twin methodologies and highlighted the applicability within an innovation department.

## VI. CONCLUSION

The Digital Twin concept promises to create new business opportunities, gain insights, and improve the efficiency of products. Research and applications can be found across industries such as Manufacturing, Aviation, Healthcare, Construction, Oil and Gas Industry, and Transportation. Previous research proposed various Digital Twin architectures applicable to their individual domain, not separating functional, dependability, and life cycle aspects of Digital Twin applications. We addressed this research gap by proposing the cross-industry Innovation Think Tank Digital Twin reference architecture model focusing on functional, dependability, and life cycle aspects. Its applicability was showcased in six examples from the fields of mechatronic products, healthcare, construction, transportation, astronautics, and the energy sector.

The reference architecture model was discussed and compared with previous research. The importance of separating the functional and dependability dimension was highlighted, and the necessity for the life cycle dimension was described. The compatibility of the reference architecture model with existing architectures was showcased, and its advantages and limitations were presented.

The reference architecture model allows practitioners to more easily plan, develop, and implement Digital Twin applications, independent of the field, the use case, or the complexity of the application. By applying our model, the practitioner is guided through three dimensions of Digital Twin architecture development, functional elements, dependability levels, and life cycle stages. Considering all three dimensions, the outcome will be a detailed description of a Digital Twin application architecture. The model creates a common platform for practitioners to discuss Digital Twin applications, their architectures, capabilities, and further improvement potentials.

The model purposely leaves distinct dependability levels and life cycle stages open to allow flexibility for various use cases, but it hinders the comparability of different Digital Twin applications. The dependability dimension considers aspects such as safety, security, and privacy. Simultaneous visualization of different dependability aspects with this article's reference architecture model remains an open task and can be addressed in future work.

We see the development of a suitable visualization tool for Digital Twin architectures based on the reference architecture model as a promising next step in consolidating the Digital Twin concept across industries.

## REFERENCES

- [1] F. Tao, H. Zhang, A. Liu, and A. Y. C. Nee, "Digital twin in industry: State-of-the-art," *IEEE Trans. Ind. Informat.*, vol. 15, no. 4, pp. 2405–2415, Apr. 2019, doi: [10.1109/TII.2018.2873186](https://doi.org/10.1109/TII.2018.2873186).
- [2] (2022). G. V. Research. *Digital Twin Market Size, Share & Trends Analysis Report by End Use*. Dublin, Ireland. [Online]. Available: <https://www.researchandmarkets.com/reports/5415584/digital-twin-market-size-share-and-trends>
- [3] M. Gholami Mayani, M. Svendsen, and S. I. Oedegaard, "Drilling digital twin success stories the last 10 years," in *Proc. SPE Norway One Day Seminar*, Apr. 2018, pp. 290–302.
- [4] S. R. Newrzella, D. W. Franklin, and S. Haider, "5-dimension cross-industry digital twin applications model and analysis of digital twin classification terms and models," *IEEE Access*, vol. 9, pp. 131306–131321, 2021, doi: [10.1109/ACCESS.2021.3115055](https://doi.org/10.1109/ACCESS.2021.3115055).
- [5] B. R. Barricelli, E. Casiraghi, and D. Fogli, "A survey on digital twin: Definitions, characteristics, applications, and design implications," *IEEE Access*, vol. 7, pp. 167653–167671, 2019, doi: [10.1109/ACCESS.2019.2953499](https://doi.org/10.1109/ACCESS.2019.2953499).
- [6] M. Farsi, A. Daneshkhan, A. Hosseinian-Far, and H. Jahankhani, *Digital Twin Technologies and Smart Cities*. Cham, Switzerland: Springer, 2020.
- [7] T. R. Wanasinghe, L. Wroblewski, B. K. Petersen, R. G. Gosine, L. A. James, O. De Silva, G. K. I. Mann, and P. J. Warrian, "Digital twin for the oil and gas industry: Overview, research trends, opportunities, and challenges," *IEEE Access*, vol. 8, pp. 104175–104197, 2020, doi: [10.1109/ACCESS.2020.2998723](https://doi.org/10.1109/ACCESS.2020.2998723).
- [8] K. Y. H. Lim, P. Zheng, and C.-H. Chen, "A state-of-the-art survey of digital twin: Techniques, engineering product lifecycle management and business innovation perspectives," *J. Intell. Manuf.*, vol. 31, pp. 1313–1337, Nov. 2019, doi: [10.1007/s10845-019-01512-w](https://doi.org/10.1007/s10845-019-01512-w).

- [9] F. Tao, J. Cheng, Q. Qi, M. Zhang, H. Zhang, and F. Sui, "Digital twin-driven product design, manufacturing and service with big data," *Int. J. Adv. Manuf. Technol.*, vol. 94, nos. 9–12, pp. 3563–3576, Feb. 2018, doi: 10.1007/s00170-017-0233-1.
- [10] B. R. Barricelli, E. Casiraghi, J. Gliozzo, A. Petrini, and S. Valtolina, "Human digital twin for fitness management," *IEEE Access*, vol. 8, pp. 26637–26664, 2020, doi: 10.1109/ACCESS.2020.2971576.
- [11] T. Erol, A. F. Mendi, and D. Dogan, "The digital twin revolution in healthcare," in *Proc. 4th Int. Symp. Multidisciplinary Stud. Innov. Technol. (ISMSIT)*, Oct. 2020, pp. 1–7, doi: 10.1109/ISMSIT50672.2020.9255249.
- [12] M. Grieves. (2015). *Digital Twin?: Manufacturing Excellence through Virtual Factory Replication*. White Paper. [Online]. Available: [https://www.researchgate.net/publication/275211047\\_Digital\\_Twin\\_Manufacturing\\_Excellence\\_through\\_Virtual\\_Factory\\_Replication](https://www.researchgate.net/publication/275211047_Digital_Twin_Manufacturing_Excellence_through_Virtual_Factory_Replication)
- [13] S. R. Newrzella, D. W. Franklin, and S. Haider, "Methodology for digital twin use cases: Definition, prioritization, and implementation," *IEEE Access*, vol. 10, pp. 75444–75457, 2022, doi: 10.1109/ACCESS.2022.3191427.
- [14] "Foundations for innovation in cyber-physical systems," Inst. Standards Technol., Columbia, MD, USA, 2013. [Online]. Available: <https://www.nist.gov/system/files/documents/el/CPS-WorkshopReport-1-30-13-Final.pdf>
- [15] S. Boschert and R. Rosen, "Digital twin—The simulation aspect," in *Mechatronic Futures*, P. Hehenberger and D. Bradley, Eds. New York, NY, USA: Springer, 2016, pp. 59–74.
- [16] M. Grieves and J. Vickers, "Digital twin: Mitigating unpredictable, undesirable emergent behavior in complex systems," in *Transdisciplinary Perspectives on Complex Systems*, F.-J. Kahlen, S. Flumerfelt, and A. Alves, Eds. Cham, Switzerland: Springer, 2016, pp. 85–113.
- [17] A. Parrott and L. Warshaw. (2017). *Industry 4.0 and the Digital Twin: Manufacturing Meets its Match*. New York, NY, USA. [Online]. Available: <https://dupress.deloitte.com/dup-us-en/focus/industry-4-0/digital-twin-technology-smart-factory.html>
- [18] M. Grieves, "Conceptual ideal for PLM," Presentation Product Lifecycle Manage. (PLM) Center, Univ. Michigan, Ann Arbor, MI, USA, Tech. Rep., 2002.
- [19] F. Tao and M. Zhang, "Digital twin shop-floor: A new shop-floor paradigm towards smart manufacturing," *IEEE Access*, vol. 5, pp. 20418–20427, 2017, doi: 10.1109/ACCESS.2017.2756069.
- [20] K. Josifovska, E. Yigitbas, and G. Engels, "Reference framework for digital twins within cyber-physical systems," in *Proc. IEEE/ACM 5th Int. Work. Softw. Eng. Smart Cyber-Physical Syst. (SEsCPS)*, May 2019, pp. 25–31, doi: 10.1109/SEsCPS.2019.00012.
- [21] R. Lütze, "Digital twins in eHealth - : Prospects and challenges focussing on information management," in *Proc. IEEE Int. Conf. Eng., Technol. Innov. (ICE/ITMC)*, Jun. 2019, pp. 1–9, doi: 10.1109/ICE.2019.8792622.
- [22] J. Autiosalo, J. Vepsäläinen, R. Viitala, and K. Tammi, "A feature-based framework for structuring industrial digital twins," *IEEE Access*, vol. 8, pp. 1193–1208, 2020, doi: 10.1109/ACCESS.2019.2950507.
- [23] A. Stanford-Clark, E. Frank-Schultz, and M. Harris. (2019). *What are Digital Twins?*. IBM Developer. Accessed: Jan. 29, 2021. [Online]. Available: <https://developer.ibm.com/technologies/iot/articles/what-are-digital-twins/>
- [24] T. Borangiu, E. Oltean, S. Răileanu, F. Anton, S. Anton, and I. Iacob, "Embedded digital twin for ARTI-type control of semi-Continuous production processes," in *Service Oriented, Holonic and Multi-agent Manufacturing Systems for Industry of the Future* (Studies in Computational Intelligence), 853 rd., T. Borangiu, D. Trentesaux, P. Leitão, A. G. Boggino, and V. Botti, Eds. Cham, Switzerland: Springer, 2020, pp. 113–133.
- [25] S. Răileanu, T. Borangiu, N. Ivănescu, O. Morariu, and F. Anton, "Integrating the digital twin of a shop floor conveyor in the manufacturing control system," in *Service Oriented, Holonic and Multi-agent Manufacturing Systems for Industry of the Future* (Studies in Computational Intelligence), T. Borangiu, D. Trentesaux, P. Leitão, A. G. Boggino, and V. Botti, Eds. Cham, Switzerland: Springer, 2020, pp. 134–145.
- [26] A. J. H. Redelinghuys, A. H. Basson, and K. Kruger, "A six-layer architecture for the digital twin: A manufacturing case study implementation," *J. Intell. Manuf.*, vol. 31, no. 6, pp. 1383–1402, Aug. 2019, doi: 10.1007/s10845-019-01516-6.
- [27] P. Zheng and A. S. Sivabalan, "A generic tri-model-based approach for product-level digital twin development in a smart manufacturing environment," *Robot. Comput.-Integr. Manuf.*, vol. 64, Aug. 2020, Art. no. 101958, doi: 10.1016/j.rcim.2020.101958.
- [28] S. Abburu, A. J. Berre, M. Jacoby, D. Roman, L. Stojanovic, and N. Stojanovic, "COGNITWIN—Hybrid and cognitive digital twins for the process industry," in *Proc. IEEE Int. Conf. Eng., Technol. Innov. (ICE/ITMC)*, Jun. 2020, pp. 1–8, doi: 10.1109/ICE/ITMC49519.2020.9198403.
- [29] *Automation Systems and Integration—Digital Twin Framework for Manufacturing—Part 2?: Reference Architecture*, Standard ISO/DIS 23247–2:2020, 2020.
- [30] G. Steindl, M. Stagl, L. Kasper, W. Kastner, and R. Hofmann, "Generic digital twin architecture for industrial energy systems," *Appl. Sci.*, vol. 10, no. 24, p. 8903, Dec. 2020, doi: 10.3390/app10248903.
- [31] S. Aheleroff, X. Xu, R. Y. Zhong, and Y. Lu, "Digital twin as a service (DTaaS) in industry 4.0: An architecture reference model," *Adv. Eng. Informat.*, vol. 47, Jan. 2021, Art. no. 101225, doi: 10.1016/j.aei.2020.101225.
- [32] W. Kritzing, M. Karner, G. Traar, J. Henjes, and W. Sihn, "Digital twin in manufacturing: A categorical literature review and classification," *IFAC-PapersOnLine*, vol. 51, no. 11, pp. 1016–1022, 2018, doi: 10.1016/j.ifacol.2018.08.474.
- [33] N. Jazdi, "Cyber physical systems in the context of industry 4.0," in *Proc. IEEE Int. Conf. Autom., Quality Test., Robot.*, May 2014, pp. 1–4, doi: 10.1109/AQTR.2014.6857843.
- [34] L. Wang, M. Törngren, and M. Onori, "Current status and advancement of cyber-physical systems in manufacturing," *J. Manuf. Syst.*, vol. 37, pp. 517–527, Oct. 2015, doi: 10.1016/j.jmsy.2015.04.008.
- [35] J. Lee, B. Bagheri, and H.-A. Kao, "A cyber-physical systems architecture for industry 4.0-based manufacturing systems," *Manuf. Lett.*, vol. 3, pp. 18–23, Jan. 2015, doi: 10.1016/j.mfglet.2014.12.001.
- [36] K. M. Alam and A. El Saddik, "C2PS: A digital twin architecture reference model for the cloud-based cyber-physical systems," *IEEE Access*, vol. 5, pp. 2050–2062, 2017, doi: 10.1109/ACCESS.2017.2657006.
- [37] R. Rosen, G. Von Wichert, G. Lo, and K. D. Bettenhausen, "About the importance of autonomy and digital twins for the future of manufacturing," *IFAC-Papers OnLine*, vol. 48, no. 3, pp. 567–572, Jan. 2015, doi: 10.1016/J.IFACOL.2015.06.141.
- [38] G. N. Schroeder, C. Steinmetz, R. N. Rodrigues, R. V. B. Henriques, A. Rettberg, and C. E. Pereira, "A methodology for digital twin modeling and deployment for industry 4.0," *Proc. IEEE*, vol. 109, no. 4, pp. 556–567, Nov. 2020, doi: 10.1109/JPROC.2020.3032444.
- [39] W. Dorst et al., "Umsetzungsstrategie industrie 4.0—Ergebnisbericht der plattform industrie 4.0," Kehrberg Druck Produktion Service, Berlin, Germany, 2015. [Online]. Available: <https://www.bitkom.org/sites/default/files/file/import/150410-Umsetzungsstrategie-0.pdf>
- [40] A. Aniculaesei, J. Grieser, A. Rausch, K. Rehfeldt, and T. Warnecke, "Towards a holistic software systems engineering approach for dependable autonomous systems," in *Proc. 1st Int. Workshop Softw. Eng. AI Auto. Syst.*, May 2018, pp. 23–30, doi: 10.1145/3194085.3194091.
- [41] S. Bensalem, M. Gallien, F. Ingrand, I. Kahloul, and N. Thanh-Hung, "Designing autonomous robots," *IEEE Robot. Autom. Mag.*, vol. 16, no. 1, pp. 67–77, Mar. 2009, doi: 10.1109/MRA.2008.931631.
- [42] L. R. de Souza Queiroz Schoueri, "Enhancement of an X-ray device's automated guided module using a digital twin," M.S. thesis, Technische Universität Darmstadt, Darmstadt, Germany, 2021.
- [43] (2022). *Definition of Dependability*. Oxford Dictionary. Oxford University Press. [Online]. Available: <https://www.lexico.com/en/definition/dependability>.
- [44] (2022). *Definition of Life Cycle*. Cambridge Business English Dictionary. Cambridge Univ. Press. [Online]. Available: <https://dictionary.cambridge.org/dictionary/english/life-cycle>.
- [45] M. Mahmeen, R. D. D. Sanchez, M. Friebe, M. Pech, and S. Haider, "Collision avoidance route planning for autonomous medical devices using multiple depth cameras," *IEEE Access*, vol. 10, pp. 29903–29915, 2022.
- [46] S. Haider, A. Goenka, M. Mahmeen, S. Sunny, T. Phan, S. A. Mehdi, D. M. Hassan, and E. Weber, "A disease pathway framework for pain point identification and elaboration of product requirements across patient care plan using innovation think tank global infrastructure," *Frontiers Public Health*, vol. 10, pp. 1–10, Apr. 2022, doi: 10.3389/fpubh.2022.862384.

- [47] G. Angjeliu, D. Coronelli, and G. Cardani, "Development of the simulation model for digital twin applications in historical masonry buildings: The integration between numerical and experimental reality," *Comput. Struct.*, vol. 238, Oct. 2020, Art. no. 106282, doi: [10.1016/j.compstruc.2020.106282](https://doi.org/10.1016/j.compstruc.2020.106282).
- [48] S. Ried. *Learnings From The Digital Twin's Data Architecture Of Tesla Cloudflight*. [Online]. Available: <https://www.cloudflight.io/en/blog/learnings-from-the-digital-twins-data-architecture-of-tesla/>
- [49] W. Yang, Y. Zheng, and S. Li, "Application status and prospect of digital twin for on-orbit spacecraft," *IEEE Access*, vol. 9, pp. 106489–106500, 2021, doi: [10.1109/ACCESS.2021.3100683](https://doi.org/10.1109/ACCESS.2021.3100683).
- [50] Cybersecurity & Infrastructure Security Agency. *CISA National Cyber Incident Scoring System*. [Online]. Available: <https://www.cisa.gov/uscert/CISA-National-Cyber-Incident-Scoring-System>
- [51] *Industrial Communication Networks—Network and System Security—Part 3–3: System Security Requirements and Security Levels, I.O.*, Standard IEC 62443–3–3, International Electrotechnical Commission (IEC), Geneva, Switzerland, 2019.
- [52] T. Fong and D. Allen. (2018). *Autonomous Systems—NASA Capability Overview*. [Online]. Available: <https://ntrs.nasa.gov/archive/nasa/casi.ntrs.nasa.gov/20180007804.pdf>
- [53] D. P. Watson and D. H. Scheidt, "Autonomous systems," *Johns Hopkins APL Tech. Dig.*, vol. 26, no. 4, pp. 368–376, 2005.
- [54] J. Sifakis, "Autonomous systems—An architectural characterization," in *Models, Languages, and Tools for Concurrent and Distributed Programming*, vol. 11665, M. Boreale, F. Corradini, M. Loreti, and R. Pugliese, Eds. Cham, Switzerland: Springer-Verlag, 2019, pp. 388–410.
- [55] S. Haider. (2021). *Addressing Healthcare Needs With Innovation Think Tank Global Infrastructure and Methodology [White Paper]*. Siemens Healthineers Website. [Online]. Available: <https://www.siemens-healthineers.com/careers/innovation-think-tank/siemens-healthineers-itt-white-paper.pdf>

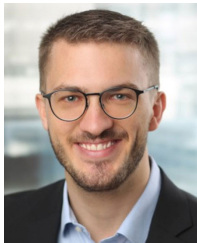

**SEBASTIAN RICHARD NEWRZELLA** received the B.Sc. degree in mechanical and process engineering, the B.Sc. degree in business engineering, and the M.Sc. degree in mechanical and process engineering from the Technical University of Darmstadt, in 2014, 2017, and 2019, respectively. He is currently pursuing the joint Ph.D. degree with the Technical University of Munich and in collaboration with Siemens Healthcare GmbH, Germany. He worked his civilian service in Masatepe, Nicaragua, from 2010 to 2011, where he taught English and German. From 2013 to 2014, he experimentally investigated wet surfaces as a Scientific Assistant with the Center of Smart Interfaces, Technical University of Darmstadt. From 2015 to 2016, he studied and did research on ultrasound transducers at the Nagaoka University of Technology, Niigata, Japan. From 2016 to 2018, he mentored international master's students by giving workshops and offering individual study counseling. In his industrial internship at Philips Medical Systems, Hamburg, Germany, in 2018, he assisted with the introduction of new X-ray devices into production by, among other things, optimizing the production layout and production processes. He joined Siemens Healthineers Innovation Think Tank as a master's Thesis Fellow, in 2019. Within his master's thesis, he used machine learning to analyze patterns in the production of magnetic resonance imaging (MRI) magnets at Siemens Healthcare Ltd., Oxford, U.K. After completing his master's degree, he started working as a Postdoctoral Employee with Siemens Healthineers Innovation Think Tank Mechatronic Products, Kemnath, Germany, where he focuses on innovation projects in the fields of digital twin, machine learning, robotics, and virtual reality.



**DAVID W. FRANKLIN** (Member, IEEE) received the B.Sc. and M.Sc. degrees in human physiology from the Department of Biomedical Physiology and Kinesiology, Simon Fraser University, Canada, and the Ph.D. degree in neuroscience from the Department of Biomedical Physiology and Kinesiology, Simon Fraser University, in 2005. He worked as a Researcher at the Computational Neuroscience Laboratory, Institute for Advanced Telecommunications Research, Kyoto, Japan, from 1999 to 2006. Then, he spent three years as a Postdoctoral Research Associate with the Department of Engineering, University of Cambridge, U.K., where he was awarded the Wellcome Trust Fellowship and became a Research Fellow, in 2010. In 2016, he moved to Munich and became an Associate Professor in neuromuscular diagnostics at the Technical University of Munich.

He investigates the physiological and computational principles of human neuromuscular motor control. His research examines how the nervous system controls the mechanical properties of the body to adapt to our external environment and produce skillful movement. To examine the computations underlying sensorimotor control, he blends computational and experimental approaches including robotics and virtual reality.



**SULTAN HAIDER** is currently the Global Head of Siemens Healthineers Innovation Think Tank (ITT), which was established, in 2005. His inspiring vision of innovation culture formed Innovation Think Tank to become a global infrastructure of 72 activity locations (Innovation Laboratories, Innovation Think Tank certification programs) in Germany, China, U.K., India, USA, United Arab Emirates, Turkey, Canada, Australia, Egypt, Saudi Arabia, Portugal, Switzerland, Brazil, and South Africa. He has filed over 500 inventions and patents and under his leadership, ITT teams have worked on over 2500 technology, strategy, and product definition projects worldwide. He is also a Principal Key Expert at Siemens Healthineers (SHS), a title awarded to him by the SHS Managing Board, in 2008, for his outstanding innovation track record.

Furthermore, he has been awarded honorary directorships, professorships and has developed innovation infrastructures and implemented innovation management certification programs for top institutions.

...