

Received April 18, 2021, accepted April 28, 2021, date of publication May 3, 2021, date of current version May 13, 2021.

Digital Object Identifier 10.1109/ACCESS.2021.3076975

Impedance Bandwidth Improvement of a Planar Antenna Based on Metamaterial-Inspired T-Matching Network

MOHAMMAD ALIBAKHSHIKENARI¹, (Member, IEEE),
 BAL S. VIRDEE², (Senior Member, IEEE), PANCHAM SHUKLA², (Member, IEEE),
 YAN WANG³, (Member, IEEE), LEYRE AZPILICUETA⁴, (Senior Member, IEEE),
 MOHAMMAD NASER-MOGHADASI⁵, CHAN HWANG SEE⁶, (Senior Member, IEEE),
 ISSA ELFERGANI^{7,8}, (Senior Member, IEEE), CHEMSEDDINE ZEBIRI⁹, (Member, IEEE),
 RAED A. ABD-ALHAMEED¹⁰, (Senior Member, IEEE),
 ISABELLE HUYNEN¹⁰, (Senior Member, IEEE),
 JONATHAN RODRIGUEZ¹⁰, (Senior Member, IEEE), TAYEB A. DENIDNI¹¹, (Fellow, IEEE),
 FRANCISCO FALCONE^{12,13}, (Senior Member, IEEE),
 AND ERNESTO LIMITI¹⁰, (Senior Member, IEEE)

¹Electronic Engineering Department, University of Rome "Tor Vergata," 00133 Rome, Italy

²Center for Communications Technology, London Metropolitan University, London N7 8DB, U.K.

³Key Laboratory of Electronic Equipment Structure Design, Ministry of Education, Xidian University, Xi'an 710071, China

⁴School of Engineering and Sciences, Tecnologico de Monterrey, Monterrey 64849, Mexico

⁵Department of Electrical and Computer Engineering, Science and Research Branch, Islamic Azad University, Tehran 14778-93855, Iran

⁶School of Engineering and the Built Environment, Edinburgh Napier University, Edinburgh EH10 5DT, U.K.

⁷Faculty of Engineering and Informatics, University of Bradford, Bradford BD7 1DP, U.K.

⁸Instituto de Telecomunicações, Campus Universitário de Santiago, 3810-193 Aveiro, Portugal

⁹Laboratoire d'Electronique de Puissance et Commande Industrielle (LEPCI), Department of Electronics Engineering, University of Ferhat Abbas, Sétif 19000, Algeria

¹⁰Institute of Information and Communication Technologies, Electronics and Applied Mathematics, Université Catholique de Louvain, 1348 Louvain-la-Neuve, Belgium

¹¹Institut National de la Recherche Scientifique (INRS), University of Quebec, Montréal, QC H5A 1K6, Canada

¹²Electric, Electronic and Communication Engineering Department, Public University of Navarre, 31006 Pamplona, Spain

¹³Institute of Smart Cities, Public University of Navarre, 31006 Pamplona, Spain

Corresponding author: Mohammad Alibakhshikenari (alibakhshikenari@ing.uniroma2.it)

This work was supported in part by the Ministerio de Ciencia, Innovación y Universidades, Gobierno de España (MCIU/AEI/FEDER/UE), under Grant RTI2018-095499-B-C31, in part by the British Council (UK-China-BRI Countries Education Partnership Initiative 2019), in part by the Innovation Programme under Grant H2020-MSCA-ITN-2016 SECRET-722424, and in part by the U.K. Engineering and Physical Sciences Research Council (EPSRC) under Grant EP/E022936/1.

ABSTRACT In this paper a metamaterial-inspired T-matching network is directly imbedded inside the feedline of a microstrip antenna to realize optimum power transfer between the front-end of an RF wireless transceiver and the antenna. The proposed T-matching network, which is composed of an arrangement of series capacitor, shunt inductor, series capacitor, exhibits left-handed metamaterial characteristics. The matching network is first theoretically modelled to gain insight of its limitations. It was then implemented directly in the 50-Ω feedline to a standard circular patch antenna, which is an unconventional methodology. The antenna's performance was verified through measurements. With the proposed technique there is 2.7 dBi improvement in the antenna's radiation gain and 12% increase in the efficiency at the center frequency, and this is achieved over a significantly wider frequency range by a factor of approximately twenty. Moreover, there is good correlation between the theoretical model, method of moments simulation, and the measurement results.

INDEX TERMS T-matching circuit, microstrip antenna, metamaterial, transmission-line, impedance matching.

The associate editor coordinating the review of this manuscript and approving it for publication was Raghvendra Kumar Chaudhary¹⁰.

I. INTRODUCTION

Microstrip antennas have become popular for use in many wireless systems due to their planar profile, ease of

fabrication and low manufacturing cost. Moreover, such antennas allow ease of integration with RF circuit components [1]. As a result, the use of planar based antenna configurations enables the integration of communication capabilities in a wide range of applications in the context of Industry 4.0 technologies such as Internet of Things (IoT) or vehicular communications, among others. This has been made possible by the design of flexible and compact transceivers especially in the sub-6 GHz band for wireless sensor networks (WSN), wireless local area networks (WLAN), public land mobile networks (PLMN) and 5G communication systems. The vast number of applications which make use of wireless communication systems is leading to the need of employing different wireless systems in a cooperative way (i.e., Heterogeneous Network operation), as well as the increase in the allocated channel bandwidth. Optimal performance of these wireless systems is given, among other factors, by adequate transceiver system operation. In relation with antenna sub-systems, impedance matching is one of the main factors to consider in order to reduce reflection-coefficient and hence, increase overall coverage range and minimize overall energy consumption [2]–[7].

The input impedance of an antenna is typically different from the impedance of the system to which it is connected, requiring impedance matching stages in order to minimize losses. In many cases, it is possible to realize impedance matching by modifying the antenna geometry [8]. However, the main limitation of conventional microstrip antennas is their narrow impedance bandwidth (typically less than 3% for reflection-coefficient better than -10 dB). In addition, electrically thin edge-fed microstrip patch antennas usually suffer from high resonant input impedance, typically in a range of 300 – 500Ω , which is challenging to directly match with a 50 - Ω microstrip feedline. To maximize power transfer to and from the antenna, and therefore enhance its radiation efficiency different matching approaches have been investigated previously [9]–[11].

In many wireless applications the matching circuit is not always designed for optimum power transfer between the antenna and transceiver, but consideration is given to maximizing the power handling capability, reducing non-linear distortion and impedance bandwidth. In [12] the matching and impedance bandwidth enhancement is achieved by stacking the radiation patch with a parasitic element. With this technique bandwidth extension of $\sim 19\%$ is possible. In [13], the feeding scheme employed provides an impedance bandwidth of $\sim 28\%$ however the design of the feeding scheme is complex to implement in practice, which has an impact in fabrication cost. In [14], a capacitively coupled probe is used to excite a nonradiative mode close to the antenna's dominant radiation mode to realize a bandwidth of $\sim 28\%$. In [15] multiple resonant modes are simultaneously excited to extend the bandwidth of a patch antenna by about 32% , however this technique is shown to adversely affect the antenna's broadside radiation pattern. In [16] the bandwidth is improved by 15.2% by exciting dual modes.

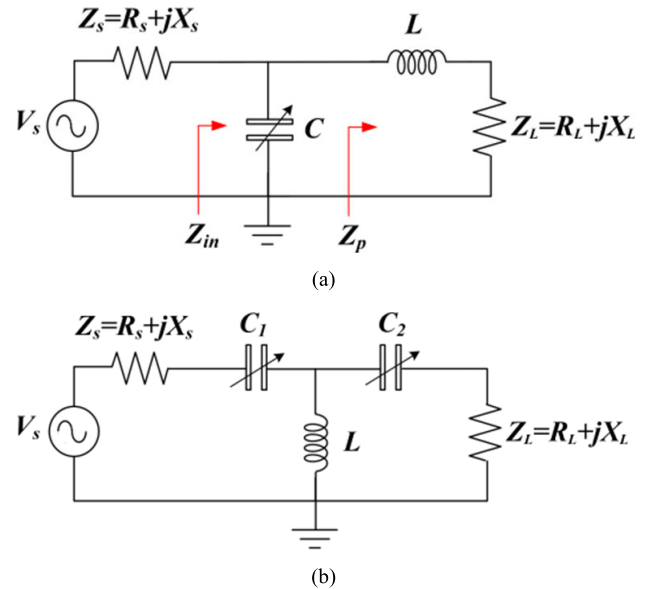

FIGURE 1. (a) Equivalent circuit of L -matching network, and (b) equivalent circuit of T -matching network.

In this paper a simple and effective metamaterial-inspired wideband matching technique is proposed to enhance the radiation gain and efficiency performance of a planar antenna. The proposed matching technique uses a T -matching network consisting of series capacitor, shunt inductor, series capacitor configuration to realize metamaterial characteristics. The matching network is directly embedded inside the feedline of the antenna, which is an unconventional methodology. The technique is first theoretically characterized to gain an understanding of its effectiveness and is then validated through practical design and measurement.

II. IMPEDANCE MATCHED ANTENNA

The three types of lumped element matching networks that are commonly used are based on the L -network, π -network, and T -network. The advantage of L -network is that it only has two reactive components whose values can be tuned easily for a given load impedance. However, its impedance matching capability is limited. On the other hand, the π - or T -networks have the capability of providing superior impedance matching flexibility than the L -network because they have three reactive components that can be tuned.

Fig.1 shows equivalent circuit of a typical L - and T -matching network. The reactive components can be either lumped elements or realized using transmission-lines based on microstrip integrated circuit technology. Capacitors can be realized using interdigital or low impedance microstrip-lines and inductors can be realized using high impedance microstrip-lines. Reactive components realized using microstrip-lines can however result in a larger circuit size.

The reactive components in the network control the reflection-coefficient between the antenna and matching network. In practice the capacitance values are adjusted or tuned

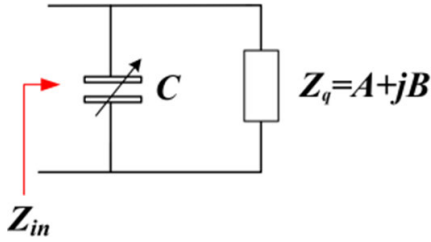

FIGURE 2. Impedance Z_{in} of the L -matching network in Fig.1.

until the reflection-coefficient of the antenna is lower than a specified threshold value, which is typically -10 dB, to (i) reduce system complexity, (ii) maintain the matching performance, and (iii) maximize RF power to the antenna.

To determine the effect of LC reactive components on the input impedance Z_{in} of the L -network in Fig.1(a) the network is first represented in a simplified form in Fig.2, where the impedance Z_q accounts for inductance L and the load impedance $Z_L = R_L + jX_L$.

$$Z_{in} = \frac{\frac{1}{\omega C} (B - jA)}{A + j \left(B - \frac{1}{\omega C} \right)} = R + jX \quad (1)$$

where the real and imaginary impedances are:

$$R = A / \left[(\omega AC)^2 + (\omega BC - 1)^2 \right] \quad (2)$$

$$X = \left[B - \omega C (A^2 + B^2) \right] / \left[(\omega AC)^2 + (\omega BC - 1)^2 \right] \quad (3)$$

By dividing Eqn.(2) by (3) it can be shown that

$$\omega C = (BR - AX) / R (A^2 + B^2) \quad (4)$$

Substituting Eqn. (4) into (2) and (3), it can be shown that

$$\left[R - (A^2 + B^2) / 2A \right]^2 + X^2 = \left[(A^2 + B^2) / 2A \right]^2 \quad (5)$$

where $A = R_L$ and $B = \omega L + X_L$.

Eqn.(5) describes a circle whose center and radius, i.e. the impedance position, is a function of the inductive and capacitive reactance and the load impedance. This equation reveals that the center and radius of the impedance circle can be changed by tweaking either one or both inductance and capacitance in the circuit to effect matching. Unlike the L -network a T -network can provide superior impedance matching because it has three reactive components that can be tuned. In the next section a T -matching circuit is explored in the reduction of mismatch between the antenna and RF front-end circuit.

III. T-COMPENSATION CIRCUIT

In a real-world scenario, the matching network is connected to the antenna using a transmission-line. The proposed T -matching network in Fig.3 comprises an arrangement of series capacitor, shunt inductor, series capacitor. Assuming

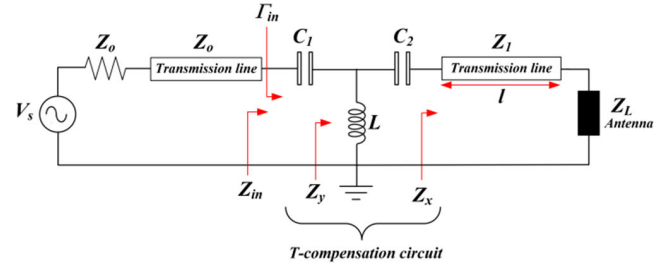

FIGURE 3. Equivalent circuit model of the T -matching network inserted between the source and the antenna.

$C_1 = C_2 = C/2$ it can be shown that the propagation β , the phase velocity v_p , and group velocity v_g are given by [17]

$$\beta = -\frac{1}{\omega \sqrt{LC}} < 0 \quad (6)$$

$$v_p = \frac{\omega}{\beta} = -\omega^2 \sqrt{LC} < 0 \quad (7)$$

$$v_g = \left(\frac{\partial \beta}{\partial \omega} \right)^{-1} = +\omega^2 \sqrt{LC} > 0 \quad (8)$$

Eqn. (7) and (8) show that phase and group velocities are antiparallel, which is characteristic of left-handed metamaterial [17].

The impedance Z_x seen by the signal from the transmitter is a combination of the impedance Z_1 of the transmission-line of length l and the impedance of the antenna load Z_L . Hence, to optimize power transfer between the transmitter to the antenna, we need to conjugately impedance match the impedance Z_{in} looking into the matching circuit to Z_x .

The impedance Z_x looking into the antenna load of impedance Z_L via the transmission-line of length l of impedance Z_1 is given by

$$Z_x = Z_1 \left[\frac{Z_L + jZ_1 \tan \beta l}{Z_1 + jZ_L \tan \beta l} \right] \quad (9)$$

Then

$$Z_y = \frac{\frac{L}{C_2} + j\omega LZ_x}{Z_x + j \left(\frac{\omega^2 LC_2 - 1}{\omega C_2} \right)} \quad (10)$$

The input impedance Z_{in} of the T -compensation circuit, shown in Fig.3, can be represented as $Z_{in} = R_{in} + jX_{in}$, where R_{in} and X_{in} can be determined to be given by

$$R_{in} = \frac{\frac{xL}{t} \left(\frac{1}{C_2} - \frac{\omega y}{t} \right) + \frac{\omega xL}{t} \left[\frac{y}{t} + \left(\frac{\omega^2 LC_2 - 1}{\omega C_2} \right) \right]}{\left(\frac{x}{t} \right)^2 + \left[\frac{y}{t} + \left(\frac{\omega^2 LC_2 - 1}{\omega C_2} \right) \right]^2} \quad (11)$$

$$X_{in} = \frac{\omega L \left(\frac{x}{t} \right)^2 - L \left(\frac{1}{C_2} - \frac{\omega y}{t} \right) \left[\frac{y}{t} + \left(\frac{\omega^2 LC_2 - 1}{\omega C_2} \right) \right]}{\left(\frac{x}{t} \right)^2 + \left[\frac{y}{t} + \left(\frac{\omega^2 LC_2 - 1}{\omega C_2} \right) \right]^2} - \omega C_1 \quad (12)$$

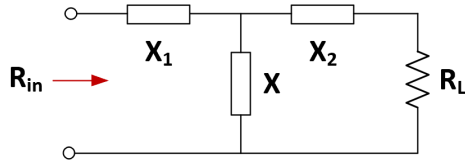

FIGURE 4. T-matching circuit.

where

$$\begin{aligned} x &= Z_L Z_1 (1 + \tan^2 \beta l) \\ y &= \tan^2 \beta l (Z_1^2 - Z_L^2) \\ t &= Z_1^2 + Z_L^2 \tan^2 \beta l \end{aligned}$$

Reflection-coefficient (Γ_{in}) at the input port of the antenna is a measure of how much RF power is reflected from the antenna. This parameter therefore determines how much RF power is radiated by the antenna. It also has an impact on the radiation efficiency of the antenna which is calculated in terms of the ratio of the radiated power to the power delivered to the load. The reflection-coefficient looking at the antenna via the T-compensation circuit is given by:

$$\Gamma_{in} = \frac{R_{in}^2 + X_{in}^2 - Z_o^2 - jR_{in}X_{in}}{(R_{in} + Z_o)^2 + X_{in}^2} \quad (13)$$

where R_{in} and X_{in} are defined by Eqns. (11) and (12). Eqn.(13) indicates that the center frequency and bandwidth of the matching system can be controlled by simply using appropriate values of the capacitances C_1 and C_2 and inductance L . For a T-matching circuit the relationship between bandwidth and reflection-coefficient is derived in [18] to be given by

$$BW \approx \frac{\sqrt{|\Gamma_{in}|}}{1 - |\Gamma_{in}|} \quad (14)$$

Eqn.(14) indicates that by appropriately selecting R_{in} and X_{in} the bandwidth of the matching network can be optimized.

The basic T-match circuit, shown in Fig.4, allows to set impedance transformation ratio and Q-factor/matching bandwidth of circuit independently.

$$Q_1 = \frac{X_1}{R_{in}} \text{ and } Q_2 = \frac{X_2}{R_L} \quad (15)$$

The T-matching circuit can be decomposed to two L-match circuits, as shown in Fig.5. By series-to-parallel transformation as shown in From Fig.6 [19], [20],

$$Q_1 = \frac{R_I}{X_A} \text{ and } Q_2 = \frac{R_I}{X_B} \quad (16)$$

$$R_{in,p} = R_I = R_{in} \left(1 + Q_1^2\right) \text{ and } R_{L,p} = R_I = R_L \left(1 + \frac{1}{Q_2^2}\right) \quad (17)$$

$$X_{1,p} = X_I \left(1 + \frac{1}{Q_1^2}\right) \text{ and } X_{2,p} = X_I \left(1 + \frac{1}{Q_2^2}\right) \quad (18)$$

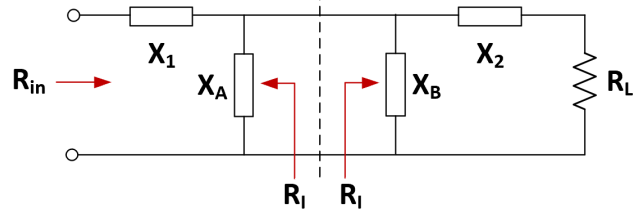

FIGURE 5. T-matching circuit decomposed to two L-match circuits.

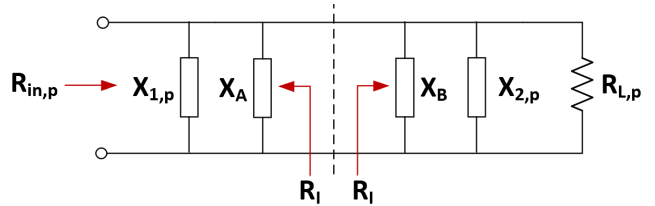

FIGURE 6. T-matching after series to parallel transformation.

Rearranging Eqn.(17)

$$Q_1 = \sqrt{\frac{R_I}{R_{in}} - 1} \text{ and } Q_2 = \sqrt{\frac{R_I}{R_L} - 1} \quad (19)$$

The total Q of the circuit is given by

$$Q = Q_1 + Q_2 = \sqrt{\frac{R_I}{R_{in}} - 1} + \sqrt{\frac{R_I}{R_L} - 1} \quad (20)$$

At resonant frequency, $|X_A| = |X_{1,p}|$ and $|X_B| = |X_{2,p}|$.

Therefore, $X_A = X_1 \left(1 + \frac{1}{Q_1^2}\right)$ and $X_B = X_2 \left(1 + \frac{1}{Q_2^2}\right)$

The above relationships allow the design of the preliminary T-matching circuit. The design procedure involves: (i) finding R_I using Eqn.(20) from given R_L , R_{in} and Q ; (ii) calculating Q_1 and Q_2 using Eqn.(19); (iii) finding X_1 and X_2 using Eqn.(15), and (iv) finding X_A and X_B using Eqn.(16).

The expression for the gain of the circular patch antenna can be determined using [21]

$$G = \eta D \quad (21)$$

where the efficiency η is given by

$$\eta = \frac{P_r}{P_T} \quad (22)$$

where P_r is the radiated power into space, and P_T is the total power delivered to the antenna. This expression indicates that the efficiency of the antenna is independent of frequency. The directivity of the antenna D is given by [22]

$$D = \frac{\frac{1}{2} \text{Re} (E_\theta H_\theta^* - E_\phi H_\phi^*) |_{\theta=0}}{P_r / 4\pi r^2} \quad (23)$$

Taking Eqn.(23) and (22), Eqn.(21) can be written as

$$\begin{aligned} G_e &= \frac{4\pi r^2}{P_T} \cdot \frac{1}{2} \text{Re} (E_\theta H_\theta^* - E_\phi H_\phi^*) |_{\theta=0} \\ &= \frac{4\pi r^2}{P_T} \cdot \frac{1}{2\eta_o} (|E_\theta|^2 + |E_\phi|^2) |_{\theta=0} \end{aligned} \quad (24)$$

where $\eta_o = 120\pi \Omega$ is the free-space impedance.

The far-field electric field components are given by [22]

$$E_{\theta} = j^n \frac{Vak_o}{2r} \cdot \frac{e^{-jk_o r}}{r} \cos n\theta \times [J_{n+1}(k_o a \sin\theta) - J_{n-1}(k_o a \sin\theta)] \quad (25)$$

$$E_{\phi} = j^n \frac{Vak_o}{2r} \cdot \frac{e^{-jk_o r}}{r} \cos \theta \sin n\theta \times [J_{n+1}(k_o a \sin\theta) - J_{n-1}(k_o a \sin\theta)] \quad (26)$$

where $V = hE_o J_n(k_o a)$, h is the thickness of the substrate, a is effective radius of the circular patch, $J_n(ka)$ is the Bessel function of order n and $k_o = \omega/c$.

From Eqn.(25) and (26), for $n = 1$, we obtain

$$(|E_{\theta}|^2 + |E_{\phi}|^2) |_{\theta=0} = \left(\frac{Vak_o}{2r} \right)^2 \quad (27)$$

The expression for effective gain given by Eqn.(24) then becomes

$$G = \frac{\pi}{2\eta_o} (Vak_o)^2 \cdot \frac{1}{P_T} \quad (28)$$

The resonant resistance R can be calculated using

$$R = \frac{V^2}{2P_T} \quad (29)$$

Then from Eqs. (28) and (29),

$$G = \frac{\pi R}{\eta_o} \left(\frac{2\pi a f_r}{c} \right)^2 \quad (30)$$

where f_r is the resonant frequency of the dominant mode (TM₁₁). Eqn.(30) indicates the gain of the circular patch antenna is affected by the power delivered to it.

Assuming $C_1 = C_2 = C/2$ in Fig.3, the ABCD matrix of the T -matching network is given by [23]

$$\begin{bmatrix} \bar{A} & \bar{B} \\ \bar{C} & \bar{D} \end{bmatrix} = \begin{bmatrix} 1 & \bar{X}_c \\ 0 & 1 \end{bmatrix} \begin{bmatrix} 1 & 0 \\ \bar{Y}_L & 1 \end{bmatrix} \begin{bmatrix} 1 & \bar{X}_c \\ 0 & 1 \end{bmatrix} \quad (31)$$

This matrix can be simplified to

$$\begin{bmatrix} \bar{A} & \bar{B} \\ \bar{C} & \bar{D} \end{bmatrix} = \begin{bmatrix} 1 + \bar{X}_c \bar{Y}_L & \bar{X}_c (1 + \bar{X}_c \bar{Y}_L) + \bar{X}_c \\ \bar{Y}_L & 1 + \bar{X}_c \bar{Y}_L \end{bmatrix} \quad (32)$$

where $\bar{X}_c = -j2/\omega CZ_o$ and $\bar{Y}_L = -jZ_o/\omega L$.

The insertion loss is defined as [23]

$$IL = 10 \log \frac{P_{Lb}}{P_{La}} \quad (33)$$

where P_{Lb} is power delivered to the load before inserting the T -matching network, and P_{La} is power delivered to the load after inserting the network. For the two-port T -matching network in Fig.3 that is symmetrical and reciprocal, the following conditions apply [23]

1. $\bar{A} = \bar{D}$
2. $\bar{A}\bar{D} - \bar{B}\bar{C} = 0$
3. \bar{A} & \bar{D} are real
4. $\bar{B} = \bar{C}$ are imaginary

Hence the insertion loss in terms of ABCD matrix is given by [23]

$$IL = 10 \log \left[1 + \left(\frac{\bar{B}}{2j} - \frac{\bar{C}}{2j} \right)^2 \right] \quad (34)$$

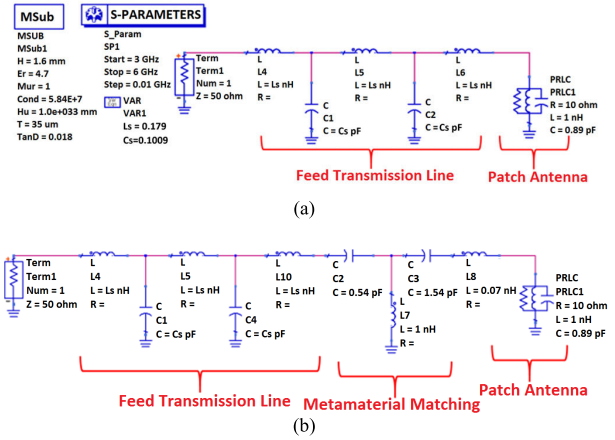

FIGURE 7. (a) Equivalent circuit model of feedline and patch antenna, and (b) circular patch antenna loaded with metamaterial matching network using Keysight Technologies' Advance Design System (ADS).

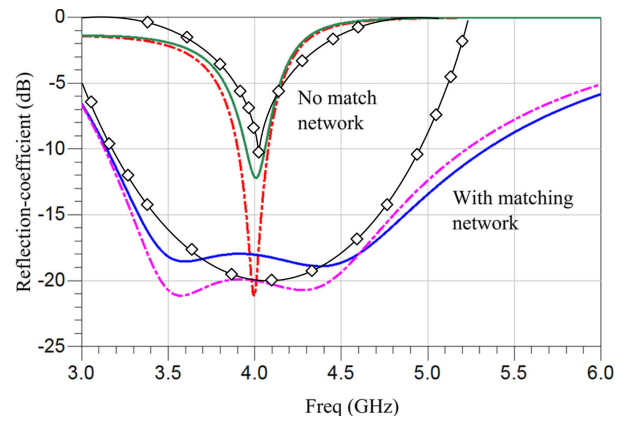

FIGURE 8. Theoretical, simulated and measured reflection-coefficient response of the antenna without and with the metamaterial-inspired matching network. Black diamond studded line is prediction by theory, dotted lines indicate the simulated result, and solid lines represent the measured result.

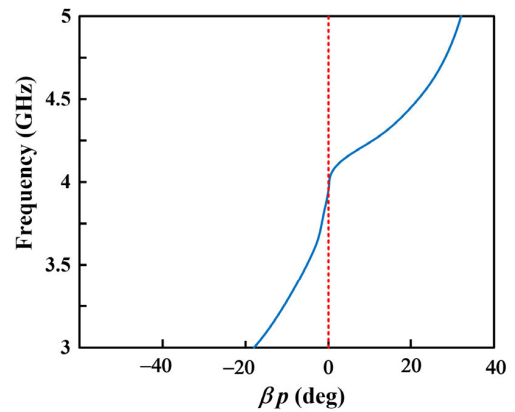

FIGURE 9. Dispersion diagram of the CRLH-TL feedline antenna.

Therefore, the insertion loss introduced by inserting the two-port T -matching network can be shown to be given by

$$IL = 10 \log \left[1 + \left[\frac{2}{\omega C} \left(\frac{1}{\omega^2 LC} - \frac{1}{Z_o} \right) + \frac{Z_o}{2\omega L} \right]^2 \right] \quad (35)$$

TABLE 1. Antenna’s geometrical parameters.

Parameters	Size (mm)
L	54
W	29
R	11.2
L_f	28
W_f	2.47
L_s	2.3
W_s	0.5
Radius of shunt via-hole	0.5
Thickness of FR-4 substrate	1.6

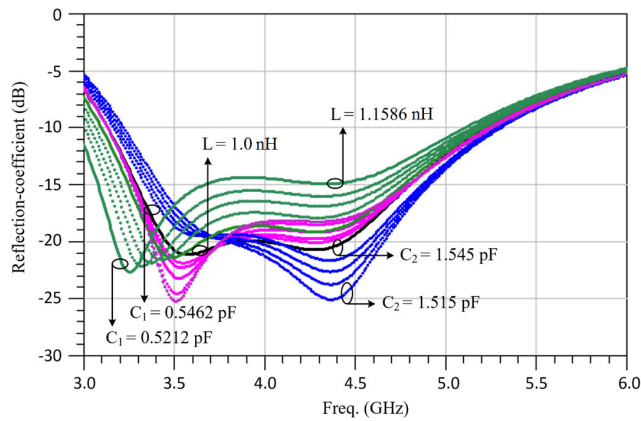

FIGURE 10. Effect on the reflection-coefficient response by the T-matching network parameters.

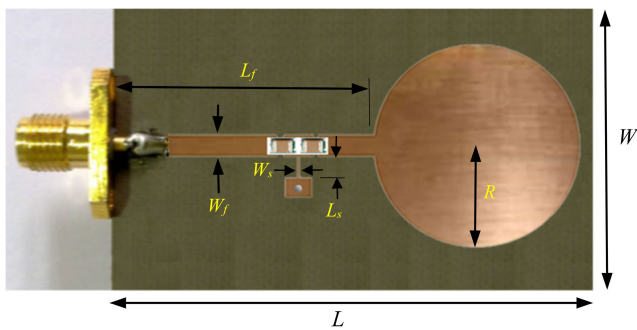

FIGURE 11. Photograph of the microstrip antenna incorporating the T-matching circuit.

The gain of the T-matching network in Eqn.(30) is therefore affected by the insertion loss which is defined in Eqn.(35)

In the next section it is shown that with proper selection of C_1 , C_2 , and L a high gain and high radiation efficiency can be obtained over a wide frequency band. However, this does introduce some complexity in the design as each variable capacitor needs to be controlled separately. Nevertheless, the proposed technique is amenable to electronic tuning hence allowing controllable matching capability according to system requirements.

IV. DESIGN EXAMPLE USING METAMATERIAL INSPIRED T-MATCHING NETWORK

A standard circular microstrip antenna was designed at 4 GHz using FR-4 lossy substrate with a relative permittivity of 4.3,

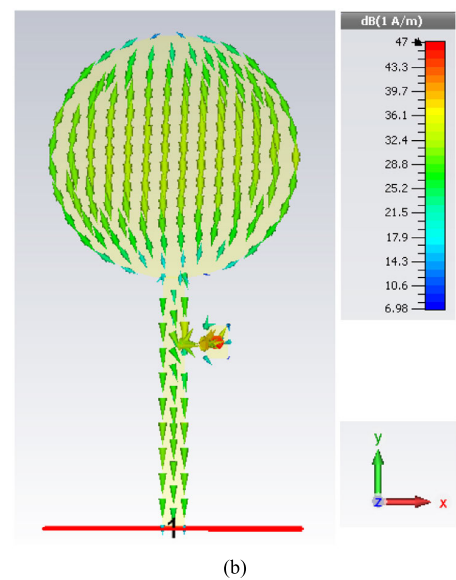
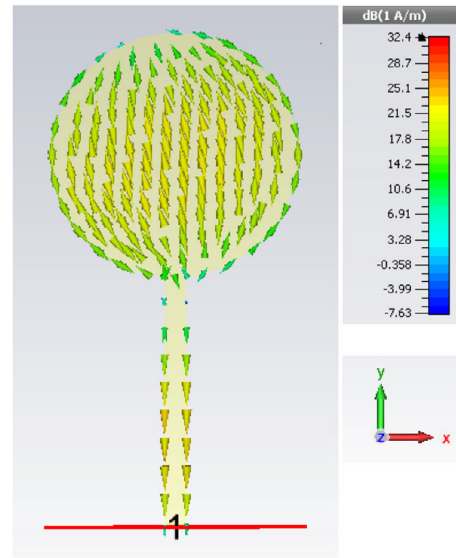

FIGURE 12. Surface current distribution over the antenna at 4 GHz, (a) without the T-matching circuit, and (b) with the T-matching circuit.

thickness of 1.6 mm, and $\tan \delta$ of 0.025. The radius of the circular patch is 11.2 mm. The patch antenna is excited using a microstrip feedline. Fig.7(a) shows the equivalent circuit model of the distributed transmission-line feed and the patch antenna. The LC component values of the feedline were chosen such that its lowpass filter response was well above the resonant frequency of the antenna so that it had no impact on the antenna’s performance. The reflection-coefficient of the antenna predicted by theory and simulation in Fig.8 show it resonates at 4 GHz with a high-Q and hence has a narrow impedance bandwidth. The measured results show a bandwidth of 0.1 GHz for $S_{11} \leq -10$ dB with an optimum reflection-coefficient value of -12 dB at 4 GHz.

Microstrip feedline length determines the input impedance of the antenna. Hence, a T-matching circuit is directly embedded in the feedline, which is an unconventional

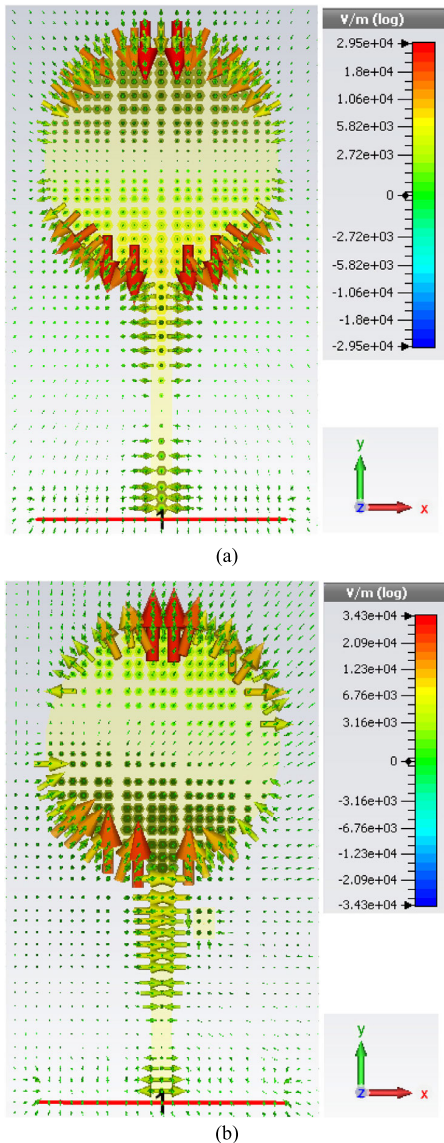

FIGURE 13. E-field distribution over the antenna at 4 GHz, (a) without the *T*-matching circuit, and (b) with the *T*-matching circuit.

technique. The matching circuit used here is a metamaterial structure that exhibits left-handed properties of negative refractive index when interacts with electromagnetic signals [17]. The metamaterial characteristics are realized here with a *T*-network composed of series capacitance, shunt inductance, and series capacitance circuit, as per schematic diagram in Fig.7(b). The dispersion diagram of the antenna with the matching circuit in Fig.9 show the phase variation is virtually zero at 4 GHz. The dispersion diagram was computed using CST Microwave Studio which is 3D electromagnetic simulation tool. The antenna structure was modelled in CST and its boundary conditions, which defines the radiating environment of the model, were set appropriately so that the simulator effectively saw open space around the antenna. The Eigenmode Solver in CST was used to obtain the dispersion diagram as described in [24].

The reflection-coefficient response in Fig.8 by theory, simulation, and measurement show that with the inclusion of

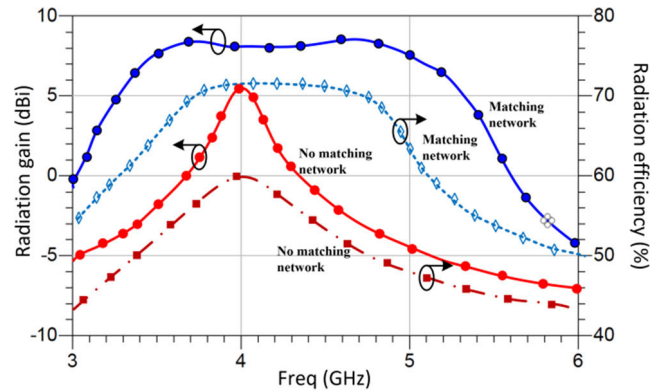

FIGURE 14. Measured radiation gain and efficiency response with and without the embedded *T*-matching circuit.

the metamaterial matching network the antenna’s impedance bandwidth is significantly improved. It is evident from Fig.8 that magnitude of reactive components constituting the *T*-matching circuit have a great influence on the Q-factor of the antenna. The results of the parametric study in Fig.10 show how the parameters constituting the *T*-matching circuit effect the reflection-coefficient response. The optimum values are: $C_1 = 0.5462$ pF, $C_2 = 1.545$ pF and $L = 1.1586$ nH. The fabricated antenna with the matching network is shown in Fig.11. Its measured reflection-coefficient in Fig.8 is better than -18 dB at 4 GHz. The magnitude of the geometrical parameters corresponding to the lumped element values, which are annotated in Fig.11, are given in Table 1.

Simulated current distribution without and with the *T*-matching circuit at 4 GHz is shown in Fig.12. The size and color of the arrow indicate the magnitude and intensity of the current. The rainbow-colored band defines the magnitude of the intensity associated with the color of the arrows. It is evident that the current distribution over the antenna with the *T*-matching circuit results in current concentration at the shorting pin of the matching circuit in the feedline. Despite this the magnitude of the current intensity associated with the colored arrows over the two antennas, i.e., without and with the matching network, as specified in the colored bands show the current intensity is comparable. The E-field distribution over the antenna without and with the *T*-matching circuit is shown in Fig.13. It is observed from this figure that the E-field intensity is strongest at the top and bottom portions of the patch however the E-field intensity is unaffected with the inclusion of the *T*-matching circuit.

The measured radiation gain and efficiency performance without and with the *T*-matching circuit are shown in Fig.14. It is evident from these results that there is substantial improvement in the radiation gain and efficiency by employing the *T*-matching circuit. This is because most of the RF power is delivered to the antenna from the source. Measured results show without the matching circuit the antenna has a peak gain and efficiency of 5.5 dBi and 59.8%, respectively, at 4 GHz. However, with the matching circuit the

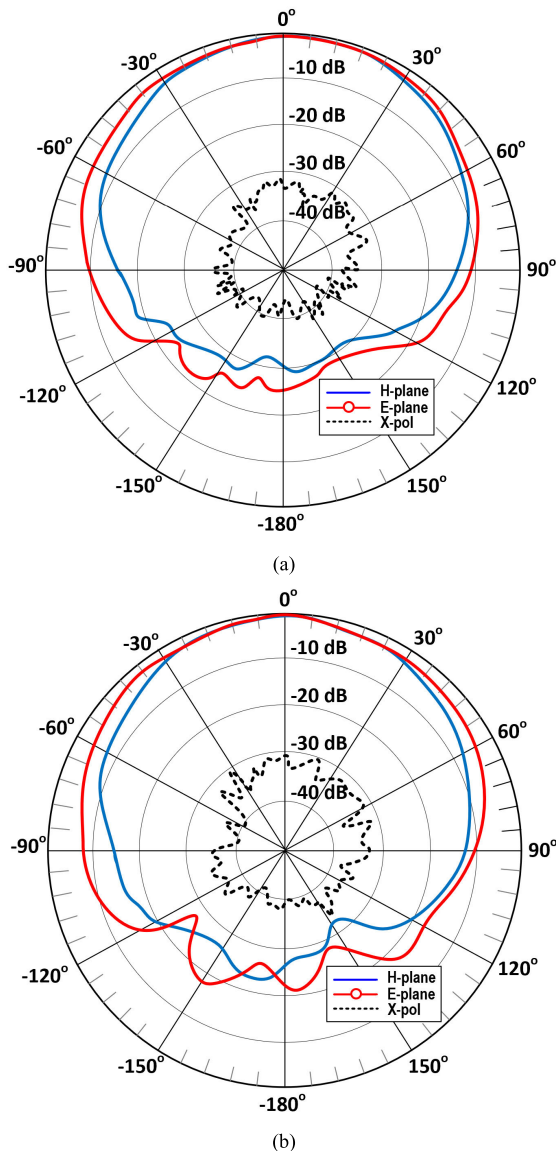

FIGURE 15. The normalized measured radiation pattern in the E-plane and H-plane at 4 GHz, (a) without no matching circuit, and (b) with the embedded T -matching circuit.

peak gain and peak efficiency are 8.2 dBi and 71.8%, respectively. Moreover, the gain and efficiency extend over a significantly larger bandwidth. The gain ≥ 6 dBi extend from 3.35-5.25 GHz, and the efficiency $\geq 60\%$ extend from 3.25-5.1GHz.

The radiation pattern in the E- and H-planes and the cross-polarization without and with the T -matching network at 4 GHz are shown in Fig. 15. The change in the radiation pattern with the T -matching network is marginal and, in both cases, the cross-polarization is less than -30 dB.

Table 2 compares the present technique with some recently reported antenna bandwidth enhancement techniques. Impedance bandwidth enhancement of a microstrip patch antenna in [25] and [26] is achieved by loading the antenna with shorting pins and slots. In [27] the bandwidth is enhanced by simply curving the patch antenna in a partial

TABLE 2. Comparison of the proposed matching technique of recently reported techniques.

Ref.	Technology	Antenna size	Fractional bandwidth (%)	Peak Gain (dBi)	Peak Eff. (%)
25	Shorting pins & slots	$1.14\lambda_0 \times 1.27\lambda_0 \times 0.009\lambda_0$	10	11.8	94
26	Shorting pins & slots	$1.02\lambda_0 \times 1.47\lambda_0 \times 0.045\lambda_0$	8.8 & 4.9	6 & 8	93 & 95
27	Microstrip	$0.58\lambda_0 \times 0.58\lambda_0 \times 0.016\lambda_0$	9	6.28	83.5
28	One-dimensional EM bandgap ground structures & two-stage beam directors	$0.21\lambda_0 \times 0.32\lambda_0 \times 0.009\lambda_0$	32.5	7	95
29	Differential microstrip	$0.8\lambda_0 \times 0.8\lambda_0 \times 0.013\lambda_0$	18.7	8.5	80
30	Magneto-electric dipole	$0.97\lambda_0 \times 0.97\lambda_0 \times 0.17\lambda_0$	28.2	9.0	-
31	Shorting pin & slot	$1.17\lambda_0 \times 1.17\lambda_0 \times 0.055\lambda_0$	32.2	6.5	93
32	Aperture-fed with shorting pins	$1.63\lambda_0 \times 0.82\lambda_0 \times 0.017\lambda_0$	15.2	6.8	-
This work	Metamaterial feedline	$0.67\lambda_0 \times 0.38\lambda_0 \times 0.021\lambda_0$	52.5	8.2	71.8

cylindrical shape. In [28] one-dimensional electromagnetic bandgap ground structures and two-stage beam directors are employed in an inverted-L antenna topology to enhance the bandwidth. Even though the radiation efficiency of the proposed antenna is relatively low compared with the other techniques it is evident from the table that the proposed technique has a comparable gain and exhibits a substantially larger impedance bandwidth. Moreover, its size is relatively small with the exception of [28].

V. CONCLUSION

Impedance bandwidth of an antenna is determined by the matching conditions between the RF transceiver front-end and the antenna. We have demonstrated the effectiveness of employing an embedded metamaterial-based T -matching circuit directly implemented inside the feedline to enhance the antenna's impedance bandwidth. The measured results confirm significant improvement in the antenna's impedance bandwidth over its operating frequency range. Moreover, with the proposed technique improvement was observed in the radiation gain and efficiency too.

REFERENCES

- [1] D. M. Pozar and D. H. Schaubert, *Microstrip Antennas: The Analysis and Design of Microstrip Antennas and Arrays*. Hoboken, NJ, USA: Wiley, 1995.
- [2] N. Engheta, "An idea for thin subwavelength cavity resonators using metamaterials with negative permittivity and permeability," *IEEE Antennas Wireless Propag. Lett.*, vol. 1, pp. 10–13, Jan. 2002.
- [3] M. A. Antoniadis and G. V. Eleftheriades, "Compact linear lead/lag metamaterial phase shifters for broadband applications," *IEEE Antennas Wireless Propag. Lett.*, vol. 2, pp. 103–106, Jul. 2003.
- [4] H. Okabe, C. Caloz, and T. Itoh, "A compact enhanced-bandwidth hybrid ring using an artificial lumped-element left-handed transmission-line section," *IEEE Trans. Microw. Theory Techn.*, vol. 52, no. 3, pp. 798–804, Mar. 2004.
- [5] I. S. Nefedov and S. A. Tretyakov, "On potential applications of metamaterials for the design of broadband phase shifters," *Microw. Opt. Technol. Lett.*, vol. 45, no. 2, pp. 98–102, Apr. 2005.

- [6] M. A. Antoniadis and G. V. Eleftheriades, "A broadband series power divider using zero-degree metamaterial phase-shifting lines," *IEEE Microw. Wireless Compon. Lett.*, vol. 15, no. 11, pp. 808–810, Nov. 2005.
- [7] D. R. Jackson and A. A. Oliner, "Leaky-Wave Antennas," in *Modern Antenna Handbook*, C. A. Balanis, Ed. New York, NY, USA: Wiley, 2008.
- [8] J. C. e Silva, D. F. Mamedes, T. Da Silva Evangelista, and T. R. de Sousa, "Parametric analysis of angular inset-fed in circular microstrip patch antenna," in *IEEE MTT-S Int. Microw. Symp. Dig.*, Porto de Galinhas, Brazil, Nov. 2015, pp. 1–5.
- [9] S. E. Sussman-Fort and R. M. Rudish, "Non-foster impedance matching of electrically-small antennas," *IEEE Trans. Antennas Propag.*, vol. 57, no. 8, pp. 2230–2241, Aug. 2009.
- [10] A. H. Dorrah, M. Chen, and G. V. Eleftheriades, "Bianisotropic Huygens' metasurface for wideband impedance matching between two dielectric media," *IEEE Trans. Antennas Propag.*, vol. 66, no. 9, pp. 4729–4742, Sep. 2018.
- [11] A. Kaya and E. Y. Yüksel, "A discussion on the performance of impedance matched antenna system and considerations for a better performance," *Microw. Opt. Technol. Lett.*, vol. 50, no. 2, pp. 410–415, Feb. 2008.
- [12] M. Arrawatia, M. S. Baghini, and G. Kumar, "Differential microstrip antenna for RF energy harvesting," *IEEE Trans. Antennas Propag.*, vol. 63, no. 4, pp. 1581–1588, Apr. 2015.
- [13] C. Ding and K.-M. Luk, "Low-profile magneto-electric dipole antenna," *IEEE Antennas Wireless Propag. Lett.*, vol. 15, pp. 1642–1644, 2016.
- [14] K. M. Luk, C. L. Mak, Y. L. Chow, and K. F. Lee, "Broadband microstrip patch antenna," *Electron. Lett.*, vol. 34, no. 15, pp. 1442–1443, Jul. 1998.
- [15] H. Wong, K. K. So, and X. Gao, "Bandwidth enhancement of a monopolar patch antenna with V-shaped slot for car-to-car and WLAN communications," *IEEE Trans. Veh. Technol.*, vol. 65, no. 3, pp. 1130–1136, Mar. 2016.
- [16] N.-W. Liu, L. Zhu, W.-W. Choi, and X. Zhang, "A low-profile aperture-coupled microstrip antenna with enhanced bandwidth under dual resonance," *IEEE Trans. Antennas Propag.*, vol. 65, no. 3, pp. 1055–1062, Mar. 2017.
- [17] C. Caloz, T. Itoh, *Electromagnetic Metamaterials: Transmission Line Theory and Microwave Applications: The Engineering Approach*. Hoboken, NJ, USA: Wiley, 2006.
- [18] J. Xi and H. Zhu, "UHF RFID impedance matching: T-match-dipole tag design on the highway," in *Proc. IEEE Int. Conf. RFID (RFID)*, Apr. 2015, pp. 86–93.
- [19] Y. Han and D. J. Perreault, "Analysis and design of high efficiency matching networks," *IEEE Trans. Power Electron.*, vol. 21, no. 5, pp. 1484–1491, Sep. 2006, doi: 10.1109/TPEL.2006.882083.
- [20] P. L. D. Abrie, *The Design of Impedance-Matching Networks for Radio-Frequency and Microwave Amplifiers*. Norwood, MA, USA: Artech House, 1985.
- [21] I. J. Bahl and P. Bhartia, *Microstrip Antennas*. Dedham, MA, USA: Artech House, 1980.
- [22] J. S. Roy and B. Jecko, "Simplified design for a circular microstrip patch antenna," *Microw. Opt. Technol. Lett.*, vol. 6, no. 3, 1993, pp. 201–205.
- [23] P. A. Rizzi, *Microwave Engineering—Passive Circuits*. Upper Saddle River, NJ, USA: Prentice-Hall, 1988.
- [24] [Online]. Available: https://my.ece.utah.edu/dschurig/7/ECE_5350_and_6350_Fall_2014/Assignment_1.html
- [25] N.-W. Liu, L. Zhu, W.-W. Choi, and X. Zhang, "A low-profile differential-fed patch antenna with bandwidth enhancement and sidelobe reduction under operation of TM_{10} and TM_{12} modes," *IEEE Trans. Antennas Propag.*, vol. 66, no. 9, pp. 4854–4859, Sep. 2018.
- [26] N.-W. Liu, L. Zhu, Z.-X. Liu, and Y. Liu, "Dual-band single-layer microstrip patch antenna with enhanced bandwidth and beamwidth based on reshaped multiresonant modes," *IEEE Trans. Antennas Propag.*, vol. 67, no. 11, pp. 7127–7132, Nov. 2019.
- [27] G. Muntoni, G. Montisci, G. A. Casula, F. P. Chietera, A. Michel, R. Colella, L. Catarinucci, and G. Mazzarella, "A curved 3-D printed microstrip patch antenna layout for bandwidth enhancement and size reduction," *IEEE Antennas Wireless Propag. Lett.*, vol. 19, no. 7, pp. 1118–1122, Jul. 2020.
- [28] J.-Y. Lee, J. Choi, J.-H. Jang, and W. Hong, "Performance enhancement in compact inverted-L antenna by using 1-D EBG ground structures and beam directors," *IEEE Access*, vol. 7, pp. 93264–93274, 2019.



MOHAMMAD ALIBAKHSHIKENARI (Member, IEEE) was born in Mazandaran, Iran, in 1988. He received the Ph.D. degree (Hons.) in electronic engineering from the University of Rome Tor Vergata, Italy, in February 2020. In 2018 for eight months, he was working with the Antenna System Division, Department of Electrical Engineering, Chalmers University of Technology, Gothenburg, Sweden, as a Ph.D. Visiting Researcher. His training during the Ph.D. included a research stage

in the Swedish company Gap Waves AB that is developing components in a technology. During his Ph.D. research period, he has participated in 14 international IEEE conferences over the world, where he has presented 20 articles mostly in oral presentations. In August 2019, he gave an invited lecture entitled "Metamaterial Applications to Antenna Systems" at the Department of Information and Telecommunication Engineering, Incheon National University, Incheon, South Korea, which was in conjunction with the 8th Asia-Pacific Conference on Antennas and Propagation (APCAP 2019), where he was the Chair of the Metamaterial session as well. The following research lines have produced more than 100 publications on refereed-international journals, presentations within international-conferences, and book chapters with a total number of the citations more than 1650, H-index of 28, and I10-index of 51 reported by the Google Scholar Citation. His research interests include antennas and wave-propagations, phased antenna arrays, metamaterials and metasurfaces, synthetic aperture radars (SAR), multiple-input multiple-output (MIMO) systems, waveguide slotted antenna arrays, substrate integrated waveguides (SIWs), impedance matching circuits, on-chip antennas, microwave components, millimeter-waves and terahertz integrated circuits, and electromagnetic systems. He was a recipient of two Young Engineer Prizes of the 47th and 48th European Microwave Conference (EuMC), in 2017, Nuremberg, Germany, where he had presented his articles, Madrid, Spain, in 2018. In April 2020, his article entitled "High-Gain Metasurface in Polyimide On-Chip Antenna Based on CRLH-TL for Sub Terahertz Integrated Circuits" (Scientific Reports) was awarded as the Best Month Paper at the University of Bradford, U.K. He was a recipient of two years Postdoctoral Research Grant awarded by the Electronic Engineering Department, University of Rome Tor Vergata, in November 2019. He was also a recipient of International Postgraduate Research (Ph.D.) Scholarship (IPRS) from Italian Government, in 2016 for three years. During his Ph.D. studies, he was a winner of 13 grants for participating in the European Doctoral and Postdoctoral Schools on Antennas and Metamaterials, organized by several European Universities and European School of Antennas (ESoA). He acts as a referee in several high reputed journals and IEEE international conferences. He is serving as an Associate Editor for *Journal of Engineering* (IET), and as a Guest Editor for two special issues entitled "Millimeter-wave and Terahertz Applications of Metamaterials" and "Innovative Antenna Systems: Challenges, Developments, and Applications" in applied sciences and electronics, respectively.



BAL S. VIRDEE (Senior Member, IEEE) received the B.Sc. and M.Phil. degrees in communications-engineering from the University of Leeds, U.K., and the Ph.D. degree in electronic-engineering from the University of London, U.K. He has worked in industry for various companies, including Philips, U.K., as a Research and Development Engineer, and Filtronic-Components Ltd., as a Future Products Developer in the area of RF/microwave communications. He has taught at

several academic institutions, before joining London Metropolitan University, where he is currently a Professor of microwave-communications with the Faculty of Life Sciences and Computing, where he heads the Center for Communications-Technology, and the Director of London Metropolitan-Microwaves. His research, in collaboration with industry and academia, is in the area of microwave wireless communications encompassing mobile-phones to satellite-technology. He is a Fellow of IET. He is an Executive Member of IET's Technical and Professional Network Committee on RF/Microwave-Technology. He has chaired technical sessions at IEEE international conferences and published numerous research-papers.



PANCHAM SHUKLA (Member, IEEE) received the B.E. and M.E. degrees in electronic engineering from the BVM Engineering College, Sardar Patel University, Vallabh Vidyanagar, India, in 1995 and 2001, respectively, the M.Phil. degree in electronic and electrical engineering from the University of Strathclyde, Glasgow, U.K., in 2003, and the Ph.D. degree from Imperial College London, London, U.K., in March 2007. From April 1996 to October 2002, he was a Lecturer with the Electronics and Communications Department, G H Patel College of Engineering and Technology, Sardar Patel University, India. He was a Visiting Researcher with the Space Application Centre (SAC-ISRO), Ahmedabad, India, in 2000. He was a Teaching and Research Assistant with the Signal Processing Division, Electronic and Electrical Engineering Department, University of Strathclyde, from October 2002 to October 2003. From November 2003 to November 2006, he was a member of Research Staff with the Communications and Signal Processing Group, Electrical and Electronic Engineering Department, Imperial College London, and a Research Fellow with the Applied Digital Signal and Image Processing Research Centre, University of Central Lancashire, Preston, U.K., from December 2006 to April 2007. He is currently a Senior Lecturer with the Communications Technology Group, Computing, Communications Technology and Mathematics Department, London Metropolitan University, London. His current research interests include theory and applications of wavelets, sampling and approximation, and signal processing for communication systems.



compensation of phased arrays, and integrated analysis of radome-enclosed array antennas.

YAN WANG (Member, IEEE) was born in Shaanxi, China, in 1989. She received the B.S., M.S., and Ph.D. degrees in electromechanical engineering from Xidian University, Xi'an, China, in 2011, 2014, and 2019, respectively. She is currently a Lecturer and a Master Tutor with the School of Information and Control Engineering, Xi'an University of Architecture and Technology. Her main research interests include electromechanical coupling of array antennas, performance

compensation of phased arrays, and integrated analysis of radome-enclosed array antennas.



MOHAMMAD NASER-MOGHADASI was born in Saveh, Iran, in 1959. He received the B.Sc. degree in communication engineering from Leeds Metropolitan University (formerly Leeds Polytechnic), U.K., in 1985, and the Ph.D. degree from the University of Bradford, U.K., in 1993. From 1985 to 1987, he worked as an RF Design Engineer with Gigatech Company, Newcastle Upon Tyne, U.K. In 1995, he joined Islamic Azad University, Science and Research Branch, Iran, where he is

currently a Full Professor and the Head of the Department of Computer and Electrical Engineering. He has so far published over 200 articles in different journals and over 200 papers in different conferences. His main research interests include microstrip antenna, microwave passive and active circuits, and RF MEMS. From 1987 to 1989, he was awarded a Full Scholarship by the Leeds educational authority to pursue the M.Phil. degree studying in CAD of microwave circuits.



CHAN HWANG SEE (Senior Member, IEEE) received the B.Eng. degree (Hons.) in electronic, telecommunication and computer engineering and the Ph.D. degree from the University of Bradford, U.K., in 2002 and 2007, respectively. He was a Senior Research Fellow with the Antennas and Applied Electromagnetics Research Group, University of Bradford. He was a Senior Lecturer (Programme Leader) in electrical and electronic engineering with the School of Engineering, University of Bolton, U.K. He is currently an Associate Professor and the Head of electrical engineering and mathematics with the School of Engineering and the Built Environment, Edinburgh Napier University, U.K. He is also a Chartered Engineer. He has published over 100 peer-reviewed journal articles in these research areas. He has coauthored one book and three book chapters. His research interests include wireless sensor network system design, computational electromagnetism, antennas, microwave circuits, and acoustic sensor design. He is a Fellow of the Institution of Engineering and Technology and the Higher Education Academy. He was a recipient of two Young Scientist awards from the International Union of Radio Science (URSI) and Asia-Pacific Radio Science Conference (AP-RASC), in 2008 and 2010, respectively. He was awarded the Certificate of Excellence for his successful knowledge transfer partnership (KTP) with Yorkshire Water, on the design and implementation of a wireless sensor system for sewerage infrastructure monitoring, in 2009. He is an Associate Editor for IEEE Access and PeerJ Computer Science Journals.

He is currently an Associate Professor and the Head of electrical engineering and mathematics with the School of Engineering and the Built Environment, Edinburgh Napier University, U.K. He is also a Chartered Engineer. He has published over 100 peer-reviewed journal articles in these research areas. He has coauthored one book and three book chapters. His research interests include wireless sensor network system design, computational electromagnetism, antennas, microwave circuits, and acoustic sensor design. He is a Fellow of the Institution of Engineering and Technology and the Higher Education Academy. He was a recipient of two Young Scientist awards from the International Union of Radio Science (URSI) and Asia-Pacific Radio Science Conference (AP-RASC), in 2008 and 2010, respectively. He was awarded the Certificate of Excellence for his successful knowledge transfer partnership (KTP) with Yorkshire Water, on the design and implementation of a wireless sensor system for sewerage infrastructure monitoring, in 2009. He is an Associate Editor for IEEE Access and PeerJ Computer Science Journals.



ISSA ELFERGANI (Senior Member, IEEE) received the M.Sc. and Ph.D. degrees in electrical and electronic engineering from the University of Bradford, U.K., in 2008 and 2013, respectively. In 2013, he was working as a Postdoctoral Researcher and then as a Investigador Junior at the Instituto de Telecomunicações Aveiro, Portugal, within the Mobile Systems Group. In 2019, he received a contract "Investigador Júnior." He has been involved in several Research and Development projects, such as Agile RF Transceivers and Front-Ends for Future Smart Multi-Standard Communications Applications (ARTEMOS), where he was the Task Leader of "Development of tunable filters and tunable resonators" and a Technical Responsible Investigator of designing the RF tunable bandpass filter operating over a wide continuous frequency range from 1800 MHz to 2600 MHz for use in GSM and LTE applications, Green Terminals for Next Generation Wireless Systems (GREEN-T), where IT were the Coordinator. Best energy efficiency solutions for heterogeneous multi-core communicating systems (BENEFIC) and Coexistence of RF transmissions in the future (CORTIF), where he was the Task Leader of test results and validation in CORTIF project. All projects have been currently successfully concluded. He is working on (5GWAR) novel 5G Millimetre-Wave Array Antennas for Future Mobile Handset Applications as a Principle Investigator and (SECRET): SEcure Network Coding for Reduced Energy nexT generation Mobile Small cells, where his role is the key responsible for the respective technical aspect of 5G Efficient power amplifier, Antenna and Tunable filters within the "WP4-Green RF for 5G Handsets." He has several years of experience in 3G/4G and 5G radio frequency systems research with particular expertise on several and different antenna structures along with novel approaches in accomplishing a size reduction, low cost, improved bandwidth, gain, and efficiency. He is conducting an excellent work towards the 4G/5G single and MIMO antennas, including the physical human interaction, and links to health concerns. Since his Ph.D. graduation, he has successfully completed the supervision of Bolseiro de Investigaçao Científica with title

He is currently an Associate Professor and the Head of electrical engineering and mathematics with the School of Engineering and the Built Environment, Edinburgh Napier University, U.K. He is also a Chartered Engineer. He has published over 100 peer-reviewed journal articles in these research areas. He has coauthored one book and three book chapters. His research interests include wireless sensor network system design, computational electromagnetism, antennas, microwave circuits, and acoustic sensor design. He is a Fellow of the Institution of Engineering and Technology and the Higher Education Academy. He was a recipient of two Young Scientist awards from the International Union of Radio Science (URSI) and Asia-Pacific Radio Science Conference (AP-RASC), in 2008 and 2010, respectively. He was awarded the Certificate of Excellence for his successful knowledge transfer partnership (KTP) with Yorkshire Water, on the design and implementation of a wireless sensor system for sewerage infrastructure monitoring, in 2009. He is an Associate Editor for IEEE Access and PeerJ Computer Science Journals.

“UWB antenna design with Fixed and Tuneable Rejected Frequency Bands” for duration of one year, that led to one book chapter, one journal, and an IEEE conference paper. He is currently co-supervising some Ph.D. students and several Master students. He has around 140 high-impact publications in international conferences, journal articles, and book/book chapters with a Google Scholar H-index 15. Some key works to mention are his three edited books, namely *Antenna Fundamentals for Legacy Mobile Applications and Beyond* (Springer International Publishing AG 2018), *Optical and Wireless Convergence for 5G Networks* (Wiley, IEEE Press, 2019) (ISBN: 978-1-119-49158-3) and *Recent Technical Developments in Energy-Efficient 5G Mobile Cells* (Electronics, Switzerland, 2020) (ISBN 978-3-03936-213-4). He reviewed several good ranked journals, such as IEEE TRANSACTIONS ON VEHICULAR TECHNOLOGY, *IET Microwaves, Antennas and Propagation*, IEEE ACCESS, *Radioengineering Journal*, *IET-SMT*, and *Journal of Engineering* (IET). He is also a member of AASCIT. In 2014, he received the Prestigious FCT Fellowship for his postdoctoral research and the evaluation of the first triennium of this scholarship was given an excellent rating by the evaluators. He was the Chair of 4th, 5th, and 6th (EERT) International workshops. He has been on the Technical Program Committee of a large number of IEEE conferences, including EuCAP for the term 2015–2021 and ITA (15, 17). He is the Guest Editor/Special Issue of *Electronics* “Recent Technical Developments in Energy-Efficient 5G Mobile Cells” (ISSN 2079-9292), and Special Issue on *Recent Advances in Engineering Systems Journal* (ASTESJ) (2017/2019), and a Guest Editor/Special Issue of *Electronics* “Recent Advances in Antenna Design for 5G Heterogeneous Networks” (ISSN 2079-9292).



and complex material components in the microwave and optical domains.

CHEMSEDDINE ZEBIRI (Member, IEEE) received the Ph.D. degree in electronics from the University of Constantine, Algeria, in 2011. Since 2006, he has been with the Department of Electronics, Ferhat Abbas University, Setif, Algeria, where he is currently an Associate Professor. He has published up to 66 journals articles and refereed conference papers. His current research interests include dielectric resonator antennas, MIMO antennas, mmWave antennas, magnetic materials,



frequency, propagation, sensor design, and signal processing, and lead the Communications Research Group for years within the School of Engineering and Informatics, Bradford University. He is also a Principal Investigator for several funded applications to EPSRCs and a leader of several successful knowledge transfer programmes (KTPs), such as with Arris (previously known as Pace plc), Yorkshire Water plc, Harvard Engineering plc, IETG Ltd., Seven Technologies Group, Emkay Ltd., and Two World Ltd. He is a Professor of electromagnetic and radio frequency engineering with the University of Bradford. He has also been a Co-Investigator in several funded research projects, including H2020 MARIE Skłodowska-CURIE ACTIONS: Innovative Training Networks “Secure Network Coding for Next Generation Mobile Small Cells 5G-US,” nonlinear and demodulation mechanisms in biological tissue (Department of Health, Mobile Telecommunications and Health Research Programme, and Assessment of the Potential Direct Effects of Cellular Phones on the Nervous System (EU: collaboration with six other major research organizations across Europe). He has long years of research

RAED A. ABD-ALHAMEED (Senior Member, IEEE) received the B.Sc. and M.Sc. degrees from the University of Basrah, Basrah, Iraq, in 1982 and 1985, respectively, and the Ph.D. degree from the University of Bradford, Bradford, U.K., in 1997, all in electrical engineering. Since September 2009, he has also been a Research Visitor at Wrexham Glyndwr University, Wrexham, U.K., covering the wireless and communications research areas. He is currently the Leader of radio

experience in the areas of radio frequency, signal processing, propagations, antennas, and electromagnetic computational techniques, and has published more than 500 academic journals articles and conference papers, and has coauthored three books and several book chapters. His research interests include computational methods and optimizations, wireless and mobile communications, sensor design, EMC, beam steering antennas, energy-efficient PAs, and RF predistorter design applications. He is a Fellow of the Institution of Engineering and Technology, U.K., and the Higher Education Academy, and a Chartered Engineer, U.K. He received the Business Innovation Award for his successful KTP with Pace and Datong companies on the design and implementation of MIMO sensor systems and antenna array design for service localizations. He is the Chair of several successful workshops on Energy Efficient and Reconfigurable Transceivers: Approach Towards Energy Conservation and CO2 Reduction that addresses the biggest challenges for future wireless systems. He was also appointed as a Guest Editor for *IET Science, Measurements and Technology*, in 2009 and 2012.



ISABELLE HUYNEN (Senior Member, IEEE) received the Ph.D. degree in applied sciences from the Université Catholique de Louvain (UC Louvain), Louvain-la Neuve, Belgium, in 1994. Since 1999, she has been with the FRS-FRNS, Bruxelles, Belgium. She is currently the Research Director and a part-time Professor with UC Louvain. Her current research interests include nanotechnology, nanodevices, and nanomaterials for microwave and millimeter wave applications, including metamaterials, antennas, and absorbers.



JONATHAN RODRIGUEZ (Senior Member, IEEE) received the master's degree (Hons) in electronic and electrical engineering and the Ph.D. degree from the University of Surrey, U.K., in 1998 and 2004, respectively. In 2005, he became a Researcher with the Instituto de Telecomunicações, Portugal, where he was a member of the Wireless Communications Scientific Area. In 2008, he became a Senior Researcher, where he established the 4TELL Research Group targeting next-generation mobile systems. In 2009, he has served as an Invited Assistant Professor for the University of Aveiro, Portugal, and attained an Associate level, in 2015. In 2017, he was appointed as a Professor of mobile communications with the University of South Wales, U.K. He has been a Chartered Engineer (C.Eng.), since 2013. He is currently the Coordinator of the H2020-MSCA-SECRET innovative training networks. He has served as the Project Coordinator for major international research projects, including Eureka LOOP and FP7 C2POWER, whilst serving as a Technical Manager for FP7 COGEU and FP7 SALUS. He has authored more than 500 scientific works, including 11 book editorials. In 2015, he is a Fellow of the IET.



TAYEB A. DENIDNI (Fellow, IEEE) received the M.Sc. and Ph.D. degrees in electrical engineering from Laval University, QC, Canada, in 1990 and 1994, respectively. From 1994 to 2000, he was a Professor with the Department of Engineering, Université du Québec at Rimouski, Rimouski, QC, Canada, where he founded the Telecommunications Laboratory. He founded the RF Laboratory with INRS-EM, Montreal. Since 2000, he has been with the Institut National de la Recherche Scientifique (INRS), Université du Québec at Montreal, Montreal, QC, Canada. He has extensive experience in antenna design and is leading a large research group consisting of three research scientists, eight Ph.D. students, and two M.Sc. students. His current research interests include reconfigurable antennas using EBG and FSS structures, dielectric resonator antennas, metamaterial antennas, adaptive arrays, switched multibeam antenna arrays, ultrawideband antennas, microwave, and development for wireless communications systems. He has served as an Associate Editor for the IEEE ANTENNAS WIRELESS PROPAGATION LETTERS, from 2005 to 2007, and the IEEE TRANSACTIONS ON ANTENNAS AND PROPAGATION, from 2008 to 2010. Since 2015, he has been serving as an Associate Editor for the *Electronics Letters* (IET).



FRANCISCO FALCONE (Senior Member, IEEE) received the degree in telecommunication engineering and the Ph.D. degree in communication engineering from the Universidad Pública de Navarra (UPNA), Spain, in 1999 and 2005, respectively. From February 1999 to April 2000, he was a Microwave Commissioning Engineer at Siemens-Italtel, deploying microwave access systems. From May 2000 to December 2008, he was a Radio Access Engineer at Telefónica Móviles, performing

radio network planning and optimization tasks in mobile network deployment. From February 2003 to May 2009, he was an Assistant Lecturer with the Electrical and Electronic Engineering Department, UPNA. From January 2009 to May 2009, he was the Director of Tafco Metawireless, a spin-off company with UPNA, as a Co-Founding Member. In June 2009, he became an Associate Professor with the Department of Electrical Engineering, where he was the Head of the Department, from January 2012 to July 2018. From January 2018 to May 2018, he was a Visiting Professor with the Kuwait College of Science and Technology, Kuwait. He is currently acting as the Head of the ICT Section. He is also affiliated with the Institute for Smart Cities (ISC), UPNA, which hosts around 140 researchers. He has over 500 contributions in indexed international journals, book chapters, and conference contributions. His research interests include related to computational electromagnetics applied to the analysis of complex electromagnetic scenarios, with a focus on the analysis, design, and implementation of heterogeneous wireless networks to enable context-aware environments. He has been awarded the CST 2003 Best Paper Award and the CST 2005 Best Paper Award, the Ph.D. Award from the Colegio Oficial de Ingenieros de Telecomunicación (COIT), in 2006, the Doctoral Award UPNA, in 2010, the 1st Juan Gomez Peñalver Research Award from the Royal Academy of Engineering of Spain, in 2010, the XII Talgo Innovation Award 2012, the IEEE 2014 Best Paper Award, in 2014, the ECSA-3 Best Paper Award, in 2016, and the ECSA-4 Best Paper Award, in 2017.



ERNESTO LIMITI (Senior Member, IEEE) was a Full Professor of electronics with the Faculty of Engineering, University of Roma Tor Vergata, in 2002, and a Research Assistant and a Teaching Assistant, in 1991, where he has been an Associate Professor, since 1998. He represents the University of Roma Tor Vergata in the governing body of the MECSA (Microwave Engineering Center for Space Applications), an inter-University center among several Italian Universities. He has been

elected to represent the Industrial Engineering Sector at the academic senate of the University for the term 2007–2010 and 2010–2013. He is actively involved in research activities with many research groups, both European and Italian, and is in tight collaborations with high-tech Italian, including Selex-SI, Thales Alenia Space, Rheinmetall, Elettronica S.p.A., and Space Engineering, and foreign, including OMMIC, Siemens, and UMS companies. He contributed, as a Researcher and/or as a unit responsible person, to several National, such as PRIN MIUR, Madess CNR, and Agenzia Spaziale Italiana, and International, such as ESPRIT COSMIC, Manpower, Edge, Special Action MEPI, ESA, EUROPA, Korrigan, and RadioNet FP6 and FP7 projects. Regarding teaching activities, he teaches over his institutional duties in the frame of the corso di laurea magistrale in ingegneria elettronica, “elettronica per lo spazio” within the master’s course in sistemi avanzati di comunicazione e navigazione satellitare. The following research lines have produced more than 250 publications on refereed international journals and presentations within international conferences. His research interests include three main lines, all of them belonging to the microwave and millimetre-wave electronics research area. The first one is related to characterisation and modeling for active and passive microwave and millimetre-wave devices. Regarding active devices, the research line is oriented to the small-signal, noise, and large signal modeling. Regarding passive devices, equivalent-circuit models have been developed for interacting discontinuities in microstrip, for typical MMIC passive components (MIM capacitors), and to waveguide/coplanar waveguide transitions analysis and design. For active devices, new methodologies have been developed for the noise characterisation and the subsequent modeling, and equivalent-circuit modeling strategies have been implemented both for small and large-signal operating regimes for GaAs, GaN, SiC, Si, and InP MESFET/HEMT devices. The second line is related to design methodologies and characterisation methods for low noise circuits. The main focus is on cryogenic amplifiers and devices. Collaborations are currently ongoing with the major radio astronomy institutes all around Europe within the frame of FP6 and FP7 programmes (RadioNet). Finally, the third line is in the analysis methods for nonlinear microwave circuits. In this line, novel analysis methods (spectral balance) are developed, together with the stability analysis of the solutions making use of traditional (harmonic balance) approaches. He is a member of the Committee of the Ph.D. Program in telecommunications and microelectronics at the University of Roma Tor Vergata, tutoring an average of four Ph.D. candidates per year. He is actually the President of the Consortium “Advanced Research and Engineering for Space,” ARES, formed between the University and two companies. Further, he is actually the President of the Laurea and Laurea Magistrale degrees in electronic engineering with the University of Roma Tor Vergata. He acts as a referee of international journals of the microwave and millimetre wave electronics sector and is in the Steering Committee of international conferences and workshops.

• • •