

Received December 21, 2020, accepted January 5, 2021, date of publication January 18, 2021, date of current version January 29, 2021.

Digital Object Identifier 10.1109/ACCESS.2021.3051937

# A Smart Home Architecture for Smart Energy Consumption in a Residence With Multiple Users

SÉRGIO H. M. S. ANDRADE<sup>1,2</sup>, GUSTAVO O. CONTENTE<sup>1</sup>, LUCAS B. RODRIGUES<sup>1</sup>,  
LUIGUY X. LIMA<sup>1</sup>, NANDAMUDI L. VIJAYKUMAR<sup>3,4</sup>, AND CARLOS RENATO L. FRANCÊS<sup>2</sup>

<sup>1</sup>Computer Engineering Area, Estácio Nazaré University, Belém 66055-260, Brazil

<sup>2</sup>Postgraduate Program in Electrical Engineering, Federal University of Pará (UFPA), Belém 66075110, Brazil

<sup>3</sup>National Institute for Space Research (INPE), São José dos Campos 12227-010, Brazil

<sup>4</sup>Institute of Science and Technology, Federal University of São Paulo (UNIFESP), São José dos Campos 12247014, Brazil

Corresponding author: Sérgio H. M. S. Andrade (sergiohmsa@gmail.com)

This work was supported in part by the Coordination for the Improvement of Higher Education (CAPES) under Finance Code 001, and in part by the PROPESP/UFPA-Dean of Research and Graduate Programs of the Federal University of Pará (UFPA).

**ABSTRACT** Smart Energy Control Systems (SECS) has been increasingly implemented in the Smart homes scenario, due to the possibility of conditioning and controlling residential energy consumption, thus contributing to reducing energy losses and unnecessary electrical consumption. With the evolution of embedded systems in conjunction with the Internet of Things (IoT), Smart Outlet (SO), and devices that promote the Users Indoor Identification (UII) environments, they have assumed fundamental roles in the acquisition of data from electrical devices and also in the mapping of the individualized consumption of each resident throughout the day, providing essential information for SECS Systems as a way to assist in energy balance with minimal impact on the daily usability of electrical equipment. However, in most of the works that propose these types of assistance to SECS based on SO and UII, they have a massive implementation of sensors throughout the residence, misinterpretation of the data generated by the residents, difficulty in the identification of multiple residents. Thus, the present work proposes an evolution of an SECS architecture called SmartCom, with the implementation of accurate identification of electrical equipment through Near Field Communication (NFC)-based SO (data transfer between the appliance and the SO) and of multiple inhabitants through Wi-Fi handover using smartphones, with the least possible impact on the user's comfort, as well as in the building structure, achieving a rebalanced residential energy consumption 87.3% of the time it was used.

**INDEX TERMS** Smart energy control systems, smart outlet, user's indoor identification, SmartCom.

## I. INTRODUCTION

The electric power systems have undergone significant changes in the last few years, owing to the introduction of new business formats as in the electrical power distribution system, for example. These formats allow end users to be included in the dynamics of Smart Grid (SG) networking. This interaction results in a complex scenario concerning the services as it raises some serious challenges, for example, the question of how to combine hardware and software features. This is due to the heterogeneous environments in which the power companies and power systems operate, which is, in turn, a key factor when ensuring a suitable level of security.

Therefore, it is recommended that a strategy that is suited to all aspects of the electricity area is to be adopted. Moreover, the new model must satisfy the requirements of the Electricity

Regulatory Authority (such as in the areas of maintenance, control, and supervision), while also fulfilling the following prerequisites: management, controlling, reliability, clean sources of renewable energy generation, cost-effectiveness and interoperability. These attributes are all required within the SG domains [1].

Overall, an SG is a network that can manage electrical equipment and systems in various fields and bring security, viability, efficiency, and quality of service in an intelligent and trustworthy way. There are seven interconnected areas in those fields [2]. The first four (distribution, transmission, end-users, and generation on a large scale) are responsible for generation, transmission, and distribution. To provide full management between customers and the Advanced Metering Infrastructure (AMI), for example, data exchange, these fields must ensure bi-directional communication. The energy managing market, service delivery, and energy supply refer to the last three (operations, market suppliers, and services).

The associate editor coordinating the review of this manuscript and approving it for publication was Macarena Espinilla .

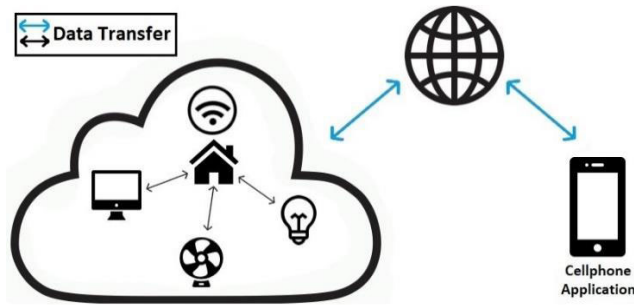

FIGURE 1. IoT architecture in the context of SHs.

The term ‘customer domain’, [3] refers to energy managing on the client side, along with the organization and control of electrical devices to find stability and improve energy consumption at home. The purpose of this article is to tackle one of the nine requirements for SG applications (energy efficiency and demand response), which is exactly the one used in the SH scenario.

Based on the development of SH applications, a new structure was designed that associates data technology solutions, innovative communication systems, and indoor identification with users and sensors to build a wide range of modern SH applications connected to the IoT. The working principle of an architecture present within the scenario of a smart home is demonstrated in Figure 1, in which it is illustrated the data transfer between local server to cloud server and the remote access using a mobile application.

With all devices connected to the internet as a result of the IoT, the user is allowed to connect to home appliances both internally via an intranet and externally via the internet, opening up a range of possibilities for intelligent services in the residential scope. The following requirements are needed to provide users to monitor, access and remotely control devices using the Internet [4], with an objective to achieve efficiency and viability.

Considering the above, this article has created a new Home Energy Management Systems (HEMS) architecture. This is known as smart management consumer architecture and has been based on the rules set out in [5] for interoperability and viability of SGs into the context of IoT in SHs technology.

The HEMS architecture is adjustable and includes important technological resources, such as remote-control capability, interoperability, reuse, modularity, flexibility, data security, and the possible use of computational decision-making techniques. Additionally, the scheme has as an objective to incorporate elements beyond the SH field such as SG. It creates a single integrated interface system with an interoperable layer, providing a web service with the tool by using an AMI applied in the cloud.

For example, in [6], [7], it is proposed solutions to identify only a single user’s consumption inside a residential home, while most of the residential homes have multiple inhabitants. The ZigBee protocol is also used in [6], [7] to control and gather information of house appliances, but distant appliances

may be out of range due to the short range of the ZigBee protocol, resulting in less reliable collection of data.

Therefore, this paper is an evolution of [6], [7], which now allows the identification and tracking of multiple users by internal Wi-Fi handover by making use of smartphones, and through the use of SO technology using NFC identification to extract accurate data from consumption, electric current, voltage and identification of electric household appliances. In this new architecture it is also used the LoRaWAN protocol, which is a long range and reliable protocol to control and gather data of household appliances.

This new proposal seeks to assist multiple users to achieve the ideal electrical energy consumption regardless of their location in the house and what appliance they are currently using, utilizing a recommender system to preserve electrical energy as well as user’s comfort.

## II. RELATED LITERATURE

Within the overall SH scenario, studies in the literature have recommended several kinds of HEMS to reduce energy consumption costs. This reduction can be achieved through a new exclusive feature for control and by monitoring or even making use of decision-making techniques solutions to assist in optimizing power consumption.

Several studies have been carried out that adopt a single approach to regulate an efficient measuring system required for residential homes. Some of those studies are similar to those discussed in this article, like [8] and [9] for example. Outlined in [10] is a HEMS that is capable of handling household appliances and lighting (through the use of consumption data collection). As examined in detail in [11] and [12], these HEMS models can be used for monitoring and informing users about the home energy usage rates through I) A mobile application, II) The WEB storage system and III) Sensors scattered around the houses.

Among the SH domain solutions already mentioned, some are based on computational intelligence. In order to automatically optimize the temperature and consequently save energy, fuzzy logic was used combined with thermal sensors to adjust the area temperature, and standards were established because of the guidelines recommended by the residents [13]. In [14], fuzzy logic is applied to decrease the energy requirements of a home with regard to several specifications, such as outside temperature, adjusted schedules, battery state-of-charge, and a wide range of prices and preferences for uses of electricity.

Fuzzy logic can also be used in a context-responsive scenario for recognition. Fuzzy logic in computational intelligence is capable of operating with an approximately 95% rate of accuracy and is slightly faster than other architectures, as explained in [15].

Looking to control and optimize energy consumption, other solutions of this kind are also used. A Bayesian Network (BN) is adapted and used to control power supplies designed for comfort in one of these solutions, as observed in [16]. This structure will probably form a link between the

condition of the equipment and the environment of residential homes.

An SG solution is established on cloud computing and Web Services is put forward in [17], using IoT sensors and devices with Artificial Intelligence (AI). In the study, a LoRaWAN connection is established to control some of the home appliances while sensors and actuators are used to measure environmental variables. The traffic data is collected and stored in the cloud server, by determining the interoperability measurement units and hence allowing the users access via notebook or smartphone.

In [18], an architecture is designed based on the concept of IoT to enhance remote access systems while simultaneously a) monitoring and managing a user's home and b) providing a more comfortable and secure system. The users will be granted access to the web or mobile applications that can make use of cloud services, including heuristic systems for SHs.

In [19], the author finds a solution for power consumption management and optimization to improve the security of the user's home based on IoT. This solution includes a relay module used to manage the device, security sensors for smoke detection, and a central device (in communication with the internet) and the communication between the user and the device takes place through the Internet and mobile applications for home management.

An intelligent home application based on the concept of the IoT is also developed in [19], although the application is deployed for remote access through the Internet or locally without the need for Internet access. This solution can be used for mobile devices that have access to a central host. This application can be used to manage numerous home appliances and control security.

A monitoring architecture was developed in [20] with the purpose of energy saving in the residential environment, using IoT and Machine Learning techniques. The physical part of the monitoring system makes use of a non-invasive current sensor connected to a Raspberry Pi 3 A+, which transmits information that is then stored in the Pi. The Pi transmits this data (date, time, globally active and reactive power, voltage, current, and active power readings from 3 different appliances) to the IoT middleware layer, where the data is processed and stored on a cloud server. Finally, the processed data is displayed in an application layer for better visualization. Mean squared error (MSE) and  $R^2$  tests were used, by which it was determined that the developed LSTM (Long Short-Term Memory) model had an accuracy of approximately 84%.

It is discussed in [21] the use and importance of IoT communication in buildings and in universities, working together with machine learning to conserve energy, monitoring through the use of temperature and  $CO_2$  sensors to determine how many users are present in order to manage the HVAC (heating, ventilation, and air conditioning). The communication between the sensors and the database will be done using both long range (LoRaWAN) and short-range

communications (ZigBee, Bluetooth, and RF communication) together with machine learning to try to predict, through probability calculations using Markovian queuing theory, how many people will be present, in which location and what would be the ideal temperature, having their data sent to a database for the interpretation and optimization of the HVAC to be made. It was concluded that among the tested IoT communications, LoRaWAN performed better with 60% more covered area compared to short range communications, also achieving 0% packet loss.

The aim of the paper in [22], is to evaluate the performance of LPWA (Low – Power Wide Area) technology based on a LoRaWAN solution for supporting SG applications, especially smart metering. It is based on a very simple wireless infrastructure and on a hierarchical structure that is suitable for many distributed measurements and IoT applications. Since the network is based on a star topology, it can make an interconnection between the end nodes and the base stations/gateways that collect and forward messages to and from the Internet toward one or more Network Server(s). The Application Server secures the user data sent to/received from the end device.

In [23], there is a discussion of an electrical outlet formed by the ATmega328 microcontroller and based on the ZigBee Protocol, which has devices to establish wireless communication between sensors, sockets, and the web server. In addition, it carries out the function of measuring voltage, together with current and power consumption, and making this information available to the consumer, who can monitor real-time power consumption through devices with a web browser and intervene by interrupting the electrical transmission to the plugs, if necessary.

A framework is established in [24], that is capable of determining single-user interactions in a multi-inhabitant SH through the use of multiple sensors installed in different parts of the house. This solution utilizes the Floyd-Warshall algorithm to calculate the distance between the sensors and the Sequential Importance Resampling (SIR) algorithm to determine the actual number of inhabitants and their initial location, based on the sensor's response.

A mechanism was developed to identify the location of users through infrared sensors in [25]. The project achieved good results but failed to achieve one of its main objectives; this was because it was impractical owing to the price and number of sensors that had to be distributed throughout the house, as they were unable to cover a large area.

Because of the cost and other problems arising from the excessive use of sensors, it was decided that the best solution was the use of intermediate communication and tracking through a smartphone, which is the most widely used device in the world and which most people carry around for almost twenty-four hours a day.

A Hierarchical Dynamic Bayesian Network (HDBN)-based model is used for activity recognition. This model employs inter-and-intra individual correlations and constraints, at both micro-activity and macro activity levels,

to recognize individual activities accurately. With the aid of mobile applications, this project allows the users to make use of their smartphones, along with the sensors, to determine which part of the house they are currently located in and whether they are together or not.

### III. BACKGROUND

#### A. COMPUTATIONAL DECISION-MAKING TECHNIQUES

Specific biological system models are referred to as the concept of Computational Intelligence (CI) and decision-making techniques, which has a type of efficiency technique in order to help users, allowing systems to perform smart decision-making actions. The type of insight instigated by computational decision-making represented has provided rise to the following standards:

An interoperable model (this presumes that operated intelligence such as neural networks arises from the dynamics of connections between nodes and layers known as artificial neurons).

Symbolic (consists of a set of rules and procedures and a set of symbols to form structures, such as decision trees).

Fuzzy (this allows the classification of a specific component associated with a particular class, that is, to assess in case of the aspect belongs to a class of greater or lesser significance, such as Fuzzy Logic).

Evolutionary computation (based on processes existing in nature essence, which can develop, and have adaptable management, self-organization, and genetic algorithms).

Because of these characteristics, they are validated for use in functions that include monitoring, automation, management, and actuation, which are the key features that are important for SG applications and SHs, a bigger importance is laid on decision-making systems based on fuzzy in this article. While also allowing fuzzy-based systems to provide as possible options to systems which have the resources explained in this article, some factors, such as agreeable computational effort, include solutions that establish good assistance for simplicity of rules and decision-making.

These fuzzy techniques can handle the complex variables by sorting out and/or forecasting the outcomes to help in the decision-making process, to notify residents about a possible increase in electricity consumption while also applying the optimal strategies for power consumption, based on the parameterizing which occurs when a smart consumption architecture is configured.

The fuzzy logic is one of the methods most often discussed in the professional literature while working with an automated system, and it also provides the means to communicate with the processes that are intrinsically similar to a computer [26]. It entails separating constant numeric inputs into various situations. These states, either distorted or overlapping, are defined through the use of Membership Functions (MF). The state of a variable does not change suddenly during the overlapping procedures, but it slowly loses its value in

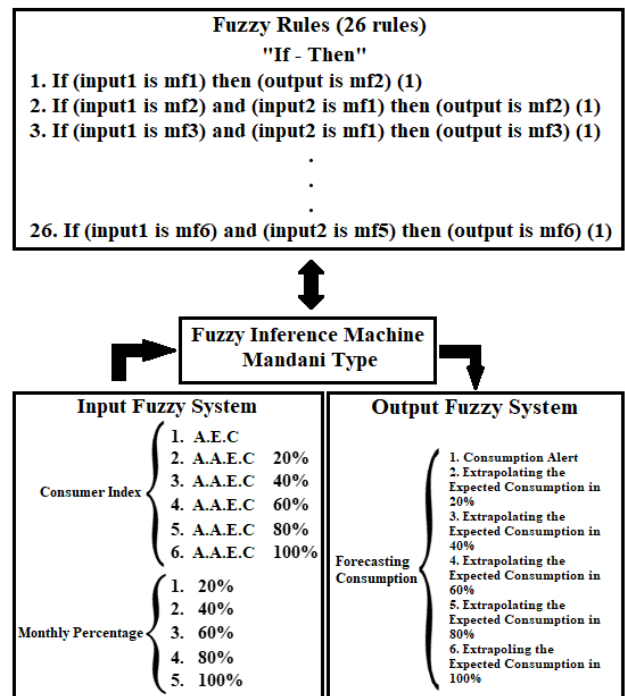

FIGURE 2. Fuzzy inference machine structure.

a membership function while restarting it in the following instead.

In [6], [7], the fuzzy inference machine was implemented for residential systems optics for energy management. This method obtained good results and, therefore, was used in this work to assist in the implementation of handover technology and smart metering.

As shown in Figure 2, the structure of the fuzzy inference machine has two input variables, which are the Consumer Index and the Monthly Percentage. These will be the input for the 26 fuzzy rules present in the inference machine that will be output after defuzzification, the Forecasting Consumption variable that will allow the inference of the user's consumption forecast.

The structure will then be able to use, in fuzzy logic, all the fuzzy sets of the response parameters. Such a conclusion is because of a set of Fuzzy rules that were previously defined and are viewed from the standpoint of a professional, as shown in the chart below.

For instance, Figure 2 shows how the input value for the Power Consumption Indicator can be converted into a derivative set with no values for Average Energy Consumption (A.E.C) and Above Average Energy Consumption (A.A.E.C), A.A.E.C having escalating levels such as 20% A.A.E.C, 40% A.A.E.C, 60% A.A.E.C, 80% A.A.E.C and 100% A.A.E.C. These will receive a grade of 1 for A.E.C and >1 if it is inside the A.A.E.C consumption range.

The framework is established by integrating all the values that are entered. The structure sets regulations within a specific situation. For instance, if the Power Consumption



Indicator has a combination of 1 "A.E.C." and "20% A.A.E.C." >1, all the rules, including "A.E.C." or "20% A.A.E.C.", will be checked. These rules will result in fuzzy output values that are then assembled in order to create a fuzzy set for each resulting variable, with the weighting factor normally varying between 0 indicating no result and 1 indicating the maximum result. Ultimately, the fuzzy set acquired is used to calculate the outcome of the output variable in the defuzzification phase.

When determining the optimization goal for energy consumption, the Indicator of Comfort (IC) is calculated from the results of the fuzzy logic.

When establishing the standard for the comfort zone with regard to household appliances and the level of human comfort, the formula for the Indicator of Comfort (IC) was expressed as follows:

$$IC = (EUH / NOH) * WD \quad (1)$$

where EUH is equipment usage hours, NOH is the number of hours while at home and WD is the number of days in a week.

Hereafter, the implementation assumes one of the following approaches:

- (a) Balancing supply and demand in Reducing the excess of Energy Consumption (Profile 1): Excessive consumption is offset by the amount available for other appliances based on the value of the total consumption of each appliance. This new rate of consumption amount is calculated employing the following formula:

$$ECP = (KEC * 100) / HEC \quad (2)$$

$$CRP = (EC * ECP) / 100 \quad (3)$$

$$NEC = (KEC - CRP) \quad (4)$$

where in Formula 2, the ECP (Equipment Consumption Percentage) is the percentage of consumption equipment that is given with regard to a) potential energy; b) KEC (KWh Equipment Consumption), the consumption of the given equipment in KWh; c) HEC (House Equipment Consumption), the value in KWh of the total energy consumption of the residence.

In Formula 3, the CRP (Consumption Reduce Percentage) represents the percentage by which a given appliance will reduce its exceeded consumption; EC (Equipment Consumption), consumption exceeded from the average consumption.

And finally, in Formula 4, NEC (New Equipment Consumption) will be the new consumption assigned to each appliance, in order to reestablish the energy balance.

- (b) Reducing the excess of electricity consumption based on a Priority Sequence (Profile 2): An energy consumption limit set for the most widely used appliances is going to be kept and the excessive consumption is reduced from the least often used appliances to maintain the estimated consumption limit.

- (c) Energy management on demand (Profile 3): The user will have complete autonomy to choose which appliance should have its consumption reduced to maintain the estimated consumption limit.

It is possible to assist the end consumer if they exceed their daily average rate of energy consumption while looking for a way to preserve user service and all the essential amenities in order to guarantee a lower impact from the usage of appliances. With that in mind, the plans explained above take into consideration the extent to which the comfort that each piece of equipment in a household offers to each user. This paper will use the first approach as a reference point.

## B. HANDOVER

Apart from identifying the total energy consumption in an SH, one of the main objectives of this architecture is also to share this information with all the users through the use of a mobile application, by giving them an individual electricity consumption limit for each appliance which could be shared if two or more people are in the same room.

It was decided that the best solution was the use of intermediate communication and tracking through a smartphone, which is the most widely used device in the world and which most people carry around for almost twenty-four hours a day. With this idea in mind, a system was devised that resembles handover.

Essentially, handover is a process of exchanging access points (AP) based on signal quality identification. For example, if there are two APs, and the signal a smartphone is currently connected to is weak, the handover tends to switch from that AP to the one with the best signal. Handover is essential not only for comfort but also for applications that use real-time data exchange, for example, phone calls like these require a quick data exchange, and when on the move, a manual exchange is impracticable.

The handover technology is of great importance to this project, as it enables multiple users to be identified in real time, together with a description of where this person is, what appliance is currently in use, and how much energy that person is consuming, regardless of the location.

A micro network can be created at the user's home that consists of Arduino microcontrollers, together with the ESP 8266 that will simulate an access point (AP). This microcontroller will be used to identify particular rooms in the house by Received Signal Strength Indication (RSSI) and determine how many users are in those rooms and who exactly they are. This search will be carried out by mapping the signal strength, and this signal will be restricted to the area of each room through a microcontroller that will be positioned in the center of the room.

This mapping will be done in each room at a time, with the help of a small tutorial that will require the user to stand:

- Under the microcontroller.
- In the corners of each room.
- Between the microcontroller and the exit door of the room.

(d) And finally, by the exit doors, in order to provide each room dBm limits to the HEMS.

The information will be sent to a database along with the identification of the user, by using the MAC address of the smartphone, together with the information about each part of the residence, such as the bedrooms and suite bathrooms, so that consumption can be shared more easily.

The way the handover process works in this project is as follows:

- (a) In each room of the house at a central point (or close to it), there will be a microcontroller that will be an AP.
- (b) Each environment that has an AP based on the microcontroller, will be mapped by the dBm (RSSI) levels present at its ends through the software developed for android devices. This mapping will be done by the user, simply and intuitively.
- (c) The smartphone that belongs to a given user, present in a given environment, will send a Wi-Fi scan that will enable to connect to the nearest and with the strongest microcontroller AP signal, which in this case, will be the one located in the environment in which the mobile device is found. Thus, if a mobile device is connected to an AP and it is within the dBm limits pre-established for that environment, the HEMS system will indicate that the user is located in that specific environment.
- (d) When the user moves to another room, the dBm signal from the AP of the previous room that the User was connected to tends to weaken. With this, the software will make the analysis identifying that the user is outside the pre-established RSSI limits for that particular environment, thus causing his disconnection from the old AP, and the realization of a new Wi-Fi scan in search of an AP with the stronger signal, consequently implying handover between APs. Therefore, the system will identify the user's new location.

The natural barriers of a building, such as a masonry, plasterboard, and others, which promote the division of rooms in a residence, end up helping in the indoor positioning of the User through RSSI and in the handover of AP, since the intensity of the Wi-Fi signal within an analyzed environment it is much stronger than when analyzing the same when leaving the environment. This phenomenon is depicted in Figure 3 occurs due to the attenuation of the Wi-Fi signal promoted by these natural barriers of the building, which cause a decrease of around 10 dBm.

Thus, the moment the user leaves the environment in which he is connected to the AP, the attenuation of the signal makes the HEMS system clearly realize that due to its low connection intensity with that particular AP, the user is no longer inside the room.

Therefore, this implementation denotes have a differential compared to other projects using sensors [24], [25], [27], [28], or even using only the MAC Address, when analyzed in the user identification part with little change in the environment, since having a homogeneous distribution of the Wi-Fi signal in homes is already desired today, as well as the number

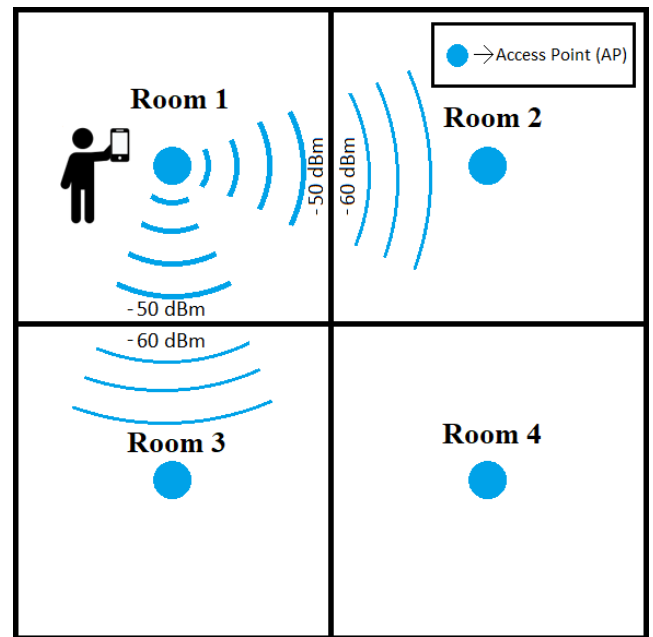

**FIGURE 3.** RSSI signal attenuation exemplification due to the natural barriers of a building.

of antennas (AP) throughout the residence, has also grown. Therefore, facilitating the inclusion of APs based on microcontrollers, such as network expanders and user identifiers.

### C. INTERNET OF THINGS

Internet of Things is a network of appliances and devices, which detect and share information about the physical world in real time, they can be objects, buildings, machines, vehicles, and other physical systems with built-in computing, communication, and sensory resources [29].

In order to give the end users access to all devices connected at home, IoT solutions are used for home control, which includes communication and information technologies and may also involve the remote control of appliances in real time, as well as information sharing.

Since it is divided into layers that represent the operation and management architecture, the IoT can connect elements from the real world and include others in the communication system that can intelligently process its detailed information and autonomous decisions [30]. These layers can be described as collectors, actuators, and sensors in the lower layer, supported by the network layer, which has an essential role for transmission and security of the data provided to the upper layer, that are responsible for creating smart strategies linked to rules and business applications. The Middleware Layer has been designed to provide management services to the lower layers and data storage.

In addition, there are great volumes of data that could be collected from various segments such as SOs and handover, which will provide consumption data and user location. It is necessary to combine the IoT with cloud services in order to be able to analyze and process data, providing useful information for the final users.

A widely used technology in the IoT scenario is the cloud computing service, which, in addition to providing shared storage, resources, information, and software, provides remote access for all the appliances connected in the network [31].

The main goal of this paper is to develop an architecture that can assist the user in making decisions about their consumption through a mobile application in which, together with IoT technology, the appliances that are consuming electricity and how much is being consumed can be identified through the implementation of SOs.

It is also possible to identify multiple users by implementing a system with handover characteristics. Having these data stored in the cloud, the user can have this information available on the web and also through the application itself, being able to observe in real time his/her energy consumption and rebalance it when necessary.

To make sure that the system can work properly and that any user, with or without prior knowledge, can understand how to use it, it is necessary to:

- (a) Download and register the user account in the mobile application.
- (b) Map the limits of each room in the house based on physical limits such as walls and doors, so that the energy study and indoor location can be done.
- (c) Define their monthly electricity consumption limit, in order to establish the maximum consumption that the house can have.

If this limit is exceeded, the user will be notified by the mobile application through a pop-up notification and will be offered to choose one of the three profiles previously mentioned to rebalance their energy consumption.

#### IV. THE PLANNED ARCHITECTURE

This architecture sets out an innovative model based on IoT services of interoperability for SHs. This can be achieved by defining a middleware procedure based on REST API (Representational State Transfer), which integrates company monitoring systems with the measurement techniques available to the consumers.

The architecture also allows the control of alternative sources of energy (distributed generation) and the automation of home appliances through smart devices and controlling the rate of message consumption, for example by setting out rules for scheduling daily activities, as well as the administration of the real time energy consumption of household appliances.

The goal of the architecture is to maintain the underlying principles for the development of SH interoperability applications in a dependable, sectional, adaptable, scalable, and accessible way since these are solutions that are widely used in SH domains. It also lays down the requirements for providing cloud management services and is carried out generically to ensure other effective solutions could be found in the future. The planned architecture characteristics are:

- (a) Dependable: This architecture integrates a method for both the verification and safety of data at the application layer of the network.

- (b) Sectional: As this is an open architecture, the functionalities discussed in this project are not applicable. If the communication protocol is maintained, it will be possible to extend other management modules (for example, lighting management).
- (c) Adaptable: Implementations can be made in specifications other than those listed in this project (paper). It should be noted though, that the solutions described in this paper are mostly those discussed in the published literature.
- (d) Scalable: This allows new modules to be included, while also extending the network management.
- (e) Accessible: Providing that there are prior permission and Internet access, there is no restriction of access that prevents users from controlling their monitored appliances, regardless of their location.

In addition to tackling the problem of how consumers should be responsible for home management, this architecture also designs middleware that is loosely associated with publishing/subscription capabilities (IoT services). This serves utility purposes and allows communication between systems through an exchange of messages, as well as resulting in different solutions that can assist interoperability at various categories of the middleware client. This means that the system can improve scalability without being restricted to a specific solution.

The architecture set out in this paper permits the use of heuristics based on computational decision-making techniques together with the adoption of smart management services. As a result, the evaluation of the variables obtained from the instrumentation and extraction standards can assist in characterizing the consumption of each consumer, and eventually be applied to the optimized model designed for efficient measurement. Therefore, this architecture is not restricted to extract and study basic patterns of energy consumption for each monitored user but also be extended to acting as a communication channel between varied elements of data traffic.

Figure 4 represents the structured model that supports the architecture set out in this paper. Each layer represents a specific role that includes the operational features of the architecture which can be adjusted to improve adaptability and scalability. Also, Figure 4 illustrates many of the essential components that are required for the implementation and interoperability of the proposed architecture.

The measurement node proposed, as a new version of the old one present in [7], has the function of checking the data of electronic equipment through voltage and current sensors to obtain consumption data, as well as extracting other data such for example, in the precise identification of which electronic equipment is actually connected to that outlet using NFC technology.

Each SO, as well as each connector of electronic equipment, will have an NFC microchip. On the electronics side, through the software developed for android, the user will be

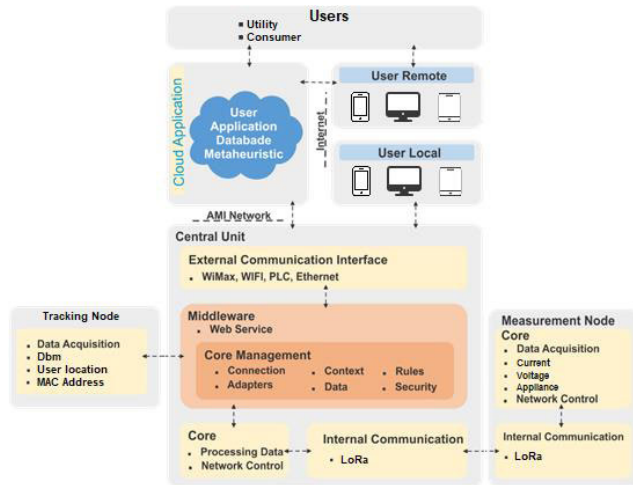

FIGURE 4. Proposed architecture components diagram.

able to insert the electronics data as brand and model in the present NFC tag.

On the NFC side present in the SO, it will receive the precise data (brand and model) of each device that will be connected to it and, together with the voltage and current data, they will be transferred via LoRaWAN protocol, which is also another evolution of the SmartCom [7], for the central unit.

Another evolution present in the work was the tracking node that also communicates with the central unit, which will have the main function of identifying as well as locating the user within his/her residence, by indoor handover methods that will take into account the signal strength RSSI in relation to the APs.

The interoperability of all the components in this architecture, whether consisting of hardware or software, is of great importance to ensure they are following accessible requirements that might need to be adjusted to the exact features of a particular scenario or external and internal communication interfaces as well as this, the communication protocols must be compatible with the REST API. It is owing to the interoperability of the hardware and software components, as well as the adoption of open standards, that these can be customized to suit the needs of the user or manufacturer.

#### A. MEASUREMENT AND TRACKING NODES AND CENTRAL UNIT LAYERS

Elements with communication interfaces are provided for the central unit, measurement, and tracking nodes to operate the communication functions specified in the architecture. An attempt is made to maintain the integrity of the system by creating a transmission channel for the features of measurement, to prevent any loss of data. LoRaWAN is a wireless network protocol (IEEE 802.11ah) for low frequency networks and sensors and is generally utilized to create a network platform for home security, industrial, and IoT applications. Moreover, if there is a bottleneck in the network, this protocol will be used as internal communication.

There is a separation between networks where:

- For end users, there is an alignment with open standards (such as Ethernet and Wi-Fi) already recommended by the SG through which they can make use of to request utility services.
- For the power companies, a network that efficiently manages the requested service by adhering to a closed standard is used, that is less likely to be vulnerable, such as PLC or 4G.

The external communication interface helps users to handle the data and the external environment in the central unit.

To ensure the network access technologies are transparent they need to be subjected to inspection applications. The key feature when providing access to data in heterogeneous domains is communication, which entails establishing real-time access for users no matter where they are and a determining factor in making this architecture work.

This is defined as the “main administration” or “aspects of administration”. These include data, adapters, connections, contexts, security and rules, all of which require the use of the architecture to function properly.

Several connections of the measurement nodes and the tracking nodes are installed on the consumer side, and the connection administration is used to manage the communication between the central unit and these nodes. This involves the inclusion of adapter management, which permits communication between the middleware types, as the communication interfaces must be installed via Web Service. In addition, since connection management is a means of restricting traffic, supervisory messages can be prioritized as needed, given an urgent request from the utility’s monitoring system.

For managing environment variables in the architecture and communication ports, the responsibility is at the context management, including message priority classes for control, encryption rules, and so forth. However, an identification of each device monitored by a measurement node is needed for a more effective and transparent means of control.

Each device in the architecture requires an identification protocol and its category (if necessary) so that it can be activated by the surveillance system. Defining rules and strategies for optimizing the consumers’ energy when developing the identification field is severely important and provides a clear view of consumption patterns.

Fuzzy logic is a decision-making technique required in this paper to be an accountable implementation for developing optimization rules that can be applied to smart appliances or extracting consumption patterns.

As real-time location systems (RTLS) provide information that is private to the resident, not only because of the location but also because of the MAC that is required for user verification, this information will not be sent to a possible communication center with the energy retainer. However, the function of the REST API will be to make the databases “talk to each other” so that the fuzzy logic can work correctly and obtain the information from the measurement and tracking node. This will result in consumption profiles that have better



control of the stipulated limit defined by the end user, (which will be discussed later).

The data management enables the measurement and tracking devices to be handled and stored, together with the environment variables and data, (whether they are local or remote), and these are obtained from remote databases in the cloud. In the future, store rules will be enforced that are based on metaheuristics (i.e., the management rules). Both supervisors and consumers must be present in this layer.

The security administration system will be responsible for creating security standards for transactions, certification, access, adversity in recovery, and encryption, which can be applied to services implemented on the platform from an application perspective. Since this design provides the use of web services established on REST API, the secure utilization of frameworks is highly recommended, such as the OAuth2 framework, to ensure that the information and access provided are safe and reliable. Also, issues such as communication networks between supplier companies and end users or external issues are not addressed to this layer. However, this research study assumes that the network and the utility have met the security requirements. The specialist literature has revealed numerous ways to implement communication networks for this purpose, as described in [5], for example.

The middleware layer can be used to switch to renewable energy sources for energy regulation or send control messages such as how to turn the appliances off remotely and offer a view of all the components. It is also used to show how each user's internal and external environment can be used to store variables. Additionally, it is in charge of creating interaction with cloud and web services.

As it uses its tools without interfaces to be integrated with other new applications more easily, it is a separate module and is under the supervision of the utility. Nevertheless, customers and supervisors can rely on REST API to perform management tasks at this layer.

The measurement node designates the main layer that is needed to capture all the measurement readings and acquire data from monitored devices. As well as this, it is responsible for handling actuation and control messages, as well as collating the data sent to and from the network.

### B. LOCAL AND CLOUD APPLICATIONS LAYERS

A mechanism is provided by the local and web application layers to check and control components belonging to the architecture. These applications must work successfully regardless of the platform and be compatible with the REST API services.

The cloud layer provides a method of displaying information in any device in communication with the Internet, and thus centralizes services which are essential for remote access and monitoring the connected elements. This layer is responsible for the data transferred by the central unit storing all the data of the tracking and measurement nodes and which database service will manage these data. It also provides a

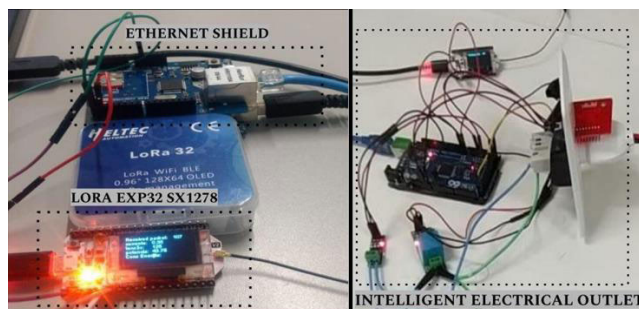

FIGURE 5. Measurement node prototype.

management application for monitored appliances and acts as an intermediary for remote management requests.

This layer also provides an efficient method of classification based on energy consumption and management, analysis, and optimization rules that can be established for the instrumentation of each user. That is done by specifying metaheuristic services (through computational decision-making techniques).

Local and remote applications can use REST API requests to manage monitored devices and establish full control of the available services that are based on access profiles.

## V. IMPLEMENTATION

Measurement and tracking hardware are created for the validation of the architecture, as well as its software that will enable, automate, and control the residence.

### A. HARDWARE

Based on the features discussed earlier, the central node components must be adept to manage and monitor the measurement nodes and also provide the installation of the applications or other functions (both the middleware and additional software created with the objective to store the data), while at the same time meet the demand of the customer.

After collecting data from the sensors, the measurement node then transmits it via LoRaWAN to the central node. It not only collects information but also disrupts household appliances (power on / off). In this scenario, each outlet will be fitted with a measurement node that can read each device connected to the electrical network for better measurement efficiency.

As well as storing information such as current, voltage, user's electrical energy consumption, data, and usage time, the central node also performs a crucial role in monitoring and controlling any connected electrical devices. All the information is encapsulated and sent via LoRaWAN communication and forwarded to a central unit.

The measurement node that is recommended identifies the type of appliance connected to it, through the NFC tag on the device plug is depicted in Figure 5. The tag is read by the NFC reader that can be found in the SO, and the information

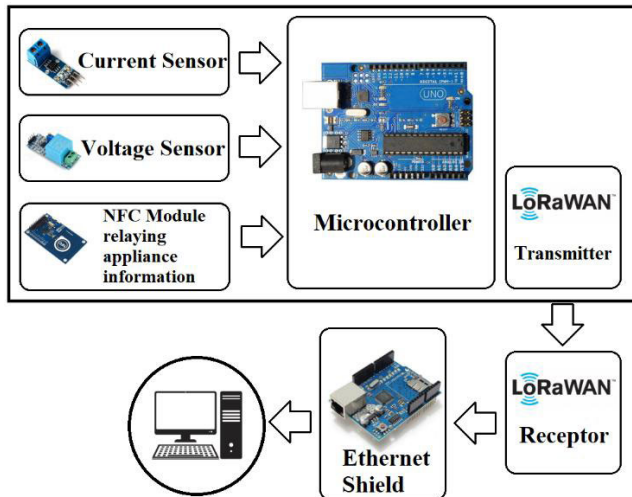

FIGURE 6. Communication scheme of the smart outlet.

about the type of electrical equipment is conveyed to the ATmega328 microcontroller.

The registration of NFC tags is done through the application, having the ID and information of the appliances saved in the database, so that when the SO is used, it is identified which appliances are consuming electricity. This also receives the voltage and current data collected by the sensors and processes this data based on a timeframe to calculate energy consumption. Figure 6 shows the communication scheme of the measurement node.

In the case of real-time tracking, the process of sending information is similar to that of the measurement node and this technology sends information to the middleware. The nature of the information comprises where the user is and the dBm (signal strength) of where she/he is located.

As illustrated in Figure 7, the physical structure of the handover consists of an ESP8266 and an Arduino microcontroller, which will be positioned in the center of each room in the house in order to distribute the signal evenly to all ends. As mentioned earlier in section 3, this hardware will aim to promote the acquisition of the RSSI signal in decibels, as well as being also responsible for the user’s interconnection to the internet as a common Access Point. The user will leave a fingerprint, which is essential to accurately indicate the location where the user is, thus capturing the signal strength information according to the distance.

**B. SOFTWARE**

As a means of finding an SH solution for energy management, this paper seeks to enable interoperability to occur between customer metering, real time tracking, and other management applications. Hence, a system must be implemented with a layer based on the REST API that accepts interoperability between these features. Overall, these applications should be compatible with the Web Service technology chosen for this architecture.

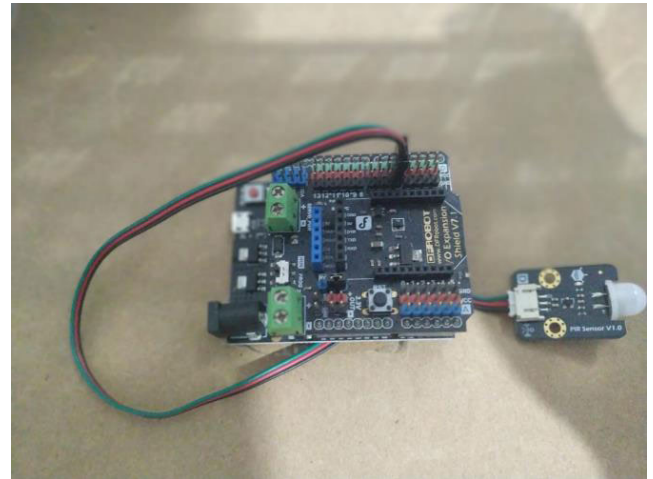

FIGURE 7. Prototype of a tracking node.

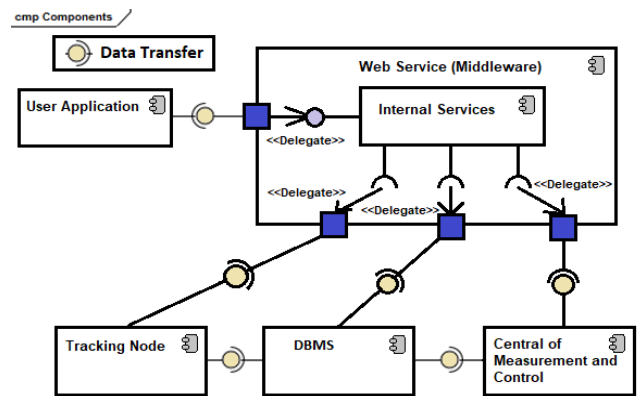

FIGURE 8. Diagram depicting the web service layer (middleware) components.

In Figure 8, the interoperability between the measurement and tracking node is demonstrated. This interoperability will be done through the database and the middleware in which the database will send the information received by the nodes so that the middleware can then process it and send it to the application and web service.

This system includes features of the above-mentioned technologies, like the SO and handover, and uses REST as middleware.

Together with residential metering equipment, the interface of this middleware can connect applications for final users and utilities. Furthermore, highlighting numerous control and management actions is made possible by using these middleware features, such as, the necessity to access the measurement information recorded in a database by the central node and set parameters for the transmission of this information to the management structure of the power utilities.

Nevertheless, depending on the type of user, some functions will be restricted to ensure the safety of the residents, the utilities are not permitted to turn off any electrical device which is controlled by the system, for example. This is exclusively for the use of the residents, and users of the MAC Address. Moreover, their location in the house is only visible

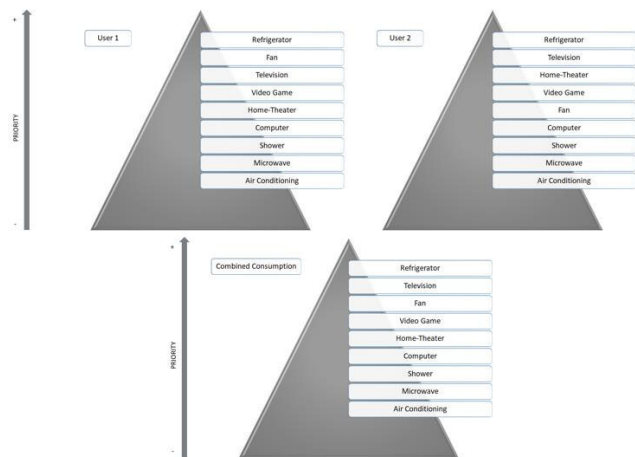

FIGURE 9. An overall pyramid scheme for users.

to the residents. Instead, the energy supply of the utility can be interrupted manually.

A procedure has been developed that is based on the fuzzy logic system regarding applying a meta-heuristic for validation. The system may notify the customer of the necessity to lower the energy consumption based on the input variables (consumption indicator and rates) after which, the information handling will be conducted in order to guarantee power savings.

This implementation is necessary before the consumption plan of each user can be defined since it relies on the information collected from the measurement node and the tracking node. Besides, the fuzzy logic must calculate the consumption and produce results that can help each user, regardless of the device and where he/she is located in the residence.

The individual rate of consumption will be measured for each individual. In Figure 9, the pyramids are formed utilizing fuzzy logic and represent the most and least used appliance of each user, the most often used being on the top and the least used on the bottom.

The user pyramid schemes will serve as the basis for optimizing the consumption defined in the profiles, as the question of if each appliance can have its consumption reduced or not, depends on whether it is at the top or the bottom of this pyramid. This optimization will be discussed later.

User pyramids will result in an overall pyramid represented in Figure 9 as “Combined Consumption” that also lists all the appliances used in the house and provides information about which consume the most or least amount of energy. This information from the overall pyramid will be made available to the energy utilities, as it has information on the general consumption of the house.

The pyramid data is extremely important to be able to rebalance the user’s consumption when it is necessary to use the profiles because a poor definition of the priority of the appliances can directly impact the user’s comfort by rebalancing inefficiently.

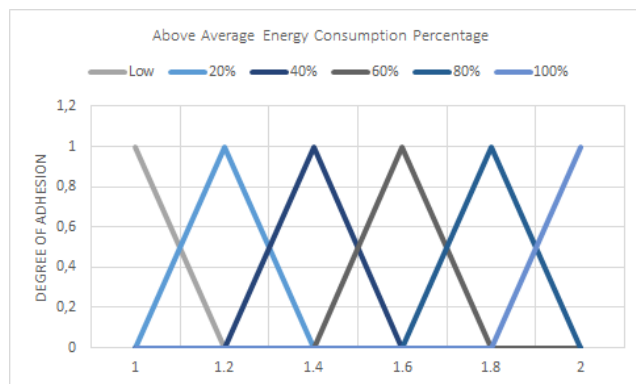

FIGURE 10. Above – Average Energy Consumption Indicator in Fuzzy Logic.

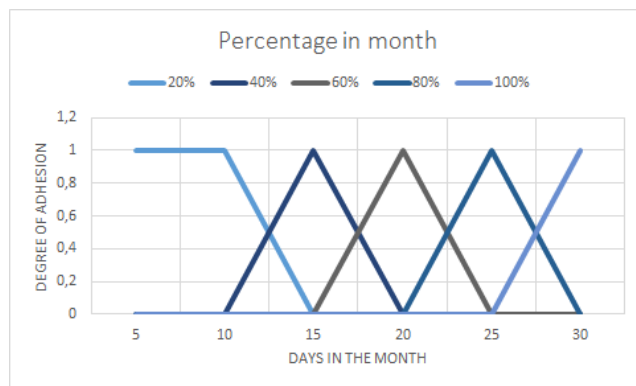

FIGURE 11. Monthly percentage input from a Fuzzy Logic perspective.

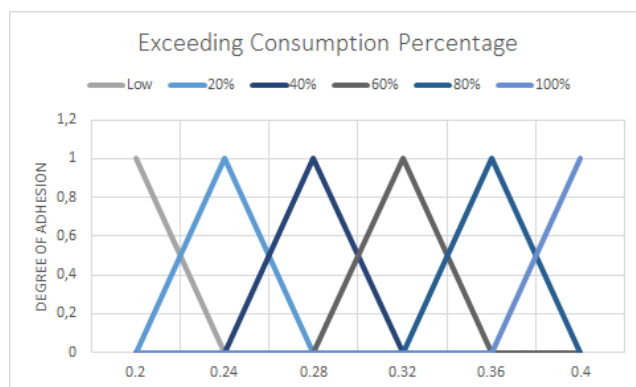

FIGURE 12. Exceeding consumption percentage.

The pyramids of the users will result in a general pyramid that defines the most widely used appliances in the house. The information about the general customer that will be made available to the energy utilities, will be taken from this pyramid, which is shown as a residence.

It is also made clear that when two or more people share an appliance in the same room, the consumption will be divided between them for better comfort, distribution, and consumption optimization.

The Power Consumption Indicator (PCI) is calculated based on the information provided by the automated housing system. This information includes: Use up to the current day

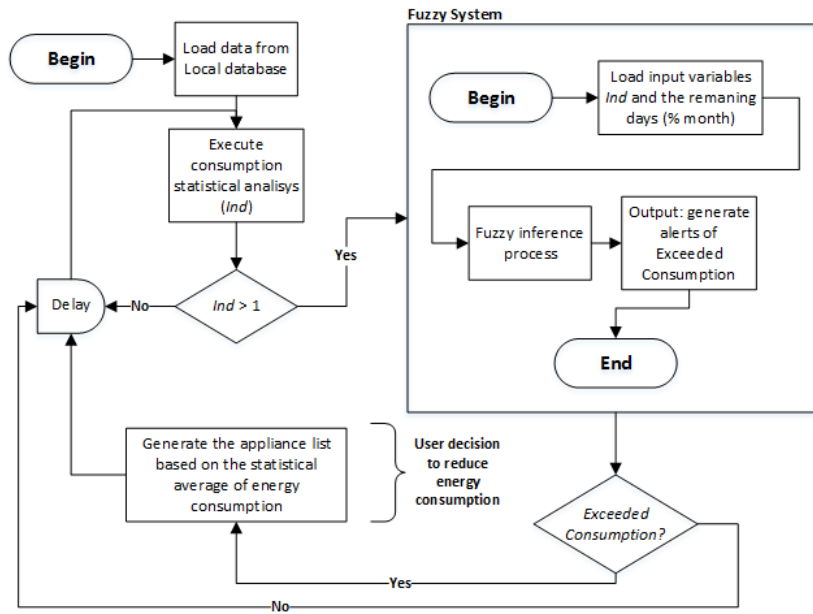

FIGURE 13. Decision-making system flowchart [7].

(CC), current day of the month (MD), historical consumption average (HCA), and the number of days in the current month (CMD). Based on this data, the indicator will be calculated by (5):

$$PCI = CC / (MD (HCA / CMD)) \quad (5)$$

From the “Indicator of Comfort” formula (specified in the background section of this paper), it is possible to acquire the values for PCI. They are divided by scales, where  $PCI = 1$  suggests that the consumption is inside the typical range. It is shown in Figure 10 that when  $PCI > 1$ , it is separated into scales ranging from 20% to 100%.

Similarly, in Figure 11, the input variable “Monthly Percentage” is divided into 5 pre-established periods.

The output variable “Excess consumption” may undertake six potential states from the starting point of the graph after the Fuzzy machine has been completed, meaning that the consumption falls inside the average array. If this is within a range from 20% to 100%, it indicates that the amount consumed has been surpassed, as it is shown in Figure 12.

Additionally, when the Fuzzy inference system sends the final result, the occupant will then be instructed by a notification on her/his mobile application. The alert will show all the devices that have exceeded the expected consumption rate and the user can follow steps to provide an optimized usage plan.

This system output completely depends on the “Index” and “% per month” input variables. The output is also changed when the input values change.

The configuration management system can make decisions with greater precision based on data, to ensure that the users can be informed of the current rate of electricity usage by checking the consumption of electronic devices.

Also, based on the excessive consumption shown by the unclear system, the factors which result in increased energy usage may be included from the information observed for every device. This means that the users can decide based on the defined strategies of the profile, which elements to disable, or how to reduce their use. Figure 13 illustrates a flowchart used for explaining the stages of the decision-making system.

## VI. DEMONSTRATION AND RESULTS

The operating process of the new architecture is demonstrated in the flowchart format in Figure 14, being possible to verify the necessary steps for the correct functioning of the system through the APs, handover system and SO, to provide smart energy management for the user.

The interoperability between the handover and the SO will identify which room the user is in and what is being consumed by him/her, determining the identification and the precise location so that their consumption is optimized in the best way.

In Figure 15, the system illustrates the user identification process and data acquisition from the system SO. This data will be acquired and sent to a server to be processed and later sent to the middleware, showing the information already processed in the application and the Web Service.

Additionally, with the interoperability information, two systems have been designed for the architecture in different domains, one being a system for mobile devices while the other is a system for WEB applications. The objective of both systems was to show the viability and justification of the planned architecture.

The two designed system prototypes require monitoring and administration utility that are consistent with the



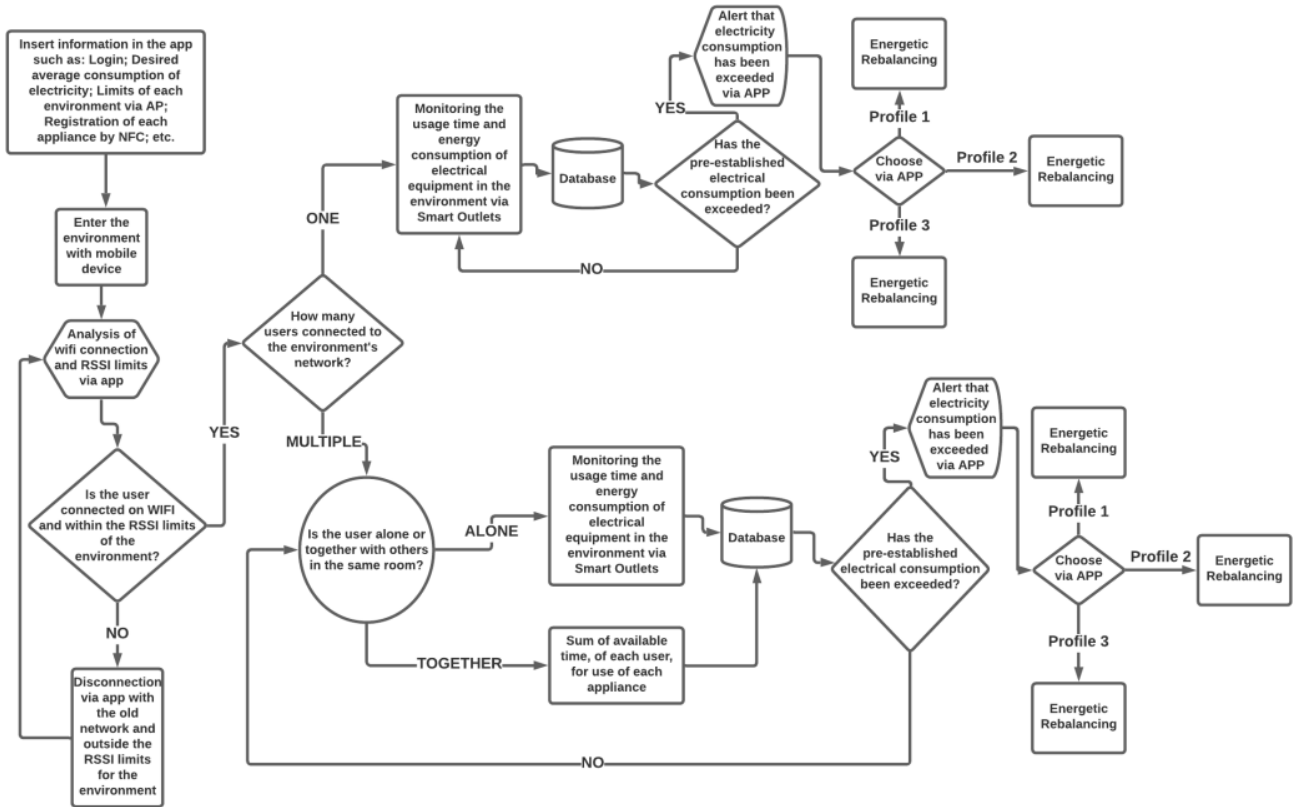

FIGURE 14. Diagram of the proposed new architecture.

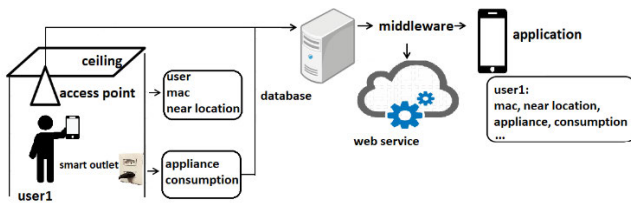

FIGURE 15. Tracking node and measurement node interoperability.

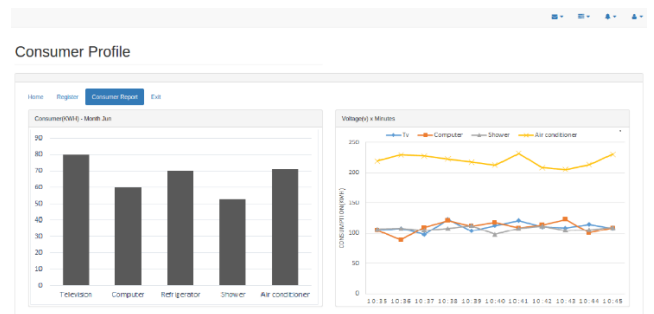

FIGURE 16. The monitoring system – WEB case study.

ones of the proposed architecture. These are not limited to the users’ access platform or the established types and the access limitations are established in the validation scheme. Figure 16 shows consumption in real time, giving the user the possibility to view the energy consumption of each device in their environment via the web interface.

Figure 17 displays the two screens of the mobile service, which include the initial screen and the ‘main menu’ screen with the ‘general options’.

The first screen requires user registration or log in to access the application and web services. The user registration will not only serve to register the user in the system but also in case there is a problem that causes the user to change smartphone (for example technical problems or the loss of the device).

Therefore, the user can log in with his registered account normally on another smartphone and can continue using it.

The second screen contains the application’s general options as well as some information about the user’s current location, current dBm, and MAC Address. This information is provided by the user tracking system. The mapping will be done to establish the signal strength inside each room and the software will determine the room the user is currently in, based on the signal identification and taking into account the limitations of each room defined by the mapping done previously.

The section for registering an NFC tag information is available within the user and room settings menu, and the information will be sent to the cloud database after registration.

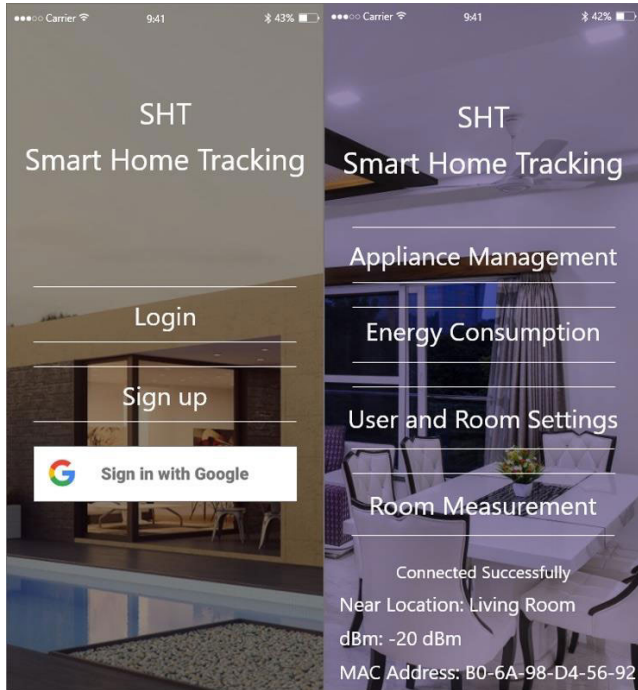

FIGURE 17. Mobile application login screen and menu screen.

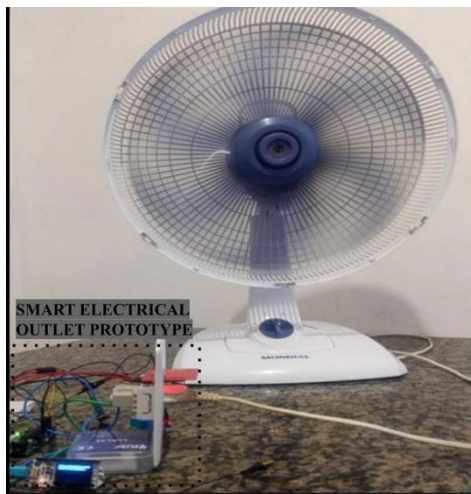

FIGURE 18. Smart outlet test using a fan.

Other results can be obtained by manipulating the collected set, in addition, to be able to view the information through the designed solutions, starting with the data locally stored (but only the month of measurement in the central unit) or data stored externally.

Tests were carried out to check the accuracy of the measurement node. As illustrated in Figure 18, a fan is connected to the SO.

As shown in Figures 19 and 20, it is possible to verify the voltage and current values information taken from the database in real time, as well as the appliance that is currently being used. In Figure 19, the current graph is represented by a continuous line because in the scale presented, its variation is always within the 0.6 ampere range, thus the current oscil-

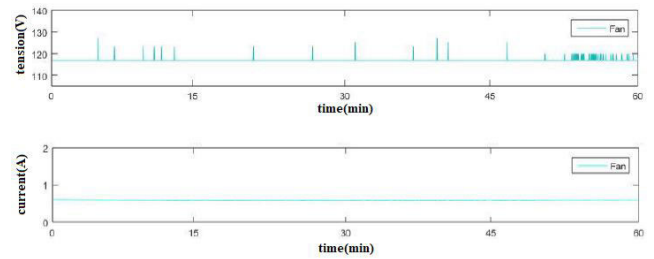

FIGURE 19. Fan voltage and current obtained through the smart outlet.

id	appliance	current	voltage	potency	date
1	fan	0.641	117.1	75.121	2020-11-01 20:01:16
1	fan	0.638	119.1	76.101	2020-11-01 13:23:04
1	fan	0.641	117.1	75.129	2020-11-01 08:20:36
1	fan	0.621	123.4	76.701	2020-11-01 06:12:04
1	fan	0.635	118.1	75.111	2020-11-01 01:54:00
1	fan	0.639	117.4	75.038	2020-10-31 16:36:41
1	fan	0.601	128.4	77.002	2020-10-31 14:11:49
1	fan	0.631	120.8	76.272	2020-10-31 06:25:36
1	fan	0.637	118.1	75.322	2020-10-31 04:45:42
1	fan	0.626	122.2	76.501	2020-10-31 03:29:06

FIGURE 20. Database containing the information obtained from tests using the fan.

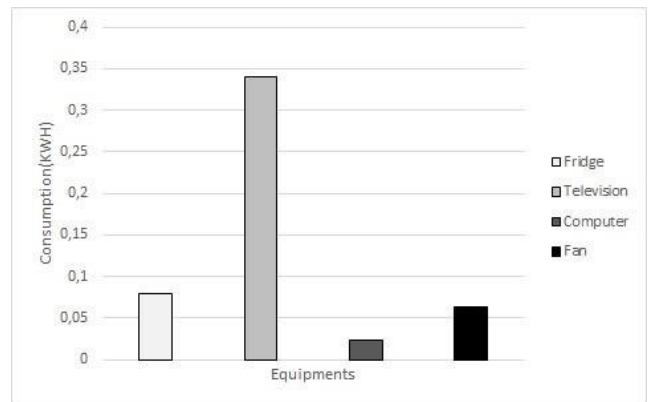

FIGURE 21. Graph to visualize Consumption (kWh).

lation is imperceptible in the graph. The data in Figure 19 are shown in Figure 20, which are stored in a database with the time, date, and power recorded from the fan test.

Figure 21 shows the consumption data of the appliances, which are extracted from the measurement node, using the NFC to identify which appliance was used and its consumption extracted by the electric current and voltage sensors.

In order to represent the potential for energy consumption optimization, surveys and measurements have been conducted to test the SG, involving the collection of entered data necessary for the authentication of the results.

Based on the information gathered and displayed in Figure 22, a smart approach has been employed to assess the possible results for energy use optimization.

After profile 1 was successfully applied, it is noticeable a decrease in the energy consumption of each appliance in proportion to its overall consumption, until the excessive amount

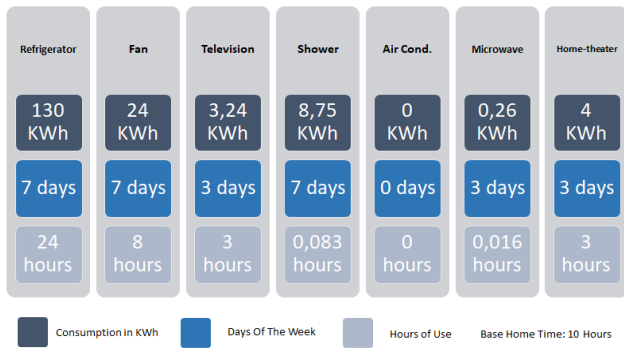

FIGURE 22. Users energy consumption average rate.

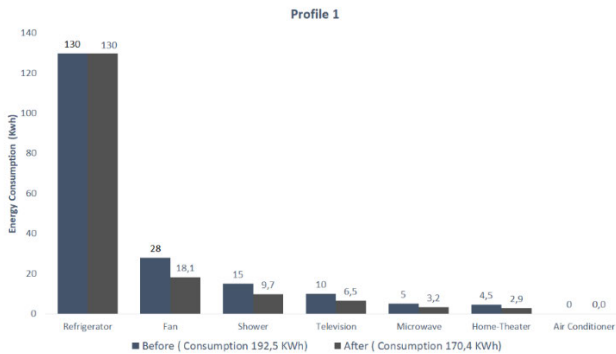

FIGURE 23. The balance of appliances energy usage based on overall consumption.

of power consumption was reduced based on a 171 KWh limit.

In Figure 23 this can be observed in the fan for example, which had its limit reduced from 28 KWh to 18,1 KWh. Previously, the shower’s consumption amount limit was 15 KWh but following the implementation of regulatory measures for consumption, this amount has been reduced to 9.7 KWh, and the rates of every other appliance have also been reduced.

Even though the consumption of the refrigerator is being shown in the image, it will not get reduced as it is essential for the user in their daily lives. Therefore, it is necessary to continue its constant use since the user keeps this equipment on every day of the week. As a result, its operation regime is not analyzed, that is, the next day it will continue with the same consumption even if there is excessive use of electricity and the user utilizes the profile to perform the energy rebalancing. The refrigerator, being the most essential appliance for the user, in this case, will continue with its regular consumption regardless of the scenario.

This is the objective of Profile 1, which makes a proportional reduction of each one and manages to balance the consumption rates of all the appliances to ensure the end user is provided with a suitable degree of comfort.

The system’s main goal is to establish the viability of the designed architecture, as well as encourage its endorsement. Figure 24 illustrates the monthly consumption, based on the data collected through the use of SOs, as well as the results for the estimated energy consumption after Profile 1 was applied.

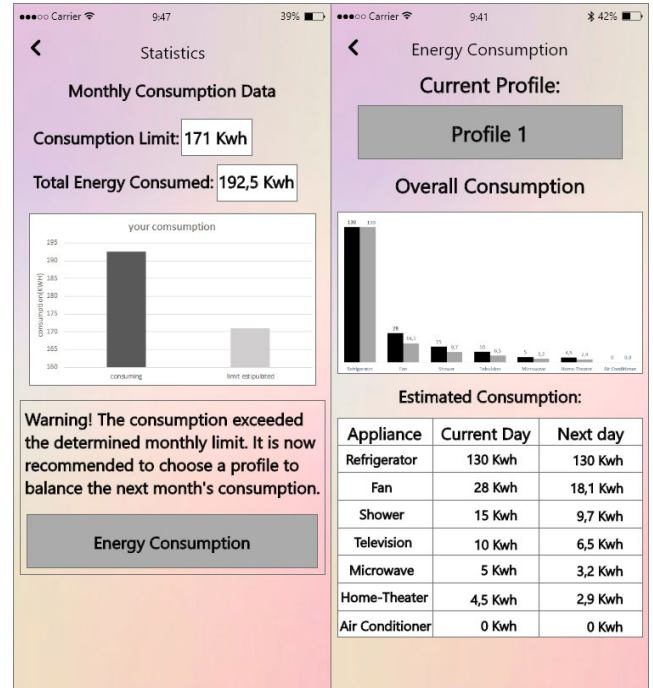

FIGURE 24. Statistics and energy consumption data screens.

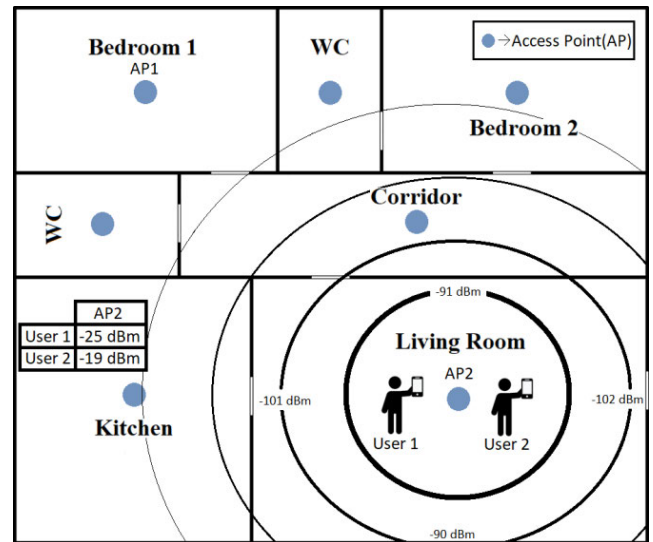

FIGURE 25. Identification of multiple users in the same environment.

It can also be seen in the image to the left of Figure 24 when consumption is exceeded its pre-established value (171KWh). In the image on the right, it can be seen how energy consumption can be reduced since its pre-established consumption for the day is above the standards and needs to be compensated the next day.

It is demonstrated in Figure 25 that when two or more users are in the same room, both are identified and located by the handover system. Using the RSSI fingerprint, it verifies that the two are inserted within the pre-established dBm limits for the living room, with user 1 being identified at  $-25$  dBm from AP2 and user 2 being identified at  $-19$  dBm from AP2.

USER1	USER2	RESULTING
Television 4:00 hours	Television 6:00 hours	Television 10:00 hours
Video game 2:00 hours	Video game 6:00 hours	Video game 8:00 hours
Air conditioner 2:00 hours	Air conditioner 2:00 hours	Air conditioner 4:00 hours

FIGURE 26. Sum of the two user’s appliance limit consumptions.

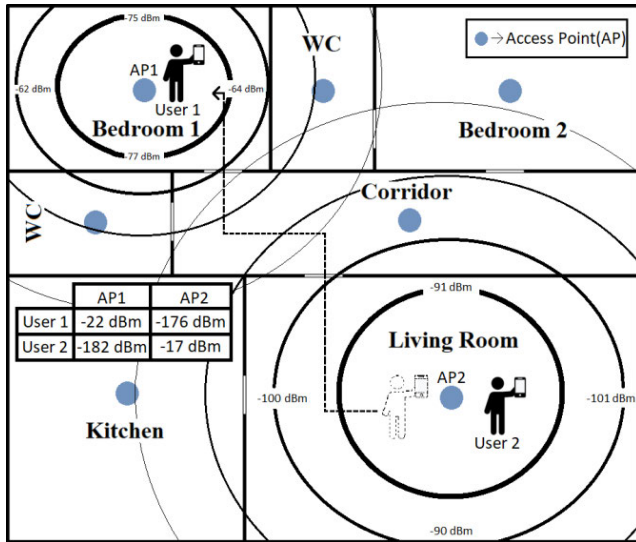

FIGURE 27. System identifying the movement of a user to another room.

Figure 26 shows the estimated time to reach the limit for consumption of television, video games, and air conditioning for the two users who are separated. It is noticed that user 1 has less time to use the television and the video game than user 2, so user 1 joins user 2 who is present in the living room. This results in the possibility that users can use these appliances together, thus reducing energy consumption and increasing each user’s usage time.

This strategy can be used so that instead of the user having to stop using the appliance, his/her consumption can be reduced by dividing proportionately with more people who are also using the same appliances in the same room.

It is demonstrated in Figure 27 that after 2 hours in the same room, it is identified through the RSSI fingerprint that user 1 is no longer in the living room, as his / her dBm value is  $-176$  dBm in relation to the AP2 and is no longer within the pre- established limits to that room. The system then identifies that user 1 is now located in Bedroom 1, as his dBm value for the AP1 is  $-22$  dBm, being within the defined limit. User 2 is still within the limits defined for the living room, not occurring the handover process.

Figure 28 shows the result of the proportional division between users when they are in the same room. To explain this division using the videogame as an example, user 1 and user 2 have their defined limit hours summed up, with the total of this sum being 8 hours. User 1 contributes 25% (2 hours) of this sum, while user 2 contributes 75% (6 hours).

USER1	USER2
Television 3:12 hours	Television 4:48 hours
Video game 1:30 hours	Video game 4:30 hours
Air conditioner 1:00 hour	Air conditioner 1:00 hour

FIGURE 28. Remaining consumption hours for each user after two hours.

User 1 and user 2 used the same video game for two hours simultaneously, resulting in a reduction of 2 hours from 8 hours, which would be the sum of the limits of the two users. Therefore, after these 2 hours, it is identified through RSSI that user 1 is no longer within the mapped limits of the living room (AP2) as shown in Figure 27, occurring the proportional division of the remaining 6 hours.

This division will take into account the initial contribution of each user, so from these 6 hours user 1 will be entitled to 25% (1 hour and 30 minutes) and user 2 will be entitled to 75% (4 hours and 30 minutes) of the remaining total.

## VII. CONCLUSION

This project has the purpose to develop an innovative solution for an SH environment regarding the concepts of decision-making techniques, IoT, device design, measurements, interoperability, and easy -to -use applications.

This architecture implementation has led to the following: a hardware solution with the objective to identify the user location and what appliance is she/he using and how much is she/he consuming, with an interoperable middleware solution which provides solutions to help the consumer to optimize her/his consumption. The architecture also includes several technological requirements, for example a high degree of flexibility and reuse, service transparency, availability of information, and modularity.

In this paper, the focus of key aspects of the SH domain is the designed architecture. Its specific features and functions are not only suitable for monitoring and control contexts but also offer an interface for control through monitoring systems based on traditional solutions derived from the tool. Nevertheless, this alone does not mean that the end-user cannot find the solutions needed to control and monitor the home.

When applying the architecture, it should be stressed that the tracking of the consumption habits of different users connected and actively monitor this is made possible using a mobile or web application. Moreover, it is noteworthy that the data generated by the architecture will allow for effective mechanisms to be designed which constitute an effective method of applying government policies that can assist in reducing energy consumption. Using efficient computational techniques to produce statistical data that can help reduce



electricity waste, the system can also provide benefits to the environment.

In addition, several benefits are provided for an SG situation, in particular for SHs, through the adoption of this architecture. The benefits are as follows:

- (a) An intuitive user interface for mobile applications to control and monitor the devices and rate of consumption of each appliance of the end-user.
- (b) An ability to predict the final amount of energy consumption by using a smart module.
- (c) A Design and control consumption system for both the customer and the power companies.
- (d) A tracking system for residential homes with multiple residents to improve the management of electricity consumption.
- (e) The development of a low-cost open standard solution for transmission and metering devices.

Every software component and device used in this project is interoperable and scalable and they have all been open standards-based, a key element being their low price. Such factors can allow the proposed architecture to be used in commercial areas on a large scale. Additionally, the architecture has already been successfully employed in real-world situations and is thus suitable for use and managed to rebalance residential energy consumption 87.3% of the time it was used.

## REFERENCES

- [1] P. Kumar, Y. Lin, G. Bai, A. Paverd, J. S. Dong, and A. Martin, "Smart grid metering networks: A survey on security, privacy and open research issues," *IEEE Commun. Surveys Tuts.*, vol. 21, no. 3, pp. 2886–2927, 3rd Quart., 2019, doi: [10.1109/COMST.2019.2899354](https://doi.org/10.1109/COMST.2019.2899354).
- [2] M. H. Cintuglu, O. A. Mohammed, K. Akkaya, and A. S. Uluagac, "A survey on smart grid cyber-physical system testbeds," *IEEE Commun. Surveys Tuts.*, vol. 19, no. 1, pp. 446–464, 1st Quart., 2017, doi: [10.1109/COMST.2016.2627399](https://doi.org/10.1109/COMST.2016.2627399).
- [3] A. Annaswamy, *IEEE Vision for Smart Grid Control: 2030 and Beyond Roadmap*, IEEE Standard, Oct. 2013, vol. 1, no. 1, pp. 1–12, doi: [10.1109/IEEESTD.2013.6648362](https://doi.org/10.1109/IEEESTD.2013.6648362).
- [4] M. Al-Kuwari, A. Ramadan, Y. Ismael, L. Al-Sughair, A. Gastli, and M. Benammar, "Smart-home automation using IoT-based sensing and monitoring platform," in *Proc. IEEE 12th Int. Conf. Comput., Power Electron. Power Eng. (CPE-POWERENG)*, Apr. 2018, pp. 1–6, doi: [10.1109/CPE.2018.8372548](https://doi.org/10.1109/CPE.2018.8372548).
- [5] D. Mocrii, Y. Chen, and P. Musilek, "IoT-based smart homes: A review of system architecture, software, communications, privacy and security," *Internet Things*, vols. 1–2, pp. 81–98, Sep. 2018, doi: [10.1016/j.iot.2018.08.009](https://doi.org/10.1016/j.iot.2018.08.009).
- [6] S. H. Andrade, E. da Luz Oliveira, R. Alfaia, A. Souto, C. R. L. Frances, and N. L. Vijaykumar, "Adopting fuzzy technique to save energy in smart home control systems," in *Proc. IEEE 58th Int. Sci. Conf. Power Electr. Eng. Riga Tech. Univ. (RTUCON)*, Oct. 2017, pp. 1–6, doi: [10.1109/RTUCON.2017.8124795](https://doi.org/10.1109/RTUCON.2017.8124795).
- [7] E. D. L. Oliveira, R. D. Alfaia, A. V. F. Souto, M. S. Silva, C. R. L. Francás, and N. L. Vijaykumar, "SmartCoM: Smart consumption management architecture for providing a user-friendly smart home based on metering and computational intelligence," *J. Microw., Optoelectron. Electro-magn. Appl.*, vol. 16, no. 3, pp. 736–755, Sep. 2017, doi: [10.1590/2179-10742017v16i3965](https://doi.org/10.1590/2179-10742017v16i3965).
- [8] Y. Li, Z. Sun, L. Han, and N. Mei, "Fuzzy comprehensive evaluation method for energy management systems based on an Internet of Things," *IEEE Access*, vol. 5, pp. 21312–21322, 2017, doi: [10.1109/ACCESS.2017.2728081](https://doi.org/10.1109/ACCESS.2017.2728081).
- [9] M. Botticelli, L. Ciabattoni, F. Ferracuti, A. Monteriu, S. Pizzuti, and S. Romano, "A smart home services demonstration: Monitoring, control and security services offered to the user," in *Proc. IEEE 8th Int. Conf. Consum. Electron.*, Sep. 2018, pp. 1–4, doi: [10.1109/ICCE-Berlin.2018.8576259](https://doi.org/10.1109/ICCE-Berlin.2018.8576259).
- [10] J. Iqbal, M. Khan, M. Talha, H. Farman, B. Jan, A. Muhammad, and H. A. Khattak, "A generic Internet of Things architecture for controlling electrical energy consumption in smart homes," *Sustain. Cities Soc.*, vol. 43, pp. 443–450, Nov. 2018, doi: [10.1016/j.scs.2018.09.020](https://doi.org/10.1016/j.scs.2018.09.020).
- [11] T. AlSkaif, I. Lampropoulos, M. van den Broek, and W. van Sark, "Gamification-based framework for engagement of residential customers in energy applications," *Energy Res. Social Sci.*, vol. 44, pp. 187–195, Oct. 2018, doi: [10.1016/j.erss.2018.04.043](https://doi.org/10.1016/j.erss.2018.04.043).
- [12] M. K. Annaqeeb, R. Markovic, V. Novakovic, and E. Azar, "Non-intrusive data monitoring and analysis of occupant energy-use behaviors in shared office spaces," *IEEE Access*, vol. 8, pp. 141246–141257, 2020, doi: [10.1109/ACCESS.2020.3012905](https://doi.org/10.1109/ACCESS.2020.3012905).
- [13] S. Wan, P. Xu, K. Wang, and S. Li, "Estimation of distributed thermal boundary based on fuzzy clustering of temperature observable points," *Int. J. Heat Mass Transf.*, vol. 147, Feb. 2020, Art. no. 118920, doi: [10.1016/j.ijheatmasstransfer.2019.118920](https://doi.org/10.1016/j.ijheatmasstransfer.2019.118920).
- [14] K. T. Prajwal and V. S. N. V. S. Gupta, "Smart home energy management system using fuzzy logic for continuous power supply with economic utilisation of electrical energy," in *Proc. 2nd Int. Conf. Inventive Syst. Control (ICISC)*, Jan. 2018, pp. 274–279, doi: [10.1109/ICISC.2018.8399078](https://doi.org/10.1109/ICISC.2018.8399078).
- [15] A. Patel and T. A. Champaneria, "Fuzzy logic based algorithm for context awareness in IoT for smart home environment," in *Proc. IEEE Region 10 Conf. (TENCON)*, Nov. 2016, pp. 1057–1060, doi: [10.1109/TENCON.2016.7848168](https://doi.org/10.1109/TENCON.2016.7848168).
- [16] K. Khan, T. Hossen, A. Savasci, L. Gauchia, and S. Paudyal, "Design of a simplified hierarchical Bayesian network for residential energy storage degradation," in *Proc. IEEE Power Energy Soc. Gen. Meeting (PESGM)*, Aug. 2019, pp. 1–5, doi: [10.1109/PESGM40551.2019.8973603](https://doi.org/10.1109/PESGM40551.2019.8973603).
- [17] M. Shahjalal, M. K. Hasan, M. M. Islam, M. M. Alam, M. F. Ahmed, and Y. M. Jang, "An overview of AI-enabled remote Smart-home monitoring system using LoRa," in *Proc. Int. Conf. Artif. Intell. Inf. Commun. (ICAIC)*, Feb. 2020, pp. 510–513, doi: [10.1109/ICAIC48513.2020.9065199](https://doi.org/10.1109/ICAIC48513.2020.9065199).
- [18] V. Govindraj, M. Sathiyarayanan, and B. Abubakar, "Customary homes to smart homes using Internet of Things (IoT) and mobile application," in *Proc. Int. Conf. Smart Technol. For Smart Nation (Smart-TechCon)*, Aug. 2017, pp. 1059–1063, doi: [10.1109/SmartTechCon.2017.8358532](https://doi.org/10.1109/SmartTechCon.2017.8358532).
- [19] S. Somani, P. Solunke, S. Oke, P. Medhi, and P. P. Laturkar, "IoT based smart security and home automation," in *Proc. 4th Int. Conf. Comput. Commun. Control Autom. (ICCUBEA)*, Aug. 2018, pp. 1–4, doi: [10.1109/ICCUBEA.2018.8697610](https://doi.org/10.1109/ICCUBEA.2018.8697610).
- [20] R. A. Rashid, L. Chin, M. A. Sarijari, R. Sudirman, and T. Ide, "Machine learning for smart energy monitoring of home appliances using IoT," in *Proc. 11th Int. Conf. Ubiquitous Future Netw. (ICUFN)*, Jul. 2019, pp. 66–71, doi: [10.1109/ICUFN.2019.8806026](https://doi.org/10.1109/ICUFN.2019.8806026).
- [21] A. Javed, H. Larjani, and A. Wixted, "Improving energy consumption of a commercial building with IoT and machine learning," *IT Prof.*, vol. 20, no. 5, pp. 30–38, Sep. 2018, doi: [10.1109/MITP.2018.053891335](https://doi.org/10.1109/MITP.2018.053891335).
- [22] A. Haidine, A. Aqqal, and A. Dahbi, "Performance evaluation of low-power wide area based on LoRa technology for smart metering," in *Proc. 6th Int. Conf. Wireless Netw. Mobile Commun. (WINCOM)*, Oct. 2018, pp. 1–6, doi: [10.1109/WINCOM.2018.8629693](https://doi.org/10.1109/WINCOM.2018.8629693).
- [23] N. Prayongpun and V. Sittakul, "Smart Plug for Household Appliances," in *Proc. Adv. Intell. Syst. Comput.*, 2017, pp. 317–325.
- [24] M. A. U. Alam, N. Roy, and A. Misra, "Tracking and behavior augmented activity recognition for multiple inhabitants," *IEEE Trans. Mobile Comput.*, vol. 20, no. 1, pp. 247–262, Jan. 2021, doi: [10.1109/TMC.2019.2936382](https://doi.org/10.1109/TMC.2019.2936382).
- [25] K. Murao, T. Terada, A. Yano, and R. Matsukura, "Detecting room-to-room movement by passive infrared sensors in home environments," in *Proc. 1st Workshop recent Adv. Behav. Predict.*, Apr. 2012, pp. 1–12. [Online]. Available: [https://www.ibr.cs.tu-bs.de/dusbeigl/Awarecast/awarecast2012\\_submission\\_5.pdf](https://www.ibr.cs.tu-bs.de/dusbeigl/Awarecast/awarecast2012_submission_5.pdf)
- [26] D. Dintsis and V. Simankov, "The control automation system method based on combined implementation of fuzzy logic and discrete automation systems," in *Proc. Eur. Model. Symp.*, Nov. 2013, pp. 87–90, doi: [10.1109/EMS.2013.15](https://doi.org/10.1109/EMS.2013.15).
- [27] L. Wu, Y. Wang, and H. Liu, "Occupancy detection and localization by monitoring nonlinear energy flow of a shuttered passive infrared sensor," *IEEE Sensors J.*, vol. 18, no. 21, pp. 8656–8666, Nov. 2018, doi: [10.1109/JSEN.2018.2869555](https://doi.org/10.1109/JSEN.2018.2869555).

- [28] V. Bianchi, P. Ciampolini, and I. De Munari, "RSSI-based indoor localization and identification for ZigBee wireless sensor networks in smart homes," *IEEE Trans. Instrum. Meas.*, vol. 68, no. 2, pp. 566–575, Feb. 2019, doi: [10.1109/TIM.2018.2851675](https://doi.org/10.1109/TIM.2018.2851675).
- [29] S. H. Shah and I. Yaqoob, "A survey: Internet of Things (IOT) technologies, applications and challenges," in *Proc. IEEE Smart Energy Grid Eng. (SEGE)*, Aug. 2016, pp. 381–385, doi: [10.1109/SEGE.2016.7589556](https://doi.org/10.1109/SEGE.2016.7589556).
- [30] S. Verma, Y. Kawamoto, Z. M. Fadlullah, H. Nishiyama, and N. Kato, "A survey on network methodologies for real-time analytics of massive IoT data and open research issues," *IEEE Commun. Surveys Tuts.*, vol. 19, no. 3, pp. 1457–1477, 3rd Quart., 2017, doi: [10.1109/COMST.2017.2694469](https://doi.org/10.1109/COMST.2017.2694469).
- [31] T.-Y. Kim, S.-H. Bae, and Y.-E. An, "Design of smart home implementation within IoT natural language interface," *IEEE Access*, vol. 8, pp. 84929–84949, 2020, doi: [10.1109/ACCESS.2020.2992512](https://doi.org/10.1109/ACCESS.2020.2992512).



**SÉRGIO H. M. S. ANDRADE** was born in Belém, Pará, Brazil, in 1989. He received the degree in control and automation engineering from the Institute of Superior Studies of Amazon, in 2011, and the master's degree in electrical engineering, with an emphasis in applied computing from the Federal University of Pará, in 2017. He is currently pursuing the Ph.D. degree in electrical engineering, with an emphasis in applied computing. He is also a Professor of Technical Schools, Colleges, Universities, and Graduate Studies. He is currently a Professor with the Faculty of Automation Engineering and Computer Engineering, Estácio Nazaré University. He is a Coordinator of Control and Automation Engineering and Telecommunications. He is a Commentator on CBN Amazônia radio about Automation and Robotics. He is also a Partner-Owner of Salt Engenharia e Automação LTDA. He is a member of the Editorial Board of the *Journal of Autonomous Intelligence*. He is also a Reviewer of the *Journal Solar Energy*.



**GUSTAVO O. CONTENTE** was born in Belém, Pará, Brazil, in 1997. He is currently pursuing the degree in computer engineering course with Estácio Nazaré University.



**LUCAS B. RODRIGUES** was born in João Pessoa, Paraíba, Brazil, in 1998. He is currently pursuing the degree in computer engineering course with Estácio Nazaré University.



**LUIGUY X. LIMA** was born in Belém, Pará, Brazil. He received the bachelors' degree in electrical engineering from Estácio Nazaré University, in 2018.



**NANDAMUDI L. VIJAYKUMAR** received the degree in computer technology from the Technological Institute of Aeronautics, in 1978, the master's degree in applied computing from the National Institute for Space Research, in 1984, and the Ph.D. degree in electronic and computer engineering (area: informatics) from the Technological Institute of Aeronautics, in 1999. He participated in the Postdoctoral program at University College Cork (UCC), Coastal and Marine Research Center (CMRC), at University College Cork (UCC), Cork, Ireland, in the area of Coastal Computational Modeling. The Postdoctoral program was funded by the European Union. He retired in May 2017, fearing that the Pension Reform would harm the benefits acquired. He currently maintains a link as a Volunteer Research Collaborator with the Associated Laboratory of Computation and Applied Mathematics (LAC), National Institute for Space Research (INPE). He has experience in the field of Computer Science, with an emphasis on Performance Evaluation, Software Testing with Formal Specification, Time Series Analysis, and Computational Modeling of Coastal Environment. Since July 2019, he has been serving as a Visiting Associate Professor with the Institute of Science and Technology, UNIFESP, São José dos Campos.



**CARLOS RENATO L. FRANCÊS** received the bachelor's degree in computer science from the Federal University of Pará, in 1995, the master's degree in science from the Department of Computing and Computational Mathematics, University of São Paulo, in 1998, and the Ph.D. degree in computer science and computational mathematics from the University of São Paulo, in 2001. He has a 1-D Research Productivity scholarship. He did a Postdoctoral Internship at the Institute of Systems and Computer Engineering, Technology and Science (INESC-TEC), Porto / Portugal, in 2012. He is currently a Full Professor with the Faculty of Computer Engineering, Federal University of Pará, where he was the President of the State of Pará Data Processing Company, from January 2007 and December 2010 and, until 2011, he was a member of the Computing Advisory Committee the National Institute of Educational Studies and Research (INEP-MEC). He was the Dean of Graduate Studies, Research, and Technological Innovation, Federal University of the South, and the Southeast of Pará (Unifesspa), from 2013 to 2016. He was Pro-Tempore Rector of the Federal University of the South and the Southeast of Pará (Unifesspa), from June 2016 to October 2016. He has experience in the areas of Telecommunications Systems and Computer Science: - In Telecommunications Systems: Planning, optimization and performance evaluation of Smart Cities, wireless networks, heterogeneous networks - HetNet, 4G / 5G, PowerLine Communication-PLC, optical clouds, among others. - In Computer Science: Computational Intelligence and extraction techniques, correlation and pattern recognition in social, economic, and environmental systems, such as: energy, public health, social security, public security, deforestation, and deforestation and economics.

...