

Received April 27, 2020, accepted May 11, 2020, date of publication May 22, 2020, date of current version June 3, 2020.

Digital Object Identifier 10.1109/ACCESS.2020.2996573

Renewable Energy Performance of the Green Buildings: Key-Enabler on Useful Consumption Yield

MOHD EFFENDI AMRAN¹, (Member, IEEE), MOHD NABIL MUHTAZARUDDIN², SAMIRA ALBATI KAMARUDDIN², FIRDAUS MUHAMMAD-SUKKI³, SITI HAWA ABU-BAKAR⁴, AHMAD SYAHRIR AYUB³, NURUL AINI BANI³, AHMAD SHAKIR MOHD SAUDI⁵, AND JORGE ALFREDO ARDILA-REY⁶, (Member, IEEE)

¹Engineering Services Division, Ministry of Health Malaysia, Putrajaya 62590, Malaysia

²Razak Faculty of Technology and Informatics, Universiti Teknologi Malaysia, Kuala Lumpur 54100, Malaysia

³School of Engineering, Robert Gordon University, Aberdeen AB10 7GJ, U.K.

⁴Electrical Engineering Section, British Malaysian Institute, Universiti Kuala Lumpur, Selangor 53100, Malaysia

⁵Institute of Medical Science Technology (UniKL MESTECH), Universiti Kuala Lumpur, Selangor 43000, Malaysia

⁶Department of Electrical Engineering, Universidad Técnica Federico Santa María, Santiago de Chile 8940000, Chile

Corresponding authors: Mohd Effendi Amran (meffendi.amran@gmail.com), Mohd Nabil Muhtazaruddin (mohdnabil.kl@utm.my), and Firdaus Muhammad-Sukki (f.b.muhammad-sukki@rgu.ac.uk)

This work was supported in part by the Universiti Teknologi Malaysia (UTM) through TDR under Grant 06G05, in part by the Agencia Nacional de Investigación y Desarrollo (ANID) through the Project FONDECYT Regular under Grant 1200055, in part by the Project FONDEF under Grant ID19110165, and in part by the Project PL_m_19_01 (UTFSM).

ABSTRACT Malaysia's Eleventh Plan started to encourage green building developments and green industries to stimulate green growth. Eventually, the Malaysian government had launched a new commitment to accelerate the green and efficient energy sector and revised the quota of Renewable Energy (RE) towards higher capacity for electricity generation. These scenarios had highlighted the latest commitment of the Malaysian government to implement both green building development and concurrently, streamline the additional quota for RE generation. Due to this, the evolution of the requirement of RE-based Distributed Generation (DG) in the green building development for higher installed-capacity was expected to occur in ensuring the government key achievement becomes more visible. This study focuses on measuring the expanded-capacity performance of the Solar Photovoltaic (PV)-type DG unit (PV-DG) through the Green Building Rating System (GBRS), particularly on the useful energy consumption yield for load and total line loss minimization. Previous work has conducted a MATLAB simulation on a PV-DG capacity expansion guided by the Net Energy Metering (NEM) specification considering the total line loss minimization as the main objective function. These results are being adopted to obtain the ratio of useful energy consumption from the generated PV-DG through the selected distribution network. Consequently, the Performance Ratio (PR) - as the internationally recognized formulation for a complete PV-DG system - is proposed to be revolutionized towards extended version, considering the specific total line losses minimization, via the formed of the proposed ratio.

INDEX TERMS Green building rating system, net energy metering, distributed generation, payback period, performance ratio.

I. INTRODUCTION

Global environmental issues have introduced a climate change as an important topic which prioritized the emission

The associate editor coordinating the review of this manuscript and approving it for publication was Young Jin Chun .

of greenhouse gas (GHG) as well as the carbon dioxide (CO₂) and protecting the global environment as a major control measure [1]. Any attempt to combat global warming critically depends on China's trajectory growth in terms of the distinct drivers of domestic CO₂ emissions since China is now known today as the largest single emitter

of CO₂ [2]. The understanding of drivers for CO₂ emissions underlies the stemming from the burning of fossil fuels and the manufacture of cement including the produced during consumption of solid, liquid, gas fuels and gas flaring which is critical for economic and environmental sustainability [3]. This also includes the emissions produced by ocean-going vessels not only negatively affect the environment but also may deteriorate the health of living organisms, whereas several regulations were released by the International Maritime Organization (IMO) to alleviate negative externalities from maritime transportation [4]. This seen of importance where Abioye *et al.* [5] had highlighted that more than 80% of the global trade tonnage and 70% of the global trade value are carried by oceangoing vessels around the world according to the United Nations Conference on Trade and Development (UNCTAD). Besides, CO₂ emissions from maritime transportation constitute approximately 2.2% of the overall world anthropogenic carbon dioxide emissions [6]. On the other hand, the global aviation industry had counted for over 3 billion air passengers, which produced 705 million tons of CO₂ in 2013 with 2% of the human-induced CO₂ emissions and 13% of total transportation-related emissions as according to the Air Transportation Action Group (ATAG) [7].

Various studies on the relationship between CO₂ emissions and their main drivers for different individual countries have been conducted, where Mikayilov *et al.* [8] highlighted these studies which include Russia [9], Turkey [10], Spain [11], France [12], Canada [13], China [14], India [15], and for Brazil, China, Egypt, Japan, Mexico, Nigeria, South Korea, and South Africa [16]. In Malaysia context, sustainability has been formally embraced in Malaysia Eleventh Plan where green growth is set as a fundamental shift especially in the human capital, policy, and regulatory framework, green technology investment, and financial instruments [17]. In line with the said initiative, [17] also highlighted that the Ministry of Energy, Green Technology, and Water (now known as Ministry of Energy, Science, Technology, Environment and Climate Change Malaysia (MESTECC)), will advance the development for green products and services in the domestic market. Measures to be undertaken include implementing Government green procurement for at least 20% by year 2020, encouraging the green building developments and industries greening to stimulate green growth. Moreover, due to environmental factors and conflicting in the price of oil at the international market, the concept of low energy building and green building are emphasized by the Malaysian government [18].

Consequently, the green and efficient energy sector in Malaysia has set a 2% share of RE installed-capacity in the previous year (before 2015) while targeted for 5.5% by the year 2015 and finally striving towards 11% of standing quota to be achieved by 2020 [19]. In line with that, the Feed-in Tariff (FiT) implementation which has been commenced from 1st December 2011 has foreseen the uprising RE quota towards 17% by 2020 [20]. However, the most recent, MESTECCs' 2019 initiative has launched a commitment to

enlarge the green and efficient energy sector by increasing the percentage of RE from 2% towards 20% for electricity generation by 2025 [21]–[23]. These scenarios highlight the latest commitment of the Malaysian government to implement both green building development for government facilities and concurrently, streamline the additional quota for RE distributed generation (DG).

Furthermore, Amran *et al.* [24] has highlighted the encouragement for RE utilization through scoring credit in main assessment criteria among the selected Green Building Rating System (GBRS) originated from Southeast Asian Countries (ASEAN), i.e. Malaysian Carbon Reduction Environmental Sustainability Tool (MyCREST), Green Building Index (GBI) Malaysia, GreenRE Malaysia, Green Ship Indonesia, Thai's Rating of Energy and Environmental Sustainability (TREES) and Green Mark Singapore [25]–[30]. In addition, GBRS originated from United State of America (USA) i.e. Leadership in Energy and Environmental Design (LEED v4), has also being considered into the list due to its remarks as the pioneer and the great influencer for newer GBRS throughout the world [31]. The intent of the RE assessments from these selected GBRS has been concluded towards prioritizing, encouraging, acknowledging effort in utilizing RE and reducing environmental impact approaches. This has portrayed the current imposed of small scale RE category as referred to their respective assessment criteria concerning the current maximum demand (MD) [24]–[30], [32]. In conjunction with the above-mentioned commitment by MESTECC towards 2025 as accordance to Amran *et al.* [33], the growth in RE-based DG is significantly being enabled towards higher installed-capacity, in ensuring the government key achievement can be visibly fulfilled.

The previous work [33]–[37] has overcome various kinds of optimization techniques in determining the PV-DG sizing and placement guided by the total line losses as the main objective function. However, the significant key-findings from the total line loss and performance outcome among these selected references towards the more accurate payback period outcome was not highlighted, thus, leaving a gap for justifying the role of both total line loss minimization and the higher performance factor towards their potential values to determine the payback period milestone. Since simultaneous optimization criteria for RE-based DG location and capacity was found to be more effective to be observed via minimal losses outcome [34] and also implemented in many recent kinds of literature [33]–[37], therefore, an extended assessment on this loss minimization and performance outcome towards monetary benefits need to be synchronized for more reliable and justified analysis in PV-DG measure as well as during early-stage design and estimation process.

The required evolution in the RE landscape as part of the green building criteria through GBRS is a focus of this study where the initial assessment is made to the current RE setting for measuring the technical and financial worth. In contrast, the impact of this factor also significantly determined the payback period for capital expenditure (CAPEX) and

operational expenditure (OPEX) milestone. Subsequently, adoption of the current scheme related to solar photovoltaic (PV) as DG (PV-DG) is made followed by a further assessment to identify the potential factor in rectifying the performance ratio (PR) towards extended version and justifies the PV-DG expansion-limit which best suit for the distribution network.

This paper proposes a measure for the ratio (i.e. ϕ) of useful energy consumption for load and loss minimization from the PV-DG generation which enables the formulation in obtaining a more precise value of useful energy consumption yield for load and loss minimization figure within the selected distribution network. This factor is also aimed to be brought forward as a potential factor in the final yield (Y_f) input parameter which significantly improves the PR towards extended version for a more accurate figure in terms of both performance and the beneficial impact on the payback period measure. The findings of this research will guide the green building development towards a better aim, effectiveness, efficient and more sensible approach through improved estimation in PV-DG design as well as payback period determination for CAPEX and OPEX in line with up-to-date government policies. To achieve the goal, the optimization outcome and the PV-DG expansion-limit baselines from [33] are selected as the raw input data for further payback period assessment which is explained in the later discussion. The reason behind the selection is that the outcome in [33] has introduced an expansion-limit which also facilitates an input parameter of PV-DG expand capacity via NEM scheme beyond the current GBRS base case which is factored-in the performance calculation.

The rest of this paper is organized as follows: Section II introduces a literature review that touches on issues related to PV-DG in GBRS (Sub-section A), describes brief explanations on the indices for PV-DG performance (Sub-section B) and the payback period assessment (Sub-section C). Besides, Sub-section D discussed the research gap and contribution of the study. Section III describes the methodology used and the problem formulation for the proposed solution. Section IV presents the results and discussions. Section V concludes the paper.

II. LITERATURE REVIEW

A. GBRS – ISSUES RELATED TO PV-DG

Based on the essence of sustainable developments, the RE usage such as PV-DG is one of the most influentially common principles [38] and consequential approach in reducing the energy consumption in buildings [39] while having considered as a key component of green building-based design for electricity generation capability [40]. In particular, a comparison in the current RE assessment between selected seven sets of GBRS has been conducted in [24] which comprised of different tools within six ASEAN originated countries and one from USA respectively. These seven different GBRS namely, MyCREST, GBI, GreenRE, GreenShip, Green Mark,

TABLE 1. The intent/aim of RE application between seven different GBRS.

GBRS	Intent / Aim of RE Application
MyCREST	To provide/maintain the generation of electricity from renewable resources and reducing the effect on environment pollution by reducing greenhouse gas emissions.
GBI	Encourage the use of RE.
GreenRE	Encourage the application of RE sources in buildings.
Green Ship	Not stated.
Green Mark	On-site generation of RE can reduce the building development's power consumption from the grid and carbon emissions.
TREES	Give priority to use RE to reduce environmental and social impacts associated with fossil fuel energy use.
LEED v4	To encourage the reduction of greenhouse gas emissions through the use of local and grid-source RE technologies and carbon mitigation projects.

TREES and LEED v4 were holistically compared in terms of the intent/aim of RE application and to portray the current pattern of RE criteria setting including the scoring (credit) as shown in Table 1 and Table 2 respectively. Furthermore, three groups with the highest RE capacity requirement were identified via an empirical review in classifying their current RE assessment criteria in terms of the capacity requirement and scoring credit as shown in Table 3.

The recent kinds of literature had justified the remarkable significance of the green building developments to the design of advanced and efficient integrated energy technologies to reduce electricity, loads such as heating, cooling, etc. in the form of energy demand and the consumptions through the on-site RE sources approach [41], [42].

Since utilizing RE as one of the most key elements of green buildings [43], this significantly increases the integration of PV-based DG (PV-DG) to the highest possible capacity into power system network prior to given maximum scoring of respective GBRS [44] and even exceeding the RE maximum scoring in GBRS.

Obviously, the outcome of the above study which was summarized in Tables 1 - 3 had portrayed the small imposed for RE capacity from the current seven different GBRS. Therefore, the two previously mentioned recent policies by MESTECC, i.e. to encourage the green building development for at least 20% by 2020 [17] and to enlarge the green and efficient energy sector by increasing the percentage of RE from 2% towards 20% for electricity generation by 2025 [21]–[23], can possibly result in the change of RE landscape in green building current practice and also will lead towards evolution for extreme expansion scale in RE utilization beyond the current GBRS base case in assessment criteria. From a green building development perspective, the drastic increment of RE quota by 18% from the original target will significantly overlap the RE development, which will subsequently increase the current imposed of utilization such as PV-DG integration beyond the current RE setting in GBRS application. The only scheme that allows for higher capacity than

TABLE 2. The RE criteria setting and scoring (credit) among selected GBRS.

GBRS	Scoring Credit	RE Criteria Setting
MyCREST	4 (max)	3 % from Total Building Energy Use
	3	2 % from Total Building Energy Use
	2	1% from Total Building Energy Use
	1 (min)	0.5% from Total Building Energy Use
GBI	5 (max)	2.0 % of MD or 40 kWp (which is greater)
	4	1.5 % of MD or 20 kWp (which is greater)
	3	1.0 % of MD or 10 kWp (which is greater)
	2	0.5 % of MD or 5 kWp (which is greater)
	1 (min)	0.25 % of MD or 2 kWp (which is greater)
GreenRE	15 (max)	3% via of electricity by RE source
	5 (min)	1% via of electricity by RE source
Green Ship	5 (max)	2.0 % of MD or 40 kWp (which is greater)
	4	1.5 % of MD or 20 kWp (which is greater)
	3	1.0 % of MD or 10 kWp (which is greater)
	2	0.5 % of MD or 5 kWp (which is greater)
	1 (min)	0.25 % of MD or 2 kWp (which is greater)
Green Mark	(For EEI ≥ 120)	
	6 (max)	Replace of building electricity by 3.0% RE
	5	Replace of building electricity by 2.5% RE
	4	Replace of building electricity by 2.0% RE
	3	Replace of building electricity by 1.5% RE
	2	Replace of building electricity by 1.0% RE
1 (min)	Replace of building electricity by 0.5% RE	
TREES	4 (max)	RE not less than 3.5 % of energy cost
	3	RE not less than 2.5 % of energy cost
	2	RE not less than 1.5 % of energy cost
	1 (min)	RE not less than 0.5 % of energy cost
LEED v4	5 (max)	Points
	4	$= \frac{RE\ generated\ \%}{1.5\%}$
	3	$+ \frac{Energy\ purchased\ or\ offset\ \%}{25\%}$
	2	
	1 (min)	Where, Max. RE capacity = 1.5% of total building energy use

TABLE 3. The group for highest RE capacity among selected GBRS.

GBRS	Max PV-DG percentage from MD prior to the highest scoring
MyCREST	
GreenRE	3%
Green Mark	
GBI	2.0 % or
Green Ship	40 kWp (whichever greater)
LEED	1.5%

any GBRS current setting for PV-DG building integration in Malaysia is Net Energy Metering (NEM) which applies to all domestic, commercial and industrial sectors [45].

However, the simulated PV-DG expand capacity through NEM maximum capacity requirement via an optimization approach, as conducted in [33] using three selected Malaysian public hospitals’ distribution networks and bus data has highlighted several issues. MATLAB simulation result for higher PV-DG scale has found that the performance yield for load

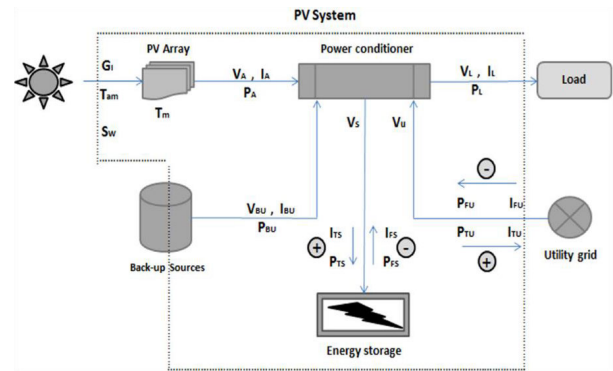

FIGURE 1. A complete PV-DG system and parameters for a measure in which the AC output components through the distribution network were still falling within the boundary of the complete PV system.

and loss minimization tend to decrease upon larger utilization of PV-DG scale towards optimal value via the current linear trend for PV-DG increased capacity. This significantly causing the actual useful energy consumption for load and loss minimization to become decreasingly underutilized upon the increase of PV-DG capacity and potentially prolong the payback period for CAPEX and OPEX through theoretical calculation.

In extend, the RE system performance decreases due to line losses, and due to variation of voltage level, thus the selection for location and capacity of DG sources are found to be more important in dependably on the system losses and voltage stability measure as compared with several others objective function settings [46]. With regards to the previous-mentioned losses issue in a distribution network and considering the required appropriate measure in RE application in green building as previously mentioned by Amir et al. [39], the useful RE consumption yield issue as above have highlighted a gap for assessment towards higher performance measure in RE installation. In contrast, simultaneous optimization criteria for PV-DG location and capacity are still lacking in applying appropriate performance indices into current selected GBRS assessment criteria for more justified value towards both minimal losses and payback period worth.

B. INDICES FOR PV-DG PERFORMANCE

Based on IEC 61724, a complete PV-DG system with different parameters to be measured in real-time is shown in Fig. 1 [47].

Referring to Fig. 1 and focusing on the flow of the voltage V_L and current I_L towards load consumption, the AC output components through the distribution network were still falling within the boundary of the complete PV system, where these parameters shall be considered in the calculation for the whole PV-DG performance measure. Since loss contribution in the grid-connected distribution with high R/X ratio which consists of large varieties of components like thermostatic loads, resistive and inductive loads, induction motors, and lighting loads [48], [49] added with factors of

characteristics in distribution network and load demand levels as accordance to Van Thong *et al.* [50], the value of useful power P_L would be possibly affected, caused by the existence of bi-directional power flow from utility and the PV-DG. Thus, the scenario has introduced a gap to obtain optimal line loss and the useful power yield for higher PV-DG performance measures specifically on the AC distribution side.

Initially, there are several parameters to judge the performance of a PV-DG plant, where [51] had highlighted several of them such as specific yield, capacity utilization factor (CUF), performance ratio (PR), performance index (PI), etc. PR shows the proportion of the energy that is available for export to the grid after the deduction of energy loss (e.g. due to thermal losses and conduction losses) and energy consumption for operation [52]. PR also has been reported as the ratio of final system yield (Y_f) to that of reference yield (Y_r) as shown in (1) as accordance to IEC standard [53], National Renewable Energy Laboratory (NREL) [54], International Energy Agency Photovoltaic Power Systems (IEA PVPS) Task 2 [55], European Guidelines, and Australian PV System Monitoring Guideline [56].

$$\text{Performance Ratio (PR)} = \frac{Y_f}{Y_r} \quad (1)$$

Various definition of Y_f and Y_r as well as PR formulation have been reviewed by Khalid *et al.* [51] where ten references of them were presented by Haeberlin and Beutler [57]; IEC 61724 Methodology [53]; IEA PVPS TASK 2 Methodology and NREL/CP-520-37358 Performance Parameters for Grid-Connected PV Systems [54]; EU Performance Monitoring Guideline for Photovoltaic Methodology - PERFORMANCE Project; Kymakis *et al.* [58]; SMA Methodology via Kymakis *et al.* [58]; Ransome *et al.* [59]; PR-FACT Mack and Decker GmbH In-house Methodology; and Australian PV System Monitoring Guideline Version 1.0 [56]. Besides, the above-selected references had been claimed to be represented as one of the most cited works in the literature on PR for PV plants and are also a perfect mix for global understanding. This also justifies the reason behind the selection of these various sources to portray the PR definition which is summarized in Table 4. However, none of them has considered the line loss contribution in the formulation which translated by the useful consumption yield as it was identified as essential to the AC distribution side as discussed above.

Based on Table 4, it is observed that four out of the ten references (i.e. IEA PVPS TASK 2 Methodology – 2001; NREL/CP-520-37358 report [54]; EU PERFORMANCE Project and Australian PV System Monitoring Guideline [56]) are applying the standard equation used by IEC 61724 to define the PR. Whereby, three references by Haeberlin and Beutler [57]; Kymakis *et al.* [58] and Ransome *et al.* [59] have presented the PR in two ways: one, as defined by IEC 61724 and second, a new definition using correction factors, inefficiencies, and uncertainty functions respectively. PR-FACT Mack and Decker GmbH methodology have defined PR using different correction factors.

SMA has defined the PR in terms of the actual reading of the plant output and nominal output of the plant.

Focusing on the grid or distribution network for PV-DG performances, only two references, i.e. Kymakis *et al.* [58] and PR-FACT Mack and Decker GmbH had highlighted the availability and grid connection loss represented by a factor of η_{ppc} and f_{10} respectively. The rest of the references might include the distribution losses factor in the calculation, however, the detail formulation and input parameter of these factors in terms of line losses and load consumption had identified a gap, which needs to be strengthened by the evidence-based input ratio towards the optimal approach. In addition, the impact of this factor in terms of the payback period milestone would also highlight the importance of optimal losses and the useful energy consumption yield for load and loss minimization to be considered in the formulation. Therefore, the proposed input parameter and the ratio of related fields on behalf of Y_f would give access for improved PR towards the extended version for a more accurate figure and is explained in later discussion.

Responding to the performance measure needs and subjected to PV-DG grid-connected application, PR which is recognized as a globally accepted indicator to measure the overall performance of the system [51], however, the ratio of useful energy consumption which revealed via the PV-DG optimization towards minimal losses outcome has not yet been factored in the PR formulation. Thus, leaving a gap towards PR viability for improved figure, considering an optimal PV-DG outcome towards minimal losses as a key factor as this would determine the limit of PV-DG expansion and the payback period worth for the CAPEX and OPEX.

C. THE PAYBACK PERIOD ASSESSMENT

The definition of payback period can be referred to as the required length of years or time consumed in recovering the initial/original investment. The shorter payback period is considered as a better indication project provided that all constant factors took in place since invested capital can be recovered in a shorter period [60]. The payback is also used as a risk indicator for a project since the expected cash flow in a lengthy timeline is riskier than a shorter timeline which also determines the projected liquidity [61].

Concerning the PV-DG energy generation, Hoffmann [62] defined the energy payback time as a period for the required amount of energy to be produced by a PV module. Therefore, it is also an environment parameter that needs to be taken care of. While the time is dependent on the cumulated insolation where a longer energy payback items at larger geographical latitudes, an absolute value comparison requires a crystal-clear definition for the energy consumptions that are to be taken into account to manufacture the solar module.

Several studies have been conducted on the feasibility of implementing PV-DG systems in different countries. Wijesuriya *et al.* [63] introduced the concept of fixing several reflectors near the panel reflecting sunlight from outside the panel area onto the panel, increasing the energy output.

TABLE 4. PR formulation from various sources.

Sources	PR Formula
Haeberlin and Beutler [57]	$PR = \frac{Y_f}{Y_r} = K_T \times K_G \times \eta_j$ <p>Abbreviations: K_T= Temperature correction factor, K_G= Generation correction factor, η_j= Inverter efficiency</p>
IEC 61724 [53]	$R_p = \frac{Y_f}{Y_r}$ <p>Abbreviations: R_p=PR</p>
IEA PVPS TASK 2 [54] NREL/CP-520-37358 [54] EU PERFORMANCE Project Australian PV System Monitoring Guideline [56]	$PR = \frac{Y_f}{Y_r}$ <p>Abbreviations: Y_f= final yield, Y_r= final yield,</p>
Kymakis <i>et al.</i> [58]	$R_p = \frac{Y_f}{Y_r}$ $R_p = \eta_{deg} \times \eta_{tem} \times \eta_{soil} \times \eta_{net} \times \eta_{inv} \times \eta_{tran} \times \eta_{ppc}$ <p>Abbreviations: η_{deg}= panel degradation loss, η_{tem}= temp loss, η_{soil}= soiling loss, η_{net}= DC wiring and interconnection loss, η_{inv}= inverter loss, η_{tran}= transformer loss, η_{ppc}= availability and grid connection loss of the PV plant</p>
SMA Methodology [58]	$PR = \frac{\text{Actual reading of plant output in KWh p. a.}}{\text{Nominal plant output in kWh p. a.}}$ <p>Abbreviations: <p.a.= annum<="" p="" per=""> </p.a.=></p>
Ransome <i>et al.</i> [59]	$PR = \frac{Y_f}{Y_r} = \frac{kWh_{AC}}{kW_p}$ $kWh_{AC} = kWh_{AC.OPTIMAL} \times \frac{\text{insolation yearly}}{\text{insolation nominal}} \times f_{DOWNTIME} \times f_{DEGRADATION} \times f_{DIRT} \times f_{SEASONAL} \times f_{SHADING} \times f_{BOS}$ <p>Abbreviations: f=uncertainty function due to downtime, panel degradation, soiling, seasonal change, shading, the balance of system effects, reference module calibration, flash effect, module binning and manufacturer declaration of the PV plant</p>
PR-FACT Mack and Decker GmbH	$PR = f_0 \times f_1 \times f_2 \dots f_{10}$ <p>Abbreviations: $f_0, f_1, f_2 \dots f_{10}$= correction factors related to: f_1 and f_2 – plane of angle irradiation; f_2 and f_3 – shading; f_3 and f_4 – PV module; f_5 and f_6 – PV module configuration and DC wiring; f_8, f_9 and f_{10} – AC wiring and transformer of the PV plant.</p>

The objective is to place the reflectors so that they never throw their shadows on the panel or on other reflectors where this approach can increase the resource utilization, especially during the periods where the inception angle significantly deviates from the optimal right angle. A cost-benefit analysis was implemented to decide if the investment would be financially feasible. The analysis comprised calculating the net present values of the annual cash flows along with the calculation of the payback period. The outcomes of the cost-benefit analysis turned out to be positive reducing the overall

payback period from 22 years to 18 years by enhancing output generated power via efficient reflectors setting.

Bakos *et al.* [64] applied computerized renewable energy technologies (RET) to obtain a BIPV grid-connected feasibility analysis. A BIPV with 2.25 kWp capacity consists of 3 sinusoidal inverters (850 W nominal power of each). The energy production amount and the cost of the system were estimated to be 4,000 kWh/year and €24,000 respectively. The payback period was found between 20 and 50.1 years for different subsidy amounts ranging between 0% and 60%.

Peng *et al.* [65] conducted a cooling test on solar PV system for efficiency improvement via cooling condition which achieved an increasing rate of 47% and was proposed for possible system setup of residential solar PV application. The cost payback time uses CUF and direct multiplication with the utility tariff rate which can be reduced to 12.1 years, compared to 15 years of the baseline of a similar system without a cooling sub-system.

Chang and Starcher [66] evaluated the benefits of wind and solar energy and determine economical investment sites for wind and solar energy in Panhandle Texas through calculating payback periods based on quantified actual electricity generation. An AOC 15/50 50kW wind turbine system and a 42 kW PV system at the Alternative Energy Institute (AEI) Wind Test Centre (WTC) were used to collect field data. The payback period was calculated based on energy production, the cost of electricity, and incentives and rebates available for the project. The payback period of the PV system was calculated based on the energy production estimates. The PVWATTS Calculator estimated the energy production of the two-tracker array system. It determined the solar radiation incident on the PV array and the PV cell temperature for each hour of the year using typical meteorological weather data for the selected location. The DC energy for each hour was calculated from the PV system DC rating and the incident solar radiation and then corrected for the PV cell temperature. The AC energy for each hour was calculated by multiplying the DC energy by the overall DC-to-AC conservative derating factor equal to 0.9 and adjusted for inverter efficiency as a function of load. Hourly values of AC energy were then summed to calculate monthly and annual AC energy production.

Seme *et al.* [67] presented a multi-criteria evaluation analysis of the optimal price of electricity of Solar Power Plants (SPP) and Small Hydro Power Plants (SHPP). The objective of this paper is to deal with the technical and economical part of the investment in the construction of a solar power plant and a small hydropower plant. The basis of the investment and operating costs analysis of the viability of investment at different purchase prices of electricity is implemented, with the help of acceptance indicators. The calculation of the payback period was performed for the reference price of electricity and for the price of electricity by which the investment is repaid in 10 years for both SPP and SHPP. The results show that the payback period for the reference price for SPP and SHPP was 30.8 and 18.2 years. This paper also found that the purchase price of electricity for SPP was 2 to 3 times higher than the purchase price of electricity for SHPP.

Numbi and Malinga [68] presented an optimal energy control of a 3kW residential grid-interactive solar PV system is presented. They proposed *true payback period* method for the analysis of the residential grid-interactive solar PV system in this work. In this study, the annual costs are the O&M costs and annual cost savings as in equation uses direct

multiplication between tariff rate and PV output generated power.

Thompson and Duggirala [69] had presented a feasibility study and a cost analysis of renewable energies at a small off-grid facility in Canada where the electricity was supplied to the studied building mainly by diesel engines using natural gas as a fuel. The economic and environmental feasibility of three different scenarios to replace the current 100 kW diesel engine by one of the following new technologies, i.e. biomass combined heat and power, wind energy and PV system were studied and were made comparable using a developed RETScreen software model-based. They concluded that the PV system at \$9,100/kW is the most expensive among the technologies, requiring a long payback period of 13.5 years. Whereas compared with installing a new diesel generator or implementing a biomass system, wind power was found to be more expensive at \$3,300/kW with 6.1 years payback period. Thus, biomass combined energy is more economically and environmentally feasible than wind or PV technologies with the lowest payback period of about 4.1 years. It is also found that the payback period calculation had considered the PV efficiency of 12.3%. However, line loss contribution was not taken into account.

Mirzahosseini and Taheri [70] investigated three scenarios of alternative energy solution for Iran, in terms of the financial feasibility and environmental aspect of using a PV solar power station via RETScreen. They examined the electricity price rate at 3.74 cents/kWh, making the equity payback period significantly higher at about 12.1 years as the first scenario. Then, the second scenario was to increase the electricity tariffs to 17.5 cents/kWh, resulting in the equity payback period decreased to 8 years. Finally, in making use of an incentive benefit of \$30 for each ton of CO₂ removal, they considered the issue of GHG reduction, which results with decreasing in the equity payback period to 6 years. However, it was found that this investigation does not consider PV efficiency and line loss contribution in the payback period calculation.

Bakos and Soursos [71] dealt with a stand-alone PV and a hybrid system for a technical and economical evaluation for lowering the electricity prices at resorts in Greece. Simulation using the software in renewable energy technologies, economic issues were examined via three different payment schemes scenarios specifically on the percentage of the initial capital cost. Without consideration of PV efficiency and line loss contribution, the payback period and net present value (NPV) for several financial scenarios are predicted to gain the gross returns on the investment.

Dusonchet and Telaretti [72] conducted a survey for five representative EU countries, i.e., Germany, the UK, France, Italy, and Greece in terms of the economic indices, best profitability, NPV and the payback period for PV systems towards varying size for backup policies evaluation for PV systems for comparative economic analysis. This survey has resulted in an indication of the achievable of the best profitability for

these countries due to an active compensation scheme despite the high cost of electricity.

Adam and Apaydin [73] applied RETScreen software for financial analysis and determination of the GHG eliminated by using a PV system to perform an estimated reduction volume for the carbon dioxide emission via PV system (grid-connected) in Gaziantep, Turkey, instead of using a barrel of petroleum. In this study, the proposed case of power system uses electricity exported to the grid which equivalent to 881.5 MWh, while PV capacity of 500 kWp with a capacity factor of 20.1%. The efficiency or ratio of line losses is not considered. The result represented by the cumulative cash flow graph showed that the 3.2 years is the achievable equity payback period, plus with the advantage that the PV system being free of GHG. On top of that, the authors suggested that legislation to promote the use of PV systems and increase electricity tariffs should be enacted by the government.

Rehman *et al.* [74] using RETScreen software for the cost of solar energy generated study via 5 MWp grid-connected PV panels in Saudi Arabia. The model calculates the annual renewable energy delivered (MWh), which is the amount of equivalent DC electrical energy delivered by the PV system to the load, or the utility in the case of the grid-connected system. The maximum annual energy production of 12.4 GWh was obtained from Bishah power plant (with power plant efficiencies of 28.3%) while the minimum of 8.2 GWh from Tabuk and Sarrar power plants (with power plant efficiencies of 18.7%). From the payback period calculation, NPV, profitability index, and life cycle savings, the economic analysis revealed that Bisha is the best location for a PV power plant where the results showed that 8182 tons of GHG per year can be eliminated due to establishment of such a plant.

Crawford *et al.* [75], identified the payback period through life cycle assessment from two different types of combination PV cells-heat recovery unit. Two 75 W Si PV modules with a total area of 1.26 m² were used as the first system, next, a heat recovery unit was added in the second system to benefit from the wasted heat produced by the PV modules. In the third system, a-Si PV modules were used instead of c-Si PV modules. The result of the energy payback period for the first system was found to be between 12 and 16.5 years. Whereas the second system achieved between 4 and 9 years and finally the third system between 6 and 14 years.

Chel *et al.* [76] applied a methodology to an actual case study of 2.32 kWp PV system for life cycle cost assessment and sizing of BIPV systems through a simplified model. Two defined sub arrays comprised of 32 PV modules (35 Wp each) and 16 PV modules (75 Wp each) respectively, whereas, the capital cost for the BIPV system was \$6,963/kWp. In addition, the unit cost of electricity from BIPV was estimated to be \$0.46/kWh. However, when the carbon credit potential of the system was considered, the unit cost decreased to \$0.37/kWh. The calculated payback period was equivalent to 10 years considering total annual energy generated by the system equal to 3,285 kWh.

San Ong and Thum [61] had determined the net present value (NPV), the total cost, price/kWp system, and the payback period for PV projects in Malaysia. The selected 7 projects, i.e. Project 1 to 7 have been used in the analysis where the findings of all 7 projects had shown a negative NPV value with a payback period of more than 38 years. The analysis also found that 4 projects even achieving a payback period of more than 50 years. However, a positive NPV is possibly achieved if the price/kWp system managed to be reduced to RM11,000 and RM4,000 for government-subsidized and non-subsidized projects respectively. The estimation on the payback period was achievable between 4 and 8 years with a current market price reduction of between 85% and 50% respectively.

Hou *et al.* [77] analyzed the life cycle inventory during every process were estimated in detail followed by the energy consumption and greenhouse gas (GHG) emission and the life-cycle value was calculated accordingly. The results for the grid-connected PV power showed that the crystalline silicon solar modules resulting in ranges from 1.6 to 2.3 years for the energy payback time (EPBT). Depending on the installation methods, GHG emissions, on the other hand, resulted in a range from 60.1 to 87.3g-CO_{2,eq}/kWh.

Rodrigues *et al.* [78] had overcome with analysis to identify the best investment opportunities via considering the new regulations among a representative set of countries, including Australia, Brazil, China, Germany, India, Italy, Japan, Portugal, South Africa, Spain, the UK and the USA. Furthermore, 2 case studies were employed with different sizes of solar photovoltaic systems, i.e. 1 kW and 5 kW where each case study includes 4 different consumption scenarios ranging from 100% self-consumption to 30%. The results found that Australia, Germany, and Italy had shown the most profit that can be made in.

Wang *et al.* [79] investigated the first standalone hybrid renewable energy commercial microgrid in Hong Kong via a life cycle assessment (LCA) case study of the Town Island Microgrid for the life cycle environmental impacts and the energy payback time (EPBT). Furthermore, 2 electrification options, including a non-site diesel generator system and a grid extension was tested for the environmental performance of the Town Island Microgrid. The EPBT result has resulted in 9.2 years for the microgrid, while the grid extension and the diesel generator EPBT values were 6.4 and 10.1 times longer than that of the microgrid, respectively.

Fan and Xia [80] have presented a building envelope retrofitting via a multi-objective optimization model to select the best use of financial investment for maximizing the energy savings and economic benefits. The main performance indicators for the retrofitting plan have taken the NPV, the payback period and energy savings in the multi-objective optimization problem formulation as a non-linear integer programming problem and solved by a weighted sum method.

Following the above recent study related to payback period assessment, the identified applied formulation that can be

TABLE 5. The payback period formulation from various sources.

Sources	Payback Period Formulation
Chang and Starcher [66]	$P = \frac{I_C - I_n}{A_E * P_E - AOM}$ <p>Abbreviations: I_C =Initial cost of installation. I_n =Value of the national or state incentives. A_E =Annual energy production. P_E =Rate of electricity. AOM = Annual operation and maintenance cost.</p>
Numbi and Malinga [68]	$True\ Payback\ Period = \frac{PW_{TC}}{PW_{TB-av}}$ <p>PW_{TB-av} is the annual average PW_{TB} obtained using equation as below;</p> $PW_{TB-av} = \frac{PW_{TB}}{n}$ <p>Abbreviations: PW_{TC} = Present worth (PW) of total costs n = Project lifetime PW_{TB} = PW of total benefits i.e. which are the annual cost savings less any annual costs discounted to a PW and incurred by the user during operation.</p>
Chel et al. [76]	$Payback\ period = \frac{Embodied\ energy\ (kWh)}{PV\ Energy\ generated\ (kWh/year)}$
San Ong and Thum [61]	$Payback\ period = Year\ before\ full\ recovery + \frac{Unrecovered\ cost\ at\ start\ of\ year}{Cash\ flow\ during\ year}$
Rodrigues et al. [78]	$Simple\ Payback\ period\ (SPBP) = \frac{Initial\ Investment\ (\text{€})}{Annual\ Saving\ (\text{€}/year)}$
Fan and Xia [80]	$T_p = N + \frac{C_{fa}}{C_{fb}}$ <p>Abbreviations: N = the last month with a negative cumulative cash flow, C_{fa} = the absolute value of the cumulative cash flow at the end of the N-th month (\$), C_{fb} = the total cash flow during the (N + 1)-th month (\$)</p>
Hou et al. [77]	$Energy\ Payback\ Time\ (T_{EPBT}) = \frac{Total\ Consumed\ Energy}{Annual\ Output\ Energy}$
Wang et al. [79]	$\frac{EPBT}{year} = \frac{Total\ Primary\ Energy\ Demand}{Annual\ Energy\ Output}$

Critical Evaluation:

The utilization of adjusted factor towards consideration of specific potential line losses and low performance is not considered in the overall formulation

extracted within several of these references is highlighted in Table 5.

To summarize, the above formulations (Table 5) for early estimation purposes do not highlight the utilization of

adjusted factors towards consideration of specific potential line losses and low performance to obtain a more accurate total energy generated figure. The grid condition in deeper insight for total line loss and higher performance have not been discovered yet specifically towards the impact on the payback period calculation. This is important since simultaneous optimization criteria for RE-based DG location and capacity was found to be more effective to be observed via minimal losses outcome [34] and also implemented in many recent kinds of literature [33]–[37], therefore, this has shown a gap for measuring the factor which comprised of line losses outcome and higher performance indicator followed by the payback period assessment to validate its’ potential as previously-briefed.

D. RESEARCH GAP AND CONTRIBUTION OF STUDY

The overall review from the literature had overcome the research gap which focuses on measuring the line losses outcome for improving initial estimation in payback period calculation and introducing ratio of useful consumption yield for load and line loss minimization as part of the input parameter of Y_f in PR formulation.

Thus, the proposed assessment of PV-DG performance offer a new contribution of knowledge as well as justification on the importance of the study which is portrayed in-depth towards achieving a more sensible and transparency outcome especially in the payback period value. This also will encourage the developers, building owners, and users, in participating in achieving potential benefits both in monetary and power system reliability improvement. The contributions of this paper can be summarized as follows:

- Introduce and highlight the existence of the ratio ϕ of useful energy consumption for load and loss minimization from the PV-DG generation and proven its potential in determining the end-result of payback period outcome via proposed assessment.
- Introduced an adjusted factor in obtaining accurate total energy generated in payback period measurement.
- Highlights in-depth explanatory of ϕ which contributes towards the determination of useful energy consumption yield from the PV-DG generated power.
- The desired performance level for PV-DG can be tuned via a downstream-to-upstream approach considering the desired payback period as an initial basis for the upstream parameter.

In specific, this paper introduces a potential factor in the final yield (Y_f) input parameter which significantly improves the PR towards extended version for a more accurate figure.

III. RESEARCH METHOD

The extensiveness of the PR as the overall PV-DG performance indicator is being improvised towards extended version by introducing the ratio ϕ of useful energy consumption for load and loss minimization from the PV-DG generation which includes total line loss minimization outcome as part

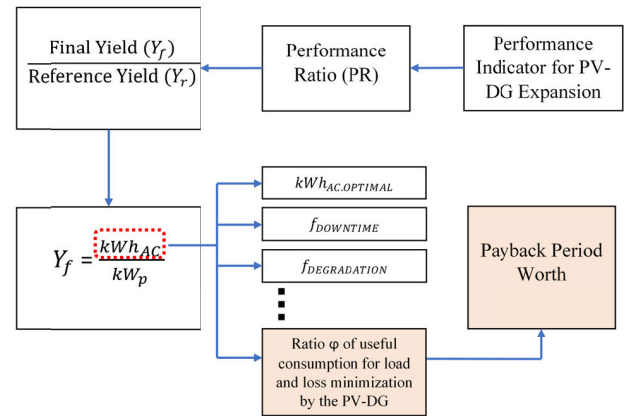

FIGURE 2. Research boundary showing the determinant of the proposed ratio towards payback period worth.

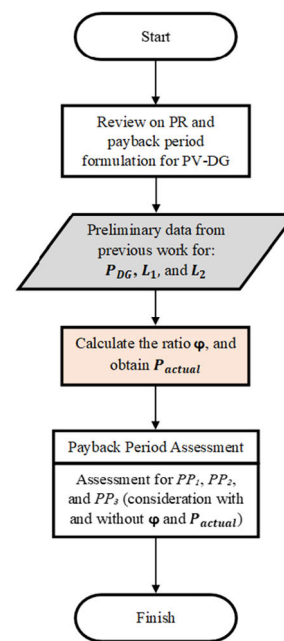

FIGURE 3. Overall flowchart of the study which also consisted of adoption of preliminary data from the previous work.

of an input parameter. This factor is proposed to be considered in PR formulation as an indicator to translate on how well the PV-DG generated power is being transferred along with the AC distribution network for load consumption and loss minimization which also determining the overall performance of PV-DG installation. This also significantly justifies the PV-DG expansion-limit and contributing to the final yield (Y_f) input parameter towards the upper level of accuracy.

The assessment for measuring both PV-DG performance and payback period uses a simulated based-outcome of PV-DG expanding baseline from a previous work by [33] which focused on three selected Malaysian public hospitals’ distribution network. The research boundary for this study is illustrated with orange color in Fig. 2.

The overall flow of this study as illustrated in Fig. 3. All processes are examined for the National level, State level, and

District level hospital according to the previous application for PV-DG expansion-limit assessment. In the first process, a review on the various PR and payback period formulation is performed to identify their significance on the input data which could project a more transparency in both system performance and payback outcome. Then, the preliminary input data is gained from the previous work as discussed above. Consequently, the PR ratio is calculated and the φ and P_{Load} are obtained, and finally, the payback period assessment is performed to validate the potential outcome of the proposed factor.

A. PERFORMANCE MEASURE CONSIDERING PV-DG EXPANSION NEEDS IN GBRS

In this part, the simulation result in [33] is used as the input parameter which comprised of the values as follow:

- The maximum demand (MD) for the three selected distribution networks (National-level hospital (Zone A only), State-level hospital (Zone A only) and district-level hospital (Zone A)).
- The total power supply by substation (P_{base}) and MD (P_{Load}) data.
- PV-DG expanding capacity from 15% of MD through 5% ascending stages up to an optimal point.
- PV-DG expansion-limit and the optimal value.
- Total line loss (TLL) value for all PV-DG values up to the optimal point (expansion-limit).

The detail of the input data for the above parameter is shown in Table 6. This previous work has portrayed the real findings for practical application which also highlights the uniqueness of the solution towards an effective PV-DG outcome for selected public hospitals as compared to other types of buildings. The PV-DG optimization for capacity and location simultaneously has demonstrated a stochastic approach throughout a 50 random search via the Artificial Bee Colony (ABC) algorithm and has partially solved the way forward for PV-DG expansion capacity via NEM scheme in selected public hospitals to a certain limit of effectiveness. This limit provides a beneficial information to the RE developer in obtaining the best option for expanding PV-DG installation via a NEM scheme as well as providing the lowest power loss impact on the existing network. Therefore, the information has an advantage and very useful for practical application.

The input parameter for simulated outcome must fulfill all constraints while striving the main objective to reduce the power losses. This important procedure needs to be observed during the assessment process to ensure violation of any limit is not occur in the solution. Assessment process with all constraints for unlimited and limited capacity as listed below:

- a) Power balance constraint [81]–[83];

$$P_{DG} + P_{base} = P_{Load} + TLL \tag{2}$$

TABLE 6. The detail input data extracted from the simulation result in [33].

Network location	National-level hospital	State-level hospital	District-level hospital
P_{Load} (kW)	1097	1248	1232
P_{base} (kW)	1561	1598	1880
			185 (15% of MD)
			246 (20% of MD)
	165 (15% of MD)	187 (15% of MD)	308 (25% of MD)
	219 (20% of MD)	250 (20% of MD)	370 (30% of MD)
PV-DG	274 (25% of MD)	312 (25% of MD)	431 (35% of MD)
size	329 (30% of MD)	374 (30% of MD)	493 (40% of MD)
(kWp) &	384 (35% of MD)	437 (35% of MD)	554 (45% of MD)
limit/	439 (40% of MD)	499 (40% of MD)	616 (50% of MD)
optimal	494 (45% of MD)	562 (45% of MD)	678 (55% of MD)
	546 (limit /optimal)	624 (50% of MD)	739 (60% of MD)
		654 (limit /optimal)	801 (65% of MD)
			862 (70% of MD)
			885 (limit/ optimal)
Initial Loss, L_1 (kW)	464	350	648
			645
			642
	446	338	511
	389	258	401
	285	195	313
Total Loss, L_2 (kW)	201	146	243
	136	113	193
	89	95	164
	62	82	138
	53	72	99
		70	73
			62
			60

where the summation of the total power supply by substation and power output from the DG must be equal to the total size of load plus total power losses.

- b) The ratio of useful energy consumption for load and loss minimization from the PV-DG generation (%);

To highlight the loss level dependency on penetration, dispersion level, type of DG technology, distribution network characteristics and load demand levels as highlighted by Van Van Thong *et al.* [50], a φ measure of useful consumption for load and loss minimization by the PV-DG generation is being derived where (2) is referred as the basis of the ratio formulation setup. Then, considering the measurement of an output value by input value, the ratio φ can be obtained by (3);

$$\varphi = \frac{P_{Load} + TLL}{P_{Base} + P_{DG}} \tag{3}$$

Thus, φ for solving the power transfer performance of P_{DG} for line loss minimization in the radial distribution network is made using (3) for all cases of study and is graphically plotted to highlight the actual power consumption curve towards total line losses minimization, and the output curve is expected to be in a non-linear form.

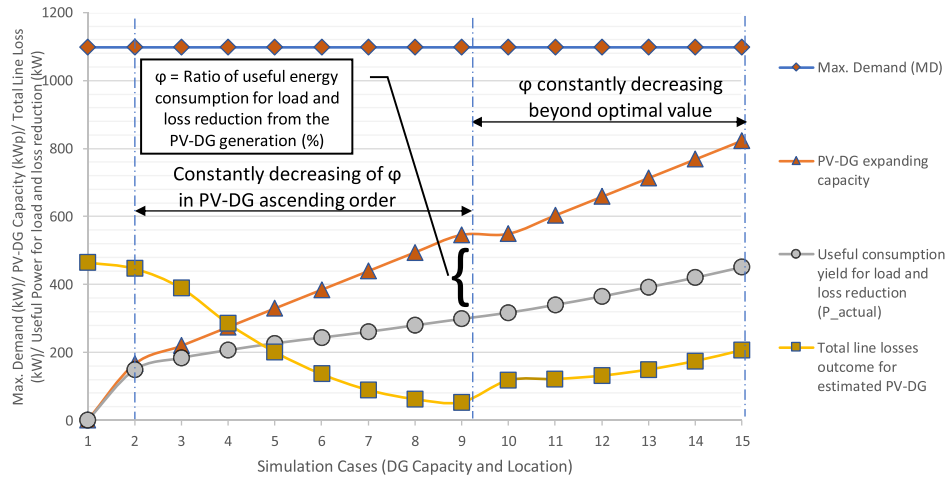

FIGURE 4. The ϕ outcome for National-level hospital (Zone A).

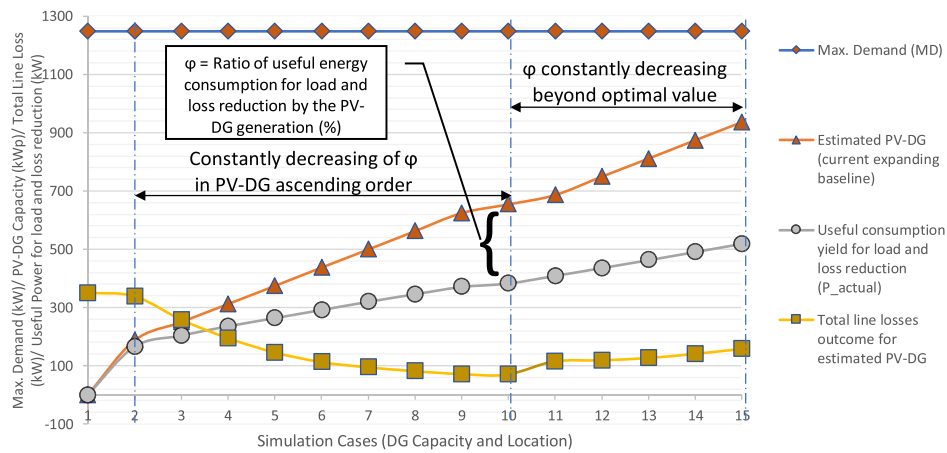

FIGURE 5. The ϕ outcome for State-level hospital (Zone A).

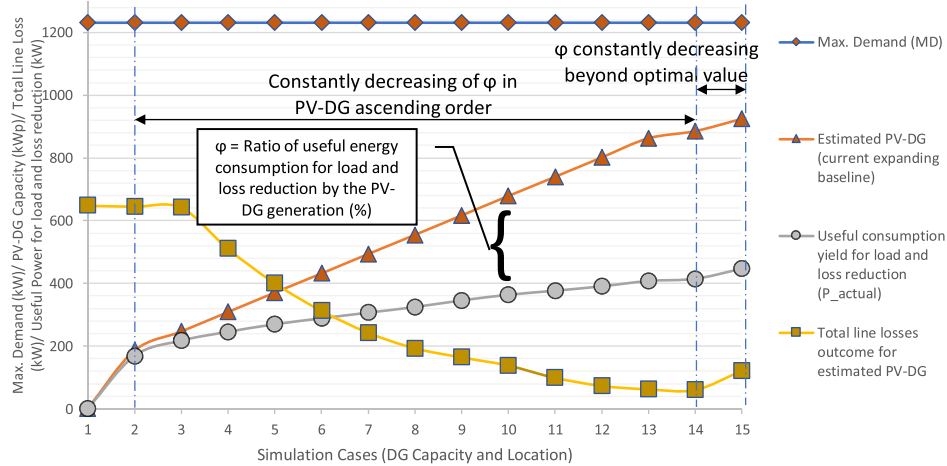

FIGURE 6. The ϕ outcome for District-level hospital.

B. PAYBACK PERIOD ASSESSMENT, COMPARISON AND EXPECTED MINIMIZATION

The advantages of the PV-DG expansion-limit via optimal losses with higher useful consumption yield are

measure towards the payback period impact outcome for CAPEX and OPEX. As such, the assessment for this payback period is highlighted by selecting the most optimal PV-DG capacity including its' total line

TABLE 7. Estimated CAPEX.

1	Preliminaries	1% (RM50.00)
2	Solar Panel	45% (RM2,250)
3	Inverter & Cable	36% (RM1,800)
4	Mounting Structure	9% (RM450)
5	DC & AC Switchboard	7% (RM350)
6	Earthing System	2% (RM100)
Estimated CAPEX		RM5,000 per kWp

TABLE 8. Estimated OPEX.

No	Description	Value
1	Projected OPEX for year 1 (RM)	CAPEX x 1%
2	Projected OPEX for consecutive years (%)	3% per year
3	Major replacement every 10 years	Estimated CAPEX x 36% (inverter and cables)

losses simulated outcome value in accordance with Table 6.

Three sets of payback period assessment worksheet, i.e. PP_1 , PP_2 , and PP_3 , were established which represent all level hospitals, i.e. for National, State, and District-level hospital respectively as according to the simulation result as previous-discussed where these also involved in examining the role of the ratio ϕ towards measuring the payback period implication.

The CAPEX and OPEX for this research adopt the estimated-based values from the database [84] as well as several referral projects related to the PV-DG system implemented by MoH. The rest of the calculation that relates to payback period calculation constitutes estimated CAPEX

TABLE 9. Basic input parameter in payback period calculation.

No	Description	Value
1	Estimated PV-DG capacity (kWp)	P_{DG}
2	Active power of slack bus (kW)	P_{Base}
3	Initial line losses – without PV-DG connection (kW)	L_1
4	Total line losses simulated outcome with PV-DG connection (kW)	L_2
5	The ratio of useful energy consumption for load and loss minimization from the PV-DG generation (%)	$\phi = \frac{P_{Load} + L_2}{P_{Base} + P_{DG}}$
6	The useful energy consumption yield for load and loss minimization (kW)	$P_{actual} = P_{DG} \times \phi$
Estimated Power Generation / Year (kWh)		
i.	via assessment without consideration of ϕ	$P_{DG} \times 3 \text{ Hours} \times 365 \text{ Days}$
ii.	Linear PV-DG expanding baseline, with consideration of ϕ	$P_{actual} \times 3 \text{ Hours} \times 365 \text{ Days}$
8	Estimated CAPEX (RM) for Assessment with and without consideration of ϕ	$P_{DG} \times \text{RM}5,000.00$
9	PV-DG performance drop annually (%)	0.70
10	TNB Tariff B (RM)	0.50
11	TNB Tariff C1 (RM)	0.41
12	TNB Tariff annual increase (%)	4.22
Estimated saving per annum (RM)		
i.	Assessment without consideration of ϕ	Estimated energy generation per year (P_{DG} basis) x TNB tariff C1
ii.	Linear PV-DG expanding baseline, with consideration of ϕ	Estimated energy generation per year (P_{actual} basis) x TNB tariff C1

(Table 7), estimated OPEX (Table 8) and input parameter in payback period calculation (Table 9).

TABLE 10. Table of results for National-level hospital.

National-Level Hospital	Case (PV-DG % from MD)	1	2	3	4	5	6	7	8	9	10	11	12	13	14	15
		-	(15)	(20)	(25)	(30)	(35)	(40)	(45)	(Optimal)	(50)	(55)	(60)	(65)	(70)	(75)
	Optimal PV-DG in kWp (Bus) (MD=1097kW)	-	165 (bus 5)	219 (bus 7)	274 (bus 4)	329 (bus 7)	384 (bus 4)	439 (bus 7)	494 (bus 4)	546 (bus 7)	549 (bus 7)	603 (bus 7)	658 (bus 7)	713 (bus 7)	768 (bus 7)	823 (bus 7)
	Total Line Losses (kW)	464	446	389	285	201	136	89	62	53	117	121	131	149	174	206
	Total loss minimization (%)	-	4%	16%	39%	57%	71%	81%	87%	89%	75%	74%	72%	68%	63%	56%
	Ratio ϕ (%)	-	89%	83%	75%	69%	63%	59%	56%	55%	58%	56%	55%	55%	55%	55%
	P_{actual} (kW)	-	148	183	206	226	243	260	279	298	316	339	364	391	419	450

TABLE 11. Table of results for State-level hospital's distribution network.

State-Level Hospital	Case (PV-DG % from MD)	1	2	3	4	5	6	7	8	9	10	11	12	13	14	15
		-	(15)	(20)	(25)	(30)	(35)	(40)	(45)	(50)	(Optimal)	(55)	(60)	(65)	(70)	(75)
	Optimal PV-DG in kWp (Bus) (MD=1248kW)	-	187 (bus 4)	250 (bus 4)	312 (bus 4)	374 (bus 4)	437 (bus 4)	499 (bus 4)	562 (bus 4)	624 (bus 3)	654 (bus 3)	686 (bus 3)	749 (bus 3)	811 (bus 3)	874 (bus 3)	936 (bus 3)
	Total Line Losses (kW)	350	338	258	195	146	113	95	82	72	70	115	119	127	141	158
	Total loss minimization (%)	-	3%	26%	44%	58%	68%	73%	77%	79%	80%	67%	66%	64%	60%	55%
	Ratio ϕ (%)	-	89%	81%	76%	71%	67%	64%	62%	59%	59%	60%	58%	57%	56%	55%
	P_{actual} (kW)	-	166	204	236	264	292	320	346	371	383	409	436	463	491	519

TABLE 12. Table of results for District-level hospital.

District-Level Hospital	Case	1	2	3	4	5	6	7	8	9	10	11	12	13	14	15
	(PV-DG % from MD)	-	(15)	(20)	(25)	(30)	(35)	(40)	(45)	(50)	(55)	(60)	(65)	(70)	(Optimal)	(75)
	Optimal PV-DG in kWp (Bus)	-	185 (bus 2)	246 (bus 2)	308 (bus 2)	370 (bus 2)	431 (bus 2)	493 (bus 2)	554 (bus 2)	616 (bus 2)	678 (bus 5)	739 (bus 5)	801 (bus 5)	862 (bus 5)	885 (bus 5)	924 (bus 5)
	Total Line Losses (kW)	648	645	642	511	401	313	243	193	164	138	99	73	62	60	121
	Total loss minimization (%)	-	0.5%	1%	21%	38%	52%	63%	70%	75%	79%	85%	89%	90%	91%	81%
	Ratio ϕ (%)	-	91%	88%	80%	73%	67%	62%	59%	56%	54%	51%	49%	47%	47%	48%
	P_{actual} (kW)	-	168	217	245	269	288	306	324	345	363	376	390	407	414	446

TABLE 13. The obtained input parameter for PP_1 , PP_2 , and PP_3 .

No	Description	Value
1	Estimated PV-DG capacity (kWp)	$PP_1 = 546$ $PP_2 = 654$ $PP_3 = 885$
2	Active power of slack bus, P_{Base} (kW)	$PP_1 = 1,097$ $PP_2 = 1,248$ $PP_3 = 1,232$
3	Initial line losses, L_1 – without PV-DG connection (kW)	$PP_1 = 464$ $PP_2 = 350$ $PP_3 = 648$
4	Total line losses (L_2) simulated outcome with PV-DG connection (kW)	$PP_1 = 53$ $PP_2 = 70$ $PP_3 = 60$
5	The ratio ϕ of useful energy consumption for load and loss minimization by PV-DG generation (%)	$PP_1 = 55\%$ $PP_2 = 59\%$ $PP_3 = 47\%$
6	The useful energy consumption yield for load and loss minimization (kW)	$PP_1 = 298$ $PP_2 = 383$ $PP_3 = 414$
7	Estimated Power Generation / Year (kWh)	
i	via assessment without consideration of ϕ	$PP_1 = 597,870$ $PP_2 = 716,130$ $PP_3 = 969,075$
ii	Linear PV-DG expanding baseline, with consideration of ϕ	$PP_1 = 326,317.28$ $PP_2 = 419,120.49$ $PP_3 = 452,819.13$
8	Estimated CAPEX (RM) for Assessment with and without consideration of ϕ	$PP_1 = 2,730,000.00$ $PP_2 = 3,270,000.00$ $PP_3 = 4,425,000.00$
9	PV performance drop (%) annually	0.70
10	TNB Tariff B (RM)	0.50
11	TNB Tariff C1 (RM)	0.41
12	TNB Tariff annual increase (%)	4.22
13	Estimated saving per annum (RM)	
i	Assessment without consideration of ϕ	$PP_1 = 245,126.70$ $PP_2 = 293,613.30$ $PP_3 = 397,320.75$
ii	Linear PV-DG expanding baseline, with consideration of ϕ	$PP_1 = 133,790.08$ $PP_2 = 171,839.40$ $PP_3 = 185,655.84$

IV. RESULT AND DISCUSSIONS

The assessment is performed accordingly and the ϕ values followed by the P_{actual} results are obtained and compiled in Table 10, Table 11, and Table 12. Representing outcomes for National-level (Zone A), State-level (Zone A) and District-level hospital (Zone A) respectively including the previous input data of P_{DG} , L_1 , and L_2 .

A. PERFORMANCE OUTCOME IN PV-DG EXPANSION FOR NATIONAL-LEVEL, STATE-LEVEL AND DISTRICT-LEVEL HOSPITAL

From the previous work which summarized in Table 6, the obtained P_{DG} , L_1 and L_2 have given access to measure the ratio ϕ of useful energy consumption for load and loss minimization from the PV-DG generation which also represented by (3). Apparently, this also obtained P_{actual} as a product of useful energy consumption yield for load and loss minimization multiplication outcome. For National-level hospital (Zone A), the percentage of ϕ are equivalent to 89%, 83%, 75%, 69%, 63%, 59% and 56% for PV-DG with capacity of 15% of MD to 45% of MD in 5% ascending sequence respectively. While, ϕ for the optimal case is equivalent to 55% and beyond this optimal value, ϕ continue to decrease with value of 58%, 56%, 55%, 55%, 55% and 55% for PV-DG with a capacity of 50% of MD to 75% of MD in 5% ascending sequence respectively. These ϕ values are as highlighted with color in Table 10.

Subsequently, ϕ is measured via (3) for State-level hospital which obtained P_{actual} as a product of useful energy consumption yield for load and loss minimization multiplication outcome. For Zone A, the percentage of ϕ are equivalent to 89%, 81%, 76%, 71%, 67%, 64%, 62% and 59% for PV-DG with capacity of 15% of MD to 50% of MD in 5% ascending sequence respectively. While, ϕ for the optimal case is equivalent to 59% and beyond this optimal value, ϕ continue to decrease with the value of 60%, 58%, 57%, 56% and 55% for PV-DG with a capacity of 55% of MD to 75% of MD in 5% ascending sequence respectively. These ϕ values are as highlighted with color in Table 11.

Lastly, for the District-level hospital’s distribution network, ϕ is measured via (3) which obtained P_{actual} as a product of useful energy consumption yield for load and loss minimization outcome. The percentage of ϕ are equivalent to 91%, 88%, 80%, 73%, 67%, 62%, 59%, 56%, 54%, 51%, 49% and 47% for PV-DG with capacity of 15% of MD to 70% of MD in 5% ascending sequence respectively. While, ϕ for the optimal case is equivalent to 47% and beyond this optimal value, ϕ is equal to 48% for PV-DG with 75% from MD. These ϕ values are as highlighted with color in Table 12.

TABLE 14. The payback period worksheet for PP_1 .

PAYBACK PERIOD CALCULATION (WITHOUT RATIO ϕ CONSIDERATION)	Year	PV-DG Capacity (kWp)	Net Estimated Power Generation / Year (kWh)	Estimated Saving / Year (TNB Tariff = C1)	OPEX / Year		Net Yearly Saving (Project)	Net Accumulated Saving	Payback Period
					Minor Replacement	Major Replacement			
	2017	0	N/A	N/A	N/A	N/A	N/A	N/A	
	2018	1	546	597,870.00	RM 245,126.70	RM (27,300.00)	-	RM 217,826.70	217,826.70
	2019	2	542.18	593,684.91	RM 255,471.05	RM (28,119.00)	-	RM 227,352.05	445,178.75
					----- Hide Row -----				
	2027	10	512.55	561,241.79	RM 355,590.57	RM (35,620.31)	RM (982,800.00)	RM(662,829.74)	1,677,453.97
	2028	11	508.96	557,313.09	RM 370,596.49	RM (36,688.92)	-	RM 333,907.58	2,011,361.55
	2029	12	505.40	553,411.90	RM 386,235.67	RM (37,789.58)	-	RM 348,446.08	2,359,807.63
	2030	13	501.86	549,538.02	RM 402,534.81	RM (38,923.27)	-	RM 363,611.54	2,723,419.17
	2031	14	498.35	545,691.25	RM 419,521.78	RM (40,090.97)	-	RM 379,430.81	3,102,849.98
									√
PAYBACK PERIOD CALCULATION (WITH RATIO ϕ CONSIDERATION)	Year	P_{actual} (kW)	Net Estimated Power Generation / Year (kWh)	Estimated Saving / Year (TNB Tariff = C1)	OPEX / Year		Net Yearly Saving (Project)	Net Accumulated Saving	Payback Period
					Minor Replacement	Major Replacement			
	2017	0	N/A	N/A	N/A	N/A	N/A	N/A	
	2018	1	298	326,317.28	RM 133,790.08	RM (27,300.00)	-	RM 106,490.08	106,490.08
	2019	2	295.92	324,033.05	RM 139,436.02	RM (28,119.00)	-	RM 111,317.02	217,807.11
					----- Hide Row -----				
	2026	9	281.72	308,485.00	RM 186,222.64	RM (34,582.82)	-	RM 151,639.81	1,151,356.64
	2027	10	279.75	306,325.61	RM 194,081.23	RM (35,620.31)	RM (982,800.00)	RM(824,339.07)	327,017.57
	2028	11	277.79	304,181.33	RM 202,271.46	RM (36,688.92)	-	RM 165,582.54	492,600.11
					----- Hide Row -----				
	2037	20	260.77	285,545.81	RM 293,423.05	RM (47,870.72)	RM (982,800.00)	RM(737,247.66)	1,377,033.62
	2038	21	258.95	283,546.99	RM 305,805.51	RM (49,306.84)	-	RM 256,498.67	1,633,532.29
					----- Hide Row -----				
	2042	25	251.77	275,690.65	RM 360,785.92	RM (55,495.28)	-	RM 305,290.64	2,778,896.17
									√

TABLE 15. The payback period worksheet for PP_2 .

PAYBACK PERIOD CALCULATION (WITHOUT RATIO ϕ CONSIDERATION)	Year	PV-DG Capacity (kWp)	Net Estimated Power Generation / Year (kWh)	Estimated Saving / Year (TNB Tariff = C1)	OPEX / Year		Net Yearly Saving (Project)	Net Accumulated Saving (Project)	Payback Period
					Maintenance / Minor Replacement	Maintenance / Major Replacement			
	2017	0	N/A	N/A	N/A	N/A	N/A	N/A	
	2018	1	654.00	716,130.00	RM 293,613.30	RM (32,700.00)	-	RM 260,913.30	260,913.30
	2019	2	649.42	711,117.09	RM 306,003.78	RM (33,681.00)	-	RM 272,322.78	533,236.08
					----- Hide Row -----				
	2027	10	613.93	672,256.65	RM 425,927.17	RM (42,666.08)	RM (1,177,200.00)	RM (793,938.91)	2,009,258.06
	2028	11	609.64	667,550.85	RM 443,901.30	RM (43,946.07)	-	RM 399,955.23	2,409,213.28
	2029	12	605.37	662,877.99	RM 462,633.93	RM (45,264.45)	-	RM 417,369.48	2,826,582.77
	2030	13	601.13	658,237.85	RM 482,157.08	RM (46,622.38)	-	RM 435,534.70	3,262,117.47
	2031	14	596.92	653,630.18	RM 502,504.11	RM (48,021.05)	-	RM 454,483.06	3,716,600.53
									√
PAYBACK PERIOD CALCULATION (WITH RATIO ϕ CONSIDERATION)	Year	P_{actual} (kW)	Net Estimated Power Generation / Year (kWh)	Estimated Saving / Year (TNB Tariff = C1)	OPEX / Year		Net Yearly Saving (Project)	Net Accumulated Saving (Project)	Payback Period
					Maintenance / Minor Replacement	Maintenance / Major Replacement			
	2017	0	N/A	N/A	N/A	N/A	N/A	N/A	
	2018	1	382.76	419,120.49	RM 171,839.40	RM (32,700.00)	-	RM 139,139.40	139,139.40
	2019	2	380.08	416,186.65	RM 179,091.02	RM (33,681.00)	-	RM 145,410.02	284,549.42
					----- Hide Row -----				
	2027	10	359.31	393,443.28	RM 249,277.09	RM (42,666.08)	RM (1,177,200.00)	RM (970,588.99)	532,224.60
	2028	11	356.79	390,689.17	RM 259,796.58	RM (43,946.07)	-	RM 215,850.52	748,075.12
	2029	12	354.30	387,954.35	RM 270,760.00	RM (45,264.45)	-	RM 225,495.55	973,570.67
					----- Hide Row -----				
	2037	20	334.93	366,753.79	RM 376,871.29	RM (57,339.65)	RM (1,177,200.00)	RM (857,668.36)	2,002,385.67
	2038	21	332.59	364,186.52	RM 392,775.26	RM (59,059.84)	-	RM 333,715.42	2,336,101.09
					----- Hide Row -----				
	2041	24	325.65	356,592.01	RM 444,628.54	RM (64,536.28)	-	RM 380,092.26	3,428,680.47
									√

B. IN-DEPTH EXPLANATORY FOR ϕ FINDING

For all hospital levels, the preliminary data from previous results (i.e. L_2 , P_{DG} , ϕ and P_{actual}) are needed in graphical

plotting to portray their conditions in a system network. Thus, the analysis of the overall results can be well explained as in Figs. 4 to 6 which focuses on the explanatory of the ϕ as

TABLE 16. The payback period worksheet for PP₃.

	Year	PV-DG Capacity (kWp)	Net		OPEX / Year		Net Yearly Saving (Project)	Net Accumulated Saving (Project)	Payback Period		
			Estimated Power Generation / Year (kWh)	Estimated Saving / Year (TNB Tariff = C1)	Maintenance / Minor Replacement	Maintenance / Major Replacement					
PAYBACK PERIOD CALCULATION (WITHOUT RATIO ϕ CONSIDERATION)	2017	0	N/A	N/A	N/A	N/A	N/A	N/A			
	2018	1	885	969,075.00	RM 397,320.75	RM (44,250.00)	-	RM 353,070.75	353,070.75		
	2019	2	878.81	962,291.48	RM 414,087.69	RM (45,577.50)	-	RM 368,510.19	721,580.94		
	----- Hide Row -----										
	2027	10	830.78	909,705.09	RM 576,369.33	RM (57,736.21)	RM(1,593,000.00)	RM(1,074,366.88)	2,718,950.12		
	2028	11	824.97	903,337.16	RM 600,692.12	RM (59,468.30)	-	RM 541,223.82	3,260,173.94		
	2029	12	819.19	897,013.80	RM 626,041.33	RM (61,252.35)	-	RM 564,788.98	3,824,962.92		
	2030	13	813.46	890,734.70	RM 652,460.27	RM (63,089.92)	-	RM 589,370.35	4,414,333.27		
	2031	14	807.76	884,499.56	RM 679,994.10	RM (64,982.62)	-	RM 615,011.48	5,029,344.75	√	
	PAYBACK PERIOD CALCULATION (WITH RATIO ϕ CONSIDERATION)	2017	0	N/A	N/A	N/A	N/A	N/A	N/A		
		2018	1	413.53	452,819.13	RM 185,655.84	RM (44,250.00)	-	RM 141,405.84	141,405.84	
		2019	2	410.64	449,649.40	RM 193,490.52	RM (45,577.50)	-	RM 147,913.02	289,318.86	
		----- Hide Row -----									
		2027	10	388.20	425,077.39	RM 269,319.78	RM (57,736.21)	RM(1,593,000.00)	RM(1,381,416.44)	151,600.74	
2028		11	385.48	422,101.85	RM 280,685.07	RM (59,468.30)	-	RM 221,216.77	372,817.51		
2029		12	382.78	419,147.13	RM 292,529.98	RM (61,252.35)	-	RM 231,277.63	604,095.14		
----- Hide Row -----											
2037		20	361.86	396,241.98	RM 407,172.96	RM (77,592.64)	RM(1,593,000.00)	RM(1,263,419.68)	1,281,379.72		
2038		21	359.33	393,468.29	RM 424,355.66	RM (79,920.42)	-	RM 344,435.24	1,625,814.96		
----- Hide Row -----											
2045		28	342.09	374,588.53	RM 566,744.72	RM (98,292.04)	-	RM 468,452.68	4,511,593.49	√	

a key factor towards a more transparency in indicates performance which also potentially affects the payback period outcome. Furthermore, it is observed that, upon an increase of PV-DG capacity in the linear baseline, the useful energy consumption yield for load and loss minimization (P_{actual}) found to be underutilized and introduced a constant dropping of ratio ϕ (i.e. forming a wider gap between estimated PV-DG expanding baseline and P_{actual}). Hence, this has indicated lowering performance through a continuous PV-DG expanding utilization within the selected three distribution networks. The validation of the ϕ and P_{actual} effect on the payback period outcome is examined through detailed assessment in later discussion.

C. PAYBACK PERIOD MEASURE AS ACCORDANCE TO THE PV-DG PERFORMANCE OUTCOME

A few parameters on input variables were made into fixed values in defining the overall payback period for CAPEX and OPEX so that the focus of the outcome can be portrayed on the role of ϕ in enabling the length of the period. Some of these fixed parameters were adopted from the common-practices in estimation by the GBRS and PV-DG developers in Malaysia as follows;

- PV-DG installed capacity is set at identified expansion-limit (i.e., at an optimal point);
- PV-DG is assumed to generate a constant output power without intermittency;

TABLE 17. Comparison of payback period assessment between with and without proposed ratio consideration.

Case	ϕ (%)	Payback period without consideration of ϕ (Year)	Payback period with consideration of ϕ (Year)
PP ₁	55	14	25
PP ₂	59	14	24
PP ₃	47	14	28

- PV-DG is assumed to generate maximum full-capacity power in 3 hours per day;
- CAPEX is estimated at RM5,000.00 per kWp basis;
- The values P_{actual} were obtained which represent a product of multiplication outcome between P_{DG} and ϕ as shown in Table 13.

Three sets of payback period assessment worksheets, i.e. PP₁, PP₂, and PP₃ are established for National, State and District-level hospital’s distribution networks respectively which involved in examining the role of the ratio ϕ towards measuring the payback period implication. In contrast, PP₁, PP₂, and PP₃ are determined as below;

- PP₁ – represented by payback period calculation **without** consideration of ratio ϕ versus payback period calculation **with** consideration of ϕ for National-level hospital (Zone A);
- PP₂ – represented by payback period calculation **without** consideration of ratio ϕ versus payback period

TABLE 18. The proposed PR for an extended version.

Sources	Current PR Formula	Proposed PR for an extended version
Haerberlin and Beutler [57]	$PR = \frac{Y_f}{Y_r} = K_T \times K_G \times n_j$	$PR = \frac{Y_f}{Y_r} = K_T \times K_G \times n_j \times \varphi$
	<p>Abbreviations: K_T=Temperature correction factor, K_G=Generation correction factor, n_j=Inverter efficiency φ = ratio of useful energy consumption for load and line loss minimization</p>	
Kymakis et al. [58]	$R_p = \frac{Y_f}{Y_r}$ $R_p = \eta_{deg} \times \eta_{tem} \times \eta_{soil} \times \eta_{net} \times \eta_{inv} \times \eta_{Tran} \times \eta_{ppc}$	$R_p = \frac{Y_f}{Y_r}$ $R_p = \eta_{deg} \times \eta_{tem} \times \eta_{soil} \times \eta_{net} \times \eta_{inv} \times \eta_{Tran} \times \eta_{ppc} \times \varphi$
	<p>Abbreviations: η_{deg}=panel degradation loss, η_{tem}=temp loss, η_{soil}=soiling loss, η_{net}=DC wiring and interconnection loss, η_{inv}=inverter loss, η_{Tran}=transformer loss, η_{ppc}=availability and grid connection loss of the PV plant, $\eta \varphi$ = ratio of useful energy consumption for load and line loss minimization</p>	
Ransome et al. [59]	$PR = \frac{Y_f}{Y_r} = \frac{kWh_{AC}}{kW_p}$ $kWh_{AC} = kWh_{AC.OPTIMAL} \times \frac{insolation\ yearly}{insolation\ nominal} \times f_{DOWNTIME} \times f_{DEGRADATION} \times f_{DIRT} \times f_{SEASONAL} \times f_{SHADING} \times f_{BOS}$	$PR = \frac{Y_f}{Y_r} = \frac{kWh_{AC}}{kW_p}$ $kWh_{AC} = kWh_{AC.OPTIMAL} \times \frac{insolation\ yearly}{insolation\ nominal} \times f_{DOWNTIME} \times f_{DEGRADATION} \times f_{DIRT} \times f_{SEASONAL} \times f_{SHADING} \times f_{BOS} \times f\varphi$
	<p>Abbreviations: f=uncertainty function due to downtime, panel degradation, soiling, seasonal change, shading, balance of system effects, reference module calibration, flash effect, module binning and manufacturer declaration of the PV plant $f\varphi$ = ratio of useful energy consumption for load and line loss minimization</p>	
PR-FACT Mack and Decker GmbH	$PR = f_0 \times f_1 \times f_2 \dots f_{10}$	$PR = f_0 \times f_1 \times f_2 \dots f_{10} \times f_{11}$
	<p>Abbreviations: $f_0, f_1, f_2 \dots f_{10}$= correction factors related to: f_1 and f_2 – plane of angle irradiation; f_2 and f_3 – shading; f_3 and f_4 – PV module; f_5 and f_6 – PV module configuration and DC wiring; f_8, f_9 and f_{10} – AC wiring and transformer of the PV plant. f_{11}= Useful energy consumption for load and line loss minimization</p>	

calculation **with** consideration of φ for State-level hospital (Zone A);

- PP_3 – represented by payback period calculation **without** consideration of ratio φ versus payback period calculation **with** consideration of φ for District-level hospital (Zone A);

Moreover, the estimated CAPEX and OPEX are listed in Table 7 and Table 8 respectively. The obtained input parameter values for PP_1 , PP_2 , and PP_3 are shown in Table 13.

The payback period worksheet for PP_1 , PP_2 , and PP_3 was assessed and the final result is as shown in Table 14, Table 15 and Table 16 respectively. **Without consideration** of φ , the achieved payback period outcome for PV-DG installation is equal to the 14th year for both PP_1 , PP_2 , and PP_3 , regardless of differences in PV-DG capacity value that being utilized and also regardless of differences in the extensiveness of radial distribution network. In other words, the estimation for 546 kWp, 654 kWp, and 845 kWp through PP_1 , PP_2 , and PP_3 cases respectively had resulted in the same payback

period for CAPEX and OPEX if φ is not factored in the calculation.

On the other hand, the assessment **with consideration** of φ has revealed the actual payback period milestone as in PP_1 , PP_2 , and PP_3 where their outcomes are made comparable with the previous *unconsidered* φ based findings. The comparison result showed that the actual payback period for PP_1 , PP_2 , and PP_3 is equivalent to 25 years, 24 years and 28 years for PV-DG installation respectively. Table 17 summarized the comparison result. In addition, the differences of findings were driven by the differences of obtained input parameters as highlighted with the red-dotted line in Tables 14 to 15.

Through the discrepancy of estimated payback period outcome within PP_1 , PP_2 , and PP_3 , the results confirmed the role and the importance in considering the φ based findings in determining the more transparency figure for the payback period milestone (CAPEX and OPEX) which had more advantage in the application as compared with the other way approach of estimation. In contrast, the presented ratio φ of 55%, 59%, and 47% had portrayed the more accurate

payback period outcome, i.e. 25 years, 24 years and 28 years respectively as compared to 14 years via the other way approach of estimation without ϕ consideration.

The findings in the previous work [33], has highlighted the optimal value which depends on the overall performance of PV-DG integration in forming a bidirectional of P into these distribution networks as highlighted in [85]. Similarly, the same reason can relate with the payback period outcome since the determination of the ratio values was driven by the line loss input determined by the type and extensiveness of the radial distributed network in terms of R/X value as referred to Box [86], also the P and Q load data in accordance to Van Thong *et al.* [50] and Bawan [87].

D. PROPOSED ADDITIONAL VALUE TO THE CURRENT PR FORMULATION TOWARDS EXTENDED VERSION

Due to prudence used in the sample selection and data analysis, the PV-DG performance indicator via the ratio ϕ in obtaining the P_{actual} has shown the proportionate contribution to the milestone of the overall payback period through assessment via three selected distribution networks. On the other hand, the IEC 61724 determination on the complete PV-DG system as of Fig. 1 which focuses on the voltage V_L and current I_L towards load consumption [47], has highlighted the needs of the proposed ratio in filling the gaps for precision performance indicator as previous-discussed. Therefore, a performance measure for a complete PV-DG system via PR formulation shall consider the specific total line losses contribution, through the formed of the ratio ϕ as shown in Table 18 where a few selected formulations from the PR review of Table 4 is proposed to be revolutionized for an extended version.

V. CONCLUSION

The previous work in [33] via total line losses measure had successfully portrayed the PV-DG expansion-limit due to the need for increasing the current PV-DG capacity beyond the GBRS base case. In this study, the conducted assessment on the selected PV-DG capacity has introduced the additional effective parameter on top of the loss minimization contribution, i.e. the performance measure tailored for distribution network from selected Malaysian public hospital.

The proposed ϕ value has been tested and highlighted in the previous assessment which has projected the more transparent payback period outcome for the CAPEX and OPEX. Moreover, this also significantly enabling a potential gap for future assessment towards further improvement in P_{DG} capacity setting for higher ϕ achievement. The assessment through PP_1 , PP_2 , and PP_3 had overcome with the final result as shown in Table 14, Table 15, and Table 16 respectively which zooming on the role of ϕ as an enabler towards the payback period achievement is legitimate which proven by the calculation in the worksheet. In contrast, the presence of ϕ in the linear PV-DG expanding approach at the optimal point had clarified the actual payback period, i.e. 25 years, 24 years and

28 years respectively which overwrite the 14 years outcome via the other way approach of estimation without ϕ consideration. Finally, the payback period for CAPEX and OPEX is an important milestone in many Government Agencies due to their designated budget allocation and collection through dedicated 5 years in each of Malaysia Plan periods. The monetary account planning in this sense by MoH for PV-DG design and installation at the selected public hospital can be well-adjusted as according to the desired payback period since time is of constraint and inevitable in the project management. Therefore, the desired performance specification in the form of PR can later be adjusted to suit the timeline and payback period given via a downstream-to-upstream method for a well-justified outlook and workable for practical application by MoH.

Despite due prudence used in the sample selection and data analysis, this paper still has some limitations, i.e. in-depth financial analysis other than the one that has been provided in this research is not considered in the payback period assessment and the PR proposal. Other than that, the input parameter from previous work was also limited by the use of a quantitative approach since the simulation of the technical data role as the main part of the study. However, qualitative analysis to measure the significance of the PV-DG expansion in GBRS may provide different results. The combination of both quantitative and qualitative measures may also provide a wider contribution in terms of the significant improvement in GBRS tools.

REFERENCES

- [1] B. Lin and M. Xu, "Regional differences on CO₂ emission efficiency in metallurgical industry of China," *Energy Policy*, vol. 120, pp. 302–311, Sep. 2018.
- [2] F. N. G. Andersson, S. Opper, and U. Khalid, "Are capitalists green? Firm ownership and provincial CO emissions in China," *Energy Policy*, vol. 123, pp. 349–359, Dec. 2018.
- [3] P. K. Adom, P. A. Kwakwa, and A. Amankwaa, "The long-run effects of economic, demographic, and political indices on actual and potential CO₂ emissions," *J. Environ. Manage.*, vol. 218, pp. 516–526, Jul. 2018.
- [4] M. A. Dulebenets, "Advantages and disadvantages from enforcing emission restrictions within emission control areas," *Maritime Bus. Rev.*, vol. 1, no. 2, pp. 107–132, Jun. 2016.
- [5] O. F. Abioye, M. A. Dulebenets, J. Pasha, and M. Kavosi, "A vessel schedule recovery problem at the liner shipping route with emission control areas," *Energies*, vol. 12, no. 12, p. 2380, Jun. 2019.
- [6] M. A. Dulebenets, "The green vessel scheduling problem with transit time requirements in a liner shipping route with emission control areas," *Alexandria Eng. J.*, vol. 57, no. 1, pp. 331–342, Mar. 2018.
- [7] P. L. Lo, G. Martini, F. Porta, and D. Scotti, "The determinants of CO₂ emissions of air transport passenger traffic: An analysis of lombardy (Italy)," *Transp. Policy*, vol. 91, pp. 108–119, Jun. 2020.
- [8] J. I. Mikayilov, M. Galeotti, and F. J. Hasanov, "The impact of economic growth on CO₂ emissions in azerbaijan," *J. Cleaner Prod.*, vol. 197, pp. 1558–1572, Oct. 2018.
- [9] H.-T. Pao, H.-C. Yu, and Y.-H. Yang, "Modeling the CO₂ emissions, energy use, and economic growth in Russia," *Energy*, vol. 36, no. 8, pp. 5094–5100, Aug. 2011.
- [10] N. Yavuz, "CO₂ emission, energy consumption, and economic growth for Turkey: Evidence from a cointegration test with a structural break," *Energy Sources, B, Econ., Planning, Policy*, vol. 9, no. 3, pp. 229–235, 2014.
- [11] V. Esteve and C. Tamarit, "Threshold cointegration and nonlinear adjustment between CO₂ and income: The environmental Kuznets curve in Spain, 1857–2007," *Energy Econ.*, vol. 34, no. 6, pp. 2148–2156, Nov. 2012.

- [12] H. Iwata, K. Okada, and S. Samreth, "Empirical study on the environmental Kuznets curve for CO₂ in France: The role of nuclear energy," *Energy Policy*, vol. 38, no. 8, pp. 4057–4063, Aug. 2010.
- [13] M. Hamit-Haggar, "Greenhouse gas emissions, energy consumption and economic growth: A panel cointegration analysis from Canadian industrial sector perspective," *Energy Econ.*, vol. 34, no. 1, pp. 358–364, Jan. 2012.
- [14] L. Du, C. Wei, and S. Cai, "Economic development and carbon dioxide emissions in China: Provincial panel data analysis," *China Econ. Rev.*, vol. 23, no. 2, pp. 371–384, Jun. 2012.
- [15] A. K. Tiwari, M. Shahbaz, and Q. M. A. Hye, "The environmental Kuznets curve and the role of coal consumption in India: Cointegration and causality analysis in an open economy," *Renew. Sustain. Energy Rev.*, vol. 18, pp. 519–527, Feb. 2013.
- [16] O. A. Onafowora and O. Owoye, "Bounds testing approach to analysis of the environment Kuznets curve hypothesis," *Energy Econ.*, vol. 44, pp. 47–62, Jul. 2014.
- [17] *Eleventh Malaysia Plan, 2016–2020: Anchoring Growth on People, in Malaysia: Prime Minister's Department*, EPU, Percetakan Nasional Malaysia Berhad, Kuala Lumpur, Malaysia, 2015.
- [18] S. Moghimi, "Building energy index (BEI) in large scale hospital: Case study of Malaysia," in *Proc. 4th WSEAS Int. Conf. Recent Res. Geogr. Geol., Energy, Environ. Biomed.*, Corfu Island, Greece, 2011, pp. 167–170.
- [19] J. O. Petinrin and M. Shaaban, "Renewable energy for continuous energy sustainability in malaysia," *Renew. Sustain. Energy Rev.*, vol. 50, pp. 967–981, Oct. 2015.
- [20] H. Hashim and W. S. Ho, "Renewable energy policies and initiatives for a sustainable energy future in malaysia," *Renew. Sustain. Energy Rev.*, vol. 15, no. 9, pp. 4780–4787, Dec. 2011.
- [21] (2019). *Initiatives. Ministry of Energy, Science, Technology, Environment & Climate Change (MESTECC) Initiatives 2019 on Renewable Energy (RE) Quota*. Accessed: Jan. 15, 2019. [Online]. Available: <https://www.mestecc.gov.my/web/wp-content/uploads/2019/01/MESTECC-Initiatives-2019-pg2-pg6-2.pdf>
- [22] (2019). *RE, P. National Renewable Energy Policy*. Accessed: May 9, 2019. [Online]. Available: <http://www.seda.gov.my/policies/national-renewable-energy-policy-and-action-plan-2009/>
- [23] MESTECC. (2019). *Ministry of Energy, Science, Technology, Environment & Climate Change (MESTECC) Initiatives 2019 on Renewable Energy (RE) Policy*. Accessed: Jun. 3, 2019. [Online]. Available: http://inisiatif.mestecc.gov.my/homepage_ms.html
- [24] M. E. Amran, M. N. Muhtazaruddin, N. A. Bani, S. A. S. A. Rahaman, N. M. Yusoff, M. H. Azizul, and F. Muhammad-Sukki, "Photovoltaic-integrated review and expansion need in green building landscape for bridging the Malaysian RE policy," *Indonesian J. Electr. Eng. Comput. Sci.*, vol. 17, no. 1, p. 27, Jan. 2020.
- [25] GreenMark. (2015). *Building and Construction Authority (BCA) Green Mark for Existing Non-Residential Buildings (GM ENRB: 2015)*. Accessed: Jan. 2, 2019. [Online]. Available: https://www.bca.gov.sg/GreenMark/green_mark_criteria.html
- [26] GreenRE. (2018). *GreenRE for Existing Non-Residential Building (ENRB V3.1)*. Accessed: May 9, 2019. [Online]. Available: <https://greenre.org/rating-tools.html>
- [27] Greenship. (2011). *G. Greenship for Existing Building: Benchmark Summary. Green Building Council Indonesia, Jakarta, Indonesia*. Accessed: Feb. 3, 2019. [Online]. Available: <http://www.gbciindonesia.org/greenship/rating-tools/summary>
- [28] GBI. (2013). *Green Building Index for Non-Residential Existing Building (NREB): Hospital*. Accessed: May 9, 2019. [Online]. Available: <https://new.greenbuildingindex.org/tools>
- [29] MyCREST. (2015). *C. Malaysian Carbon Reduction & Environmental Sustainability Tool—Operation and Maintenance Stage*. Accessed: May 9, 2019. [Online]. Available: <http://www.cidb.gov.my/index.php/en/focus-areas/sustainable-construction>
- [30] TREES. (2017). *Thai's Rating of Energy and Environmental Sustainability for Existing Building (TREES-EB): Operation and Maintenance*. Accessed: May 9, 2019. [Online]. Available: <http://www.tgbi.or.th/tag/show/4>
- [31] R. Rahardjati, M. F. Khamidi, and A. Idrus, "The level of importance of criteria and sub criteria in green building index Malaysia," in *Proc. Int. Conf. Sustain. Building Infrastruct. (ICSBI)*. Kuala Lumpur, Malaysia: Kuala Lumpur Convention Centre, 2010, pp. 1–6.
- [32] LEED. (2016). *U.v. LEED v4 for Building Operations and Maintenance*. Accessed: Jan. 3, 2019. [Online]. Available: <https://www.usgbc.org/resources/leed-v4-building-operations-and-maintenance-current-version>
- [33] M. E. Amran, M. N. Muhtazaruddin, F. Muhammad-Sukki, N. A. Bani, T. Z. Ahmad Zaidi, K. A. Kamaluddin, and J. A. Ardila-Rey, "Photovoltaic expansion-limit through a net energy metering scheme for selected Malaysian public hospitals," *Sustainability*, vol. 11, no. 18, p. 5131, Sep. 2019.
- [34] T. T. Nguyen, A. V. Truong, and T. A. Phung, "A novel method based on adaptive cuckoo search for optimal network reconfiguration and distributed generation allocation in distribution network," *Int. J. Electr. Power Energy Syst.*, vol. 78, pp. 801–815, Jun. 2016.
- [35] R. S. Rao, K. Ravindra, K. Satish, and S. V. L. Narasimham, "Power loss minimization in distribution system using network reconfiguration in the presence of distributed generation," *IEEE Trans. Power Syst.*, vol. 28, no. 1, pp. 317–325, Feb. 2013.
- [36] U. Sultana, A. B. Khairuddin, M. M. Aman, A. S. Mokhtar, and N. Zareen, "A review of optimum DG placement based on minimization of power losses and voltage stability enhancement of distribution system," *Renew. Sustain. Energy Rev.*, vol. 63, pp. 363–378, Sep. 2016.
- [37] M. Usman, M. Coppo, F. Bignucolo, and R. Turri, "Losses management strategies in active distribution networks: A review," *Electr. Power Syst. Res.*, vol. 163, pp. 116–132, Oct. 2018.
- [38] L. Shi and M. Y. L. Chew, "A review on sustainable design of renewable energy systems," *Renew. Sustain. Energy Rev.*, vol. 16, no. 1, pp. 192–207, Jan. 2012.
- [39] A. GhaffarianHoseini, N. D. Dahlan, U. Berardi, A. GhaffarianHoseini, N. Makaremi, and M. GhaffarianHoseini, "Sustainable energy performances of green buildings: A review of current theories, implementations and challenges," *Renew. Sustain. Energy Rev.*, vol. 25, pp. 1–17, Sep. 2013.
- [40] S. Deng, Y. J. Dai, R. Z. Wang, and X. Q. Zhai, "Case study of green energy system design for a multi-function building in campus," *Sustain. Cities Soc.*, vol. 1, no. 3, pp. 152–163, Oct. 2011.
- [41] H. Lund, A. Marszal, and P. Heiselberg, "Zero energy buildings and mismatch compensation factors," *Energy Buildings*, vol. 43, no. 7, pp. 1646–1654, Jul. 2011.
- [42] A. Mwashia, R. G. Williams, and J. Iwaro, "Modeling the performance of residential building envelope: The role of sustainable energy performance indicators," *Energy Buildings*, vol. 43, no. 9, pp. 2108–2117, Sep. 2011.
- [43] C. Xia, Y. Zhu, and B. Lin, "Renewable energy utilization evaluation method in green buildings," *Renew. Energy*, vol. 33, no. 5, pp. 883–886, May 2008.
- [44] M. A. Effendi and M. M. Nabil, "Assessment of renewable distributed generation in green building rating system for public hospital," *Int. J. Eng. Technol.*, vol. 7, no. 3, pp. 40–45, 2018.
- [45] G. Nem. (2019). *Technical Guideline for Connection of Indirect Solar PV Power Generation for Net Energy Metering*. Accessed: Feb. 15, 2019. [Online]. Available: <http://www.seda.gov.my/reportal/nem/>
- [46] D. R. Prabha, T. Jayabarathi, R. Umamageswari, and S. Saranya, "Optimal location and sizing of distributed generation unit using intelligent water drop algorithm," *Sustain. Energy Technol. Assessments*, vol. 11, pp. 106–113, Sep. 2015.
- [47] E. Syahputra, R. A. Fajarin, and E. A. Setiawan, "Characteristic analysis of photovoltaic on-grid system in tropical region for weather-corrected performance ratio calculation method implementation," in *Proc. E3S Web Conf.*, vol. 67, 2018, pp. 1–7, doi: 10.1051/e3sconf/20186701025.
- [48] T. Aziz and T. N. S. Mithulananthan, "Identification of the weakest bus in a distribution system with load uncertainties using reactive power margin," in *Proc. 20th Australas. Univ. Power Eng. Conf. (AUPEC)*, 2010, pp. 1–6.
- [49] G. Murthy, "Voltage stability analysis of radial distribution networks with distributed generation," *Int. J. Electr. Eng. Inform.*, vol. 6, no. 1, p. 195, 2014.
- [50] V. Van Thong, J. Driesen, and R. Belmans, "Interconnection of distributed generators and their influences on power system," *Int. Energy J.*, vol. 6, no. 1, pp. 127–140, 2005.
- [51] A. M. Khalid, "Performance ratio—crucial parameter for grid connected PV plants," *Renew. Sustain. Energy Rev.*, vol. 65, pp. 1139–1158, Nov. 2016.
- [52] M. A. Eltawil and Z. Zhao, "Grid-connected photovoltaic power systems: Technical and potential problems—A review," *Renew. Sustain. Energy Rev.*, vol. 14, no. 1, pp. 112–129, Jan. 2010.

- [53] *Photovoltaic System Performance Monitoring. Guidelines for Measurement, Data Exchange and Analysis*, Standard BS EN 61724:1998, 1998.
- [54] B. Marion, J. Adelstein, K. Boyle, H. Hayden, B. Hammond, T. Fletcher, B. Canada, D. Narang, A. Kimber, L. Mitchell, G. Rich, and T. Townsend, "Performance parameters for grid-connected PV systems," in *Proc. Conf. Rec. 31st IEEE Photovoltaic Specialists Conf.*, Jan. 2005, pp. 1601–1606.
- [55] L. Clavadetscher, *Country Reports on PV System Performance*, document, IEA-PVPS Task 2, 2004, pp. 1–35.
- [56] J. Copper, "Australian technical guidelines for monitoring and analysing photovoltaic systems," *Austral. Photovoltaic Inst.*, vol. 1, no. 1, p. 44, 2013.
- [57] H. Haeberlin and C. Beutler, "Normalized representation of energy and power for analysis of performance and on-line error detection in PV-systems," in *Proc. 13th EU PV Conf.*, Nice, France, 1995, p. 934.
- [58] E. Kymakis, S. Kalykakis, and T. M. Papazoglou, "Performance analysis of a grid connected photovoltaic park on the island of crete," *Energy Convers. Manage.*, vol. 50, no. 3, pp. 433–438, Mar. 2009.
- [59] S. Ransome, J. Sutterlueti, and R. Kravets, "How kWh/kWp modelling and measurement comparisons depend on uncertainty and variability," in *Proc. 37th IEEE Photovoltaic Spec. Conf.*, Jun. 2011, pp. 003590–003595.
- [60] E. F. Brigham and M. C. Ehrhardt, *Financial Management*. Mason, OH, USA: South-Western Cengage Learning, 2005.
- [61] O. T. San and C. H. Thum, "Net present value and payback period for building integrated photovoltaic projects in Malaysia," *Int. J. Acad. Res. Bus. Social Sci.*, vol. 3, no. 2, p. 153, 2013.
- [62] W. Hoffmann, "PV solar electricity industry: Market growth and perspective," *Sol. Energy Mater. Sol. Cells*, vol. 90, nos. 18–19, pp. 3285–3311, Nov. 2006.
- [63] D. T. P. Wijesuriya, K. D. S. H. Wickramathilaka, L. S. Wijesinghe, D. M. Vithana, and H. Y. R. Perera, "Reduction of solar PV payback period using optimally placed reflectors," *Energy Procedia*, vol. 134, pp. 480–489, Oct. 2017.
- [64] G. C. Bakos, M. Soursos, and N. F. Tsagas, "Technoeconomic assessment of a building-integrated PV system for electrical energy saving in residential sector," *Energy Buildings*, vol. 35, no. 8, pp. 757–762, Sep. 2003.
- [65] Z. Peng, M. R. Herfatmanesh, and Y. Liu, "Cooled solar PV panels for output energy efficiency optimisation," *Energy Convers. Manage.*, vol. 150, pp. 949–955, Oct. 2017.
- [66] B. Chang and K. Starcher, "Evaluation of wind and solar energy investments in Texas," *Renew. Energy*, vol. 132, pp. 1348–1359, Mar. 2019.
- [67] S. Seme, K. Sredenšek, Z. Praunseis, B. Štumberger, and M. Hadžiselimović, "Optimal price of electricity of solar power plants and small hydro power plants—Technical and economical part of investments," *Energy*, vol. 157, pp. 87–95, Aug. 2018.
- [68] B. P. Numbi and S. J. Malinga, "Optimal energy cost and economic analysis of a residential grid-interactive solar PV system—case of eThekwinini municipality in South Africa," *Appl. Energy*, vol. 186, pp. 28–45, Jan. 2017.
- [69] S. Thompson and B. Duggirala, "The feasibility of renewable energies at an off-grid community in Canada," *Renew. Sustain. Energy Rev.*, vol. 13, no. 9, pp. 2740–2745, Dec. 2009.
- [70] A. H. Mirzakhosseini and T. Taheri, "Environmental, technical and financial feasibility study of solar power plants by RETScreen, according to the targeting of energy subsidies in Iran," *Renew. Sustain. Energy Rev.*, vol. 16, no. 5, pp. 2806–2811, Jun. 2012.
- [71] G. C. Bakos and M. Soursos, "Techno-economic assessment of a stand-alone PV/hybrid installation for low-cost electrification of a tourist resort in Greece," *Appl. Energy*, vol. 73, no. 2, pp. 183–193, Oct. 2002.
- [72] L. Dusonchet and E. Telaretti, "Comparative economic analysis of support policies for solar PV in the most representative EU countries," *Renew. Sustain. Energy Rev.*, vol. 42, pp. 986–998, Feb. 2015.
- [73] A. D. Adam and G. Apaydin, "Grid connected solar photovoltaic system as a tool for green house gas emission reduction in Turkey," *Renew. Sustain. Energy Rev.*, vol. 53, pp. 1086–1091, Jan. 2016.
- [74] S. Rehman, M. A. Bader, and S. A. Al-Moallem, "Cost of solar energy generated using PV panels," *Renew. Sustain. Energy Rev.*, vol. 11, no. 8, pp. 1843–1857, Oct. 2007.
- [75] R. Crawford, G. J. Treloar, R. J. Fuller, and M. Bazilian, "Life-cycle energy analysis of building integrated photovoltaic systems (BiPVs) with heat recovery unit," *Renew. Sustain. Energy Rev.*, vol. 10, no. 6, pp. 559–575, 2006.
- [76] A. Chel, G. N. Tiwari, and A. Chandra, "Simplified method of sizing and life cycle cost assessment of building integrated photovoltaic system," *Energy Buildings*, vol. 41, no. 11, pp. 1172–1180, Nov. 2009.
- [77] G. Hou, H. Sun, Z. Jiang, Z. Pan, Y. Wang, X. Zhang, Y. Zhao, and Q. Yao, "Life cycle assessment of grid-connected photovoltaic power generation from crystalline silicon solar modules in China," *Appl. Energy*, vol. 164, pp. 882–890, Feb. 2016.
- [78] S. Rodrigues, R. Torabikalaki, F. Faria, N. Cafôfo, X. Chen, A. R. Ivaki, H. Mata-Lima, and F. Morgado-Dias, "Economic feasibility analysis of small scale PV systems in different countries," *Sol. Energy*, vol. 131, pp. 81–95, Jun. 2016.
- [79] R. Wang, C.-M. Lam, S.-C. Hsu, and J.-H. Chen, "Life cycle assessment and energy payback time of a standalone hybrid renewable energy commercial microgrid: A case study of town island in Hong Kong," *Appl. Energy*, vol. 250, pp. 760–775, Sep. 2019.
- [80] Y. Fan and X. Xia, "A multi-objective optimization model for energy-efficiency building envelope retrofitting plan with rooftop PV system installation and maintenance," *Appl. Energy*, vol. 189, pp. 327–335, Mar. 2017.
- [81] J. Jamian, "Reconfiguration distribution network with multiple distributed generation operation types using simplified artificial bees colony," *Int. Rev. Electr. Eng.*, vol. 7, no. 4, pp. 5108–5118, 2012.
- [82] M. N. B. Muhtazaruddin, N. D. Tuyen, G. Fujita, and J. J. B. Jamian, "Optimal distributed generation and capacitor coordination for power loss minimization," in *Proc. IEEE PES T&D Conf. Expo.*, Apr. 2014, pp. 1–5.
- [83] M. N. B. Muhtazaruddin, N. A. Bani, S. A. M. Aris, S. Z. A. Jalil, H. M. Kaidi, A. Y. A. Fatah, J. J. Jamian, F. Muhammad-Sukki, and S. H. Abu-Bakar, "Distribution power loss minimization via distributed generation, capacitor and network reconfiguration," *Indonesian J. Elect. Eng. Comput. Sci.*, vol. 5, no. 3, pp. 488–495, 2017.
- [84] *Asset and Services Information System (ASIS)*, ASIS, Eng. Services Division, Ministry Health Malaysia, Putrajaya, Malaysia, 2020.
- [85] N. Acharya, P. Mahat, and N. Mithulananthan, "An analytical approach for DG allocation in primary distribution network," *Int. J. Electr. Power Energy Syst.*, vol. 28, no. 10, pp. 669–678, Dec. 2006.
- [86] H. C. Box, *Set Lighting Technician's Handbook: Film Lighting Equipment, Practice, and Electrical Distribution*. London, U.K.: Focal Press, 2013.
- [87] E. K. Bawan, "Distributed generation impact on power system case study: Losses and voltage profile," in *Proc. 22nd Australas. Univ. Power Eng. Conf. (AUPEC)*, 2012, pp. 1–6.



MOHD EFFENDI AMRAN (Member, IEEE) received the Higher National Diploma (HND) from the British Malaysia Institute (BMI), Kuala Lumpur, Malaysia, and the M.Eng. degree from The University of Hull, U.K. He is currently a Senior Engineer and served duty with the Engineering Services Division, Ministry of Health Malaysia. He is also a Professional Engineer registered with the Board of Engineer Malaysia, a Certified Energy Manager (CEM) and a Registered

Electrical Energy Manager (REEM) registered with Energy Commission of Malaysia. He is entering a full-time Ph.D. program at University Teknologi Malaysia (UTM). He is a well-trained government officer, where his previous nature of work in leading a group of Engineers through managing, planning, designing and implementing the various type of public hospital projects all around Malaysia had gained him with potential engagement among key personnel, and organizations locally and internationally. He had started his Engineering education journey with Certificate of Technology in Electrical Domestic and Industry at the Institut Kemahiran Mara (IKM), Perlis, Malaysia. He also been examined and qualified for Wireman PW4, IKM.



dg location-sizing, network reconfiguration, capacitor placement, optimization method and smart grid.

MOHD NABIL MUHTAZARUDDIN received the B.Eng. and M.Eng. degrees from Universiti Teknologi Malaysia (UTM), Johor Bahru, Malaysia, in 2008 and 2010, respectively, and the Ph.D. degree from the Shibaura Institute of Technology, Tokyo, in 2014. He is currently a Senior Lecturer with the Engineering Department under Razak Faculty of Technology and Informatics, Universiti Teknologi Malaysia. His current research interests include renewable energy,



joining the academia, he was a technician for Intel Technology-based in Kulim, Malaysia.

AHMAD SYAHRIR AYUB is currently a Lecturer in electrical engineering with the School of Engineering, Robert Gordon University (RGU), Aberdeen, U.K. Prior to RGU, he also worked as a Lecturer with the Perth College, Universities of the Highlands and Islands and a Researcher with the High Voltage Technologies (HVT) Group, University of Strathclyde. His research interest include lightning, lightning protection, cable diagnostics, and renewable energy (wind and solar). Prior to



the Graduate Member for Board of Engineers Malaysia (BEM) and the Institution of Engineers, Malaysia (IEM). She is also a member of International Association of Hydrological Sciences (IAHS), International Association of Hydrogeologists (IAH), and American Geophysical Union. She is currently a Registered EIA subject specialist in Malaysia. In UTM, she is the member of Sustainability Resource Research Alliance. Her current research interests are sustainable infrastructure in practice, environmental issues and assessment, and environmental hydrology and hydrogeology. In the past few years, she has actively conducted research and consultation works for tropical environment and sustainability including flood hazard mapping, flood and drought effects, soil water estimation using GPR, geoengineering, and indoor thermal assessment. Her reviews and findings have been published in Scopus or Web of Science indexed journals and many international conferences. She has taught many undergraduate and postgraduate courses within Civil Engineering field of study for more than 20 years.

SAMIRA ALBATI KAMARUDDIN received the Bachelor in Civil Engineering degree from UTM, In 1998, the Master of Engineering degree in hydrology and water resources from UTM, in 2002, and the Ph.D. degree in environmental hydrology and hydrogeology from Universiti Putra Malaysia (UPM), in 2013. She is currently an Associate Professor with the Razak Faculty of Technology and Informatics, Universiti Teknologi Malaysia (UTM), Kuala Lumpur. She registered as



saltwater battery. She also works on the development of the IoT system for monitoring health status, especially for post stroke and post brain injury patient. She has authored or coauthored several articles in various technical and high-impact factor journals as well as conference proceedings. She is also actively involves in many community programs. Her research interests include polymeric insulation material, space charge measurement, high-voltage cable, renewable energy, rural technology, and rehabilitation engineering. She received two academic awards for outstanding academic performance from University of Southampton.

NURUL AINI BANI received the M.Eng. degree in electrical engineering from the University of Southampton, U.K., in 2006, and the Ph.D. degree in electrical engineering from Universiti Teknologi Malaysia (UTM). She is currently a Senior Lecturer with the Razak Faculty of Technology and Informatics, Universiti Teknologi Malaysia, Kuala Lumpur. Her current work concentrates on developing low-cost renewable energy system for rural and remote area, namely solar concentrator, and



optical concentrator, which can be used in many applications including creating a low cost solar photovoltaic system, illumination, heating and cooling of buildings, energy harvesting, desalination, medical devices, waste water treatment etc. On top of that, he also carried out a number of non-technical research including market trends and financial analysis related to renewable technologies for selected countries. Prior to joining the academia, he was a communication engineer in Malaysia's largest telecommunication company.

FIRDAUS MUHAMMAD-SUKKI received the M.Eng. degree in electrical and electronic engineering from Imperial College, in 2006, and the Ph.D. degree in solar engineering from Glasgow Caledonian University, in 2013. He is currently a Chartered Engineer, a member of the Institution of Engineering and Technology (IET), and an Associate of the City and Guilds, London (ACGI). He is also a Lecturer with Robert Gordon University, U.K. His research interest include designing



data modeling. He has published numerous of book and academic articles that related with big data, risk analysis, and environmental data modeling. He is working on with biomedical science research that focused on the development of gadget that able to alarm an early warning for Retinopathy diseases among diabetic patients. He was being appointed as an editorial board by several high-impact publishers as an appreciation of his high-quality of work in research. His contribution in his field also has been recognized from several local universities in Malaysia. This recognition was proven since he was being appointed as a subject matter expert under Open University Malaysia and allied co-researcher members under Cyber Security and System Unit, Universiti Sains Islam Malaysia.

AHMAD SHAKIR MOHD SAUDI received the Ph.D. degree in environmental forensic science with the study on the development of flood risk index. He is currently a Senior Lecturer with the Institute of Medical Science Technology, Universiti Kuala Lumpur, Malaysia. He is very active in research and was being appointed as Principal Research Investigator of Environmental Health Research Cluster, (EHReC- UniKL), in 2017. He is an expert in Chemometric techniques and



Scotland's Energy Technology Partnership (ETP). She is an Associate of the City and Guilds, London (ACGI). Her interests include solar PV, solar thermal, financial planning, and investment analysis.

SITI HAWA ABU-BAKAR received the B.Eng. degree in information systems engineering from Imperial College, London, in 2006, under the MARA scholarship, and the Ph.D. degree in solar technology in 2016. In 2007, she joined Prokhas Sdn. Bhd., a wholly-owned company under the Ministry of Finance Malaysia as the Executive Trainee. From 2008 onwards, she becomes a unit trust consultant for Public Mutual Bhd. In 2011, she was awarded studentships from GCU and



University of Chile. His research interests include partial discharges, insulation systems diagnosis, and instrumentation and measurement techniques for high-frequency currents.

JORGE ALFREDO ARDILA-REY (Member, IEEE) was born in Santander, Colombia, in 1984. He received the B.Sc. degree in mechatronic engineering from the Universidad de Pamplona, Pamplona, Colombia, in 2007, the Specialist Officer degree in naval engineering from Escuela Naval Almirante Padilla, Cartagena, Colombia, in 2008, and the M.Sc. and Ph.D. degrees in electrical engineering from the Universidad Carlos III de Madrid (UC3M), in 2012 and 2014, respectively.