

Received April 8, 2020, accepted April 23, 2020, date of publication April 29, 2020, date of current version May 14, 2020.

Digital Object Identifier 10.1109/ACCESS.2020.2991269

Recent Advancements in Defected Ground Structure-Based Near-Field Wireless Power Transfer Systems

KASSEN DAUTOV¹, MOHAMMAD HASHMI¹, (Senior Member, IEEE),
GALYMZHAN NAURYZBAYEV¹, (Member, IEEE),
AND N. NASIMUDDIN², (Senior Member, IEEE)

¹Electrical and Computer Engineering Department, Nazarbayev University, 010000 Nur-Sultan, Kazakhstan

²Institute for Infocomm Research, Agency for Science, Technology and Research (A*STAR), Singapore 138632

Corresponding author: Kassen Dautov (kassen.dautov@nu.edu.kz)

This work was supported by the Nazarbayev University FDRG Program under Grant SOE2019005 (110119FD4515) and Grant SEDS2020014 (240919FD3935).

ABSTRACT The defected ground structure (DGS) technique enables miniaturization of the resonator which leads to the development of the compact near-field wireless power transfer (WPT) systems. In general, numerous challenges are inherent in the design of the DGS-based WPT systems and, hence, appropriate trade-offs for achieving optimal performance are required. Furthermore, the design advancements have led to the development of the DGS-based multi-band WPT systems to fulfill the needs of simultaneous data and power transfer. The innovations in the DGS-based WPT systems have also resulted in the definition of more commonly used figures-of-merit for the benchmarking of various performance metrics. The literature is replete with the design schemes to address one or more associated design challenges and successful WPT system realizations with enhanced performance. With this in mind, this paper touches upon the DGS-based WPTs developments and presents a concise report on the current state-of-the-art and future directions.

INDEX TERMS Coupling, defected ground structure (DGS), multi-band, resonator, Q factor, single-band, wireless power transfer (WPT).

I. INTRODUCTION

Nowadays replacing wires by applying wireless power transfer (WPT) systems has become very attractive since the latter enables the charging of multiple electronic devices simultaneously [1] and powering the sensors with very low power consumption [2], [3]. Transmission of electrical power through free space using radio waves, *i.e.*, essentially entails the transmission of electrical energy without employing any physical link. The concept of WPT can be traced back to 1888 when Heinrich Hertz demonstrated, for the first time, wireless transmission of power [4], [5]. However, it is also imperative to mention that the modern world considers Nikola Tesla as the father of WPT as he was the first to experiment and document his work on WPT way back in 1899 [6]–[8].

In general, it is feasible to divide WPTs into two categories, namely, far-field WPT [9] and near-field WPT [10], [11].

The associate editor coordinating the review of this manuscript and approving it for publication was Yiming Huo¹.

The far-field WPTs, which are radiative in nature, find usefulness in applications such as satellite communications [12], unmanned aerial vehicles (UAVs) [13], and vehicular communication (VC) [14]. On the other hand, the near-field WPTs (*i.e.*, non-radiative) require a short range and are useful for applications including but not limited to implantable microelectronic devices (IMDs) [15]–[17], radio-frequency identifiers (RFIDs) [18], drug delivery systems [19], micro-robotics [20], consumer electronics (CE) [21], [22], wireless body area network (WBAN) [23]–[25], electrical vehicles (EVs) charging [26], [27], and sensors employed in biomedical domain [28]–[30]. A generic schematic of WPT and its potential applications are depicted in Figure 1. In this context, it is pertinent to mention that numerous WPT techniques, which revolve around concepts such as inductive coupling [31], magnetic resonance [32], metasurfaces [33]–[35], capacitive coupling [36], lasers [37], *etc.*, have been proposed to facilitate both near- and far-field WPT applications.

TABLE 1. The parametric comparison of the DGS- and coil-based near-field WPT techniques.

Parameters	DGS	Coil (incl. planarized)
Operating frequency [19], [22], [44], [64]	high (> 100 MHz)	low (< 100 MHz)
Power transfer efficiency [19], [44], [63], [69], [70]	moderate (60 – 75%)	low (< 50% at low frequencies)
Power transfer distance [21], [40], [57], [64]	moderate	high
Implementation [22], [44], [57]	easy	complicated
Equivalent circuit [20], [66], [67]	complicated (quasi-static)	easy
Multi-band operation [19], [64], [68], [70]	+	–
Frequency split phenomenon [32], [64], [65], [71], [74]	+	+
Robustness [48], [57]	+	–
High Q realization [22], [49], [62]	+	+ (when planarized)
Cost [44], [48]	–	+
Compactness [19], [48], [64], [67]	+	–
Ease of design [18], [62]	+	–
Misalignment sensitivity [48], [50], [69]	+	+

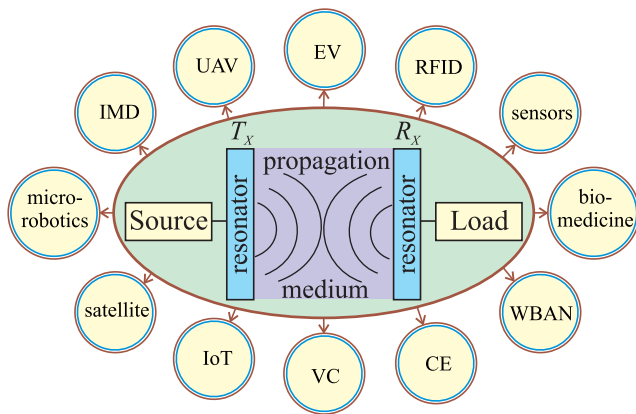
**FIGURE 1.** The potential applications of the WPT systems.

Within the scope of near-field WPTs, three distinct coupling-based techniques, namely, capacitive [38], inductive [39], and magnetic resonance [40], have been widely explored. Out of these, the capacitive one possesses a smaller power transfer range as compared to the other approaches and, therefore, finds limited usefulness in practical applications [41]. On the other hand, the inductive and resonant coupling-based WPTs, with a relatively longer power transmission distance, are built around metallic coils [42]. There have been a number of advancements in such techniques, considering that the evolution in technology enabled the design of printed coils and spirals using microstrip lines (MLs) [43], [44]. Several design reports related to the resonance coupling-based WPT systems focus power on certain carrier frequency and, as a consequence, the efficiency of the system improves. Therefore, such WPTs exhibit a better performance as compared to the systems based on the inductive coupling [45], [46]. In general, the realization of the resonance coupling requires a resonator [47], and a defected ground structure (DGS) technique can aid in the development of the needed resonators that possess quasi-lumped resonant circuit behavior [48], [49]. In this regard, it is imperative to mention that resonance coupling-based near-field WPTs can be achieved using either the coil (including planarized

ones) or DGS. Therefore, keeping the specifications and other design goals in perspective, these approaches are compared in Table 1.

A simple literature search related to the near-field WPT systems using coils (including the printed ones) conveys that a number of innovative design techniques, analysis methods, and performance-enhancing approaches have been reported [32], [50]–[56]. For example, the WPT performance worsens in the presence of lateral and angular misalignment between the transmitting and receiving coils, and this issue was addressed by a new design configuration [50]. There are often mutual coupling issues between the transmitter (T_X) and receiver (R_X) and that can be mitigated by the incorporation of a switchable circuit with capacitors in designed WPT [51]. It has been established that the mutual inductance (M) and coupling between resonators significantly impact the performance of coil-based WPT systems and [52] proposed an analytical solution that can in advance predict M between the planar coils. Sometimes, there may be issues due to over-coupling as it creates a split in the resonant frequency and, hence, in the performance of WPT [32], and an analytical technique to address this concern related to the frequency splitting phenomenon was reported in [53]. It is pertinent to mention that coupling-based WPT techniques rely on a high-quality factor (Q) of resonators to enhance the performance. This was aptly demonstrated through a very intuitive design using a double-sided substrate integrated suspended line technology to enhance the Q factor of the conventional printed spiral inductors [54]. Some of the reported spiral-based WPT systems were application-specific, *e.g.*, a high-efficiency WPT for IMDs by considering various standardized frequencies [55] and different signal carriers [56]. A brief survey on the coil-based WPT systems reveals that these systems are promising and can transfer power to relatively longer distances. However, they are limited in utility at higher frequencies in the radio waves spectrum owing to large circuit dimensions [20], [40], fabrication complexity [57], and the bulkiness of the system [48]. Planarizing the coils mitigates such challenges to some extent but, still, these do not fulfill the needs of applications requiring miniaturization

and simpler design with very high efficiency in lieu of the reduced power transmission range [58]–[60].

The coupling-based WPT systems and techniques developed using DGS resonators have been getting tremendous attention in the past few years. One of the key factors contributing to this traction is the ability of DGS to provide definite benefits in terms of the miniaturization and compactness of the WPT systems [61]. Furthermore, other benefits of this technique over the coil-based approach include the ease of design and implementation [62], robustness and reliability [57], cost-effectiveness and relatively lower losses [48], and more freedom in the realization of high Q by controlling the geometry of DGS shapes [63]. The major challenges encountered by the DGS-based WPT systems are relatively smaller power transfer distance [64], [65] and complicated quasi-static equivalent circuit of DGS shapes [57], [66]. In this instance, it is worth mentioning that numerous challenges in the design of such systems occur due to the trade-offs among the power transmission range, efficiency, size, and design complexity. However, any comprehensive yet succinct information about these aspects is unavailable. Therefore, this paper aims to fill this gap by providing an extensive resource about the challenges, design techniques to overcome them, performance enhancement approaches, and research directions related to the DGS-based WPT systems.

The organization of the rest of this article is as follows. Section II elaborates on the state-of-the-art of the DGS-based WPT systems. Section III introduces the major challenges of DGS-based WPTs as well as the features of the DGS technique, analyses of various DGS shapes, and illustration of the main design steps. Section IV presents some successfully implemented DGS-based WPT systems in recent years. Finally, the potential research directions of the DGS-based WPT systems are elaborated in Section V, while Section VI concludes the paper.

II. RECENT ADVANCEMENTS OF DGS-BASED WPTs

The realization of the WPT systems requires the utilization of two coupled (see Figure 2) antennas, acting roles of a transmitter and a receiver, both resonating at the same frequency. There has been an upward spike in the use of the DGS-based resonators in the WPT systems as it leads to circuit size reduction [63], [67]. The first report of DGS-based WPT was developed around H-shaped resonators [48]. Subsequently, various analyses and design approaches to enhance this work both in terms of performance as well as ease of design have been reported [65], [68]. In particular, the J -inverter theory seems very promising as it readily aids in the analysis and extraction of the WPT equivalent circuit element values [19], [62]. Some reported works showed the impact of misalignment between T_X and R_X by presenting numerous studies [57], [69]. Furthermore, the literature is also replete with recent papers which broadened the WPT schemes to both wireless power and information transfer by proposing multi-band WPT systems [64], [70]. Then, there have been efforts to benchmark the WPT systems by proposing standard

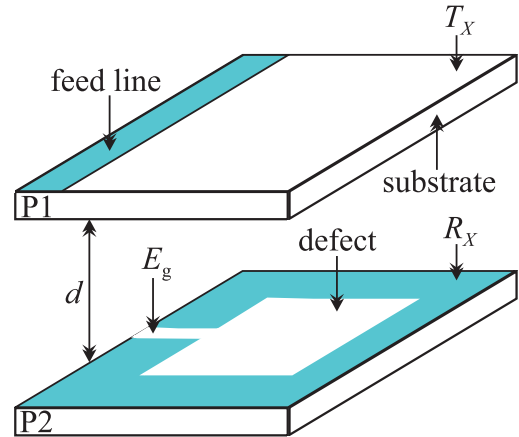

FIGURE 2. Coupling example of two DGS-based resonators. P1 and P2 stand for the input and output ports, respectively. Note that the defect type can be replaced by any shape.

metrics such as the figure-of-merit (FoM). The FoM essentially includes all the key parameters of WPTs, namely, power transfer distance (d), circuit size, and efficiency (η) of the delivered power to R_X . In addition, the further advancements in the variously shaped single-band DGS WPTs are compared in terms of FoM (see Figure 3) and the other parameters are listed in Table 2.

TABLE 2. Performance comparison of the DGS-based WPT systems (* – single-band, ° – dual-band, and † – tri-band).

Ref.	η (%)	d mm	size mm \times mm	FoM
[48]*	85	5	25 \times 25	0.17
[49]*	68.5	50	40 \times 40	0.856
[57]*	73	25	21 \times 21	0.86
[62]*	71	11	20 \times 20	0.39
[63]*	61	50	50 \times 50	0.61
[67]*	63	40	30 \times 30	0.84
[71]*	64.6	44	35.8 \times 20	1.06
[72]*	86	35	30 \times 30	1.003
[19]°	71/72	16	30 \times 15	0.757/0.772
[64]°	71/81	15	18 \times 18	0.84/0.96
[65]°	60/67	3.5	15 \times 10	0.17/0.19
[68]°	58/74	17.5	34 \times 20	0.55/0.69
[73]°	70/69	40	50 \times 50	0.56/0.55
[74]°	80/73	17	20 \times 20	0.68/0.62
[70]†	68/60/65	30	50 \times 50	0.4/0.36/0.39

As mentioned earlier, η is one of the critical parameters of WPTs that heavily depends on the resonator’s inductance (L), *i.e.*, a higher value of L results in efficiency enhancement. This phenomenon was examined through different shapes of DGSs, such as H, semi-H, and two-turn square DGS [49], [57]. It was shown that semi-H shape has greater inductance as compared to H shape because of possessing only one current path and, therefore, the WPT systems employing this resonator exhibit higher efficiency. Moreover, two-turn square DGS also has higher inductance in contrast to H shape because of the extended current loop and, therefore, its use also enhances the WPTs efficiency. Moving forward, the

positive influence of Q on a system efficiency was demonstrated by exploiting the dual-E shape DGS [62]. It was also shown, that the efficiency of WPTs is severely impacted by the propagation medium and, therefore, should be taken into account for any practical situation [63]. In addition, the efficiency is greatly impacted by misaligned T_X and R_X resonators and it was investigated using a semi-elliptic DGS [69]. The efficiency also gets enhanced substantially in multi-band WPT systems as well which is apparent from the developed dual-band WPT system based on cascades of a circular DGS [19].

The power transmission range is another very important aspect of any WPT system and, therefore, a number of reports, based around a variety of DGS shapes, tried to improve d . It has been established that d is directly proportional to the value of a coupling coefficient (k), *i.e.* higher k leads to a higher transmission range and vice-versa [71]. It was demonstrated through the use of rectangular DGS resonators which also possess a higher Q value. In addition, other reported WPT systems, that focus on a range enhancement, considered the plus and hexagonal shapes of DGSs [68], [72].

Miniaturization of WPTs is one of the most important aspects of the development of the DGS-based WPT systems for biomedical and other low-power applications. Recently reported articles tried to address this requirement. For instance, an asymmetric resonator-based WPT system, where R_X is smaller than T_X , is one solution to reduce the overall system size [67]. Other exciting designs for size miniaturization include the ultra-compact U and double-rectangular DGS shape dual-band WPT systems working at practical industrial, scientific, and medical (ISM) bands [64], [65]. Recently, the concept of multi-mode DGS resonators has been incorporated for achieving compact-sized dual- and tri-band WPT systems [70], [73]. In addition, it has been shown that the size miniaturization of dual-band WPT can also be achieved by adding a lumped capacitor to resonators [74].

III. DGS-BASED WPT DESIGN CONSIDERATIONS

Apart from the main parameters of WPTs, namely, efficiency, resonator compactness, and power transmission distance, the design of DGS-based WPTs faces inherent challenges and, therefore, requires appropriate design techniques for optimal performance. The key considerations during the design trade-offs are within the realm of the resonator design, equivalent circuit development, impedance matching, and high k and Q realization. The overall idea is to develop a precise methodology to design and realize the WPT systems possessing extremely high FoM with respect to given applications.

A. DGS TECHNIQUE

The photonic bandgap structure (PBG) or DGS techniques are capable of achieving stop-band or band-gap effects and, hence, are extremely useful in the design and development of microwave and millimeter-wave filtering circuits [75], [76]. The rejection of the desired frequencies in PBG is regulated

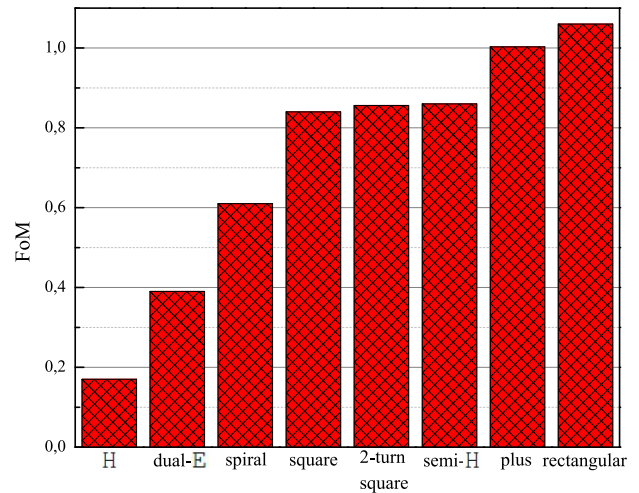

FIGURE 3. The achieved FoM values of the single-band WPT systems employing different DGS shapes.

by the number of lattices, lattice spacing, and relative volume fraction, whereas it has been well established that in the DGS technique this is primarily dependent on the physical dimensions of the etched shape in the ground plane [77], [78], as the DGS concept lies in altering the current distribution of the ground plane by introducing any type of defect on it. As a consequence, the capacitance and the inductance of the transmission line change. In general, DGS possesses numerous advantages such as the ease of modeling, simplicity in constructing the equivalent circuit, fabrication, *etc.*, hence is preferred over PBG in the design of filtering structures such as band-stop filters (BSFs) [76], low-pass filters [79], and band-pass filters [80]. Analysis of any DGS shape is extremely difficult and, therefore, it is standard practice to make use of advanced electromagnetic (EM) simulators to solve the DGS related challenges [81]. Moreover, the parameters of the DGS-based resonators can be extracted by using a simple LC tank circuit, but it cannot provide information about the physical dimensions of the introduced DGS shape and, hence, this approach cannot be considered unique for any DGS shape. For the parameter extraction of a particular DGS shape, the development of a quasi-static equivalent circuit is required [66].

Furthermore, the available literature includes diverse analyses of the DGS technique from multiple aspects. For instance, the authors in [82] improved the performance of the circuit by introducing U and V shaped DGSs compared to the earlier reported dumbbell and spiral shapes. The resonator miniaturization was achieved by utilizing bending feasibility of the microstrip in [83], while [84] reported a 94%, 57%, and 88% size reduction compared to the conventional dumbbell, H, and modified dumbbell shape-based BSFs, respectively, by embedding varactors to the circuit to enable tunable resonators. Asymmetric types of DGS were first explored in [85], where the authors concluded that this type of DGS shapes outperforms the symmetric DGS shapes in terms of

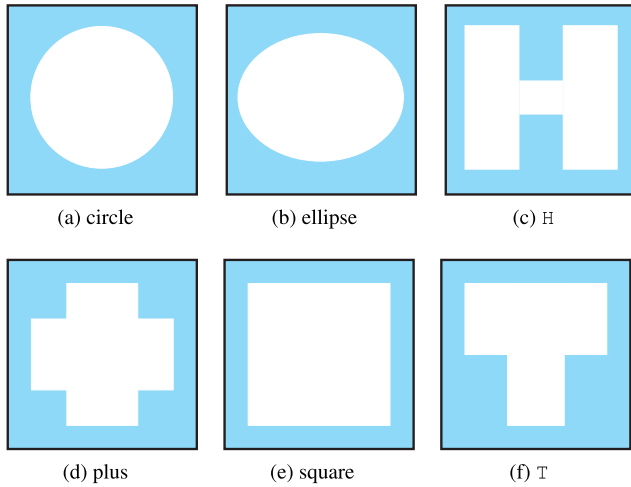

FIGURE 4. The utilized different DGS shapes.

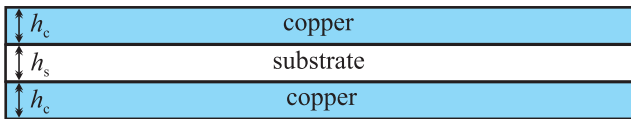

FIGURE 5. The structure of the DGS-based resonators.

the resonator size reduction. Another tunable band-stop resonator, possessing a small circuit size, employs E shape DGS which has a high Q and a sharp transition knee [76].

B. DGS SHAPE ANALYSIS

One approach of achieving a highly-efficient WPT system is to improve the Q value of a resonator [71], [86]. Therefore, this section provides analyses of various-shaped DGS-based resonators in terms of the Q value. As mentioned above, different shapes of DGS in the ground plane disturb the current distribution in varying fashion and it leads to numerous band-stop characteristics. To visualize this aspect, a brief survey was carried out and some of the common DGS shapes, shown in Figure 4, have been selected to develop BSF and analyze them in terms of Q . A typical resonator structure used in WPT systems is given in Figure 5. For the sake of precise comparison, all the resonators have been developed using the same substrate and have the same board area of $20 \times 20 \text{ mm}^2$. For completeness of these simulations, the substrate RO4350B was selected with parameters of copper thickness (h_c) = 35 μm , substrate thickness (h_s) = 1.524 mm, and a substrate permittivity (ϵ) = 3.48. The ML (*i.e.*, feed line), located just below the excitation gap (E_g), connects the input and output ports of resonators (as shown in Figure 2). It is important to mention that although the resonators possess different DGS shapes in the ground plane they are simulated under the same conditions, *i.e.*, a ratio of the copper area to the non-copper one was set to 1 : 1 for all cases. It can be inferred from the obtained results in Figure 6 that the H shaped resonator has the smallest Q value compared to the resonators of other shapes. However, it is apparent that

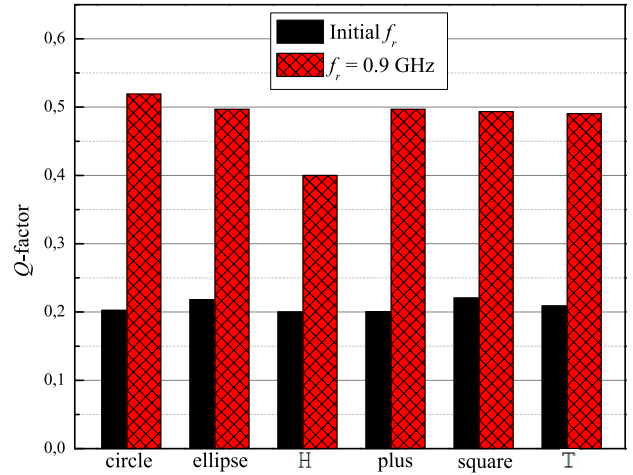

FIGURE 6. Q factor of resonators based on various considered DGS shapes.

there is no huge difference in the Q value among the chosen shapes. Subsequently, it is reasonable to conclude that the shape is not that important in achieving a high Q .

C. EQUIVALENT CIRCUIT

It has been demonstrated in [19], [62] that the validation of the DGS-based WPT systems is performed by investigating their corresponding equivalent circuits. The equivalent circuit of any DGS-based WPT system is preceded by the development of the equivalent circuit of the employed resonator (see Figure 7a). The respective parameters of this equivalent circuit require the usage of analytical expressions [64, Eqs. (1) and (2)]. In general, any WPT system is developed by coupling two resonators, and, as a consequence, a WPT system can be represented by their equivalent circuits coupling with each other as depicted in Figure 7b. Here, open stub (C_{st}) is added to fulfill the impedance matching and its detailed calculation can be found in [57]. In this instance, it should be noted that there are two ways to design a multi-band resonator, by either cascading single band-resonators [19], [72] or by utilizing multi-mode techniques [70], [73].

D. METHODOLOGY

The successful realization of any practical WPT system requires the simulation and experimental demonstration. Over the years, several techniques to design DGS-based WPT systems have been reported in [19], [49], [74]. These techniques, although, differ in implementation strategies but can still be described by a standard design procedure as structured by a flow chart depicted in Figure 8. For the sake of completeness, the design steps are elaborated below:

- At the outset, define a DGS shape and select a substrate for the intended design. For example, any shape from Figure 4 (but not limited) and the substrate RO4350B.
- Check the requirement of whether the design is multi-band or single-band. For instance, single-band is

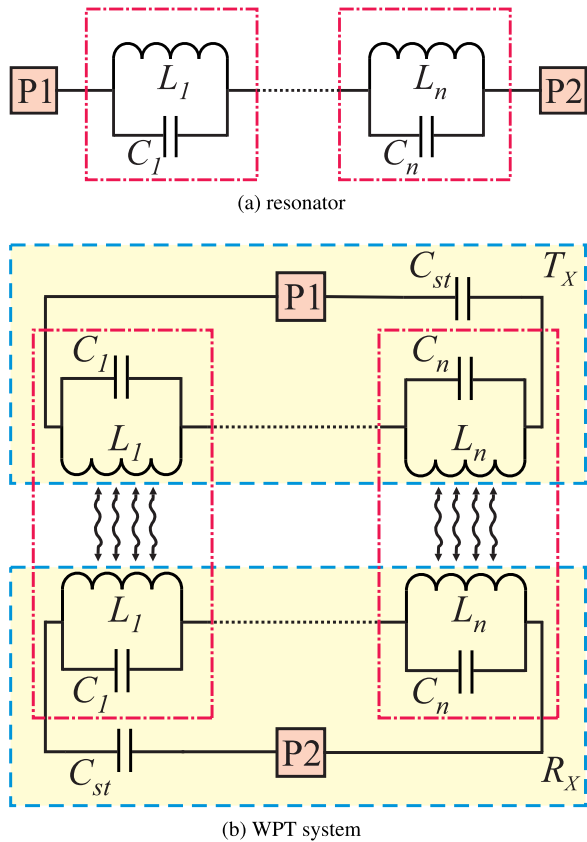

FIGURE 7. Equivalent circuits.

required only for power transfer whereas a multi-band is envisaged for power as well as information transfer. However, care should be taken so that the chosen frequencies conform to the approved standards, e.g., ISM.

- Then, specify the key parameters of the WPT system, namely, operating frequency, resonator area, and power transfer distance according to the requirements of the planned application.
- Make use of the chosen DGS shape and the specified WPT parameters to develop a resonator. Calculate the value of an external capacitor, using [64, Eq. (2)], to achieve the resonance at a chosen frequency. For multi-band resonance, either cascade multiple resonators [19], [64], [68] or follow the multi-mode techniques [70], [73]. It is important to check if the resonance requirements are satisfied.
- Subsequently, develop an equivalent circuit of the resonator to validate the obtained EM simulation results.
- In turn, to construct the WPT system's equivalent circuit, first, there is a need to couple two identical resonators and separate them by a distance d . To fulfill this necessity, carefully place two resonators in a way that no misalignment occurs between them and ensure that they remain under the perfect coupling condition. Then, use [65, Eqs. (3) and (4)] to extract the values of M and k , respectively. Finally, develop the WPT system equivalent circuit using those defined values.

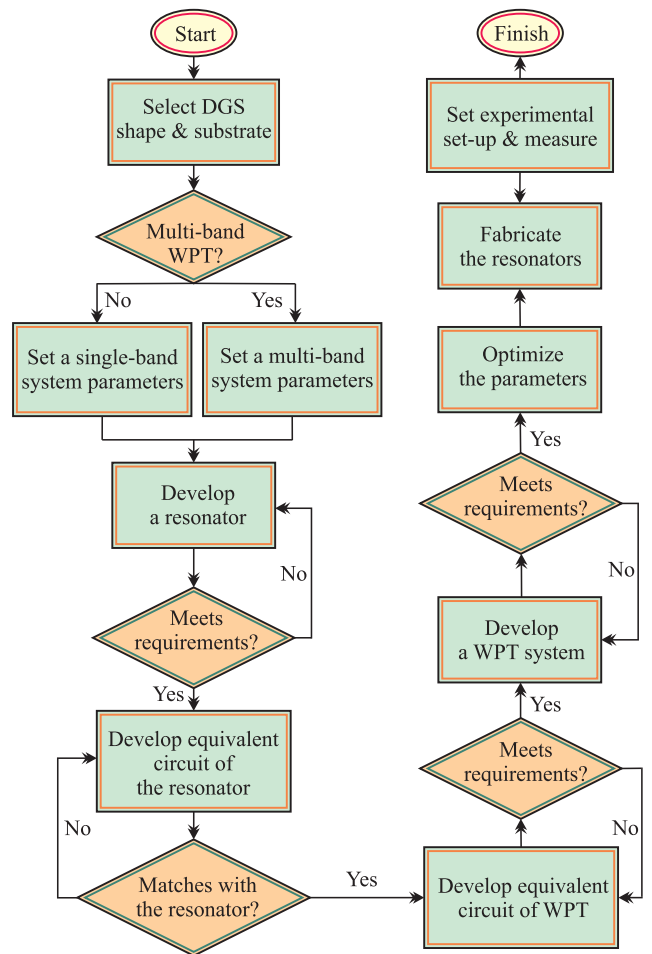

FIGURE 8. The systematic methodology of the DGS-based WPT system development.

- Perform impedance matching of the circuit, i.e., define the value of C_{st} , once the equivalent circuit of WPT is developed. Next, convert C_{st} into open-stub ML [57, Eq. (4)] and then develop the WPT system.
- Optimization of critical parameters of WPT is often necessitated to achieve the best performance and often to trade-off among performance metrics. This completes the simulation phase.
- Fabricate two resonators to initiate the experimental demonstration and solder the required lumped components of the resonators (the connectors and capacitors).
- Perform measurements using network analyzers. Store data and use (1) [72] and (2) [74] to calculate the well-accepted performance metrics of the WPT systems. However, prepare the experimental setup carefully for the precise results. A good match between the simulation and experimental results validates the design process and the realized DGS-based WPT system.

$$\eta = \frac{|S_{21}|^2}{1 - |S_{11}|^2}, \quad (1)$$

$$\text{FoM} = \eta \times \frac{d}{\sqrt{\text{average size}}}. \quad (2)$$

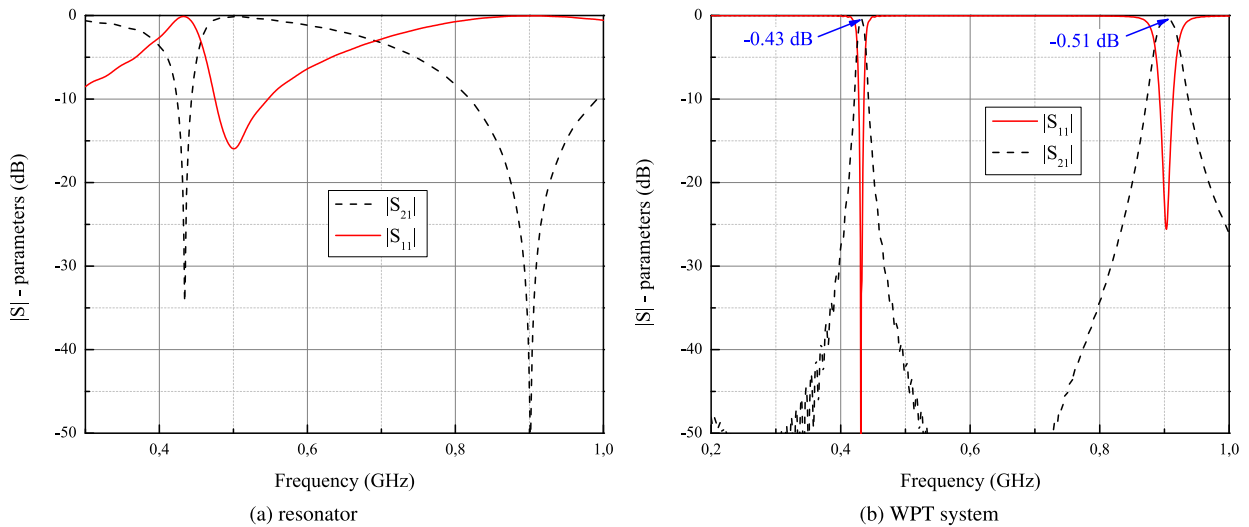

FIGURE 9. The obtained $|S|$ -parameters from EM simulations [64].

IV. REALIZED DGS-BASED WPT SYSTEM EXAMPLES

The aim of this section is to introduce the readers with some recently reported exciting DGS-based WPT designs which could bring a paradigm shift in this domain. At first, an example of a dual-band WPT system operating at 0.433 GHz and 0.9 GHz is presented to show the effectiveness of the existing methodology [64]. It can be seen in Figure 2 that a dual-band WPT system can be developed by coupling two identical resonators with a certain transmission distance between them. In particular, it is critical to determine d appropriately so that the coupled DGS-based resonators remain under a good coupling regime. For example, the EM simulations of two coupled resonators defines the WPT system results in $|S|$ -parameters depicted in Figures 9a and 9b. It can be deduced from these plots that there are two distinct resonant frequencies and they can be considered as the operating frequencies of the WPT system. These results clearly show that the DGS-based resonators are useful in realizing WPT systems. It is important to mention that these frequencies can be easily regulated by placing an external capacitor to the utilized resonators.

The next step, as mentioned in Section III-C, entails the development of the equivalent circuit model of the resonators and corresponding WPT system for validation of the achieved results. The two-step validation gives confidence in the designed WPT system before eventual fabrication. It is anticipated that the measured values of $|S|$ -parameters will follow the simulation results. In case of any anomaly, slight adjustments in the design stage need to be carried out along with the care in the measurement. From the achieved plots, in this case, equations (1) and (2) give the efficiencies of 90% and 88% at the two chosen frequencies while the corresponding FoMs are 1.06 and 1.03.

Over the years there have been numerous successful realizations of the DGS-based WPT systems. For example, one

such design reported in [57] aroused a keen interest in the DGS-based WPT system. This design, depicted in Figure 10a, was considered very advanced at the time of its reporting. It provided an efficiency of 73% at the designed frequency of 0.3 GHz. Similarly, a recent design, depicted in Figure 10b, delves into the dual-band WPT system for practical ISM bands and has the potential for its usage in real-life scenarios [64]. Another multi-band design, given in Figure 10c, is the first time a tri-band WPT system [70] has been presented and it definitely opens the door for real-time applications of such systems in simultaneous power and information transfer.

V. ONGOING RESEARCH INVESTIGATIONS

The recent reports in the field of DGS-based WPT systems address the issues related to the main challenges such as power transfer efficiency, distance, circuit size, high Q realization, etc. For instance, most of the papers often reported the analysis and design process and overlooked the issues encountered in the overall WPT system design. In particular, some DGS-based designs provided peripheral analysis using their quasi-static equivalent circuits [57], [67], but most of the designs did not employ this approach and, hence, it may not be possible to understand the anomaly in their respective EM and circuit simulation results. In particular, such an inference can be drawn from most of the recent designs [49], [62] due to the absence of any unified approach adopted for the development of the WPT system’s equivalent circuit. This fact opens up an opportunity for advanced research in developing a standardized approach for the WPT equivalent circuit. This has the potential to assist performance validation prior to the fabrication stage and, thus, can aid in the successful first-pass WPT design. As mentioned previously, the operating distance and power transfer efficiency in such systems can

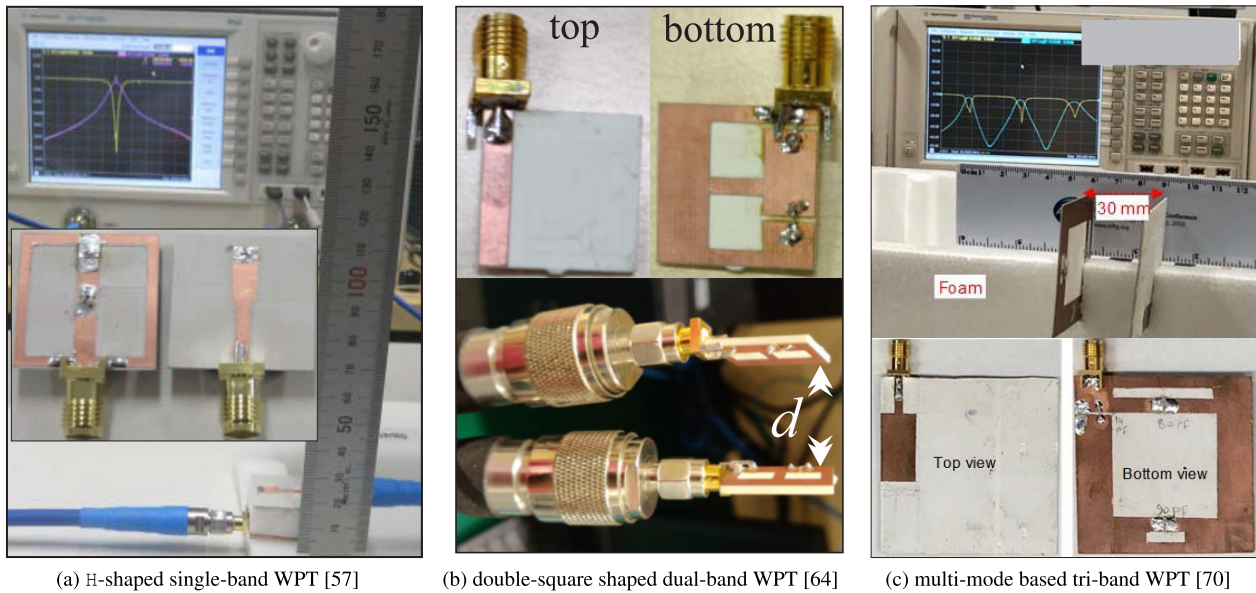

FIGURE 10. Successfully realized DGS-based WPT systems: (a) single-band WPT; (b) dual-band WPT; (c) tri-band WPT.

be accomplished by high Q resonators, but none of the realized WPT systems reported so far achieved more than 85% efficiency [49], [73]. This again throws an open challenge to designers to tread this path of high Q resonators design with target applications in the WPT systems. Furthermore, the misalignment between T_X and R_X has a severely detrimental effect on the efficiency of WPT as reported in [48], [69]. This aspect needs to be investigated thoroughly to identify and mitigate the impact of misalignment on the WPT performance. Another factor, known as a frequency splitting, also degrades the efficiency and it can be seen in some reported papers [71], [74]. Accordingly, this phenomenon can be considered as another interesting research path.

Several reported WPTs were designed to operate at frequencies that do not comply with standards such as WBAN or ISM [70], [73]. Furthermore, there are not many reports which demonstrate the performance of WPTs in real tissue environments and, therefore, it is extremely difficult to make any judgment on their field deployments [63]. Thus, this is another open research direction for the eventual incorporation of WPTs in the biomedical field. The review results reveal that there is a need for new performance metrics for such systems that can also be applied to any WPT.

Keeping the above in mind, there is a requirement of innovative designs covering all aspects of the design process as well as the performance metrics despite the fact that the DGS-based WPT systems have gone through considerable advancements in this decade. In this context, the potential research concerns of the DGS-based WPT systems can be categorized into four main groups as shown in Figure 11. The following sub-sections elaborate on these concerns, the associated challenges, and the possible directions based on the available knowledge.

1) Performance Enhancement

- a) The WPT system's efficiency actually regulates the amount of power (received by R_X) to satisfy the needs of a wide range of applications. Here, the aim must be set to achieve an efficiency of at least 90% so that the majority of the transmitted power is received by the load side.
- b) Another critical aspect that requires considerable attention is the compactness of WPT systems considering that it will facilitate several applications such as charging of IMD batteries.
- c) The power transmission range is also very important for WPT systems. For example, consumer electronics may often benefit from the DGS-based WPT systems possessing a relatively larger power transmission range. In general, the large-sized WPT systems exhibit larger operating distance and, therefore, there exists a trade-off to achieve the optimal size and transmission range. Therefore, efforts are being put in this direction to make these trade-offs application-centric.

2) Robustness

- a) A system that works repetitively without too much hassle is the need of the time. Therefore, the robustness of the DGS-based WPT systems is another aspect that must be the focus in the near future. Specifically, different types of misalignment between T_X and R_X such as angular, horizontal, and vertical can degrade the WPT system performance considerably. New methodologies are required to account for these issues and provide robustness to the WPT systems.

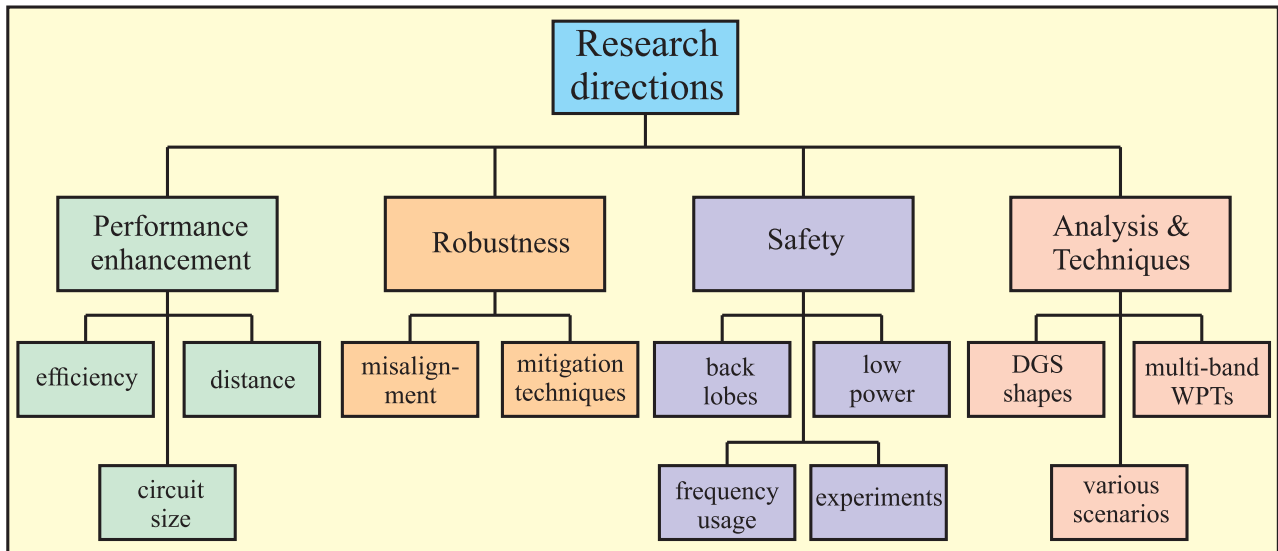

FIGURE 11. The research directions in the domain of the DGS-based WPT systems.

- b) It is often reported that a disagreement occurs between the simulation and experimental results in such systems. Thus, there is a pressing need to develop a new methodology, such as integrated hardware in the loop type solution, that can mitigate this issue.
- 3) Safety
- a) One of the main applications of the near-field WPT systems relates to the broad biomedical domain. In this context, the safety aspect is paramount as it concerns the use and handles by a human for humans. The idea here should be to avoid any adverse impact on human health. It is important to mention that the existing solutions have not considered this issue but it is pertinent to investigate this further so as to develop techniques for reducing the back-lobe radiations of the resonators.
 - b) The high-power WPT systems may not be appropriate for numerous applications including IMDs, for safety reasons, and, in such cases, the low-power near-field WPT systems are mostly employed. Hence, the innovative WPT systems with extremely high efficiency are the need of the time.
 - c) Most of the existing works report the designs operating at arbitrary frequencies but these may not be very appropriate for the biomedical domain considering that it concerns human health. Accordingly, future research should consider only the Federal Communications Commission (FCC) approved reserved frequency bands as it helps to standardize the concerns associated with the WPT systems employed in the biomedical field.
 - d) It is worthwhile mentioning that the available literature still lacks the reports considering the performance of the DGS-based WPT system in the real tissue environment. Consequently, more experiments and explorations of power transfer through biological tissues are needed.
- 4) Design and Analysis Techniques
- a) So far, the existing solutions have been relied on introducing different-shaped defects on the ground plane to achieve the desired resonant frequency and obtain high Q . It has been demonstrated in Section III-B through the case studies that different shapes possess almost the same Q . Besides, the varying resonant frequency can be tuned using an external capacitor. Accordingly, this approach can be definitely considered as a sub-optimal design process. Therefore, to further advance the design approaches, the focus should not be on various shapes but on the development of some techniques based on quasi-static equivalent circuits. Furthermore, there is a need to support designs through closed-form equations relating to M and k for achieving scalability and repeatability. This will eventually assist in the overall planning of the desired WPT system prior to starting the eventual design.
 - b) Besides, new techniques to design the compact multi-band WPT systems with excellent performance have the potential to bring a paradigm shift in a broad range of the internet of things (IoT) devices and, therefore, should be prioritized.
 - c) Other design scenarios that have the potential to enhance the power transfer range and improve other design metrics that should also be considered. For example, a multi-hop scenario, *i.e.*,

placing an intermediate resonator between T_X and R_X , seems a good direction to pursue advanced research as it may provide a huge improvement in terms of d .

VI. CONCLUSION

This paper provides a comprehensive resource about the challenges and recent advancements in the domain of the DGS-based WPT systems. Analysis of the different examined DGS shapes shows that the average Q value can be obtained by utilizing any of them. Although this field has been advancing in the last several years this area still needs some research considerations, e.g., human safety aspects, new design techniques, different analyses, etc. In addition, the provided review reveals that the WPT systems have been broadened to the multi-band structures enabling the system to transfer power and data simultaneously.

REFERENCES

- [1] W. Man Ng, C. Zhang, D. Lin, and S. Y. Ron Hui, "Two- and three-dimensional omnidirectional wireless power transfer," *IEEE Trans. Power Electron.*, vol. 29, no. 9, pp. 4470–4474, Sep. 2014.
- [2] M.-L. Kung and K.-H. Lin, "Dual-band coil module with repeaters for diverse wireless power transfer applications," *IEEE Trans. Microw. Theory Techn.*, vol. 66, no. 1, pp. 332–345, Jan. 2018.
- [3] O. Jonah and S. V. Georgakopoulos, "Wireless power transfer in concrete via strongly coupled magnetic resonance," *IEEE Trans. Antennas Propag.*, vol. 61, no. 3, pp. 1378–1384, Mar. 2013.
- [4] H. Hertz, *Dictionary of Scientific Biography*, vol. 6. New York, NY, USA: Scribner, 1981, pp. 340–349.
- [5] W. C. Brown, "The history of power transmission by radio waves," *IEEE Trans. Microw. Theory Techn.*, vol. MTT-32, no. 9, pp. 1230–1242, Sep. 1984.
- [6] N. Tesla, "Apparatus for transmitting electrical energy," U.S. Patent 1 119 732 A, Dec. 1, 1914.
- [7] N. Tesla, "The true wireless," *Electr. Experimenter*, vol. 4, no. 5, pp. 28–34, May 1919.
- [8] N. Shinohara, *Wireless Power Transfer via Radiowaves*. London, U.K.: Wiley, 2014, ch. 1, pp. 1–12.
- [9] D. Belo, D. C. Ribeiro, P. Pinho, and N. Borges Carvalho, "A selective, tracking, and power adaptive far-field wireless power transfer system," *IEEE Trans. Microw. Theory Techn.*, vol. 67, no. 9, pp. 3856–3866, Sep. 2019.
- [10] J. Garnica, R. A. Chinga, and J. Lin, "Wireless power transmission: From far field to near field," *Proc. IEEE*, vol. 101, no. 6, pp. 1321–1331, Jun. 2013.
- [11] M.-L. Kung and K.-H. Lin, "Enhanced analysis and design method of dual-band coil module for near-field wireless power transfer systems," *IEEE Trans. Microw. Theory Techn.*, vol. 63, no. 3, pp. 821–832, Mar. 2015.
- [12] J. O. McSpadden and J. C. Mankins, "Space solar power programs and microwave wireless power transmission technology," *IEEE Microw. Mag.*, vol. 3, no. 4, pp. 46–57, Dec. 2002.
- [13] J. Xu, Y. Zeng, and R. Zhang, "UAV-enabled wireless power transfer: Trajectory design and energy optimization," *IEEE Trans. Wireless Commun.*, vol. 17, no. 8, pp. 5092–5106, Aug. 2018.
- [14] I. Ghotbi, M. Najjarzadegan, H. Sarfaraz, S. Jafarabadi Ashtiani, and O. Shoaei, "Enhanced Power-Delivered-to-Load through planar multiple-harmonic wireless power transmission," *IEEE Trans. Circuits Syst. II, Exp. Briefs*, vol. 65, no. 9, pp. 1219–1223, Sep. 2018.
- [15] M. Kiani and M. Ghovanloo, "An RFID-based closed-loop wireless power transmission system for biomedical applications," *IEEE Trans. Circuits Syst. II, Exp. Briefs*, vol. 57, no. 4, pp. 260–264, Apr. 2010.
- [16] M. Zargham and P. G. Gulak, "Fully integrated on-chip coil in 0.13 μm CMOS for wireless power transfer through biological media," *IEEE Trans. Biomed. Circuits Syst.*, vol. 9, no. 2, pp. 259–271, Apr. 2015.
- [17] G. Wang, P. Wang, Y. Tang, and W. Liu, "Analysis of dual band power and data telemetry for biomedical implants," *IEEE Trans. Biomed. Circuits Syst.*, vol. 6, no. 3, pp. 208–215, Jun. 2012.
- [18] C.-J. Chen, T.-H. Chu, C.-L. Lin, and Z.-C. Jou, "A study of loosely coupled coils for wireless power transfer," *IEEE Trans. Circuits Syst. II, Exp. Briefs*, vol. 57, no. 7, pp. 536–540, Jul. 2010.
- [19] F. Tahar, A. Barakat, R. Saad, K. Yoshitomi, and R. K. Pokharel, "Dual-band defected ground structures wireless power transfer system with independent external and inter-resonator coupling," *IEEE Trans. Circuits Syst. II, Exp. Briefs*, vol. 64, no. 12, pp. 1372–1376, Dec. 2017.
- [20] B. L. Cannon, J. F. Hoburg, D. D. Stancil, and S. C. Goldstein, "Magnetic resonant coupling as a potential means for wireless power transfer to multiple small receivers," *IEEE Trans. Power Electron.*, vol. 24, no. 7, pp. 1819–1825, Jul. 2009.
- [21] F. Jolani, Z. Chen, and Y. Yu, "Enhanced planar wireless power transfer using strongly coupled magnetic resonance," *Electron. Lett.*, vol. 51, no. 2, pp. 173–175, Jan. 2015.
- [22] F. Jolani, Y. Yu, and Z. Chen, "A planar magnetically coupled resonant wireless power transfer system using printed spiral coils," *IEEE Antennas Wireless Propag. Lett.*, vol. 13, pp. 1648–1651, Aug. 2014.
- [23] M. Mohamed, M. Cheffena, A. Moldsvor, and F. P. Fontan, "Physical-statistical channel model for off-body area network," *IEEE Antennas Wireless Propag. Lett.*, vol. 16, pp. 1516–1519, 2017.
- [24] D. Rano and M. Hashmi, "Extremely compact EBG-backed antenna for smartwatch applications in medical body area network," *IET Microw. Antennas Propag.*, vol. 13, no. 7, pp. 1031–1040, Jun. 2019.
- [25] Z. Ling, F. Hu, L. Wang, J. Yu, and X. Liu, "Point-to-Point wireless information and power transfer in WBAN with energy harvesting," *IEEE Access*, vol. 5, pp. 8620–8628, 2017.
- [26] J. Huh, S. W. Lee, W. Y. Lee, G. H. Cho, and C. T. Rim, "Narrow-width inductive power transfer system for online electrical vehicles," *IEEE Trans. Power Electron.*, vol. 26, no. 12, pp. 3666–3679, Dec. 2011.
- [27] Y.-C. Hsieh, Z.-R. Lin, M.-C. Chen, H.-C. Hsieh, Y.-C. Liu, and H.-J. Chiu, "High-efficiency wireless power transfer system for electric vehicle applications," *IEEE Trans. Circuits Syst. II, Exp. Briefs*, vol. 64, no. 8, pp. 942–946, Aug. 2017.
- [28] Y. Jia, S. A. Mirbozorgi, Z. Wang, C.-C. Hsu, T. E. Madsen, D. Rainnie, and M. Ghovanloo, "Position and orientation insensitive wireless power transmission for EnerCage-homecare system," *IEEE Trans. Biomed. Eng.*, vol. 64, no. 10, pp. 2439–2449, Oct. 2017.
- [29] H. Mei, K. A. Thackston, R. A. Bercich, J. G. R. Jefferys, and P. P. Irazoqui, "Cavity resonator wireless power transfer system for freely moving animal experiments," *IEEE Trans. Biomed. Eng.*, vol. 64, no. 4, pp. 775–785, Apr. 2017.
- [30] D. K. Freeman and S. J. Byrnes, "Optimal frequency for wireless power transmission into the body: Efficiency versus received power," *IEEE Trans. Antennas Propag.*, vol. 67, no. 6, pp. 4073–4083, Jun. 2019.
- [31] U.-M. Jow and M. Ghovanloo, "Design and optimization of printed spiral coils for efficient transcutaneous inductive power transmission," *IEEE Trans. Biomed. Circuits Syst.*, vol. 1, no. 3, pp. 193–202, Sep. 2007.
- [32] Y. Zhang, Z. Zhao, and K. Chen, "Frequency-splitting analysis of four-coil resonant wireless power transfer," *IEEE Trans. Ind. Appl.*, vol. 50, no. 4, pp. 2436–2445, Jul. 2014.
- [33] S. Yu, H. Liu, and L. Li, "Design of near-field focused metasurface for high-efficient wireless power transfer with multifocus characteristics," *IEEE Trans. Ind. Electron.*, vol. 66, no. 5, pp. 3993–4002, May 2019.
- [34] P. Zhang, L. Li, X. Zhang, H. Liu, and Y. Shi, "Design, measurement and analysis of near-field focusing reflective metasurface for dual-polarization and multi-focus wireless power transfer," *IEEE Access*, vol. 7, pp. 110387–110399, 2019.
- [35] L. Li, H. Liu, H. Zhang, and W. Xue, "Efficient wireless power transfer system integrating with metasurface for biological applications," *IEEE Trans. Ind. Electron.*, vol. 65, no. 4, pp. 3230–3239, Apr. 2018.
- [36] C. Liu, A. P. Hu, and N.-K.-C. Nair, "Modelling and analysis of a capacitively coupled contactless power transfer system," *IET Power Electron.*, vol. 4, no. 7, pp. 808–815, Aug. 2011.
- [37] L. Li, X. Zhang, C. Song, and Y. Huang, "Progress, challenges, and perspective on metasurfaces for ambient radio frequency energy harvesting," *Appl. Phys. Lett.*, vol. 116, no. 6, Feb. 2020, Art. no. 060501.
- [38] C.-Y. Liou, C.-J. Kuo, and S.-G. Mao, "Wireless-Power-Transfer system using near-field capacitively coupled resonators," *IEEE Trans. Circuits Syst. II, Exp. Briefs*, vol. 63, no. 9, pp. 898–902, Sep. 2016.
- [39] P. S. Riehl, A. Satyamoorthy, H. Akram, Y.-C. Yen, J.-C. Yang, B. Juan, C.-M. Lee, F.-C. Lin, V. Muratov, W. Plumb, and P. F. Tustin, "Wireless power systems for mobile devices supporting inductive and resonant operating modes," *IEEE Trans. Microw. Theory Techn.*, vol. 63, no. 3, pp. 780–790, Mar. 2015.

- [40] A. Kurs, A. Karalis, R. Moffatt, J. D. Joannopoulos, P. Fisher, and M. Soljacic, "Wireless power transfer via strongly coupled magnetic resonances," *Science*, vol. 317, no. 5834, pp. 83–86, Jul. 2007.
- [41] X. Lu, P. Wang, D. Niyato, D. I. Kim, and Z. Han, "Wireless charging technologies: Fundamentals, standards, and network applications," *IEEE Commun. Surveys Tuts.*, vol. 18, no. 2, pp. 1413–1452, 2nd Quart., 2016.
- [42] H.-J. Kim, H. Hirayama, S. Kim, K. J. Han, R. Zhang, and J.-W. Choi, "Review of near-field wireless power and communication for biomedical applications," *IEEE Access*, vol. 5, pp. 21264–21285, 2017.
- [43] J. Wang, J. Li, S. L. Ho, W. Y. Chau, W. K. Lee, W. N. Fu, Y. Li, H. Yu, and M. Sun, "Study and experimental verification of a rectangular Printed-Circuit-Board wireless transfer system for low power devices," *IEEE Trans. Magn.*, vol. 48, no. 11, pp. 3013–3016, Nov. 2012.
- [44] M. M. Falavarjani, J. Rashed-Mohassel, and M. Shahabadi, "Design and implementation of compact WPT system using printed spiral resonators," *Electron. Lett.*, vol. 50, no. 2, pp. 110–111, Jan. 2014.
- [45] S. D. Barman, A. W. Reza, N. Kumar, M. E. Karim, and A. B. Munir, "Wireless powering by magnetic resonant coupling: Recent trends in wireless power transfer system and its applications," *Renew. Sustain. Energy Rev.*, vol. 51, pp. 1525–1552, Nov. 2015.
- [46] S. Y. R. Hui, W. Zhong, and C. K. Lee, "A critical review of recent progress in mid-range wireless power transfer," *IEEE Trans. Power Electron.*, vol. 29, no. 9, pp. 4500–4511, Sep. 2014.
- [47] N. Shinohara, "Power without wires," *IEEE Microw. Mag.*, vol. 12, no. 7, pp. S64–S73, Dec. 2011.
- [48] S. Hekal and A. B. Abdel-Rahman, "New compact design for short range wireless power transmission at 1GHz using H-slot resonators," in *Proc. 9th Eur. Conf. Antennas Propag. (EuCAP)*, Lisbon, Portugal, Apr. 2015, pp. 1–5.
- [49] S. Hekal, A. B. Abdel-Rahman, H. Jia, A. Allam, A. Barakat, T. Kaho, and R. K. Pokharel, "Compact wireless power transfer system using defected ground bandstop filters," *IEEE Microw. Wireless Compon. Lett.*, vol. 26, no. 10, pp. 849–851, Oct. 2016.
- [50] D. Liu, H. Hu, and S. V. Georgakopoulos, "Misalignment sensitivity of strongly coupled wireless power transfer systems," *IEEE Trans. Power Electron.*, vol. 32, no. 7, pp. 5509–5519, Jul. 2017.
- [51] J. Lee, Y.-S. Lim, W.-J. Yang, and S.-O. Lim, "Wireless power transfer system adaptive to change in coil separation," *IEEE Trans. Antennas Propag.*, vol. 62, no. 2, pp. 889–897, Feb. 2014.
- [52] S. Raju, R. Wu, M. Chan, and C. P. Yue, "Modeling of mutual coupling between planar inductors in wireless power applications," *IEEE Trans. Power Electron.*, vol. 29, no. 1, pp. 481–490, Jan. 2014.
- [53] F. Mastri, A. Costanzo, and M. Mongiardo, "Coupling-independent wireless power transfer," *IEEE Microw. Wireless Compon. Lett.*, vol. 26, no. 3, pp. 222–224, Mar. 2016.
- [54] L. Li, K. Ma, and S. Mou, "Modeling of new spiral inductor based on substrate integrated suspended line technology," *IEEE Trans. Microw. Theory Techn.*, vol. 65, no. 8, pp. 2672–2680, Aug. 2017.
- [55] D. Ahn and P. Mercier, "Wireless power transfer with concurrent 200 kHz and 6.78 MHz operation in a single transmitter device," *IEEE Trans. Power Electron.*, vol. 31, no. 7, pp. 5018–5029, Jul. 2016.
- [56] M. Ghovanloo and S. Atluri, "A wide-band power-efficient inductive wireless link for implantable microelectronic devices using multiple carriers," *IEEE Trans. Circuits Syst. I, Reg. Papers*, vol. 54, no. 10, pp. 2211–2221, Oct. 2007.
- [57] S. Hekal, A. B. Abdel-Rahman, H. Jia, A. Allam, A. Barakat, and R. K. Pokharel, "A novel technique for compact size wireless power transfer applications using defected ground structures," *IEEE Trans. Microw. Theory Techn.*, vol. 65, no. 2, pp. 591–599, Feb. 2017.
- [58] J. Lim, B. Lee, and M. Ghovanloo, "Optimal design of a resonance-based voltage boosting rectifier for wireless power transmission," *IEEE Trans. Ind. Electron.*, vol. 65, no. 2, pp. 1645–1654, Feb. 2018.
- [59] A. K. Ramrakhiani and G. Lazzi, "On the design of efficient multi-coil telemetry system for biomedical implants," *IEEE Trans. Biomed. Circuits Syst.*, vol. 7, no. 1, pp. 11–23, Feb. 2013.
- [60] D. Ahn and M. Ghovanloo, "Optimal design of wireless power transmission links for millimeter-sized biomedical implants," *IEEE Trans. Biomed. Circuits Syst.*, vol. 10, no. 1, pp. 125–137, Feb. 2016.
- [61] X. Lou and G.-M. Yang, "A dual linearly polarized rectenna using defected ground structure for wireless power transmission," *IEEE Microw. Wireless Compon. Lett.*, vol. 28, no. 9, pp. 828–830, Sep. 2018.
- [62] S. Verma, D. Rano, M. Hashmi, and V. Bohara, "A high Q dual E-Shaped defected ground structure for wireless power transfer applications," in *Proc. Asia-Pacific Microw. Conf. (APMC)*, Kyoto, Japan, Nov. 2018, pp. 1435–1437.
- [63] S. Chalise, F. Tahar, M. R. Saad, A. Baraket, K. Yoshitomi, and R. K. Pokharel, "High efficiency wireless power transfer system using spiral DGS resonators through biological tissues," in *Proc. IEEE Int. Microw. Biomed. Conf. (IMBioC)*, Philadelphia, PA, USA, Jun. 2018, pp. 43–45.
- [64] K. Dautov, R. Gupta, and M. Hashmi, "A performance enhanced dual-band wireless power transfer system for practical ISM bands," in *Proc. IEEE Asia-Pacific Microw. Conf. (APMC)*, Dec. 2019, pp. 1259–1261.
- [65] S. Verma, D. Rano, and M. Hashmi, "A novel dual band defected ground structure for short range wireless power transfer applications," in *Proc. IEEE Wireless Power Transf. Conf. (WPTC)*, Jun. 2019, pp. 1–4.
- [66] N. C. Karmakar, S. M. Roy, and I. Balbin, "Quasi-static modeling of defected ground structure," *IEEE Trans. Microw. Theory Techn.*, vol. 54, no. 5, pp. 2160–2168, May 2006.
- [67] S. Hekal, A. B. Abdel-Rahman, A. Allam, A. Barakat, H. Jia, and R. K. Pokharel, "Asymmetric strongly coupled printed resonators for wireless charging applications," in *Proc. IEEE 17th Annu. Wireless Microw. Technol. Conf. (WAMICON)*, Apr. 2016, pp. 1–5.
- [68] D. Kupreyev, K. Dautov, M. Hashmi, and S. Verma, "Design of a compact DGS based dual-band RF WPT system for low-power applications," *IEEE Asia-Pacific Conf. Antennas Propag.*, Incheon, South Korea, Aug. 2019, pp. 1–2.
- [69] A. Barakat, K. Yoshitomi, and R. K. Pokharel, "Design approach for efficient wireless power transfer systems during lateral misalignment," *IEEE Trans. Microw. Theory Techn.*, vol. 66, no. 9, pp. 4170–4177, Sep. 2018.
- [70] A. Barakat, S. Alshhawy, K. Yoshitomi, and R. K. Pokharel, "Triple-band near-field wireless power transfer system using coupled defected ground structure band stop filters," in *IEEE MTT-S Int. Microw. Symp. Dig.*, Boston, MA, USA, Jun. 2019, pp. 1411–1414.
- [71] F. Tahar, R. Saad, A. Barakat, and R. K. Pokharel, "1.06 FoM and compact wireless power transfer system using rectangular defected ground structure resonators," *IEEE Microw. Wireless Compon. Lett.*, vol. 27, no. 11, pp. 1025–1027, Nov. 2017.
- [72] K. Dautov, M. Hashmi, S. Verma, and R. Gupta, "Highly-efficient Compact Size DGS-based Wireless Power Transfer for Low-Power Sensor Nodes," *IEEE MTT-S Int. Microw. RF Conf. (IMARC)*, Mumbai, India, pp. 1–3, Dec. 2019.
- [73] A. Barakat, K. Yoshitomi, and R. K. Pokharel, "Design and implementation of dual-mode inductors for dual-band wireless power transfer systems," *IEEE Trans. Circuits Syst. II, Exp. Briefs*, vol. 66, no. 8, pp. 1287–1291, Aug. 2019.
- [74] R. Sharaf, A. B. Abdel-Rahman, A. S. Abd El-Hameed, A. Barakat, S. Hekal, and A. Allam, "A new compact dual-band wireless power transfer system using interlaced resonators," *IEEE Microw. Wireless Compon. Lett.*, vol. 29, no. 7, pp. 498–500, Jul. 2019.
- [75] J.-S. Lim, Y.-T. Lee, C.-S. Kim, D. Ahn, and S. Nam, "A vertically periodic defected ground structure and its application in reducing the size of microwave circuits," *IEEE Microw. Wireless Compon. Lett.*, vol. 12, no. 12, pp. 479–481, Dec. 2002.
- [76] S. Ying Huang and Y. Hui Lee, "A compact E-Shaped patterned ground structure and its applications to tunable bandstop resonator," *IEEE Trans. Microw. Theory Techn.*, vol. 57, no. 3, pp. 657–666, Mar. 2009.
- [77] C.-S. Kim, J.-S. Park, D. Ahn, and J.-B. Lim, "A novel 1-D periodic defected ground structure for planar circuits," *IEEE Microw. Guided Wave Lett.*, vol. 10, no. 4, pp. 131–133, Apr. 2000.
- [78] D. Ahn, J.-S. Park, C.-S. Kim, J. Kim, Y. Qian, and T. Itoh, "A design of the low-pass filter using the novel microstrip defected ground structure," *IEEE Trans. Microw. Theory Techn.*, vol. 49, no. 1, pp. 86–93, Jan. 2001.
- [79] M. K. Mandal and S. Sanyal, "A novel defected ground structure for planar circuits," *IEEE Microw. Wireless Compon. Lett.*, vol. 16, no. 2, pp. 93–95, Feb. 2006.
- [80] A. Abdel-Rahman, A. K. Verma, A. Boutejdar, and A. S. Omar, "Compact stub type microstrip bandpass filter using defected ground plane," *IEEE Microw. Wireless Compon. Lett.*, vol. 14, no. 4, pp. 136–138, Apr. 2004.
- [81] H.-W. Liu, Z.-F. Li, X.-W. Sun, and J.-F. Mao, "An improved 1D periodic defected ground structure for microstrip line," *IEEE Microw. Wireless Compon. Lett.*, vol. 14, no. 4, pp. 180–182, Apr. 2004.
- [82] D.-J. Woo, T.-K. Lee, J.-W. Lee, C.-S. Pyo, and W.-K. Choi, "Novel U-slot and V-slot DGSs for bandstop filter with improved Q factor," *IEEE Trans. Microw. Theory Techn.*, vol. 54, no. 6, pp. 2840–2847, Jun. 2006.

- [83] H. Liu, Z. Li, and X. Sun, "Compact defected ground structure in microstrip technology," *Electron. Lett.*, vol. 41, no. 3, pp. 132–134, 3 Feb. 2005.
- [84] X.-H. Wang, B.-Z. Wang, H. Zhang, and K. J. Chen, "A tunable bandstop resonator based on a compact slotted ground structure," *IEEE Trans. Microw. Theory Techn.*, vol. 55, no. 9, pp. 1912–1918, Sep. 2007.
- [85] C. Kumar and D. Guha, "Asymmetric geometry of defected ground structure for rectangular microstrip: A new approach to reduce its cross-polarized fields," *IEEE Trans. Antennas Propag.*, vol. 64, no. 6, pp. 2503–2506, Jun. 2016.
- [86] T. Imura and Y. Hori, "Maximizing air gap and efficiency of magnetic resonant coupling for wireless power transfer using equivalent circuit and neumann formula," *IEEE Trans. Ind. Electron.*, vol. 58, no. 10, pp. 4746–4752, Oct. 2011.



KASSEN DAUTOV received the B.Sc. degree (Hons.) in radio engineering, electronics and telecommunications from Kazakh National Research Technical University after K. I. Satpayev, Almaty, Kazakhstan, in 2009, and the M.Sc. degree in electronics engineering from the Bremen University of Applied Sciences, Bremen, Germany, in 2015. He is currently pursuing the Ph.D. degree in science, engineering, and technology with Nazarbayev University, Nur-Sultan,

Kazakhstan. His research interests include broad areas of an antenna and high-frequency circuit design, with particular focus on wireless power transfer systems, energy harvesting, and the antennas utilized in wireless body area networks.



MOHAMMAD HASHMI (Senior Member, IEEE) received the B.Tech. degree from Aligarh Muslim University, India, the M.S. degree from the Darmstadt University of Technology, Germany, and the Ph.D. degree from Cardiff University, Cardiff, U.K. He had held research and engineering positions at the University of Calgary, Canada; Cardiff University; Thales Electronics GmbH, Germany; and Philips Technology Centre, Germany. He is currently an Associate Professor

with Nazarbayev University, Kazakhstan, and also holds a faculty position at IIT Delhi, India. His current research interests include in the domain of advanced RF circuits for wireless applications (including wireless power transfer and energy harvesting), broadband linear and efficient power amplifiers for mobile and satellite applications, and high- and low-frequency instrumentation. His research activities have led to one book, three U.S. patents (two pending), and over 180 journal and conference publications. He is also an Associate Editor of the *IEEE Microwave Magazine*.



GALYMZHAN NAURYZBAYEV (Member, IEEE) received the B.Sc. and M.Sc. degrees (Hons.) in radio engineering, electronics, and telecommunications from the Almaty University of Power Engineering and Telecommunication, Almaty, Kazakhstan, in 2009 and 2011, respectively, and the Ph.D. degree in wireless communications from The University of Manchester, U.K., in 2016. From 2016 to 2018, he held several academic and research positions at Nazarbayev University,

Kazakhstan; L. N. Gumilyov Eurasian National University, Kazakhstan; and Hamad Bin Khalifa University, Qatar. In 2019, he joined Nazarbayev University as an Assistant Professor. His research interest is in the area of wireless communication systems, with particular focus on multiuser MIMO systems, cognitive radio, signal processing, energy harvesting, visible light communications, NOMA, interference mitigation, and so on. He served as a technical program committee member on numerous IEEE flagship conferences.



N. NASIMUDDIN (Senior Member, IEEE) received the B.Sc. degree in New Delhi, India, in 1994, and the M.Tech. degree in microwave electronics and the Ph.D. degree from the University of Delhi, India, in 1998 and 2004, respectively. From 1999 to 2003, he has worked as a Senior Research Fellow in DST sponsored project on Optical Control of Passive Microwave Devices and Council of Scientific and Industrial Research (CSIR), Government of India, a Senior Research

Fellowship in engineering science for the project entitled Investigations of Microstrip Antennas as a Sensor for Determination of Complex Dielectric Constant of Materials at the Department of Electronic Science, University of Delhi. From 2004 to 2006, he has also worked as an Australian Postdoctoral Research Fellow in awarded Discovery project grant from the Australian Research Council for the project entitled Microwave Sensor Based on Multilayered Microstrip Patch/Line Resonators at Macquarie University, Australia. He is currently a Scientist with the Institute for Infocomm Research, A*STAR, Singapore. He has published 185 journal and conference technical articles on microstrip-based microwave antennas and components. He has edited and contributed a chapter to a book *Microstrip Antennas* (InTech, 2011). He has been filed five antenna patent applications and several antenna technologies licenses to companies. His research interests include multilayered microstrip-based structures, millimeter-wave antennas, radio-frequency identification reader antennas, global positioning system/global navigation satellite system, ultrawideband antennas, metamaterials-based microstrip antennas, beamforming/beam-steering antennas, satellite antennas, RF energy harvesting systems, circularly polarized microstrip antennas, and small antennas for TV white space communications.

Dr. Nasimuddin is a Senior Member of the IEEE Antennas and Propagation Society and an Executive Committee Member of the IEEE MTT/AP Chapter/CRFID Chapter Singapore. He has also been an organizing committee member of international/national conferences related to antenna and propagation. He was awarded a Senior Research Fellowship from the Council of Scientific and Industrial Research, Government of India in Engineering Science, from 2001 to 2003, a Discovery Projects Fellowship from the Australian Research Council, from 2004 to 2006, the Singapore Manufacturing Federation Award (with project team), in 2014, and the Young Scientist Award from the International Union of Radio Science (URSI), in 2005.

• • •