

Received January 15, 2020, accepted February 4, 2020, date of publication February 28, 2020, date of current version March 19, 2020.

Digital Object Identifier 10.1109/ACCESS.2020.2977115

# Review and Investigation of Simplified Rules Fuzzy Logic Speed Controller of High Performance Induction Motor Drives

QAZWAN A. TARBOSH<sup>1,2</sup>, ÖMER AYDOĞDU<sup>1</sup>, NABIL FARAH<sup>3</sup>,  
MD HAIRUL NIZAM TALIB<sup>3</sup>, ADEEB SALH<sup>4</sup>, NIHAT ÇANKAYA<sup>1,5</sup>,  
FUAD ALHAJ OMAR<sup>2</sup>, AND AKIF DURDU<sup>1</sup>

<sup>1</sup>Faculty of Engineering and Natural Sciences, Konya Technical University, 42250 Konya, Turkey

<sup>2</sup>Faculty of Electrical and Electronic Engineering, Selçuk University, 42250 Konya, Turkey

<sup>3</sup>Faculty of Electrical Engineering, Universiti Teknikal Malaysia Melaka, Durian Tunggal 76100, Malaysia

<sup>4</sup>Faculty of Electrical and Electronic Engineering, Universiti Tun Hussein Onn, Johor 86400, Malaysia

<sup>5</sup>Meram Vocational School, Necmettin Erbakan University, 42090 Konya, Turkey

Corresponding authors: Qazwan A. Tarbosh (gazwan20062015@gmail.com) and Nabil Farah (nabil-farah11@hotmail.com)

**ABSTRACT** The use of Fuzzy Logic Controller (FLC) as a speed controller for Induction Motor (IM) drives is garnering strong researchers' interest since it has proven to achieve superior performance compared to conventional controllers. The aim of this study is to review and investigate the design, operations, and effects of rules reduction for FLC in IM drives. Based on the literature, the most commonly used technique to design FLC Membership Functions (MFs) rule-base and control model is based on engineering skills and experienced behavioral aspects of the controlled system. Simplified fuzzy rules approaches have been introduced to reduce the number of fuzzy rules in order to realize hardware implementation. This study discusses different simplified rules methods applied to IM drives. Most of the proposed methods shared a common drawback in that they lacked systematic procedures for designing FLC rule base. Therefore, this research proposed a methodological approach to designing and simplifying the FLC rule-base for IM drives based on dynamic step response and phase plane trajectory of the second order representation of IM drives systems. The proposed method presents guidance for designing FLC rule-base based on the general dynamic step response of the controlled system. Following the proposed method procedures, a (9, 25, 49) rules size has been designed and simplified to a (5, 7, 9) rules size. The effectiveness and accuracy of the designed rules as well as the simplified rules were verified by conducting simulation analysis of IM drives using MATLAB/Simulink environment. Step speed command performance comparisons were achieved with both standard designed and simplified rules at various speed demands. The simulation results showed that the simplified rules maintain the drive performance and produced similar behavior as the standard designed rules.

**INDEX TERMS** FLC, IM drives, simplified rules, rule-base, step response, phase-plane, systematic.

## I. INTRODUCTION

High performance Induction Motor (IM) drives require a fast dynamic response, parameter variation robustness, disturbance rejection capabilities, and simple software and hardware implementation [1], [3]. Field Oriented Control (FOC) [4], Direct Torque Control (DTC) [5], and Model Predictive Control (MPC) [6] are the most commonly used control methods for high performance IM drives [7].

The associate editor coordinating the review of this manuscript and approving it for publication was Sing Kiong Nguang<sup>id</sup>.

Speed performance effectiveness is very important for reliability in IM drives. Commonly, the Proportional Integral (PI) controller is implemented as the speed controller in AC motor drives, which have been reported to obtain a fast transient response and good steady state response [8], [10]. However, PI controller is usually sensitive to motor parameters variation, system non-linearity, load disturbance, and speed variations, which consequently degrade drive performance [11], [12]. Therefore, the Fuzzy Logic Controller (FLC) was proposed as an adaptive controller to replace PI controller since it has less sensitivity to parameters

variation, non-linearity handling, load disturbance rejection capabilities, and robustness to speed variation. These features of FLC have made it the main choice for high performance IM drives [13], [15].

Over the last few decades, FLC has been the dominant speed controller for IM drives which obtain quick dynamic response and superior steady state response [16], [17]. FLC compensates for speed error based on expert designed Membership Function (MF) and fuzzy rules. There are three different MFs rules normally implemented for IM drives:  $7 \times 7$  MFs with 49 rules,  $5 \times 5$  MFs with 25 rules, and  $3 \times 3$  MFs with 9 rules. The number of MFs and FLC rules size has a direct impact on drive performance. As the number of MFs and rules size increased, good coverage of the fuzzy variables is obtained. Hence, IM drives perform well in specific system operations [18], [19]. The influence of rules size on drive performance has been investigated by different researchers, Betin *et al.* [20] who discussed the influence of rules size on the performance of stepping motors by implementing the 9, 25, 49 rules size and the 81 rules size. The author concluded that the best drive performance was obtained with the 49 rules size, and no improvement was made by increasing the rules size to 81. In addition, Kumar-*et al.* [18] applied three different rules sizes (9, 25, 49) to IM drives and reported that 49 rules produced the best performance during simulation testing, although a big computational burden was generated during hardware testing. Other studies have also verified the superiority of FLC with larger rules size over FLC with lesser rules size for IM drives [21], [25].

Big fuzzy rules size might enhance AC motor drives performance, especially during simulation, testing. However, a high computational burden was produced during hardware testing. This result was in [26], where three different rules sizes (9, 25, 49) were applied to IM drives and compared experimentally in terms of performance and computational time. It was found that large fuzzy rules size (49) produced higher computational time than lesser fuzzy rules size (9) during experimental implementation. Therefore, the 9-rules fuzzy showed superior performance over 25 and 49-rule fuzzies. The computational time has a direct influence on motor drives system performance during real-time implementation since large sampling frequency and memory space are required [27].

Various studies have addressed the issues of computational burden and complexity of IM drive systems due to large fuzzy rules size and their influence on system performance [28], [29]. To overcome the computational burden of fuzzy rules in IM drives systems, various researchers have proposed different techniques that can reduce the computational requirements while maintaining drive performance. FLC simplification is one of the popular techniques that has been proposed in order to reduce computational requirements FLC. FLC model [30], includes a new FLC model designed with a mix of trapezoidal and triangular MFs for inputs, and output fuzzy variables due to their ease of

mathematical representation. This simplifies the implementation of the FLC interface engine and reduces the computational burden of the system in order to realize real-time implementation. In addition, another approach simplifies FLC inputs and outputs MFs, which as a result, reduce the number of fuzzy rules [31], [32]. However, this method affects fuzzy variables coverage and the accuracy of fuzzy output, hence performance degradation is expected.

Another method selects the dominant rules and omits the infrequent rules, resulting in fewer rules, while keeping the MFs constant [33], [36]. However, these studies select the dominant rules using ambiguous methods and did not employ systematic techniques to obtain their results. Because fuzzy systems work in a way similar to the human mind, the design of fuzzy rules has been a challenging task and mostly based on expert system operations. According to the literature, the use of FLC in IM drives systems has attributes that will allow it to replace the traditional PI controller [11], [37]. However, due to its associated high computational requirements, there are additional issues with experimental implementation and/or hardware costs [26], [27].

This paper reviews FLC design and simplification methods and proposes a new methodology to design and simplify FLC rule base. The paper is organized as follows: Section II discusses the history of FLC and its potential applications, Section III investigates IM drive systems, Section IV discusses FLC design and simplification methods, Section V discusses proposed FLC design and simplification techniques, Section VI presents a simulation analysis based on the proposed FLC rule-base, and Section VII summarizes the study and highlights the findings and outcomes of the study.

## II. HISTORY OF FUZZY LOGIC

Fuzzy Logic was first introduced in the early 1970's by Lotfi A. Zadeh [38], [39] who proposed the fundamentals of fuzzy sets. This invention led to great advancement in the control system where fuzzy logic imitates the human decision-making process. Later on 1975, Ebrahim Mamdani introduced the fuzzy inference system to control a steam engine and boiler by making linguistic synthesis control rules based on expert human operators [40]. He established the fundamentals of the currently used fuzzy interface system which involves fuzzification and defuzzification of crisp input variables to derive crisp output variables. The fuzzy interface system established by Mamdani had widespread acceptance and is still being used in current applications. A decade later, Takagi-Sugeno has introduced a new fuzzy interface system that works similarly to Mamdani's method except for the output membership function which has to be either linear or constant [41], [42]. The proposed method is compact and computationally efficient, because it utilizes constant/linear output membership functions which can generate an offline table, unlike the Mamdani type which generates an online lookup table, which increases the online computation capabilities of the fuzzy system. However, generating an offline table is time consuming and its accuracy may degrade system

performance. Both the Mamdani and Takagi-Sugeno methods have widespread interest in various disciplines [43], [44].

Over the past four decades, Fuzzy Logic Controller (FLC) based on Mamdani or Takagi-Sugeno fuzzy interface systems have gained widespread attraction in various industrial applications such as motor drives [45], power electronic converters [46], power systems [47] and many more [48], [49]. The aforementioned theories about fuzzy logic are considered to be type-1 fuzzy sets with two-dimensional membership functions that are precisely selected based on system experts [50]. However, another type of set, called a type-2 fuzzy set, utilizes three-dimensional membership functions that are themselves fuzzy [51]. These were first proposed by Zadeh [52] as an extension for the type-1 fuzzy sets introduced earlier [39]. Such fuzzy sets are suitable for systems whose membership functions are not exact and can be handled [50], [53]. Recently type-2 fuzzy sets have gained a lot of interests in motor drives application due to their adaptive nature in handling fuzzy rules [54], [57]. Despite the appealing features of type-2 fuzzy sets, they are not preferred for cost-sensitive real-time applications due to their extra high computational cost compared to type-1 fuzzy sets which require high capabilities processors, thus increasing the cost of application [58], [60]. In summary, the development of fuzzy logic systems has led to great advancement in control system applications. The ability of fuzzy systems to emulate human decision-making processes has made it a preferred controller in various industrial applications since it can handle system uncertainties, external disturbance, and parameters variations. With the development of different fuzzy systems, the Mamdani type-1 fuzzy sets interface system is the most popular and widely used fuzzy system, due to its design simplicity and performance accuracy compared to the Takagi-Sugeno interface system and lower computational requirements in comparison with type-2 fuzzy sets.

### III. IM DRIVE SYSTEM

Induction Motor (IM) is an AC motor which has a wide range of industrial and consumer applications because of its rugged construction, less maintenance, and reliability. Due to its intensive use in high power applications, IM requires a high performance drive system to efficiently and precisely control its operations [2]. Two popular high-performance IM drive methods are Field Oriented Control (FOC) [4] and Direct Torque Control (DTC) [5] which both work based on mathematical modeling of IM to drive their speed and/or torque. FOC works by decomposing torque and flux into DQ- frame and with the help of phase transformation and hysteresis control or space vector control, it can generate switching pulses for the inverter, DTC works by using two hysteresis flux and torque controllers to select the most appropriate voltage vector based on a predefined switching table in accordance with flux position and torque and flux error signals. Fig.1 shows a block diagram of IM drives system consisting of IM model, a speed controller, FOC or DTC drive method, and a Voltage Source Inverter (VSI) [7].

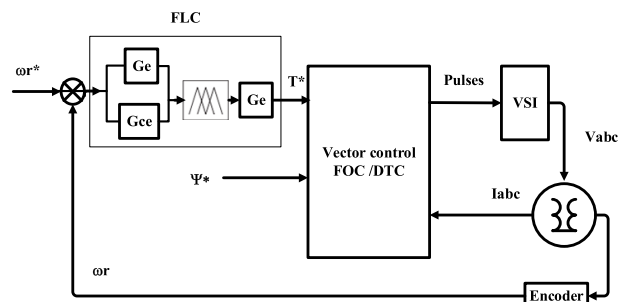

FIGURE 1. Block diagram of IM drive based FLC speed controller.

Induction Motor(IM) drive systems can be mathematically modeled in different reference frames such as stationary reference frame where the DQ-axis does not rotate, synchronous reference frame where the DQ-axis rotates at synchronous speeds or rotary reference frame where the DQ-axis rotates at rotor speed [61], [63]. The voltage equations of IM expressed in stationary reference frame are presented as follows:

$$V_{sd} = R_s I_{sd} + \frac{d\varphi_{sd}}{dt} \tag{1}$$

$$V_{sq} = R_s I_{sq} + \frac{d\varphi_{sq}}{dt} \tag{2}$$

$$V_{rd} = R_r I_{rd} + \frac{d\varphi_{rd}}{dt} - \omega_r \tag{3}$$

$$V_{rq} = R_r I_{rq} + \frac{d\varphi_{rq}}{dt} + \omega_r \varphi_{rd} \tag{4}$$

And the flux equations are expressed as follow:

$$\varphi_{sd} = L_s I_{sd} + L_m I_{rd} \tag{5}$$

$$\varphi_{sq} = L_s I_{sq} + L_m I_{rq} \tag{6}$$

$$\varphi_{rd} = L_m I_{sd} + L_r I_{rd} \tag{7}$$

$$\varphi_{rq} = L_m I_{sq} + L_r I_{rq} \tag{8}$$

where  $V_{sd}$ ,  $V_{sq}$  are the applied voltages to the stator; and  $I_{sd}$ ,  $I_{sq}$ ,  $I_{rd}$ ,  $I_{rq}$  are the corresponding d and q axis stator current and rotor currents.  $\varphi_{sd}$ ,  $\varphi_{sq}$ ,  $\varphi_{rd}$ ,  $\varphi_{rq}$  are the stator and rotor flux component.  $R_s$ ,  $R_r$  are the stator and rotor resistances.  $L_s$ ,  $L_r$  denotes stator and rotor inductances respectively, whereas  $L_m$  is the mutual inductance.

The space vector equations of the induction machine in the stationary reference frame can also be written in the matrix form in terms of their d-q components:

$$\begin{bmatrix} V_{qs} \\ V_{ds} \\ V_{qr} \\ V_{dr} \end{bmatrix} = \begin{bmatrix} R_s + sL_s & 0 & sL_m & 0 \\ 0 & R_s + sL_s & 0 & sL_m \\ sL_m & \omega_r L_m & R_r + sL_r & \omega_r L_r \\ -\omega_r L_m & sL_m & -\omega_r L_r & R_r + sL_r \end{bmatrix} \times \begin{bmatrix} i_{qs} \\ i_{ds} \\ i_{qr} \\ i_{dr} \end{bmatrix} \tag{9}$$

S term in equation (9) is Laplace operator which represents the derivative operator d/dt. The space vector equations can

also be put into state space forms with the choice of flux linkages or currents as state variables. If the stator and rotor currents are chosen as the state variables, re-arranging (9), the Induction Machine equation can be written as:

$$\begin{bmatrix} \dot{i}_{sd} \\ \dot{i}_{sq} \\ \dot{i}_{rd} \\ \dot{i}_{rq} \end{bmatrix} = \frac{1}{L_m^2 - L_r L_s} \times \begin{bmatrix} R_s L_r & -\omega_r L_m^2 i_{sq} & -R_r L_m & -\omega_r L_m L_r \\ \omega_r L_m^2 & R_s L_r & \omega_r L_m L_r & -R_r L_m \\ -R_s L_m & \omega_r L_m L_s & R_r L_s & \omega_r L_r L_s \\ -\omega_r L_m L_s & -R_s L_m & -\omega_r L_r L_s & R_r L_s \end{bmatrix} \times \frac{1}{L_m^2 - L_r L_s} \times \begin{bmatrix} -L_r & 0 \\ 0 & L_r \\ L_m & 0 \\ 0 & L_m \end{bmatrix} \times \begin{bmatrix} v_{sd} \\ v_{sq} \\ v_{rd} \\ v_{rq} \end{bmatrix} \quad (10)$$

Torque equation can be written into mechanical form as:

$$T_e = J \frac{d\omega_m}{dt} + B\omega_m + T_L = \frac{J}{P} \frac{d\omega_r}{dt} + \frac{B}{P}\omega_r + T_L \quad (11)$$

where,  $J$  is the total moment of inertia,  $B$  is the viscous friction,  $T_L$  is the load torque.  $\omega_r$  is the rotor electric angular speed in rad./s,  $\omega_m$  is the motor speed in rad/s.

Also, the torque equation can be written in electrical form as:

$$T_e = \frac{3}{2}P(\bar{\varphi}_s \bar{x}_s) = \frac{3}{2}P(\varphi_{sd} i_{sq} - \varphi_{sq} i_{sd}) \quad (12)$$

$$T_e = \frac{3}{2}PL_m(i_{sq} i_{rd} - i_{sd} i_{rq}) \quad (13)$$

where,  $P$  is the number of pole pairs for the induction machine?

#### IV. FUZZY LOGIC CONTROLLER (FLC)

Fuzzy Logic Controller (FLC) is an artificial intelligence controller that resembles human reasoning in controlling systems or operations. Based on Mamdani fuzzy sets [40], FLC consists of three stages: pre-processing, processing, and post-processing. In the pre-processing stage, crisp inputs are fuzzified and converted to fuzzy variables. In the processing stage, fuzzy inputs are interfaced based on designed fuzzy membership functions and rules to produce fuzzy output. In the post-processing stage, fuzzy outputs are defuzzified and converted again into crisp values to be used as control signals. The general FLC block diagram illustrating the-three stages is depicted in Fig. 2.

The block diagram in Fig. 2 shows the general form of FLC operations. But the rule-base and membership functions design depends on the nature of the system to be controlled. In the following sections, FLC design and simplification approaches are investigated.

As mentioned earlier, there are three different types of FLC systems [64]. Pure fuzzy system which has been introduced by Lotfi A. Zadeh [52], [39], Takagi-Sugeno (TS)

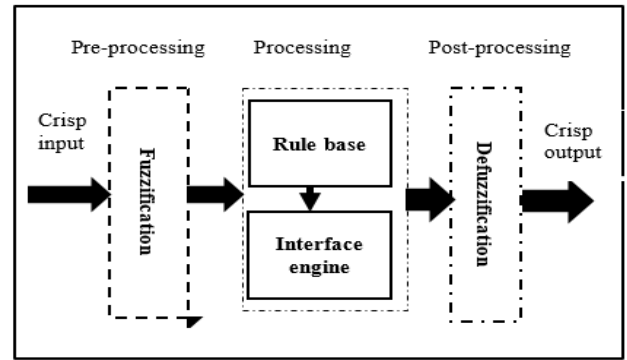

FIGURE 2. FLC operation stages block diagram.

system (TS) which has been proposed by Takagi and Sugeno [41], [65] and Mamdani or fuzzification-fuzzification system which has been proposed by Ebrahim Mamdani [40]. Pure fuzzy system is a combination of fuzzy rules that relates the inputs and the outputs of the system through a fuzzy interface engine based on the fuzzy logic concept. The inputs and outputs of the pure fuzzy system are fuzzy sets. However, the inputs and outputs of most engineering systems are crisp values which make it difficult to implement the pure fuzzy system in such applications. To overcome the limitations of pure fuzzy systems, Takagi-Sugeno (TS) system, which has real or crisp inputs and outputs, was proposed. TS outputs are obtained by a simple mathematical formula. However, since the outputs of the TS system are a mathematical formula, it may not provide a natural representation of human knowledge and there are many restrictions to apply various principles in fuzzy logic. Therefore, adoptability of fuzzy systems is limited with TS system. In order to overcome the issues associated with pure fuzzy and TS systems, the Mamdani or fuzzification-Defuzzification system was proposed which utilizes a fuzzifier to transform the crisp value inputs into fuzzy set inputs and a defuzzifier to transform the fuzzy set outputs into crisp value outputs. The differences between FLC types have been highlighted in [64], [66], [67]. Based on the mathematical functions of different FLC types, the Mamdani type is most widely used in engineering systems and best suited for hardware implementation. It is also known as standard FLC as presented in Fig. 2. This paper investigates fuzzy logic based on Mamdani FLC type.

#### A. FLC DESIGN

In order to investigate the components of FLC, a generic closed-loop control system was used. In closed-loop control systems the operator deals with the error ( $E$ ), which is the comparison resultant between a reference control target and actual control output [20], [68]. This explains the reasons why most FLCs utilize system error ( $E$ ) and change of error ( $\Delta E$ ) as their inputs-variables. Fuzzy systems imitate human reasoning, which is ambiguous, or fuzzy in nature. Therefore, FLC assigns its variables to partial membership sets or degrees of membership. The degree to which a variable



can vary is between 0 and 1, instead of being either 0 or 1 as in conventional logic. The fuzzy variables are linguistic variables which can be natural language words used to describe the values of those linguistic variables. These words are defined in the universe of discourse with membership functions (MFs) [64], [52]. There are many different shapes of MFs used in fuzzy systems such as Triangular, Trapezoidal, Gaussian, Sigmoid, and Singleton MFs. The simplest and most commonly used triangular MFs due to their simplicity and computational effectiveness [68].

The operation of FLC as shown in Fig.2 are fuzzification, which refers to the conversion of linguistic inputs variables into fuzzy sets with suitable MFs. These MFs are usually selected based on a comprehensive understanding of the physical behavior of the system to be controlled [27], [37]. The fuzzy rule-base is presented in the form of (IF-THEN) to describe the relationship between inputs and output variables in linguistic terms. An interface engine computes the overall value of the fuzzy control output based on the contribution of each fuzzy rule in the rule base. Lastly, defuzzification is applied, which converts the fuzzy output set from the interface engine to a single crisp output.

In this paper, only the rule-based design is considered for investigation, in which different fuzzy rule-based construction methods are reviewed. Fuzzy rules are usually represented in the form of (IF-THEN) due to its simplicity, widespread acceptance, and computational effectiveness [69]. The number of fuzzy rules relies on the total number of linguistic variables used in the system. For example, in closed-loop speed control of induction motor drives with two input and one output linguistic variables, a standard 9, 25, or 49 rules are used depending on the number of MFs [24], [26]. Various rule-based designs have been developed for FLC, however, there are there two popular methods commonly used to construct fuzzy rules. The first method, introduced by Mamdani, is referred to as the Heuristic Method, and utilizes control engineering knowledge and operator behavior modeling. Another method, proposed by Takagi-Sugeno, and referred to as the Deterministic Method, utilizes fuzzy modeling and a self-learning fuzzy controller [40], [41].

The Heuristic Method is widely used to construct fuzzy rule-based engineer knowledge and an expert operator. This is because, it requires engineering skills and system operation experience rather than system information [70]–[72]. The rule-base in the (IF-THEN) form and the Heuristic Method for closed-loop speed control of IM drives can be structured as follows:

$$\begin{array}{cccc}
 \text{Rule}_1 : & \text{IF } E \text{ is } A_1 \text{ and } \Delta E \text{ is } B_1, & \text{THEN } \Delta U \text{ is } C_1 & \\
 & \downarrow & \downarrow & \downarrow \\
 & \downarrow & \downarrow & \downarrow \\
 \text{Rule}_n : & \text{IF } E \text{ is } A_n \text{ and } \Delta E \text{ is } B_n, & \text{THEN } \Delta U \text{ is } C_n & 
 \end{array}$$

where ( $\text{Rule}_n$ ) is the  $n$ th fuzzy rule, ( $n$ ) is the number of fuzzy rules, ( $E$ ) and ( $\Delta E$ ) are input linguistic variables of error and

change of error, respectively, and ( $\Delta U$ ) is the output variable. ( $A_n$ ,  $B_n$ ) are input linguistic values for input variables ( $E$  or  $\Delta E$ ) and ( $C_n$ ) is the linguistic output values of output variable ( $\Delta U$ ).

The rule-base of FLC can be constructed using the Heuristic Method based on expert system operation and without mathematical modeling of the system. For instance, in IM speed control, the FLC rule-base can be constructed using the step response of the motor speed. The rules can be selected to increase or decrease the motor speed in order to follow a reference (desired) speed. This method has been implemented by many researchers [11], [19], [24], [26], [27], [37], [43], [66].

When constructing a rule-base for FLC, the rule-base must cover all possible situations that may be encountered by the system and there must be no conflicts between the rules. In other words, any designed rule-base for FLC should adhere to the properties of completeness, consistency, consistence and continuity [64], [70], [73], [74].

- i. Completeness: The FLC rules base is complete if at any point in the input space there is at least one an active rule.
- ii. Consistency: The FLC rule-base is consistent if there no rules with similar IF sets, but different THEN sets.
- iii. Continuity: The FLC rule-base is continuous if there are no neighboring rules that have THEN sets with an empty intersection.

There are many different techniques for constructing a fuzzy rule-base with the Heuristic Method [75]–[77]. One of the common and widely used techniques is the Phase-Plane Trajectory method, introduced in [78]. With this method, the rules are justified based on a closed-loop trajectory in the phase plane. This method has been implemented in various fields in order to construct fuzzy rules for controlled systems [24], [79]–[81]. A detailed implementation of fuzzy rules design based on the Phase-Plane Trajectory method was carried out in [82]. In this study, a new procedure for designing a FLC was proposed based on the Phase-Plane Trajectory method. The phase plane was used to bridge the gap between the time-response and rule-base. Then the rule-base could be easily built using the general dynamics of the process. In addition, a practical guide to design FLC rules has been proposed in [83]. In this study, the rules table was categorized into different functions. The function of the rules in each set was determined by finding the dominant or important rules. Considering a 49 rule-base for IM drives, the zones and shifting routes of the rules table based on the Phase-Plane Trajectory method [83] is shown in Fig.3. There are five zones, where Zone 1 is responsible for system stability, Zones 2 and 4 are responsible for the responsiveness of the system, and Zones 3 and 5 are infrequently fired by the system [33].

Another approach to rule-base generation is the Deterministic Method. In this method, rules are constructed based on a fuzzy model of the process or self-learning fuzzy. Obtaining the fuzzy rules based on a self-tuning mechanism is called the Deterministic Method, since the controller itself finds the rules. This method has been implemented in different

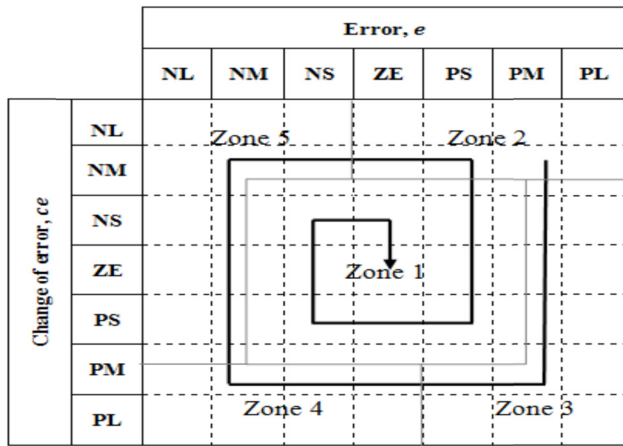

FIGURE 3. Zones and shifting route of rule base in a rule table.

applications such as [84]–[88]. Fuzzy identification proposed by Takagi and Sugeno [41] presented a deterministic fuzzy rules method where THEN is a polynomial of the input variable. In addition, [87] proposed a systematic design that self-generates fuzzy rules and a fuzzy rules table. The main issue with the deterministic rule-base method is that, the THEN part of fuzzy rule is a mathematical formula which may not provide a natural framework for representing human knowledge [64]. In addition, the complexity of the self-generating rules table may increase the computation requirements of the system [26], [27], [89].

Other essential elements of FLC are Membership Functions (MFs) and Scaling Factors (SFs). Two input MFs and one output MFs are used in FLC. Different shape and size MFs can be used in FLC, however; this paper utilized triangular MFs with three different sizes ( $3 \times 3$ ,  $5 \times 5$  and  $7 \times 9$ ) MFs as shown in Fig. 4. In addition, scaling factors are one of the most essential parameters of the FLC due to their critical impacts in the overall system performance. Two input SFs for error and change of error ( $G_e$ ,  $G_{ce}$ ), and one output SF of fuzzy output ( $G_{cu}$ ) are used in the FLC. The values of SFs chosen effectively to achieve good performance of IM drive based FLC speed controller.

In summary, different approaches can be applied to construct fuzzy rule-base tables. However, heuristic methods based on the Mamdani FLC type (particularly phase plane trajectory) is the most commonly used method and best-suited for hardware implementation. This is because, it provides a natural framework for representing human knowledge and demonstrates the versatility of the fuzzy system [90].

**B. FLC SIMPLIFICATION**

FLC model MFs, or rules, can be simplified in order to reduce system complexity and computational burden as well as enhance system performance. In this study, FLC rules simplification is considered, while MFs are assumed to be based on a designer’s choice, and the interface engine is based on the Mamdani FLC type. Rules simplification implies the

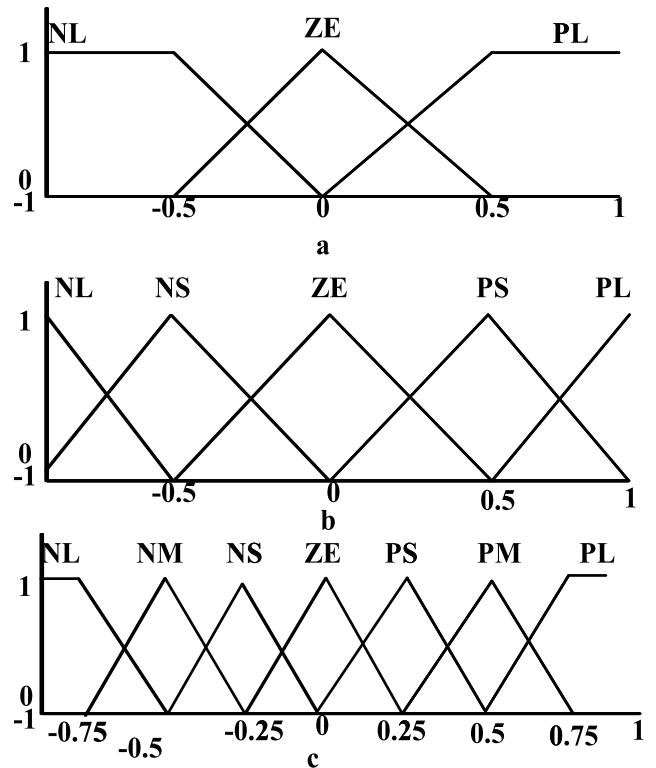

FIGURE 4. Different triangular MFs, (a)  $3 \times 3$ , (b)  $5 \times 5$ , and (c)  $7 \times 7$ .

process of reducing the number of fuzzy rules for a given system while maintaining or improving performance. Various researchers have proposed fuzzy rules reduction for different applications [91], [97].

In motor drives such as IM drives, Permanent Magnet Synchronous Motor (PMSM) drives, and DC motor drives, FLC is usually employed as the speed controller with two input variables and one output variable [98], [107]. The number of rules depends on the number of MFs used, where 49 rules are used for  $7 \times 7$  MFs, 25-rules are used for  $5 \times 5$  MFs, and 9 rules are used for  $3 \times 3$  MFs [24], [26]. A high number of fuzzy rules may enhance the performance of drive systems. However, this results in a large computational burden to the system [26], [27]. Large computational requirements increase the complexity and cost of hardware implementation. To overcome these issues, different approaches are proposed which reduce or simplify fuzzy rules, while maintaining performance of the drive system.

Rules simplification by reducing the number of MFs is one of the approaches used to reduce fuzzy rules. As proposed in [32], [33],  $7 \times 7$  MFs have been reduced to  $3 \times 3$  MFs, hence the number of fuzzy rules has been reduced from 49 to 9, which is the minimum number of rules possible. The drawback of this method is that, the output accuracy of the control is reduced due to the smaller number of MFs [20], [108], [109]. Another approach is to select the dominant rules and eliminate the weak ones. This method, initially proposed by Zheng in 1992, [83] uses a 49 rules-base categorized into five zones with specific functions for each

zone's rules. It was concluded that, rules in Zones 1, 2 and 4 are significant to the system, while rules in Zones 3 and 5 are infrequently fired by the system. Finally, 7 out of 49 rules were selected as the dominant rules, while the other rules were eliminated since they are inactive or infrequently fired by the system. The MFs with a  $7 \times 7$  matrix were the same as with a 49 rules-base. This method has been verified by other researchers for PMSM drives [33] and IM drives with  $5 \times 5$  MFs [34], [36]. The main issue with this rules simplification method is that the performance of the system is degraded at lower and reverse operating speeds.

Other fuzzy simplified rules methods have been proposed for motor drives. Authors in [110] proposed a simplified fuzzy rules for IM drives using different MFs values and importance for inputs, speed error and change-of-speed error. Using  $5 \times 3$  MFs with  $UoD \pm 1$  for input speed error,  $UoD \pm 8000$  used for input change-of-speed error, and  $UoD \pm 10$  for output fuzzy, results in a total of 15 fuzzy rules. The drawbacks of this method are that the rule-base selection is determined through trial and error which is time consuming and may lead to the selection of inappropriate or incomplete rules. Moreover, a very slow transient response is experienced in the system. In a similar way, the authors in [37] proposed  $5 \times 3$  asymmetrical trapezoidal and triangular MFs for inputs, speed error, and change-of-speed error. In order to reduce the computational load of real-time implementation, only 7 rules out of 15 are used, which have been determined based on trial and error. Other fuzzy rules simplification method is proposed in [111], in which simplified 4 rules are used to control the speed of IPMSM drive. Trapezoidal and triangular MFs are used for input and output variables in order to reduce computational loads for online implementation. Only speed error was considered as fuzzy input, while the change-of-speed error was neglected, since it does not have major effects on drive performance compared to the necessary increment of the computational burden when it is used. This method significantly simplifies the number of rules used by FLC, which can reduce the computational burden for online implementation. However, no systemic technique was proposed which can be followed for other applications. Furthermore, the speed performance of the drive was investigated only at forward operation and does not consider reverse operation. Authors in [15] proposed  $3 \times 3$  triangular MFs to control the speed of IM drives. Only 6 out of 9 fuzzy rules were selected for the rule-base, but a detailed explanation of the simplification method used was not included in the study. Further rules reduction approach has been proposed in [11], where  $7 \times 7$  MFs with 49 fuzzy rules were used to control the speed of IM drives. However, the proposed method required both long processing times and large computational times. In order to reduce processing time and meet the required sampling frequency, the rule-base had to be reduced to 20 rules. The rules reduction was achieved by eliminating the rules associated with medium positive, medium negative, and large negative speed errors. The elimination of these rules had minor impacts on the overall transient response

of the drive system. This proposed rule-reduction method realizes real-time implementation of the drive system. However, no methodological procedure was followed which can be incorporated into other drive applications.

In summary, it can be concluded that increasing the number of fuzzy rules directly increases the computational time of online implementation of the system. Fuzzy rules reduction methods have been proposed as an alternative approach which can utilize the features of fuzzy logic, while reducing the computational burden produced by a large rule-base. Fuzzy logic is an attractive control method for various applications, because it resembles human reasoning, and is able to handle non-linearity and parameters variation in the system. However, a large rule-base can increase the computational requirement for real-time implementation. Thus, simplified fuzzy rules methods may be used to reduce the fuzzy rules number, so that computational requirements are reduced, while maintaining system performance. Different rules reduction approaches have been investigated in the literature which strive to achieve the same goals of reducing system complexity and realizing real-time implementation of the system. Reducing the number of MFs, selection of the most dominant rules, using asymmetrical MFs with different values and importance for inputs, elimination of input variables, and rules selection based on trial and error, are among the commonly used fuzzy rule-reduction methods. For most of these methods, rule-base is determined empirically or based on intensive tunings which make them suitable only for a specific application. There is no study that has proposed a systematic procedure to design and simplify fuzzy rule-base which can be implemented in various applications. Most of the previous studies have focused on reducing the number of fuzzy rules for specific application based on empirical procedures in order to realize real-time implementation of that application. However, no systemic approach has been proposed which can be used to design and potentially simplify the fuzzy rule-base for different rules-sizes and different applications. In this paper, a new systematic method to design and simplify fuzzy rule-base is proposed. With the help of the Phase-Plane Trajectory method, fuzzy rule-base can be built and simplified based the general time response of the process or system. The following section will discuss in detail a fuzzy rule-base design and simplification process considering different rules-sizes and applications.

## V. PROPOSED FLC DESIGN AND SIMPLIFICATION

Fuzzy Logic Controller (FLC) architecture involves fuzzification, rule-base, interface engine, and defuzzification processes as shown in Fig.5.

In order to illustrate the processes of FLC system, FLC was assumed to be the feedback speed controller. Most feedback control systems deal with error  $E$  produced by the comparison between the actual system output and a desired reference output. The input variables for most FLCs-systems are error  $E$  and change-of-speed error  $\Delta E$  [20], [68]. The output variable for FLC is fuzzy increment  $U$ . Each fuzzy variable must be

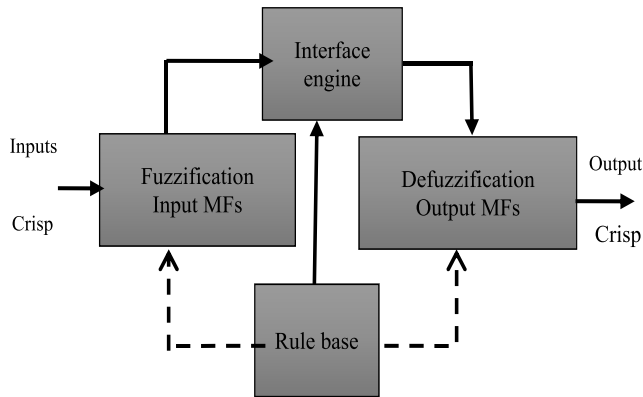

FIGURE 5. FLC architecture.

decoupled into a set of fuzzy regions. These sets are described with qualitative values called labels. The most widely used labels are: Positive Big (PB), Positive Medium (PM), Positive Small (PS), Zero (ZE), Negative Small (NS), Negative Medium (NM), and Negative Big (NB). The degree of each label is described by a fuzzy set. The function which relates the degree and the variable is referred to as Membership Function (MF). The grade of fuzziness of a linguistic variable essentially relies on the fuzziness of MFs label for that variable. Input variable error ( $E$ ) has the following label set:

$$L(E) = (NB, NS, ZE, PS, PB)$$

Each of these labels is confined in the universe discourse

$$U_E = [-2A, 2A]$$

The degree of each label is represented by a fuzzy set in the universe of discourse  $UoD$ :

$$F_i(E) = \int \mu_i(E)/E (i = NB, NS, ZE, PS, PB) \quad (14)$$

Hence, the MFs can be defined as follow:

$$F_i(E) = F_i^l(E) + F_i^r(E)$$

$$i = NS, ZE, PS$$

$$F_i(E) = F_i^l(E), i = NB$$

$$F_i(E) = F_i^r(E), i = PB$$

$F_i^l(E)$  and  $F_i^r(E)$  represent the left and right side of MF for each label respectively. The process of representing linguistic variables with MFs label is referred to as fuzzification process. This is the first process of FLC which involves fuzzifying linguistic inputs into fuzzy variables defined by MFs label in the UoD.

The second process of FLC is the rule-base, which includes forming rules to describe the relationship between the fuzzy input and output variables. Fuzzy rules can be expressed in the popular form of (IF-THEN). By considering generic closed-loop systems equipped with FLC, the fuzzy rules of two inputs ( $E, \Delta E$ ) and one output ( $\Delta U$ ), can be expressed as:

IF { $E$  is Big AND  $\Delta E$  is Small } THEN  $\Delta U$  is Medium

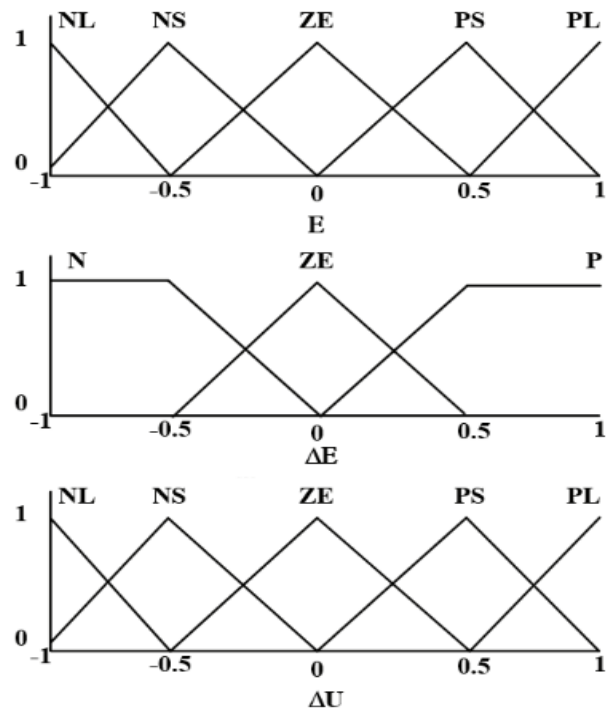

FIGURE 6. Inputs and outputs MFs, Error ( $E$ ), change of error ( $\Delta E$ ) and output control ( $\Delta U$ ).

where ( $E$ ) is error, ( $\Delta E$ ) is change of error, and ( $\Delta U$ ) is output fuzzy. Big, Small, and Medium are inputs- and output fuzzy sets with their corresponding linguistic values defined in the UoD. The possible number of fuzzy rules in two input and one output FLC depend on the number of fuzzy sets (MFs) defined in the UoD for each input variable. A FLC input variables with ( $A$ ) and ( $B$ ) MFs can produce possible ( $N$ ) fuzzy rules as expressed in the equation:

$$\text{Number of rules } (N) = E \text{ MFs } (A) \times \Delta E \text{ MFs } (B)$$

Additionally, MFs FLC output variables must equal to the highest MFs of any of the inputs- variables [26], [20], [112]. For instance, FLC with input error ( $E$ ) having 5 fuzzy sets defined in the UoD $\pm 1$  and input change of error ( $\Delta E$ ) having 3 fuzzy sets (MFs) defined in the UoD $\pm 1$  results in 15 fuzzy rules ( $5 \times 3$ ) with output ( $\Delta U$ ) having 5 fuzzy sets (MFs) defined in the UoD $\pm 1$ . Fig.6 shows the input and output MFs defined in the UoD $\pm 1$ , where a possible 15 fuzzy rules can be generated [110]. The generation of fuzzy rules based on this technique is considered standard FLC design. However, different FLC design techniques have been introduced and the resultant fuzzy rules number does not agree with these results [113]. An input variable MFs of ( $3 \times 5$ ) results in only 9 rules out of 15 total rules [114] and ( $5 \times 5$ ) input MFs result in 11 rules out 25 total rules [115].

FLC rules can be constructed using different approaches such as the Heuristic and Deterministic Methods which have been proposed by Ebrahim [116] and Takagi and Sugeno [117], respectively. With the Heuristic Method fuzzy



TABLE 1. Response area mapping.

Condition	Area
$E > 0$ and $\Delta E < 0$	A1
$E < 0$ and $\Delta E < 0$	A2
$E < 0$ and $\Delta E > 0$	A3
$E > 0$ and $\Delta E > 0$	A4
$E > 0 \rightarrow E < 0$ and $\Delta E < 0$	b1
$E < 0 \rightarrow E > 0$ and $\Delta E > 0$	b2
$E < 0$ and $\Delta E = 0$	C1
$E > 0$ and $\Delta E = 0$	C2

rules are formed based on engineering knowledge and behavioral modeling. With the Deterministic Method the rules are formed based on a fuzzy model of the process or based on self-learning fuzzy [70]. In this section, only the Heuristic Method based on Mamdani FLC will be considered. In general, FLC does not depend on the dynamic model of the system. However, FLC rule-base design essentially depends on engineering knowledge and experienced operation of the controlled system [113]. Different studies have utilized this method to form a rule-base for applications such as IM drive systems. But no detailed study has proposed a methodological approach to designing FLC rule base. This paper proposes a systemic method to design FLC rule-base based on the general step response of the controlled system.

The proposed method is primarily applicable to IM drives, where the rule-base of FLC speed controller can be built using the general step response of the IM drive. The IM drive system can be represented by a second order transfer function based on assumed characteristics of IM step response [27], [118], [119]. Hence, the step response of this second order transfer function can be used to design the rule-base of FLC speed control. This method can be applied to IM drive systems as well as any system or process that can be represented with a second order transfer function. Generally, the standard equation for second order transfer function can be expressed in the form:

$$G(s) = \frac{\omega_n^2}{s^2 + 2\varepsilon\omega_n s + \omega_n^2} \quad (15)$$

where  $\omega_n$  is the natural frequency and  $\varepsilon$  is the damping ratio. The general step response of a second order transfer function is shown in Fig.7 (a). The response can be divided into four areas (A1-A4), two crossover points (b1, b2) and two peak-valley points (c1, c2). Mapping the response with respect to error (E) and change of error ( $\Delta E$ ) creates the phase plane trajectory shown in Fig.7 (b). The response area was mapped based on Table1.

As can be seen from the phase plane trajectory mapping in Fig.7 (b), the system response moves toward the origin of the phase plane which is the equilibrium point of the system. At this point the system is stable and the error (E) and change of error ( $\Delta E$ ) are zero. The rule-base table can be formed from the area and points of the phase plane which includes all possible step responses as presented in Table2.

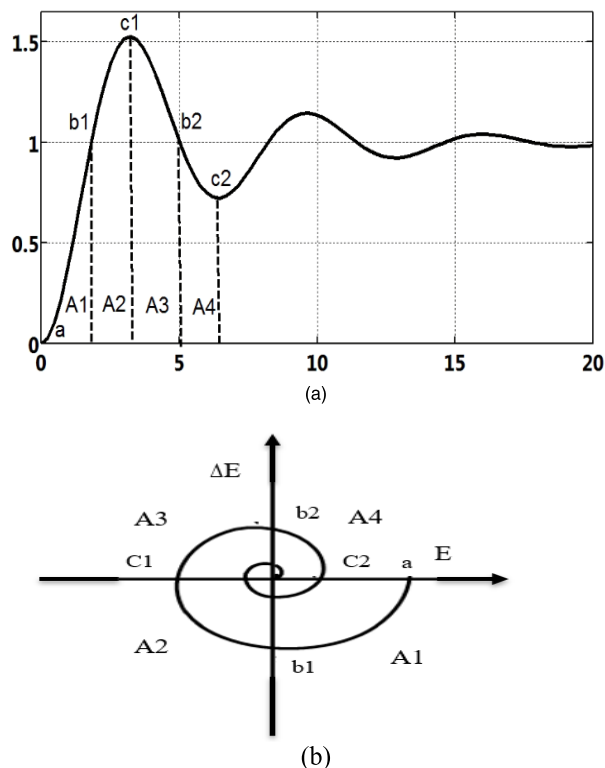

FIGURE 7. (a) Step response of second order system, (b) Phase-plane trajectory mapping.

The rule-base can be determined based on the following criteria [82], [120], [121]:

- i. Control rules at equilibrium point must keep the current output unchanged. E and  $\Delta E$  are zero, hence  $\Delta U$  is zero. This is can be expressed in (IF-THEN) form as:
  - Rule<sub>1</sub> IF {E is ZE AND  $\Delta E$  is ZE} THEN  $\Delta U$  is ZE*
- ii. Control rules when the error E is going to be zero, where E is the exact opposite of  $\Delta E$ , hence the  $\Delta U$  is zero, such condition is satisfied at following rules:
  1. For (3 × 3), (5 × 5) and (7 × 7) MFs:
    - Rule<sub>2</sub> IF {E is NL AND  $\Delta E$  is PL} THEN  $\Delta U$  is ZE*
    - Rule<sub>3</sub> IF {E is PL AND  $\Delta E$  is NL} THEN  $\Delta U$  is ZE*
  2. For (5 × 5) and (7 × 7) MFs only:
    - Rule<sub>4</sub> IF {E is NS AND  $\Delta E$  is PS} THEN  $\Delta U$  is ZE*
    - Rule<sub>5</sub> IF {E is PS AND  $\Delta E$  is NS } THEN  $\Delta U$  is ZE*
  3. For (7 × 7) MFs only:
    - Rule<sub>6</sub> IF {E is NM AND  $\Delta E$  is PM} THEN  $\Delta U$  is ZE*
    - Rule<sub>7</sub> IF {E is PM AND  $\Delta E$  is NM} THEN  $\Delta U$  is ZE*
- iii. Control rules in the area of cross-over points (b1, b2). These rules should be selected so that, the overshoot in area A2 and A4 is reduced. Since the error E is zero in

TABLE 2. Rule-base generation framework.

E ΔE	NL	NM	NS	ZE	PS	PM	PL
PL	A3			b2	A4		
PM							
PS	C1			ZE	C2		
ZE							
NS	A2			b1	A1		
NM							
NL							

this area, thus the output control ΔU follows the change of error ΔE:

1. For (3 × 3), (5 × 5) and (7 × 7) MFs:
  - Rule<sub>8</sub> IF{E is ZE AND ΔE is PL} THEN ΔU is PL
  - Rule<sub>9</sub> IF{E is ZE AND ΔE is NL} THEN ΔU is NL
2. For (5 × 5) and (7 × 7) MFs only:
  - Rule<sub>10</sub> IF{E is ZE AND ΔE is PS} THEN ΔU is PS
  - Rule<sub>11</sub> IF{E is ZE AND ΔE is NS} THEN ΔU is NS
3. For (7 × 7) MFs only:
  - Rule<sub>12</sub> IF{E is ZE AND ΔE is PM} THEN ΔU is PM
  - Rule<sub>13</sub> IF{E is ZE AND ΔE is NM} THEN ΔU is NM
- iv. Control rules for area of peak-valley points (C1, C2) should be selected so that, they speed up the response. Since, ΔE is zero in this area the output control ΔU will follow E:
  1. For (3 × 3), (5 × 5) and (7 × 7) MFs:
    - Rule<sub>14</sub> IF{E is PL AND ΔE is ZE} THEN ΔU is PL
    - Rule<sub>15</sub> IF{E is NL AND ΔE is ZE} THEN ΔU is NL
  2. For (5 × 5) and (7 × 7) MFs only:
    - Rule<sub>16</sub> IF{E is PS AND ΔE is ZE} THEN ΔU is PS
    - Rule<sub>17</sub> IF{E is NS AND ΔE is ZE} THEN ΔU is NS
  3. For (7 × 7) MFs only:
    - Rule<sub>18</sub> IF{E is PM AND ΔE is ZE} THEN ΔU is PM
    - Rule<sub>19</sub> IF{E is NM AND ΔE is ZE} THEN ΔU is NM
- v. Control rules for Area A1, in this area the E is positive, while ΔE is negative. Depending on the value of E, these rules are selected in order to produce faster rise time and prevent higher overshoot in the neighboring area. Thus:
  1. For (5 × 5) and (7 × 7) MFs only:

Rule<sub>20</sub> IF{E is PL AND ΔE is NS} THEN ΔU is PS

Rule<sub>21</sub> IF{E is PS AND ΔE is NL} THEN ΔU is NS

2. For (7 × 7) MFs only:

Rule<sub>22</sub> IF{E is PL AND ΔE is NM} THEN ΔU is PS

Rule<sub>23</sub> IF{E is PM AND ΔE is NL} THEN ΔU is NS

Rule<sub>24</sub> IF{E is PM AND ΔE is NS} THEN ΔU is PS

Rule<sub>25</sub> IF{E is PS AND ΔE is NM} THEN ΔU is NS

vi. Control rules for Area A2, E and ΔE in this area both negative, hence the rules must be selected to prevent and reduce high overshoot in A2. The rules are as follow:

1. For (3 × 3), (5 × 5) and (7 × 7) MFs:

Rule<sub>26</sub> IF {E is NL AND ΔE is NL} THEN ΔU is NL

2. For (5 × 5) and (7 × 7) MFs only:

Rule<sub>27</sub> IF{E is NL AND ΔE is NS} THEN ΔU is NL

Rule<sub>28</sub> IF{E is NS AND ΔE is NL} THEN ΔU is NL

Rule<sub>29</sub> IF{E is NS AND ΔE is NS} THEN ΔU is NS

3. For (7 × 7) MFs only:

Rule<sub>30</sub> IF{E is NL AND ΔE is NM} THEN ΔU is NL

Rule<sub>31</sub> IF{E is NM AND ΔE is NL} THEN ΔU is NL

Rule<sub>32</sub> IF{E is NM AND ΔE is NM} THEN ΔU is NL

Rule<sub>33</sub> IF{E is NM AND ΔE is NS} THEN ΔU is NL

Rule<sub>34</sub> IF{E is NS AND ΔE is NM} THEN ΔU is NL

vii. Control rules for Area A3, in this area, E is negative, while, ΔE is positive, hence the rules for this area must speed up the response and prevent high overshoot in the neighboring area:

1. For (5 × 5) and (7 × 7) MFs only:

Rule<sub>35</sub> IF{E is NL AND ΔE is PS} THEN ΔU is NS

Rule<sub>36</sub> IF{E is NS AND ΔE is PL} THEN ΔU is PS

2. For (7 × 7) MFs only:

Rule<sub>37</sub> IF{E is NL AND ΔE is PM} THEN ΔU is NS

Rule<sub>38</sub> IF{E is NM AND ΔE is PL} THEN ΔU is PS

Rule<sub>39</sub> IF{E is NM AND ΔE is PS} THEN ΔU is NS

TABLE 3. Rule-base for (3 × 3), (5 × 5) or (7 × 7) MFs.

E ΔE	NL	NM	NS	ZE	PS	PM	PL
<b>PL</b>	<b>ZE</b>	PS	<b>PS</b>	<b>PL</b>	<b>PL</b>	PL	<b>PL</b>
PM	NS	ZE	<b>PS</b>	<b>PM</b>	<b>PL</b>	PL	<b>PL</b>
<b>PS</b>	<b>NS</b>	NS	<b>ZE</b>	<b>PS</b>	<b>PS</b>	PL	<b>PL</b>
<b>ZE</b>	<b>NL</b>	NM	<b>NS</b>	<b>ZE</b>	<b>PS</b>	PM	<b>PL</b>
NS	NL	NL	NS	NS	ZE	PS	<b>PS</b>
NM	NL	NL	NL	NM	NS	ZE	<b>PS</b>
<b>NL</b>	<b>NL</b>	NL	NL	<b>NL</b>	NS	NS	<b>ZE</b>

Rule<sub>40</sub> IF{E is NS AND ΔE is PM} THEN ΔU is PS

viii. Control rules for Area A4, in this area both E and ΔE are positive; hence the rules must be selected to prevent high undershoot around the valley:

- For (3 × 3), (5 × 5) and (7 × 7) MFs:

Rule<sub>41</sub> IF{E is PL AND ΔE is PL} THEN ΔU is PL

- For (5 × 5) and (7 × 7) MFs only:

Rule<sub>42</sub> IF{E is PL AND ΔE is PS} THEN ΔU is PL

Rule<sub>43</sub> IF{E is PS AND ΔE is PL} THEN ΔU is PL

Rule<sub>44</sub> IF{E is PS AND ΔE is PS} THEN ΔU is PS

- For (7 × 7) MFs only:

Rule<sub>45</sub> IF{E is PL AND ΔE is PM} THEN ΔU is PL

Rule<sub>46</sub> IF{E is PM AND ΔE is PL} THEN ΔU is PL

Rule<sub>47</sub> IF{E is PM AND ΔE is PM} THEN ΔU is PL

Rule<sub>49</sub> IF{E is PM AND ΔE is PS} THEN ΔU is PL

Rule<sub>49</sub> IF{E is NS AND ΔE is PM} THEN ΔU is PL

By following these procedures, a total of 9, 25, or 49 rules can be generated from (3 × 3), (5 × 5), or (7 × 7) MFs respectively. The rule-base table for of (3 × 3), (5 × 5), or (7 × 7) MFs are presented in Table3, where (3 × 3) MFs are marked in red (NL, ZE, PL), and (5 × 5) MFs are bolded (NL, NS, ZE, PS, PL). The table as a whole represents (7 × 7) MFs (NL, NM, NS, ZE, PS, PM, PL).

To summarize, the fuzzy control rules of IM drives or any similar second order system can be determined from the general dynamic step response of the system. From the system step response, the system behavior aspects can be anticipated, and the phase plane trajectory can be mapped. Then the rule-base can be determined by following the above methodological procedures. Thus, a complete, consistent and continuous rule-base is generated for IM drive systems. In trajectory mapping of the step response of the system (Fig.7 (b)), the rules route starts from the outer area of the phase plane and continuously moves toward the equilibrium point, where

TABLE 4. Simplified 5-rules of (3 × 3) MFs.

E ΔE	NL	ZE	PL	* Simplified rules:
PL	ZE	PL	PL	1. IF{E is NL and ΔE is ZE} THEN ΔU is NL
ZE	NL	ZE	PL	2. IF{E is ZE and ΔE is PL} THEN ΔU is PL
NL	NL	NL	ZE	3. IF{E is ZE and ΔE is ZE} THEN ΔU is ZE
				4. IF{E is ZE and ΔE is NL} THEN ΔU is NL
				5. IF{E is PL and ΔE is NL} THEN ΔU is NL

TABLE 5. Simplified 7-rules of (5 × 5) MFs.

E ΔE	NL	NS	ZE	PS	PL	* Simplified rules :
PL	ZE	PS	PL	PL	PL	1. IF{E is NL and ΔE is ZE} THEN ΔU is NL
PS	NS	ZE	PS	PL	PL	2. IF{E is NS and ΔE is ZE} THEN ΔU is NS
ZE	NL	NS	ZE	PL	PL	3. IF{E is ZE and ΔE is PS} THEN ΔU is PS
NS	NL	NS	NS	PS	PS	4. IF{E is ZE and ΔE is ZE} THEN ΔU is ZE
NL	NL	NL	NL	ZE	ZE	5. IF{E is ZE and ΔE is NS} THEN ΔU is NS
						6. IF{E is PS and ΔE is ZE} THEN ΔU is PL
						7. IF{E is PL and ΔE is ZE} THEN ΔU is PL

error (E) and change of error (ΔE) are zero. The rules route usually passes through all step response areas (A1-A4), two cross-over points (b1, b2), and two peak-valley points (c1, c2), which creates a longer rules route. However, as the rules takes a shorter route to the equilibrium point, system stability increases. Shortening the rules route reduces the number of rules required. With phase plane mapping, the rules take a longer route by passing through outer areas of the step response. However, these areas can be ignored, and the rule can shorten its route to reach the equilibrium point, where the system becomes stable with zero error (E) and change of error (ΔE). The rules of (3 × 3) MFs can take a shorter route to reach the stable point at the origin of the phase plane. Thus, rules located far away from the equilibrium point can be ignored and only the rules which create a shorter route to the stable point are considered. Therefore, 5 rules are considered for (3 × 3) MFs, while 4 rules are ignored, thus reducing the online computation required by the fuzzy system (Table4).

Similarly, the rules route of (5 × 5) MFs can be shortened to quickly reach the stable point, as well as reduce the number of rules required. Shortening the rules route reduces the number of rules from 25 to 7 rules as shown in Table5, where the selected rules are highlighted, and other rules are ignored. This effectively reduce the computational requirement of the fuzzy system since the rules number has been reduced significantly.

The 49 rules of (7 × 7) MFs can be reduced by selecting only the rules that form the shortest route to the equilibrium point. Nine rules out of 49 create a short route to the equilibrium point, where the error (E) and change of error (ΔE) are zero. The simplified 9-rules are presented in Table6, where the selected rules are highlighted. The FLC of (7 × 7) MFs

TABLE 6. Simplified 9-rules of (7 × 7) MFS.

E ΔE	NL	NM	NS	ZE	PS	PM	PL
PL	ZE	PS	PS	PL	PL	PL	PL
PM	NS	ZE	PS	PM	PL	PL	PL
PS	NS	NS	ZE	PS	PS	PL	PL
ZE	NL	NM	NS	ZE	PS	PM	PL
NS	NL	NL	NS	NS	ZE	PS	PS
NM	NL	NL	NL	NM	NS	ZE	PS
NL	NL	NL	NL	NL	NS	NS	ZE

\* Simplified rules :

1. IF{E is NL and ΔE is ZE} THEN ΔU is NL
2. IF{E is NM and ΔE is ZE} THEN ΔU is NM
3. IF{E is NS and ΔE is ZE} THEN ΔU is NS
4. IF{E is ZE and ΔE is PS} THEN ΔU is PS
5. IF{E is ZE and ΔE is ZE} THEN ΔU is ZE
6. IF{E is ZE and ΔE is NS} THEN ΔU is NS
7. IF{E is PS and ΔE is ZE} THEN ΔU is PS
8. IF{E is PM and ΔE is ZE} THEN ΔU is PM
9. IF{E is PL and ΔE is ZE} THEN ΔU is PL

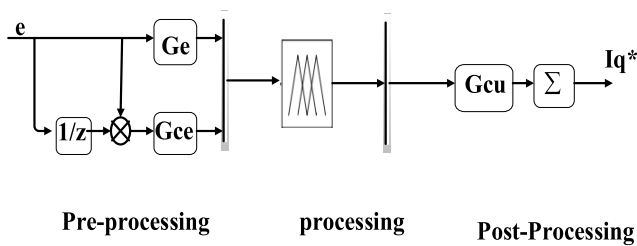

FIGURE 8. The standard model of FLC.

has a very high output accuracy, but it utilizes 49 rules that increase the online computation of the fuzzy system and/or the hardware cost. In this simplified rule method, only 9 rules considered, while the remaining 40 rules are deleted. This reduces the computation capabilities required by the fuzzy system. Thus, system hardware can be constructed with a high output accuracy of FLC and without requiring additional processing capabilities.

In this section, a systemic and sequential method for designing and simplifying FLC rule-base has been proposed. The method is based on the general dynamic step response of the IM drives system which has been divided into areas and points, then mapped onto a phase plane trajectory. Based on phase plane mapping, control rules were chosen to cover all potential areas of step response. In addition, the designed rule-base was simplified such that, only the rules which can create the shortest route to the equilibrium point were considered. This method was applied to the design rules of (3 × 3), (5 × 5), and (7 × 7) MFs and reduced the rules number from 9, 25 and 49 to 5, 7, and 9 respectively. This method follows more systemic procedures than has previously been documented and significantly reduced the rules number of all the MFs tested, thus allowing implementation of high output accuracy FLC without a significant increment in the computational burden and/or hardware costs. Simulation validation of the proposed FLC design and simplified rules discussed in the next section based on IM drive system.

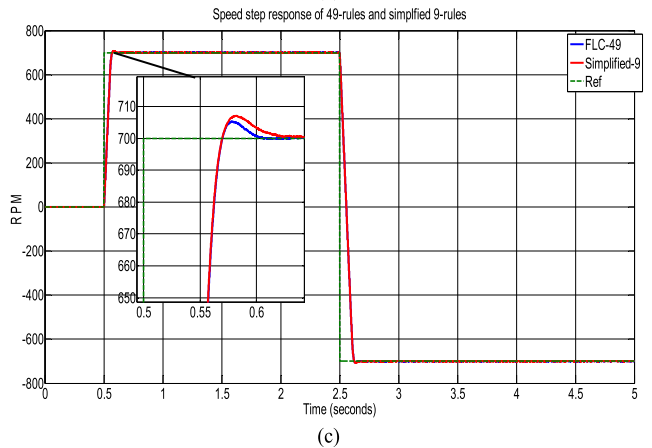
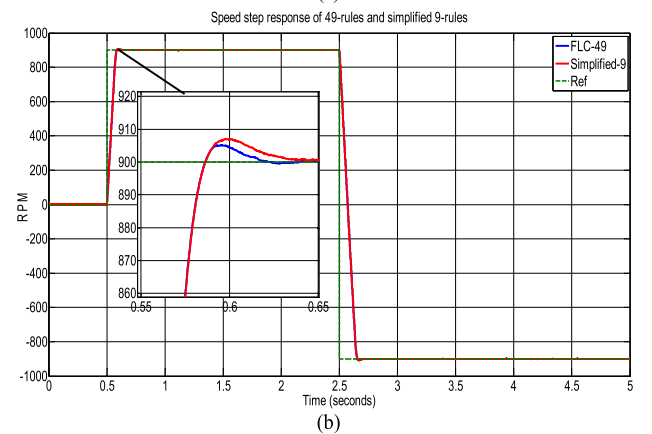
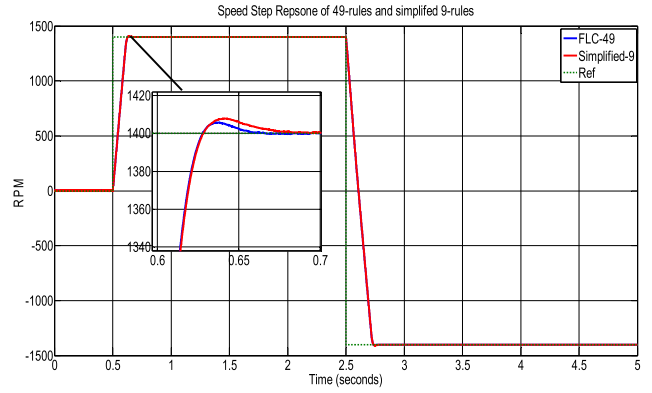
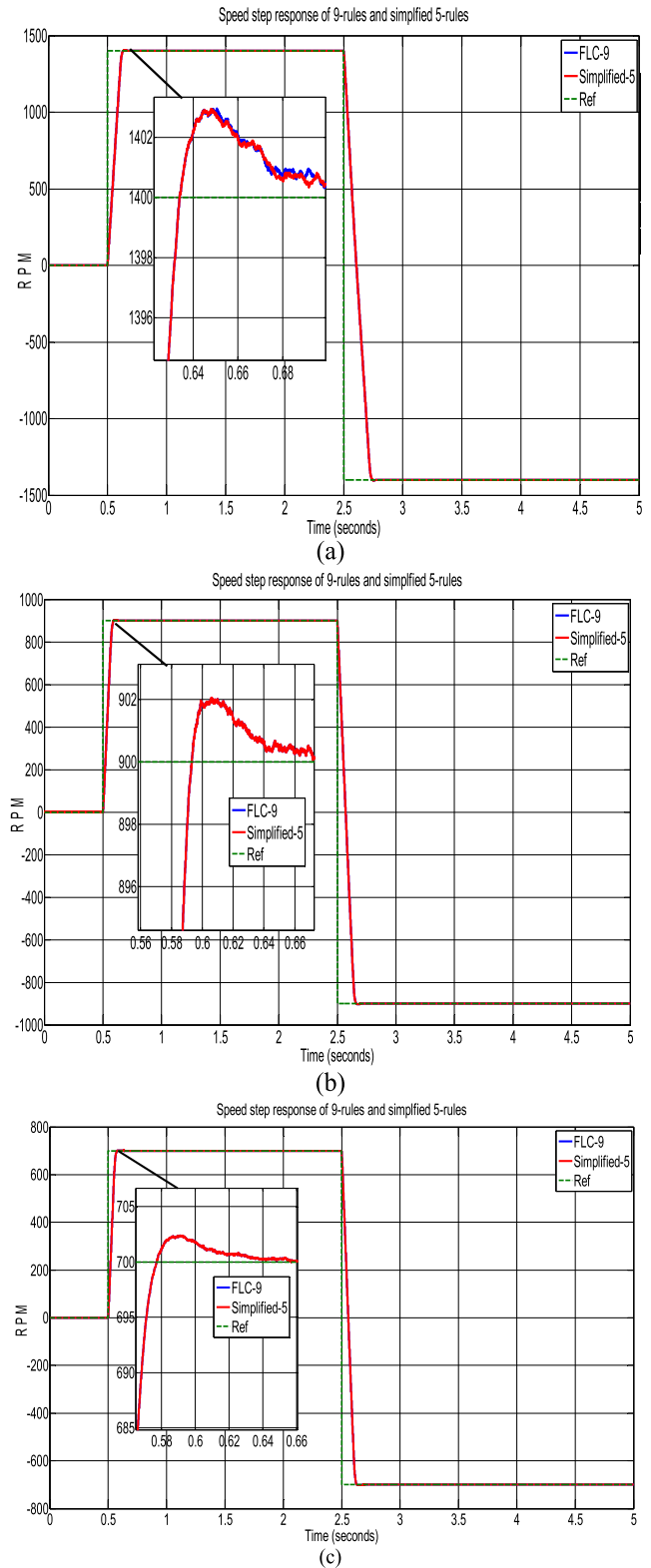
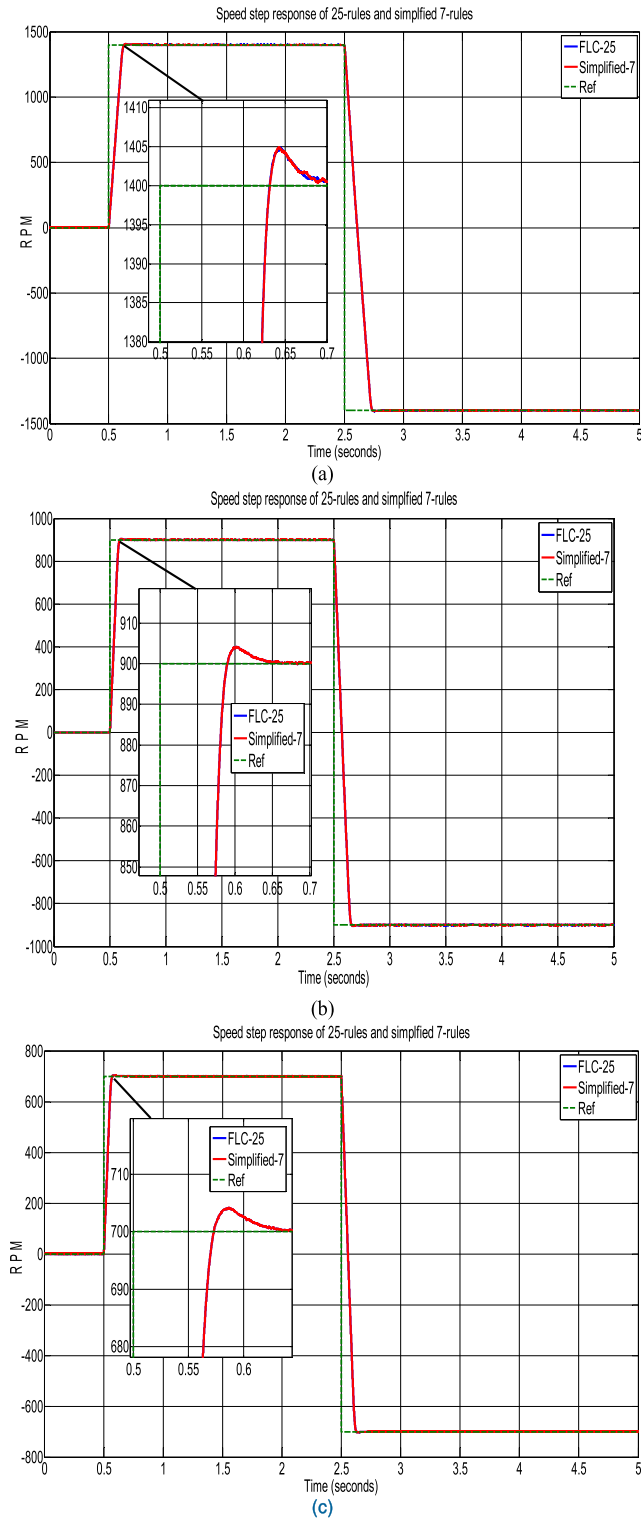

FIGURE 9. Speed step responses comparison of Standard 49-rules and simplified 9-rules at, (a) 1400 rpm, (b) 900 rpm and (c) 700rpm.

VI. SIMULATION TESTING

In order to verify the workability and effectiveness of the proposed FLC rules design and simplification, IM drive system based Indirect Field Oriented Control (IFOC) was considered. The designed and simplified rules were applied to control the speed of the IM drive, where 2hp IM was used with the parameters presented in Appendix 1. The step responses of various speed operations were measured with both standard designed FLC rules and simplified FLC rules. Only FLC rules are different in both standard and simplified rules FLC, while MFs and scaling factors were kept constant. Performance comparisons were done between standard designed FLC rules





**FIGURE 10.** Speed step responses comparison of Standard 25-rules and simplified 7-rules at, (a) 1400 rpm, (b) 900 rpm and (c) 700rpm.

**FIGURE 11.** Speed step responses comparison of Standard 9-rules and simplified 5-rules at, (a) 1400 rpm, (b) 900 rpm and (c) 700rpm.

and simplified FLC rules at various speeds of operation in order to observe the effects of reducing the rules number on drive performances. Fig.8 shows the model of the FLC system used, where two input variables, error ( $E$ ) and change of error ( $\Delta E$ ), and one output variable ( $\Delta U$ ) were used.

Step speed response comparisons of the standard designed 9, 25, and 49 rules and simplified 5, 7, and 9 rules were performed to show the effects of rules elimination on

**TABLE 7.** Time response characteristics.

Item \ MFs	7x7		5x5		3x3	
	49-rules	9-rules	25-rules	7-rules	9-rules	5-rules
OS (%)	0.43	0.57	0.35	0.36	0.21	0.21
Ts (s)	0.16	0.18	0.17	0.18	0.18	0.18
Tr(s)	0.094	0.094	0.095	0.096	0.093	0.093

speed performance. The speed performance comparison of the standard 49 rules and simplified 9 rules are presented in Fig.9 at 1400rpm, 900rpm and 700rpm. In addition, Fig.10 shows the speed performance comparison of the standard 25 rules and simplified 7 rules at 1400rpm, 900rpm and 700rpm. Finally, the speed performance of the standard 9 rules and the simplified 5 rules are shown in Fig.11 at 1400rpm, 900rpm and 700rpm. Simplified rules produced the same results or almost the same results as the standard rules, thus verifying the accuracy of the selected simplified rules, as well as the effectiveness of the proposed simplified rules method. In addition, numerical comparison of standard FLC rules and simplified FLC rules is conducted in terms of Overshoot (OS), Settling time (Ts) and Rise Time (Tr). The numerical analysis of standard FLC rules (49, 25, 9) and simplified rules (9, 7, 5) is presented in Table 7.

Based on the graphical and numerical analysis of the proposed simplified rules, the simplified FLC (9, 7, 5) rules achieve almost similar performance as the standard FLC (49, 25, 9) rules using the same MFs of ( $7 \times 7$ ,  $5 \times 5$ ,  $3 \times 3$ ). This verifies the effectiveness of the proposed rules simplification/reduction method. The obtained simplified rules can improve the performance of the IM drive, where less fuzzy rules reduces the computational requirements of system. Thus, the IM drive system can operate at higher sampling frequency increasing the overall drive performance.

## VII. CONCLUSION

This paper investigated the design, simplification, and operation of FLC for speed control of IM drives. Since the invention of FLC in the 1970s, its use has been growing rapidly covering a wide variety of applications, including high performance AC drives. The ability of FLC to imitate human reasoning has made it a preferred controller in non-linear applications whose mathematical models are very complicated and cannot be easily controlled with conventional non-fuzzy controller. In IM drives systems, FLC is primarily used as a speed controller, where the motor speed is compared with a reference speed and the resultant error is fed into FLC to produce the output control signal. Based on the literature, there are different types of FLC implications. However, a Mamdani FLC type with fuzzification, rule-base, interface engine, and defuzzification processes is the most commonly used FLC. Rule-base design has been critically reviewed in this paper. Different FLC rule-base design approaches have been investigated, including the Phase-Plane Trajectory method, which is an effective method for designing

**TABLE 8.** Motor parameters.

Parameter	Value
Rated power	2hp
Rated voltage	500Vdc
Rated frequency	50Hz
Rated Speed	1500 rpm
Number of poles	4
Stator resistance	3.4 $\Omega$
Stator inductance	320mH
Rotor resistance	3.6 $\Omega$
Rotor inductance	325mH
Inertia	0.01 $kgm^2$

FLC rule-base. In addition, FLC rules simplification has been discussed in detail, investigating different methods presented in the literature and evaluating their proposed simplification techniques in terms of systematic procedures and the possibility of using them in other applications.

Most of the proposed FLC simplified rules approaches lack systematic procedures that can be implemented in different applications. Therefore, this paper proposed FLC rule-base design methodology based on the dynamic step response of the controlled system. IM drive, represented by a second order transfer function, was considered for applying the proposed method in order to obtain the rule-base of FLC speed controller of IM drives. Three different rule-bases were generated from (9, 25, and 49) rules based on the step response of the second order IM drive system and phase plane trajectory mapping. Then, using the concept of selecting shorter rule route to reach the equilibrium point, the designed (9, 25, 49) rules have been simplified into (5, 7, 9) rules. Finally, simulation testing of the IM drives system based on IFOC has been performed with both standard (9,25,49) rules and simplified (5,7,9) rules. Step speed performance comparisons demonstrated that simplified rules maintained drive performance and had similar behavior as the standard rules.

The proposed FLC rule-base design and simplification presents a systematic approach which can be followed to design the rule-base of FLC speed controller of IM drive or any similar second order system. In addition, the effectiveness and accuracy of the simplified rules have been verified with simulation analysis. Therefore, FLC can be implemented based on the proposed method with less computational burden to the controlled system.

## APPENDIX

See Table 8.

## REFERENCES

- [1] L. Chen, X. Sun, H. Jiang, and X. Xu, "A high-performance control method of constant  $V/f$ -controlled induction motor drives for electric vehicles," *Math. Problems Eng.*, vol. 2014, pp. 1–10, Jan. 2014.
- [2] S. Vaez-Zadeh and E. Jalali, "Combined vector control and direct torque control method for high performance induction motor drives," *Energy Convers. Manage.*, vol. 48, no. 12, pp. 3095–3101, Dec. 2007.
- [3] C.-M. Liaw and J.-B. Wang, "Design and implementation of a fuzzy controller for a high performance induction motor drive," *IEEE Trans. Syst., Man, Cybern.*, vol. 21, no. 4, pp. 921–929, Jul./Aug. 1991.

- [4] K. Wang, Y. Li, Q. Ge, and L. Shi, "An improved indirect field-oriented control scheme for linear induction motor traction drives," *IEEE Trans. Ind. Electron.*, vol. 65, no. 12, pp. 9928–9937, Dec. 2018.
- [5] J. K. Pandit, M. V. Aware, R. V. Nemade, and E. Levi, "Direct torque control scheme for a six-phase induction motor with reduced torque ripple," *IEEE Trans. Power Electron.*, vol. 32, no. 9, pp. 7118–7129, Sep. 2017.
- [6] Y. Zhang and H. Yang, "Model predictive control of induction motor drives: Flux control versus torque control," in *Proc. 9th Int. Conf. Power Electron. ECCE Asia (ICPE-ECCE Asia)*, Jun. 2015, pp. 4050–4060.
- [7] Y. Zhang, H. Yang, and B. Xia, "Model-predictive control of induction motor drives: Torque control versus flux control," *IEEE Trans. Ind. Appl.*, vol. 52, no. 5, pp. 4050–4060, Sep./Oct. 2016.
- [8] R. Wang, F. Zhang, Z. Mei, X. Rodríguez, and J. Kennel, "Advanced control strategies of induction machine: Field oriented control, direct torque control and model predictive control," *Energies*, vol. 11, no. 1, p. 120, 2018.
- [9] B. L. G. Costa, C. L. Graciola, B. A. Angélico, A. Goedtel, and M. F. Castoldi, "Metaheuristics optimization applied to PI controllers tuning of a DTC-SVM drive for three-phase induction motors," *Appl. Soft Comput.*, vol. 62, pp. 776–788, Jan. 2018.
- [10] R. Errouissi, A. Al-Durra, and S. M. Mueyeen, "Experimental validation of a novel PI speed controller for AC motor drives with improved transient performances," *IEEE Trans. Control Syst. Technol.*, vol. 26, no. 4, pp. 1414–1421, Jul. 2018.
- [11] A. M. Khambadkone and J. Holtz, "Compensated synchronous PI current controller in overmodulation range and six-step operation of space-vector-modulation-based vector-controlled drives," *IEEE Trans. Ind. Electron.*, vol. 49, no. 3, pp. 574–580, Jun. 2002.
- [12] Z. Ibrahim and E. Levi, "A comparative analysis of fuzzy logic and PI speed control in high-performance AC drives using experimental approach," *IEEE Trans. Ind. Appl.*, vol. 38, no. 5, pp. 1210–1218, Sep. 2002.
- [13] D. Zhang, H. Li, and E. G. Collins, "Digital anti-windup PI controllers for variable-speed motor drives using FPGA and stochastic theory," *IEEE Trans. Power Electron.*, vol. 21, no. 5, pp. 1496–1501, Sep. 2006.
- [14] S. Gdaim, A. Mtibaa, and M. F. Mimouni, "Design and experimental implementation of DTC of an induction machine based on fuzzy logic control on FPGA," *IEEE Trans. Fuzzy Syst.*, vol. 23, no. 3, pp. 644–655, Jun. 2015.
- [15] S. Lekhchine, T. Bahi, and Y. Soufi, "Indirect rotor field oriented control based on fuzzy logic controlled double star induction machine," *Int. J. Electr. Power Energy Syst.*, vol. 57, pp. 206–211, May 2014.
- [16] Z. M. Elbarbary, H. A. Hamed, and E. E. El-Kholy, "Comments on 'A performance investigation of a four-switch three-phase inverter-fed IM drives at low speeds using fuzzy logic and PI controllers,'" *IEEE Trans. Power Electron.*, vol. 33, no. 9, pp. 8187–8188, Sep. 2018.
- [17] K. Zeb, Z. A. K. Saleem, and W. U. M. A. Javed, "Indirect field-oriented control of induction motor drive based on adaptive fuzzy logic controller," *Electr. Eng.*, vol. 99, pp. 803–815, Nov. 2017.
- [18] J. L. F. Daya, V. Subbiah, I. Atif, and P. Sanjeevikumar, "Novel wavelet-fuzzy based indirect field oriented control of induction motor drives," *J. Power Electron.*, vol. 13, no. 4, pp. 656–668, Jul. 2013.
- [19] B. Kumar, Y. K. Chauhan, and V. Shrivastava, "Efficacy of different rule based fuzzy logic controllers for induction motor drive," *Int. J. Mach. Learn. Comput.*, vol. 2, no. 2, pp. 131–137, 2012.
- [20] E. Abdelkarim, M. Ahmed, M. Orabi, and P. Mutschler, "Fuzzy logic speed controller of 3-Phase induction motors for efficiency improvement," *J. Power Electron.*, vol. 12, no. 2, pp. 305–316, Mar. 2012.
- [21] F. Betin, D. Pinchon, and G.-A. Capolino, "Fuzzy logic applied to speed control of a stepping motor drive," *IEEE Trans. Ind. Electron.*, vol. 47, no. 3, pp. 610–622, Jun. 2000.
- [22] B. Heber, L. Xu, and Y. Tang, "Fuzzy logic enhanced speed control of an indirect field-oriented induction machine drive," *IEEE Trans. Power Electron.*, vol. 12, no. 5, pp. 772–778, Sep. 1997.
- [23] B. N. Kar, K. B. Mohanty, and M. Singh, "Indirect vector control of induction motor using fuzzy logic controller," in *Proc. 10th Int. Conf. Environ. Electr. Eng.*, no. 4, May 2011, pp. 6–9.
- [24] I. Birou, V. Maier, S. Pavel, and C. Rusu, "Indirect vector control of an induction motor with fuzzy-logic based speed controller," *Adv. Electr. Comput. Eng.*, vol. 10, no. 1, pp. 116–120, 2010, 2015.
- [25] M. H. N. Talib, Z. Ibrahim, Z. Rasin, J. M. Lazi, and M. Azri, "Investigation of different rules size FLSC performance applied to induction motor drive," *J. Telecommun. Electron. Comput. Eng.*, vol. 9, no. 2, pp. 165–169.
- [26] Z. Kandoussi, Z. Boulghasoul, A. Elbacha, and A. Tajer, "Real time implementation of a new fuzzy-sliding-mode-observer for sensorless IM drive," *COMPEL-Int. J. Comput. Math. Electr. Electron. Eng.*, vol. 36, no. 4, pp. 938–958, Jul. 2017.
- [27] N. S. Y. Farah, M. H. N. Talib, Z. Ibrahim, Z. I. Rizman, and Z. Rasin, "Retracted: Experimental investigation of different rules size of fuzzy logic controller for vector control of induction motor drives," *J. Fundam. Appl. Sci.*, vol. 10, no. 6s, pp. 1696–1717, 2018.
- [28] M. Masiala, B. Vafakhah, J. Salmon, and A. M. Knight, "Fuzzy self-tuning speed control of an indirect field-oriented control induction motor drive," *IEEE Trans. Ind. Appl.*, vol. 44, no. 6, pp. 1732–1740, Nov. 2008.
- [29] M. N. Uddin, Z. R. Huang, and M. M. I. Chy, "A simplified self-tuned neuro-fuzzy controller based speed control of an induction motor drive," in *Proc. IEEE Power Eng. Soc. Gen. Meeting*, Jun. 2007, pp. 1–8.
- [30] H. Chaoui and P. Sicard, "Adaptive fuzzy logic control of permanent magnet synchronous machines with nonlinear friction," *IEEE Trans. Ind. Electron.*, vol. 59, no. 2, pp. 1123–1133, Feb. 2012.
- [31] M. Karmazin, "Simplified fuzzy logic controller based indirect vector control of an induction motor drive," M.S. thesis, Memorial Univ. Newfoundland, John's, NL, Canada, 2003.
- [32] S. N. Mat Isa, Z. Ibrahim, J. M. Lazi, M. H. N. Talib, N. M. Yaakop, and A. S. A. Hasim, "DSPACE DSP based implementation of simplified fuzzy logic speed controller for vector controlled PMSM drives," in *Proc. IEEE Int. Conf. Power Energy (PECon)*, Dec. 2012, pp. 2–5.
- [33] R. O. Z. Salleh, M. Sulaiman, and F. A. Patakor, "Rules reduction and optimization of fuzzy logic membership functions for induction motor speed controller," *J. Theor. Appl. Inf. Technol.*, vol. 95, no. 19, pp. 4922–4934, 2017.
- [34] Z. Ibrahim, S. Noormiza, M. Isa, J. M. Lazi, and H. N. Talib, "Simplified fuzzy logic speed controller for vector controlled permanent magnet synchronous motor drives," *Int. Rev. Electr. Eng.*, vol. 8, no. 1, pp. 104–113, 2013.
- [35] M. H. N. Talib, Z. Ibrahim, N. A. Rahim, A. S. A. Hasim, and H. Zainuddin, "Performance improvement of induction motor drive using simplified FLC method," in *Proc. 16th Int. Power Electron. Motion Control Conf. Exposit.*, Sep. 2014, pp. 707–712.
- [36] M. J. Hossain, M. A. Hoque, and K. K. Islam, "Simplified fuzzy control for flux-weakening speed control of IPMSM drive," *Adv. Fuzzy Syst.*, vol. 2011, pp. 1–9, Jul. 2011.
- [37] M. H. N. Talib, Z. Ibrahim, Z. Rasin, J. M. Lazi, M. Azri, and N. S. Y. Farah, "Experimental analysis of simplified rules fuzzy logic speed controller for wide speed range operations," *Int. J. Power Electron. Drive Syst.*, vol. 9, no. 3, pp. 1090–1097, 2018.
- [38] M. N. Uddin, T. S. Radwan, and M. A. Rahman, "Performances of fuzzy-logic-based indirect vector control for induction motor drive," *IEEE Trans. Ind. Appl.*, vol. 38, no. 5, pp. 1219–1225, Sep. 2002.
- [39] L. A. Zadeh, "Outline of a new approach to the analysis of complex systems and decision processes," *IEEE Trans. Syst., Man, Cybern.*, vol. SMC-3, no. 1, pp. 28–44, Jan. 1973.
- [40] L. A. Zadeh, "Fuzzy sets," *Inf. Control*, vol. 8, no. 3, pp. 338–353, 1965.
- [41] E. H. Mamdani and S. Assilian, "An experiment in linguistic synthesis with a fuzzy logic controller," *Int. J. Man. Mach. Stud.*, vol. 51, no. 2, pp. 135–147, 1999.
- [42] T. Takagi and M. Sugeno, "Fuzzy identification of systems and its applications to modeling and control," *IEEE Trans. Syst. Man Cybern.*, vol. SMC-15, no. 1, pp. 116–132, Jan./Feb. 1985.
- [43] M. Sugeno, *Industrial Applications of Fuzzy Control*. Tokyo, Japan: Elsevier, 1985.
- [44] N. Farah, M. H. N. Talib, Z. Ibrahim, J. M. Lazi, and M. Azri, "Self-tuning fuzzy logic controller based on takagi-sugeno applied to induction motor drives," *Int. J. Power Electron. Drive Syst.*, vol. 9, no. 4, pp. 1967–1975, 2018.
- [45] N. Sabri, S. A. Aljunid, M. S. Salim, R. B. Badlishah, R. Kamaruddin, and M. F. A. Malek, "Fuzzy inference system: Short review and design," *Int. Rev. Autom. Control*, vol. 6, no. 4, pp. 441–449, 2013.
- [46] A. G. Aissauoi and A. Tahour, "Application of fuzzy logic in control of electrical machines," in *Fuzzy Logic-Controls, Concepts, Theorie and Applications*, no. 2012. Rijeka, Croatia: InTech, 2012.

- [46] M. A. Hannan, Z. A. Ghani, M. M. Hoque, P. J. Ker, A. Hussain, and A. Mohamed, "Fuzzy logic inverter controller in photovoltaic applications: Issues and recommendations," *IEEE Access*, vol. 7, pp. 24934–24955, 2019.
- [47] A. Ghasemi, S. S. Mortazavi, and R. Kianinezhad, "Fuzzy logic controlled adaptive active power filter for harmonics minimization and reactive power compensation under fast load variation," *WSEAS Trans. Power Syst.*, vol. 3, no. 5, pp. 300–309, 2008.
- [48] C. Lee, S. Member, and M. Wang, "A fuzzy expert system for diabetes decision support application," *IEEE Trans. Syst., Man, Cybern. B, Cybern.*, vol. 41, no. 1, pp. 139–153, Feb. 2011.
- [49] H. Singh, M. M. Gupta, T. Meitzler, Z. Hou, K. K. Garg, A. M. G. Solo, and L. A. Zadeh, "Real-life applications of fuzzy logic," *Adv. Fuzzy Syst.*, vol. 2013, pp. 1–3, Jun. 2013.
- [50] A. T. Azar, "Overview of type-2 fuzzy logic systems," *Int. J. Fuzzy Syst. Appl.*, vol. 2, no. 4, pp. 1–28, 2014.
- [51] Q. Liang and J. M. Mendel, "Interval type-2 fuzzy logic systems: Theory and design," *IEEE Trans. Fuzzy Syst.*, vol. 8, no. 5, pp. 535–550, Oct. 2000.
- [52] L. A. Zadeh, "The concept of a linguistic variable and its application to approximate reasoning-I," *Inf. Sci.*, vol. 8, no. 3, pp. 199–249, 1975.
- [53] N. N. Karnik, J. M. Mendel, and Q. Liang, "Type-2 fuzzy logic systems," *IEEE Trans. Fuzzy Syst.*, vol. 7, no. 6, pp. 643–658, Dec. 1999.
- [54] T. Ramesh, A. K. Panda, and S. S. Kumar, "Type-2 fuzzy logic control based MRAS speed estimator for speed sensorless direct torque and flux control of an induction motor drive," *ISA Trans.*, vol. 57, pp. 262–275, Jul. 2015.
- [55] A. Khemis, I. Benlaloui, S. Drid, L. Chriif-Alaoui, D. Khamari, and A. Menacer, "High-efficiency induction motor drives using type-2 fuzzy logic," *Eur. Phys. J. Plus*, vol. 133, no. 3, pp. 1–12, Mar. 2018.
- [56] P. Taylor, N. V. Naik, and S. P. Singh, "Improved torque and flux performance of type-2 fuzzy-based direct torque control induction motor using space vector pulse-width modulation," *Electr. Power Compon. Syst.*, vol. 42, no. 6, pp. 37–41, 2014.
- [57] B. Leila, "Type-2 fuzzy logic controller of a doubly fed induction machine," *Adv. Fuzzy Syst.*, vol. 2016, no. 4, pp. 1–10, 2018.
- [58] E. Ontiveros-Robles, P. Melin, and O. Castillo, "New methodology to approximate type-reduction based on a continuous root-finding karnik mendel algorithm," *Algorithms*, vol. 10, no. 3, p. 77, 2017.
- [59] D. Wu, "Approaches for reducing the computational cost of interval type-2 fuzzy logic systems: Overview and comparisons," *IEEE Trans. Fuzzy Syst.*, vol. 21, no. 1, pp. 80–99, Feb. 2013.
- [60] M. Almarashi, R. John, A. Hoggood, and S. Ahmadi, "Learning of interval and general type-2 fuzzy logic systems using simulated annealing: Theory and practice," *Inf. Sci.*, vol. 360, pp. 21–42, Sep. 2016.
- [61] A. P. Mark, R. Vairamani, and G. C. R. Irudayaraj, "Mathematical modeling and analysis of different vector controlled CSI fed 3-Phase induction motor drive," *J. Appl. Math.*, vol. 2014, pp. 1–13, Jul. 2014.
- [62] M. Ahmad, "Modeling of Induction and Synchronous Machines," in *High Performance AC Drives (Power Systems)*, vol. 10, 1st ed. Berlin, Germany: Springer, 2010, pp. 13–45.
- [63] R. G. Lee, P. Pillay, and R. G. Harley, "D,Q reference frames for the simulation of induction motors," *Electr. Power Syst. Res.*, vol. 8, no. 1, pp. 15–26, 1984.
- [64] L.-X. Wang, *A Course in Fuzzy Systems and Control*, 2nd ed. Upper Saddle River, NJ, USA: Prentice-Hall, 1997.
- [65] M. Sugeno and G. T. Kang, "Structure identification of fuzzy model," *Fuzzy Sets Syst.*, vol. 28, no. 1, pp. 15–33, Oct. 1988.
- [66] F. S. Smith and Q. Shen, "Selecting inference and defuzzification techniques for fuzzy logic control," in *Proc. UKACC Int. Conf. Control*, vol. 1, Sep. 1998, pp. 49–54.
- [67] A. V. Patel and B. M. Mohan, "Analytical structures and analysis of the simplest fuzzy PI controllers," *Automatica*, vol. 38, no. 6, pp. 981–993, Jun. 2002.
- [68] K. M. Passino, M. Reinfrank, and S. Yurkovich, *Fuzzy Control*, 1st ed. Menlo Park, CA, USA: Addison-Wesley, 1988.
- [69] G. E. D'Errico, "Fuzzy control systems with application to machining processes," *J. Mater. Process. Technol.*, vol. 109, nos. 1–2, pp. 38–43, Feb. 2001.
- [70] C. C. Lee, "Fuzzy logic in control systems: Fuzzy logic controller," *IEEE Trans. Syst. Man, Cybern.*, vol. 20, no. 2, pp. 419–435, Mar. 1990.
- [71] P. J. J. Yan and M. Ryan, *Using Fuzzy Logic: Towards Intelligent Systems*, Hemel Hempstead, U.K.: Prentice-Hall, 1994.
- [72] Y. Torun, "Fuzzy logic control to be conventional method," *Energy Convers. Manage.*, vol. 47, no. 4, pp. 377–394, Mar. 2006.
- [73] M. Jiang, X. Yuan, H. Li, and J. Wang, "A new fuzzy system based on rectangular pyramid," *Sci. World J.*, vol. 2015, pp. 1–11, Mar. 2015.
- [74] A. Gonzalez and R. Perez, "Completeness and consistency conditions for learning fuzzy rules," *Fuzzy Sets Syst.*, vol. 96, no. 1, pp. 37–51, May 1998.
- [75] K. Nozaki, H. Ishibuchi, and H. Tanaka, "A simple but powerful heuristic method for generating fuzzy rules from numerical data," *Fuzzy Sets Syst.*, vol. 86, no. 3, pp. 251–270, Mar. 1997.
- [76] T. Chen, C. Shang, P. Su, and Q. Shen, "Induction of accurate and interpretable fuzzy rules from preliminary crisp representation," *Knowl.-Based Syst.*, vol. 146, pp. 152–166, Apr. 2018.
- [77] J. Jantzen, *Design Of Fuzzy Controllers*. Lyngby, Denmark: Technical Univ. of Denmark, 1998.
- [78] P. J. King and E. H. Mamdani, "The application of fuzzy control systems to industrial processes," *Automatica*, vol. 13, no. 3, pp. 235–242, May 1977.
- [79] N. V. Srikanth and D. V. Kumar, "Investigation of stability of fuzzy logic based power system stabilizers using phase-plane analysis," in *Proc. Nat. Power Syst. Conf.*, 2004, pp. 408–413.
- [80] W.-J. Wang and H.-R. Lin, "Fuzzy control design for the trajectory tracking in phase plane," *IEEE Trans. Syst., Man, Cybern. A, Syst. Humans*, vol. 28, no. 5, pp. 710–719, Sep. 1998.
- [81] R. Kannan and J. Kanagaraj, "Performance analysis of an induction motor drive using fuzzy variable structure control," *Aust. J. Basic Appl. Sci.*, vol. 7, no. 12, pp. 51–59, 2013.
- [82] H.-X. Li and H. B. Gatland, "A new methodology for designing a fuzzy logic controller," *IEEE Trans. Syst., Man, Cybern.*, vol. 25, no. 3, pp. 505–512, Mar. 1995.
- [83] L. Zheng, "A practical guide to tune of proportional and integral (PI) like fuzzy controllers," in *Proc. IEEE Int. Conf. Fuzzy Syst.*, Mar. 1992, pp. 633–640.
- [84] O. Kammouh, A. Z. Noori, V. Taurino, S. A. Mahin, and G. P. Cimellaro, "Deterministic and fuzzy-based methods to evaluate community resilience," *Earthq. Eng. Eng. Vib.*, vol. 17, no. 2, pp. 261–275, Apr. 2018.
- [85] A. Gegov, "Rule based systems and networks: Deterministic and fuzzy approaches," in *Proc. IEEE 8th Int. Conf. Intell. Syst.*, Sep. 2016, pp. 316–321.
- [86] R. Sadeghian and B. Gholamaliei, "Fuzzy rules extraction based on deterministic data (case study: Bank's customers rating)," *Jordan J. Mech. Ind. Eng.*, vol. 8, no. 6, pp. 409–415, 2014.
- [87] H. Pomares, I. Rojas, J. Ortega, J. Gonzalez, and A. Prieto, "A systematic approach to a self-generating fuzzy rule-table for function approximation," *IEEE Trans. Syst., Man, Cybern. B, Cybern.*, vol. 30, no. 3, pp. 431–447, Jun. 2000.
- [88] F. Cheong and R. Lai, "On simplifying the automatic design of a fuzzy logic controller," in *Proc. Annu. Meeting North Amer. Fuzzy Inf. Process. Soc.*, Jun. 2002, pp. 481–487.
- [89] M. Masiala, "Self-tuned indirect field oriented controlled IM drive," Ph.D. dissertation, Dept. Power Eng. Power Electron., Univ. Alberta, Edmonton, AB, Canada, 2010.
- [90] J. V. Dos Reis, T. R. Raddo, A. L. Sanches, and B.-H. V. Borges, "Comparison between Mamdani and Sugeno fuzzy inference systems for the mitigation of environmental temperature variations in OCDMA-PONs," in *Proc. 17th Int. Conf. Transparent Opt. Netw. (ICTON)*, nos. 5–9, Jul. 2015, pp. 1–4.
- [91] C. Sivapragasam, G. Vasudevan, P. Vincent, P. Sugendran, M. Marimuthu, and S. Seenivasakan, "Rule reduction in fuzzy logic for better interpretability in reservoir operation," *Hydrol. Processes*, vol. 21, no. 21, pp. 2835–2844, Oct. 2007.
- [92] D. Andone, "Fuzzy rule base complexity reduction: A survey," in *Proc. 15th Int. Conf. Control Syst. Comput. Sci.*, 2015, pp. 1–5.
- [93] K. C. Ng and Y. Li, "Reduced rule-base and direct implementation of fuzzy logic control systems," *IFAC Proc. Volumes*, vol. 29, no. 1, pp. 2484–2489, Jun. 1996.
- [94] M. Ramirez-Gonzalez and O. P. Malik, "Simplified fuzzy logic controller and its application as a power system stabilizer," in *Proc. 15th Int. Conf. Intell. Syst. Appl. Power Syst.*, Nov. 2009, pp. 1112–1115.
- [95] F. Rafiq, "A simplified fuzzy logic liquid level control system," *J. Intell. Comput.*, vol. 7, no. 4, pp. 135–144, 2016.



- [96] R. Alcalá, J. Alcalá-Fdez, and F. Herrera, "Fuzzy rule reduction and tuning of fuzzy logic controllers for a HVAC system," in *Fuzzy Applications in Industrial Engineering*, vol. 201. Berlin, Germany: Springer, 2006, pp. 89–117.
- [97] M. K. Ciliz, "Rule base reduction for knowledge-based fuzzy controllers with application to a vacuum cleaner," *Expert Syst. Appl.*, vol. 28, no. 1, pp. 175–184, Jan. 2005.
- [98] Z. Tir, O. P. Malik, and A. M. Eltamaly, "Fuzzy logic based speed control of indirect field oriented controlled double star induction motors connected in parallel to a single six-phase inverter supply," *Electr. Power Syst. Res.*, vol. 134, pp. 126–133, May 2016.
- [99] A. A. Sadiq, G. A. Bakare, E. C. Anene, and H. B. Mamman, "A fuzzy-based speed control of DC motor using combined armature voltage and field current," in *Proc. 3rd IFAC Int. Conf. Intell. Control Automat. Sci.*, 2013, pp. 387–392.
- [100] J. A. Ali, M. A. Hannan, A. Mohamed, and M. G. M. Abdolrasol, "Fuzzy logic speed controller optimization approach for induction motor drive using backtracking search algorithm," *Measurement*, vol. 78, pp. 49–62, Jan. 2016.
- [101] R. Goswami and D. Joshi, "Performance review of fuzzy logic based controllers employed in brushless DC motor," *Procedia Comput. Sci.*, vol. 132, pp. 623–631, 2018.
- [102] H. Bouzeria, C. Fetha, T. Bahi, I. Abadlia, Z. Layate, and S. Lekhchine, "Fuzzy logic space vector direct torque control of PMSM for photovoltaic water pumping system," *Energy Procedia*, vol. 74, pp. 760–771, Aug. 2015.
- [103] H. Sathishkumar and S. S. Parthasarathy, "A novel neural network intelligent controller for vector controlled induction motor drive," *Energy Procedia*, vol. 138, pp. 692–697, Oct. 2017.
- [104] M. N. Uddin and M. M. I. Chy, "A novel fuzzy-logic-controller-based torque and flux controls of IPM synchronous motor," *IEEE Trans. Ind. Appl.*, vol. 46, no. 3, pp. 1220–1229, Mar. 2010.
- [105] M. A. Hannan, J. A. Ali, A. Hussain, F. H. Hasim, U. A. U. Amirulddin, M. N. Uddin, and F. Blaabjerg, "A quantum lightning search algorithm-based fuzzy speed controller for induction motor drive," *IEEE Access*, vol. 6, pp. 1214–1223, 2018.
- [106] M. N. Uddin and J. Khasoo, "Fuzzy logic-based efficiency optimization and high dynamic performance of IPMSM drive system in both transient and steady-state conditions," *IEEE Trans. Ind. Appl.*, vol. 50, no. 6, pp. 4251–4259, Apr. 2014.
- [107] Z. M. Elbarbary, E. E. El-Kholy, and H. A. Hamed, "Comments on 'A performance investigation of a four-switch three-phase inverter-fed IM drives at low speeds using fuzzy logic and PI controllers,'" *IEEE Trans. Power Electron.*, vol. 33, no. 9, pp. 8187–8188, Sep. 2018.
- [108] S. Bolognani and M. Zigliotto, "Hardware and software effective configurations for multi-input fuzzy logic controllers," *IEEE Trans. Fuzzy Syst.*, vol. 6, no. 1, pp. 173–179, Feb. 1998.
- [109] P. C. Shill, Y. Maeda, and K. Murase, "Optimization of fuzzy logic controllers with rule base size reduction using genetic algorithms," in *Proc. IEEE Symp. Comput. Intell. Control Automat. (CICA)*, Sep. 2013, pp. 57–64.
- [110] H. Asgharpour-alamdari, "A fuzzy-based speed controller for improvement of induction motor's drive performance," *Iran. J. Fuzzy Syst.*, vol. 2, no. 1, pp. 61–70, 2016.
- [111] M. J. Hossain, M. A. Hoque, and K. K. Islam, "Simplified fuzzy control for flux-weakening speed control of IPMSM drive," *Adv. Fuzzy Syst.*, vol. 2011, pp. 1–9, Jul. 2011.
- [112] S. Angalaeswari, O. V. G. Swathika, V. Ananthkrishnan, S. Angalaeswari, V. Ananthkrishnan, K. Jamuna, A. Pina, P. Ferrão, J. Fournier, B. Lacarrière, and O. Le Corre, "Efficient power management of grid operated microgrid using fuzzy logic controller (FLC)," in *Proc. 1st Int. Conf. Power Eng., Comput. Control (PECCON)*, vol. 117, 2017, pp. 268–274.
- [113] D. K. Sambariya and R. Prasad, "A novel fuzzy rule matrix design for fuzzy logic-based power system stabilizer," *Electr. Power Compon. Syst.*, vol. 45, no. 1, pp. 34–48, Jan. 2017.
- [114] M. G. Ion Iancu, "Fuzzy Logic Controller Based on Association Rules," *Ann. Univ. Craiova, Math. Comput. Sci. Ser.*, vol. 37, no. 3, pp. 12–21, 2010.
- [115] T. Yamakawa, "Hardware implementation of fuzzy logic controller-designability, stability and robustness," in *Control System Engineering*, P. J. A. El-Osery, Ed. Cham, Switzerland: Springer, 2015, pp. 261–273.
- [116] E. H. Mamdani, "Application of fuzzy logic to approximate reasoning using linguistic synthesis," *IEEE Trans. Comput.*, vol. C-26, no. 12, pp. 1182–1191, Dec. 1977.
- [117] T. Takagi and M. Sugeno, "Derivation of fuzzy control rules from human Operator's control actions," *IFAC Proc. Volumes*, vol. 16, no. 13, pp. 55–60, Jul. 1983.
- [118] N. Farah, M. H. N. Talib, N. S. M. Shah, Q. Abdullah, Z. Ibrahim, J. M. Lazi, and A. Jidin, "A novel self-tuning fuzzy logic controller based induction motor drive system: An experimental approach," *IEEE Access*, vol. 7, pp. 68172–68184, 2019.
- [119] H. Sugimoto and E. Ohno, "A new induction motor drive system with linear transfer function," *Electr. Eng. Jpn.*, vol. 103, no. 1, pp. 47–55, Jan. 1983.
- [120] S.-C. Wang and Y.-H. Liu, "A modified PI-like fuzzy logic controller for switched reluctance motor drives," *IEEE Trans. Ind. Electron.*, vol. 58, no. 5, pp. 1812–1825, May 2011.
- [121] H.-X. Li and H. B. Gatland, "Conventional fuzzy control and its enhancement," *IEEE Trans. Syst., Man, Cybern. B, Cybern.*, vol. 26, no. 5, pp. 791–797, Oct. 1996.



**QAZWAN A. TARBOSH** was born in Taiz, Yemen. He received the bachelor's degree in electrical and electronic engineering from Universiti Tun Hussein Onn Malaysia (UTHM), in 2013, and the master's degree of science in electrical and electronic engineering from UTHM, in 2015. He is currently pursuing the Ph.D. degree. His research interests are in control systems, wireless technology, and microwaves.



**ÖMER AYDOĞDU** is currently an Associate Professor with the Faculty of Engineering and Natural Sciences, Department of Electrical and Electronics Engineering and Department of Electrical Machinery, Konya Technical University.



**NABIL FARAH** was born in Yemen, in 1990. He received the bachelor's degree in electrical engineering (power electronics and drives) from Universiti Teknikal Malaysia Melaka, in 2015, and the master's degree in electrical engineering from Universiti Teknikal Malaysia Melaka. He is currently pursuing the Ph.D. degree in electrical engineering. His current research interests are in self-tuning fuzzy logic controller of AC Motor drives and predictive control of induction motor drives.



**MD HAIRUL NIZAM TALIB** was born in Malaysia, in 1976. He received the B.S. degree in electrical engineering from the Universiti Teknologi Malaysia (UTM), Johor, Malaysia, in 1999, the M.S. degree in electrical engineering from the University of Nottingham, Nottingham, U.K., in 2005, and the Ph.D. degree from the Universiti Teknikal Malaysia Melaka (UTeM), Malaysia, in 2016. He is currently a Senior Lecturer with UTeM. His main research interests include power electronics, fuzzy logic control, and motor drives.



**ADEEB SALH** received the bachelor's degree in electrical and electronic engineering from IBB University, IBB, Yemen, in 2007, and the master's degree in electrical and electronic engineering from University Tun Hussein Onn Malaysia, Malaysia, in 2014, where he is currently pursuing the Ph.D. degree with the Faculty of Electrical and Electronic Engineering.



**FUAD ALHAJ OMAR** received the M.Sc. and Ph.D. degrees in electronic engineering from the University of Aleppo, in 2009 and 2014, respectively. Upon completion of his Ph.D., he started conducting the second Ph.D. at Selçuk University, Turkey. During Summer 2019, he was a Visiting Scholar at the School of Engineering and Materials Science, Queen Mary University of London, U.K. His research interests include renewable energy, power electronics, and control systems and automation.



**NIHAT ÇANKAYA** was born in Konya, Turkey, in 1974. He was graduated from the Electrical and Electronics Engineering Department, Selçuk University, in 1997, and received the M.Sc. degree in electrical and electronics engineering from Necmettin Erbakan University, Turkey, in 2017. As an Engineer and Production Manager, he has worked in various factories in process control, powder handling, industrial automation, breakdown maintenance, electrical energy production, cogeneration, renewable energy, and so on. He currently works as a Lecturer at Necmettin Erbakan University. He has been involved in assembly, disassembly, and installation of various production lines at domestic and foreign factories. He was involved in the preparation, projecting, installation, commissioning, and operation of the feasibilities of factories and power generation facilities.



**AKIF DURDU** received the B.Sc. degree in electrical and electronics engineering from Selçuk University, in 2001, and the Ph.D. degree in electrical and electronics engineering from the Middle East Technical University (METU), in 2012. He has been an Assistant Professor with the Electrical and Electronics Engineering Department, Konya Technical University, since 2013. His research interests include robot manipulators, human-robot interaction, autonomous robotics systems, and sensor networks.

• • •