

Received December 30, 2019, accepted January 14, 2020, date of publication February 13, 2020, date of current version February 26, 2020.

Digital Object Identifier 10.1109/ACCESS.2020.2973771

# Obsea: A Decadal Balance for a Cabled Observatory Deployment

JOAQUIN DEL-RIO<sup>1</sup>, (Member, IEEE), MARC NOGUERAS<sup>1</sup>, DANIEL MIHAI TOMA<sup>1</sup>, ENOC MARTÍNEZ<sup>1</sup>, CAROLA ARTERO-DELGADO<sup>1</sup>, IKRAM BGHIEL<sup>1</sup>, MARC MARTINEZ<sup>1</sup>, JAVIER CADENA<sup>1</sup>, ALBERT GARCIA-BENADI<sup>1</sup>, DAVID SARRIA<sup>1</sup>, JACOPO AGUZZI<sup>2</sup>, IVAN MASMITJA<sup>1</sup>, MATIAS CARANDELL<sup>1</sup>, JOAQUIM OLIVE<sup>1</sup>, SPARTACUS GOMARIZ<sup>1</sup>, PEP SANTAMARIA<sup>1</sup>, AND ANTONI MÀNUEL LÀZARO<sup>1</sup>

<sup>1</sup>SARTI, Electronics Department, Universitat Politècnica de Catalunya (UPC), 08800 Vilanova i la Geltrú, Spain

<sup>2</sup>Instituto de Ciencias del Mar (ICM) - Consejo Superior de Investigaciones Científicas (CSIC), 08003 Barcelona, Spain

Corresponding author: Joaquin del-Rio (joaquin.del.rio@upc.edu)

This work was supported in part by the Spanish Ministry of Education and Science (MEC) with the project Redes de sensores submarinos autónomos y cableados aplicados a la monitorización remota de indicadores biológicos under Grant TEC2017-87861-R, and part by Generalitat de Catalunya with the Project Sistemas de Adquisición Remota de datos y Tratamiento de la Información en el Medio Marino (SARTI-MAR) under Grant 2017 SGR 371. Researchers want to acknowledge the support of the Associated Unit Tecnoterra composed by members of Universidad Politécnica de Cataluña (UPC) and the Consejo Superior de Investigaciones Científicas (CSIC). This work used the EGI infrastructure with the dedicated support of INFN-CATANIA-STACK.

**ABSTRACT** The study of the effects of climate change on the marine environment requires the existence of sufficiently long time series of key parameters. The study of these series allows both to characterize the range of variability in each particular region and to detect trends or changes that could be attributed to anthropogenic causes. For this reason, networks of permanent cabled observation systems are being deployed in the ocean. This paper presents a balance of a decade of activity at the OBSEA cabled observatory, as an example of ocean monitoring success and drawbacks. It is not the objective of this article to analyze the scientific and technical aspects already presented by the authors in different publications (Table 4). We will evaluate the overall experience by retracing the different steps of infrastructure deployment and maintenance, focusing on routines for *in situ* control, damages experienced, breakdowns and administrative constraints by local administrations. We will conclude by providing a set of guidelines to improve cabled observatories scientific outreach, societal projection, and economic efficiency. As a result of this work, a 10-years dataset has been published in Pangaea that is available for the community.

**INDEX TERMS** Cabled observatories, multidisciplinary observation, coastal ocean monitoring, underwater imaging, european multidisciplinary seafloor and water column observatory (EMSO), JERICO-RI.

## I. SEABED OBSERVATORIES

Understanding the link between natural variability and anthropogenic effects is essential to quantify and then predict the magnitude and impact of future climate changes. Processes such as ocean carbon cycling and sequestration and associated ocean acidification, eutrophication coupled with hypoxic and anoxic events, ecosystem dynamics related to species rhythmic behavioral displacements, and harmful algal blooms are becoming increasingly more important as the world's population continues to grow, especially in coastal areas. In this context, multidisciplinary underwater cabled

The associate editor coordinating the review of this manuscript and approving it for publication was X. Huang<sup>1</sup>.

observatories provide real-time data for marine observations by keeping a web database with historical values [1]–[5]. These observatories can acquire large amounts of high resolution data and are able to analyze annual tendencies and singular events, providing new opportunities of research and development in research projects as well as technology innovation.

### A. THE NEED FOR NEW TRANSDISCIPLINARY RESEARCH

Experimental marine research requires a growing volume of data with better temporal resolution from coastal areas to the deep-sea than what can be acquired by technologies associated to oceanographic vessels, such as ROVs and AUVs [6]. In order to satisfy these requirements, high frequency, and

continuous, time series of multiparametric biological and environmental data must be acquired *in situ* in a remotely operated fashion.

The incorporation of marine observations using satellites represented an important step forward with regard to the global information on ocean characteristics but, unfortunately, the observation only occurs at the ocean surface. Those data have been anyway successfully related to water column and seabed processes in desired locations thanks to networks of fixed or drifting buoys (e.g., moored assets and Argo floats) installed. This kind of measurements has ensured that a larger number of space-time scales related to important processes that characterize the dynamics of oceanographic systems is more easily recognizable.

Although these methodologies are important and provide valuable results, they are costly and inadequate when analyzing the role of energy fluxes in shaping local populations dynamics (i.e. the effects benthopelagic coupling on local species density and biomass as a proxy of ecosystem functioning and productivity). A variety of physical, geological, chemical, biological, etc. parameters need to be monitored in a concomitant fashion in order to understand, for example, the effects of surface dynamic processes at the geographic scale on coastal ecosystems. In order to carry out systematic marine research, other technologies and instruments that allow active processes to be recorded over a long period of time (ideally up to 10 years or more) are required. This can only be accomplished through multi-scale (spatial and temporal) networks of autonomous sensors and sensor platforms which collect and then transmit data to laboratories in real-time [6].

In this framework, the current implementation of the expandable platform OBSEA comprises two nodes in shallow water (20m depth), and in the near future it will be extended to greater depths of the local continental margin. A network is being created with additional nodes covering different areas of relevance for marine commercial fishery exploitation and conservation, allowing synchronous data replication and scalability. Presently, the observatory network has been implemented by connecting a surface buoy (LMV BMG1030) enabling a redundant radio link through a UMTS 3G/4G or Iridium satellite connection. All the instruments are transparently made accessible to users through a TCP/IP connection [7].

Many different fields of marine sciences will benefit from the development and installation of fixed underwater observatories; for example, the study of large scale circulation variability, biochemical cycles (nutrients balance, carbon flows, etc.), dynamics of marine ecosystems and internal and external geo-dynamic processes, studies of singular and extreme events (storms, formation of discharge plumes in estuaries, blooming of harmful algae, earthquakes and tsunamis, etc.). The measurement technologies of underwater observatories allow data to be obtained with sufficient time resolution to register singular events essential in dynamic processes and obtain *in situ* information to analyze a specific phenomenon.

## B. OBJECTIVES

This paper presents a balance of a decade of activity as an example of monitoring success and drawbacks at the OBSEA (OBservatory of the Sea OBservatorio Submarino Expandible cAbleado; [www.obsea.es](http://www.obsea.es)) cabled observatory. We will evaluate the overall experience by retracing the different steps of infrastructure deployment and maintenance, focusing on routines for *in situ* control, damages experienced, breakdowns and administrative constraints by local administrations. We will conclude by providing a set of guidelines to improve cabled observatories scientific outreach, societal projection, and economical efficiency.

In this paper, the OBSEA observatory will be introduced (design, construction, permits for installation, maintenance, main research lines and operation results [8]).

## II. SCIENTIFIC CONTEXT FOR OBSEA DEPLOYMENT AND MAINTENANCE

Continuous monitoring of the most relevant environmental parameters can be achieved through the establishment of a global network of seabed observatories. These observatories have energy supply and data communication capabilities, complemented with autonomous sensors and mobile platforms distributed in the area under study. The measurements of the water column in seabed observatories are a perfect complement to satellite measurement systems, since it provides the capability to calibrate remotely sensed satellite measurements [9].

Understanding the Earth and its oceans means investigating processes as they occur. A scientifically powerful component of the observatory concept is the long time series collection of multiple variables at a single location. These multidisciplinary data sets will enable the enhancement of more traditional observation methods and will provide substantial benefits to many disciplines, such as geophysics [3], physical oceanography [10] and biology [11]. For scientists, new opportunities to study interrelated processes on time scales ranging from seconds to decades can be achieved thanks to the features of the seabed observatories.

These technologies are already being developed in some countries such as the USA, with the Ocean Observatories Initiative [9] and the Monterey Accelerated Research System, the NEPTUNE (*North-East Pacific Time-Series Underwater Networked Experiments*) and VENUS (*Victoria Experimental Network Under the Sea*) in Canada [12], DONET (*Dense Oceanfloor Network system for Earthquakes and Tsunamis*) in Japan [13], Aloha in Hawaii [14] and projects promoted by the European Union such as ESONET (*NoE (network of excellence) FP6-2005-Global-4 - ESONET 036851-2 European Seas Observatory NETWORK*). The objective of ESONET was to establish the basis for the development of marine components for the GMES project (Global Monitoring for Environment & Security) that will facilitate the long-term establishment of multi-disciplinary marine stations situated in key locations along the European ocean margin.

TABLE 1. European projects list.

Project	Reference	Duration
<b>ESONET:</b> European Seas Observatory NETwork	FP6-2005-Global N°036851-2.	2007-2009
<b>JERICO:</b> Towards A Joint European Research Infrastructure Network For Coastal Observatories	FP7 Capacities Research Infrastructures Programme Number 262584	2012-2015
<b>MARITECH:</b> Marine Technology Instrumentation	Erasmus 2013-1-ES1-ERA10-74536	2013-2014
<b>FixO3:</b> Fixed Point Open Ocean Observatories	FP7 Capacities/Research Infrastructures N°312463	2014-2016
<b>METEOMET2:</b> Sensors characteristics for the generation of higher quality climate data.	European Metrology Research Programme	2014-2016
<b>NeXOS:</b> Next generation, Cost-effective, Compact, Multifunctional Web Enabled Ocean Sensor Systems Empowering Marine, Fisheries Management	FP7-OCEAN-2013 N°: 614102	2014-2017
<b>EMSODEV:</b> EMSO implementation and operation: DEvelopment of instrument	H2020-676555	2015-2018
<b>JERICONEXT:</b> Joint European Research Infrastructure network for Coastal Observatory	H2020-654410-JERICO-NEXT	2015-2019
<b>EMSOLINK:</b> Implementation of the Strategy to Ensure the EMSO ERIC’s Long-term Sustainability	H2020-INFRADEV-2016-1 CSA Grant Agreement: 731036- 276	2017-2019
<b>MELOA:</b> Multi-purpose/Multi-sensor Extra Light Oceanography Apparatus	H2020-776825-MELOA	2017- 2021

The ESONET community was actively involved in the FP7-funded EUROSITES collaborative project. EUROSITES integrated 9 deep-ocean observatories sited in waters off the continental shelf at depths of over 1000 m, taking different types of measurements from the sea surface to the sea floor. The project was coordinated by the National Oceanography Centre in Southampton [15].

Some ESONET partners, under the umbrella EMSO (European Multidisciplinary Seafloor and water column Observatory) ERIC (European Research Infrastructure Consortium), are currently active in developing shallow-water test sites [8]. Easy access to these sites enables the implementation of demonstration activities and to perform test bed experiments for different types of equipment, with a view to their subsequent deployment in the more extreme environment encountered in the deep ocean.

Table 1 shows a list of the European (FP7, H2020) research projects in which OBSEA has been involved in the past as well as in current projects. In this context, the infrastructure OBSEA under Calls for Transnational Access (TNA) has been accessed 828 days (16-02-2015 to 31-08-2017) in the FixO3 (FP7) project, and 492 days (5-02-2017 to 9-11-2018) in the JericoNext Project.

### III. THE INSTALLATION PLANING

The overall objective of the ESONET NoE was to create an organization able to implement, operate and maintain a sustainable underwater observation network, extending into deep water, capable of monitoring biological, geo-chemical, geological, geophysical and physical processes occurring throughout the water column and on the sea floor.

As a partner of ESONET, UPC showed the benefits of deploying a low-cost underwater laboratory in shallow waters (20m depth), as a test-site (ESONET labeled), before starting the construction and installation of laboratories at higher depths which are costlier to implement and maintain.

The main requirements defined for the design of OBSEA were:

- Interoperability and flexibility to connect any instrument.
- Permanent availability of energy to power equipment.
- Connection and disconnection of submerged instruments.
- Real time connection and high data throughput instruments.
- Remote access to the observations of the seabed.
- Ability to manage samples.
- Quick and easy access to the data.

With these in mind, the research group SARTI (Remote Acquisition and Data Processing Systems) from Universitat Politècnica de Catalunya (UPC) developed and constructed a low-cost underwater observatory in shallow waters (20m depth) near the coast.

Firstly, a suitable location at sea for the construction and installation of the observatory was searched. The selection of the area was conditioned by the physical location of the research group and the scientific interest; SARTI operates in Vilanova i la Geltrú, a fishing and commercial harbour 50 km south of Barcelona, on the Garraf coast. After selecting the area, the specific site location (longitude, latitude) was considered, including the distance in miles from the coast, as this determines the length of the cable, and consequently its cost. Equally important was the compatibility with the fisheries that operate in the area, since the installation of a submarine cable presents restrictions to trawling fishing methods (Figure 1).

#### A. LOCATION OF THE OBSERVATORY AND WAYS TO INTERCONNECT THE SUBSEA STATION

The location selected for the OBSEA was along the coast of Garraf, an area declared as a Site of Community Importance (SCI), a Special Protection Area for Birds (SPA), and a member of Natura 2000 (ES5110020). The coast of Garraf lies between the coastal towns of Cunit and Castelldefels and is mainly characterized by the presence of important seagrass, such as *Posidonia oceanica*, endemic to the Mediterranean

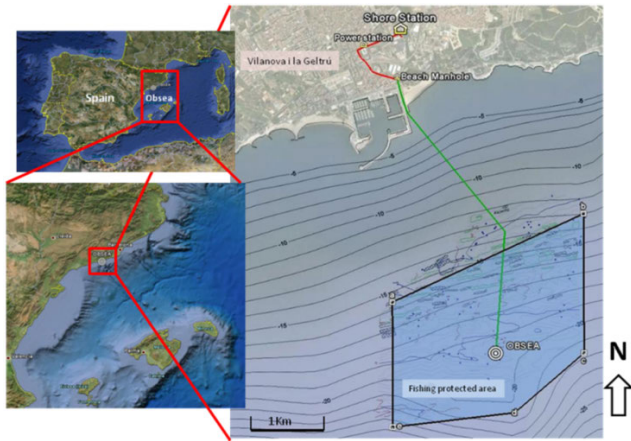

**FIGURE 1.** Location of the OBSEA observatory. Relevant sites: Shore Station, Beach Manhole and the Subsea Station. The artificial reefs area is blue coloured. In this area the point shows where the two junction boxes are installed, separated by 200m.

Sea, and *Cymodocea nodosa* in lower concentrations. The sea plays a major role in the biotic balance of the Garraf ecosystem, with a big ecological impact and biomass production possibilities productive possibilities. This role, however, is often barely considered and the sea suffers great stresses due to its vulnerability. The region “Costas del Garraf” (ES5110020) is in the area of the Metropolitan Region of Barcelona, which means that it is under great ambient pressure. This proximity, however, has an advantage, since having a well-managed and ecologically valuable space can provide the local population with a better quality of life. Installing a cabled observatory means that the data needed to support effective decisions for a better conservation and management of the coast can be obtained and maintained. The location in the region *Costas del Garraf* is of particular interest given the need to establish policies for the protection and management of Natura 2000 spaces.

The existence of reliable and continuous data and its correlation with environmental factors, natural resources and biodiversity will allow scientific studies of the influence of climate changes on the coastline to be carried out and facilitate decision-making in the areas of prevention and mitigation. The seabed observatory OBSEA is part of the proposal Coastal Observatory, led by the Consortium *dels Colls Miralpeix* which coordinates, together with UPC-SARTI, other proposals and projects, including the monitoring of sea-grass meadows, the monitoring of the appearance of *Caulerpa Racemosa*, some invasive algae and the promotion of biodiversity by the Garraf Park artificial reef project [16].

The OBSEA platform consists of two stations: The Shore Station and the Subsea Station. To interconnect both the Shore Station and the Subsea Station, a terrestrial cable in the coast was required with the corresponding connection to the submarine cable. Figure 2 shows a general diagram. Terrestrial and submarine cables are interconnected in a man-hole close to the sea, and the submarine cable is led to the sea through a pipeline. The Shore Station is located in

two separate buildings at the University campus, interconnected by optical fiber; it houses the management and data servers in charge of status monitoring and data collection, and the power supply equipment. The Subsea Station has all the oceanographic instruments and related electronics for power supply, communications and control. The data servers on shore continually store the information and provide the interface with the network giving controlled access to the scientific community.

## B. ADMINISTRATIVE AUTHORIZATIONS

In order to install the different cables and to occupy public domain, different authorizations had to be obtained from the local authorities (City of Vilanova), the autonomic authorities (Generalitat de Catalunya) and the state authorities (Government of Spain). Without these the observatory could not have been installed.

The Local Administration of the Vilanova City Council (Ajuntament de Vilanova i la Geltrú) granted permission to carry out the necessary road works for the cable duct in the terrestrial sections. Application for a license for occupation of public domain, including underground rain and fluvial thoroughfares (dry rivers *Pastera's Torrent* and the *La Piera's Torrent*) to the sea, was sought under the umbrella of a cooperation agreement between the City Hall and the University itself.

The consenting process with the Autonomic Administration to deploy a cabled observatory and obtain a public domain lease for an extended period of time can be complex and lengthy. In the case of OBSEA, the process was indeed long and complicated. The process for the authorization began in 2007; the positive response, authorizing occupation and use of public domain for 30 years, was received in 2014. From 2007 to 2014 there was a provisional authorization.

The Catalan Autonomous Government (Generalitat de Catalunya) managed the relationship with different authorities such as the: Department of Agriculture and Food, Fishing and Marine Activities and Commission for Rural Activities which oversees the relationship with fishing activities, and grants permissions to carry out underwater scientific research; the Department of the Environment and Housing, which includes the Catalan Water Authorities, from which permission was requested to occupy public domain (bed of dry rivers *La Piera* and *Pastera*); and, finally, the Department of Urban Development and Public Works (Ports, Airports and Coasts Governmental Agency), from which an authorization to lay the cable along the coastal zone was requested.

Finally, the Spanish Government Administration granted consent to deploy the submarine node in the public marine-terrestrial domain in the municipality of Vilanova. The Ministry of the Environment has currently transferred this competence to the Department of Territory and Sustainability, and subsequently notifies the Navy's Hydrographic Institute (Ministry of Defense) for inclusion of information

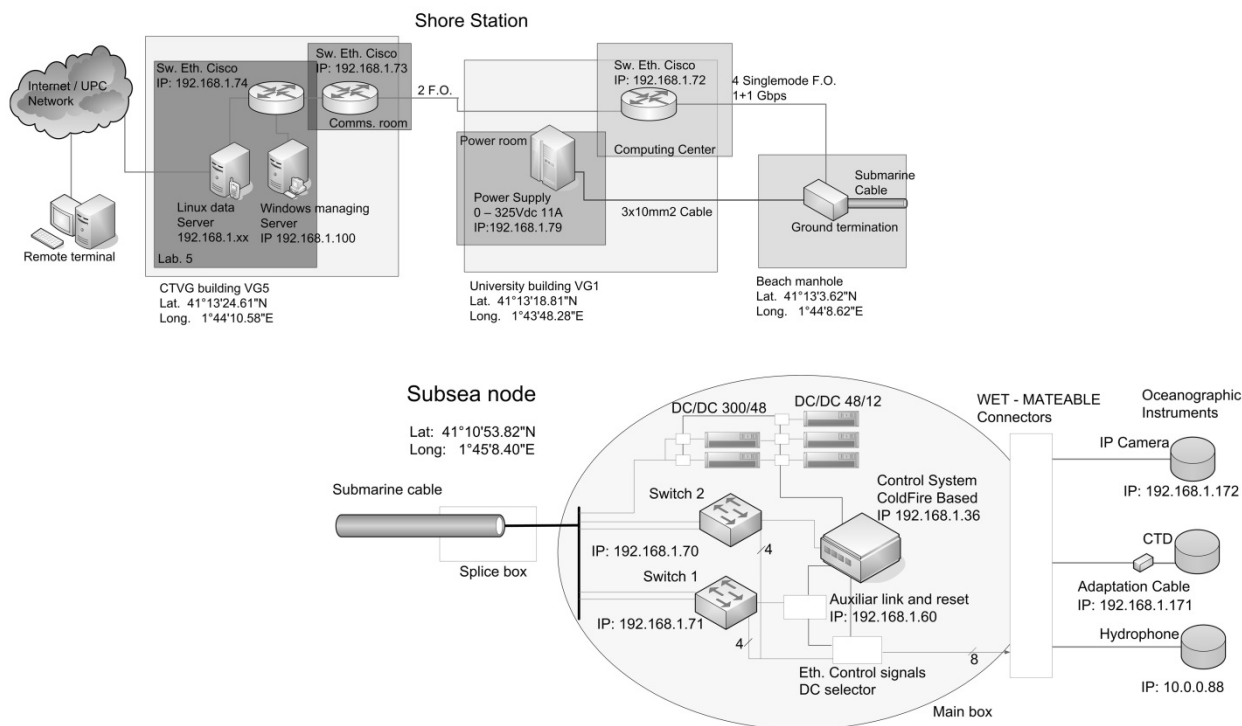

FIGURE 2. OBSEA Shore Station and Subsea node diagram.

in nautical charts and related navigational warnings, and the local branch of the Maritime Ministry of Development in Vilanova.

IV. FEATURES OF THE PLATFORM

OBSEA was designed as a test observatory in a way that can be extended in the future, in order to form a seafloor observatory network that covers the several sites of interest. In periods of maintenance and / or breakdown of the submarine cable, and to continue the acquisition of data, the OBSEA subsea station has been complemented with surface buoys that provide a link through UMTS (Universal Mobile Telecommunications System) or an Iridium satellite connection (figure 2).

The subsea station is composed of the junction box (main box), the cable termination box (splice box) and the oceanographic instruments. The junction box is a stainless steel cylindrical vessel 400 mm in diameter, 1000 mm in length, thickness of 5 mm (Figure 3) and designed to withstand depths of 300 m [17].

The minimum radius of curvature of the submarine cable causes handling constraints; an underwater termination box was built to circumvent these and obtain a flexible underwater connection.

Figure 4 shows the termination box, a cylinder used to interconnect the rigid submarine cable from shore with the flexible cable (yellow cable) to the underwater node (junction box).

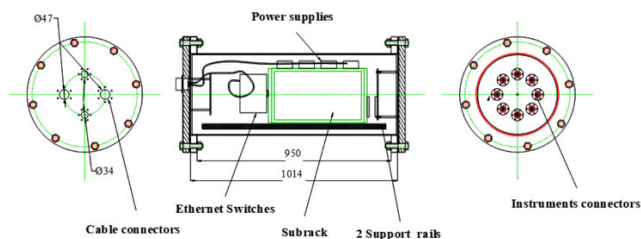

FIGURE 3. Junction Box picture and dimensions. Cylinder designed to resist the pressure of a 300 m water column. Interface between the underwater cable and marine instruments connected to the observatory.



FIGURE 4. Left: Termination box. Right: Cable deployment with termination box unit.

All this equipment is placed in a 4.6 m<sup>2</sup> stainless steel structure designed to be stable and to protect all the instrumentation from unauthorized manipulation, employing sacrificial anodes for galvanic protection; this structure is still operational after 10 years underwater. The junction box contains the power, communications and control electronics of

TABLE 2. OBSEA instrumentation list.

Instrument	Measured Parameter(s)	Elevation/Depth	Sampling frequency	Frequency of data recovery
Seabird SBE16plusV2	Water Temperature, Conductivity, Depth, Sound velocity, Salinity.	-20 m	20 s	Real-time
Seabird SBE37SMP	Water Temperature, Conductivity, Depth, Sound velocity, Salinity.	-20m	20 s	Real-time
Underwater camera OPT-06	Subsea images	-20m	10 frames/s	Real-time
Hydrophone Bjorge Naxys	Sound	-20m	Up to 768 kS/s	Real-time
Nortek AWAC	Water Currents, Waves height & direction, turbidity, chlorophyll	-20m	10 minutes	Real-time
Nanometrics Broadband sismometer Trillium 120P	Tectonic movement and vibration	-20m	Up to 175 Hz	Real-time
Buoy weather station Airmar 150WX	Air temperature, pressure, wind speed and direction	5 m	30s	Real-time
Mobotix M24 buoy camera	Surface images	5m	12 frames per second	Real-time
Land Davis Vantage Pro2 Weather Station	Air temperature, humidity, pressure, wind speed and direction, rain	14m	10 minutes	Real-time
LICOR LI-820 CO2 Gas Analyzer	CO2 Concentration in air	14 m	30 s	Real-time



FIGURE 5. Location of the Subsea station beside an artificial reef.

the node as well as the underwater connectors for the umbilical cable and oceanographic instruments (Table 2) [18]. The location of the Subsea station, close to an artificial reef, is shown in Figure 5. For transmitting power, the option HVDC (high-voltage direct current) has inherent properties that make it much more convenient and efficient than HVAC (high-voltage alternating current). The most significant difference in HVAC is that the high capacitance of the cable generate considerable reactive current. The capacitance is the ability of an insulating material between conductors to store electricity when there is a voltage difference between the two conductors. In order to minimize capacitance, it would be necessary to increase the cable section, which would be technically and economically non-viable. In HVDC, one of the conductors is in this case the sea, seabed and soil, as well as the cable armoring and sheathing, and the other the single copper conductor in the cable. If the cable's armoring and sheathing are broken, a short circuit will occur at the fault point where the sea water gets in contact with the copper conductor.

Communication between nodes and the shore station is carried out through two redundant 1 Gbps fiber optic links with 1 + 1 configuration using TCP/IP protocols and synchronization over PTP IEEE Std 1588. The first subsea station has a power supply that accepts power from 80 to 370VDC by means of redundant 1 + 1 150W DC/DC converters. The current design supports up to 8 wet mateable external instruments each powered by up to 3 A at 12 or 48V and with A 10/100 Mbps ethernet connection. Marine instruments are connected through cables that adapt their signal to the OBSEA ethernet 10/100 interface.

The structure of the cables and connectors is a fundamental part of the project. After analyzing several options, the following elements were selected:

- *Submarine cable*: STC NL/LWS hybrid; copper conductor and 6 single mode optical fibers, 31.8 mm diameter, 2 steel wires layers for protection and traction, polyethylene isolation, aluminum sheet and white polyethylene outer jacket.
- *Trunk cable connector* (yellow cable): Hybrid flexible cable assembled by an oil filled high pressure hose with standard electrical and optical wires and terminated with a connector for the junction box and a penetrator for the termination box. the connector and penetrator are a GISMA series 40 size 4 with 6 optical single mode fibers and 2 electrical conductors. It is NOT wet mateable.
- *Instrument Connection cables*: Combined power and signal cable macartney type 4622 with  $2 \times 1\text{MM}^2$  power conductors and  $6 \times 0.22\text{m}^2$  twisted pairs constructed with a blue Polyurethane outer jacket.
- *Instrument connectors*: For the connection of oceanographic instruments to the observatory, the cylinder is fitted with 8 wet mateable connectors: GISMA series 10 size with  $7 \times \text{Ø} 1.5\text{mm}$  electrical pins.
- *Underwater termination box*: This box is used to adapt the rigid submarine cable with a flexible one that can be connected to the junction box. this box contains the

splices of the optical fibers and the electrical connection of the copper conductors

- *Beach manhole termination box*: Plastic splice box provided by Tyco telecom houses the connection between the submarine cable coming from the subsea station and the two terrestrial cables (optical and power) going to the shore station. it is the ground to sea interface.
- *Ground optical and electrical cables*: 1.5 km of standard outdoor cable with 8 optical fibers donated by telefonica and the same length of electrical cable of  $3 \times 10\text{mm}^2$  donated by prysmian and installed by abentel.

The entire system is powered from the shore station with a 3.6kw power supply delivering up to 320V and 11A of DC current, but there are plans to incorporate a 1000V power supply in the future which will deliver more power and allow longer cables. Internet connection is carried out in the land station through a router that implements access control and protection. On shore, there is a set of servers for oceanographic data management, SNMP (simple network management protocol) network elements supervision, control of the subsea station electronics, and storage of video images.

Some issues and challenges were tackled during the design process; one of them was the necessity to continuously power the equipment located some kilometres away from the shore station.

Therefore, a system was designed, capable of detecting the observatory’s power consumption variations and responding automatically without the intervention of an operator. Furthermore, since the observatory can accommodate more sensors in the future, a wide enough consumption margin was also implemented, to meet higher energy demands. Finally, to enable monitoring of the observatory’s operation, it was necessary to include periodic reports and incident signaling. at the shore station, to fulfill these requirements, the whole system is based on a programmable logic controller which analyses the observatory consumption using data obtained by current and voltage sensors and activates the necessary number of DC/DC switching converters. in standard conditions, the data acquisition system works with only four converter switches but up to twelve units have been installed to respond to possible consumption peaks or failures. the main elements of the system are the Omron CP1L M30DR-A programmable logic controller, the twelve converter switches that supply 27VDC each and the analogue module CPM1A-MAD01 that deals with the data acquired by the sensors. all of them are fed directly from the electrical grid. more details on reference [4].

## V. THE CABLE DEPLOYMENT AND THE OPERATIONS FOR THE OBSERVATORY INSTALLATION

The OBSEA was installed in May 2009 by the R/V *Sarmiento de Gamboa* at a depth of 20 m in the marine reserve area *colls Miralpeix*, 4 km offshore Vilanova i la Geltrú (Catalan Coast, western Mediterranean: Lat.  $41^{\circ}10'54.87''$  N - Long.  $1^{\circ}45'8.43''$ E). A deployment video can be accessed here [18].



FIGURE 6. Reel with the 4km cable and its support for deployment.

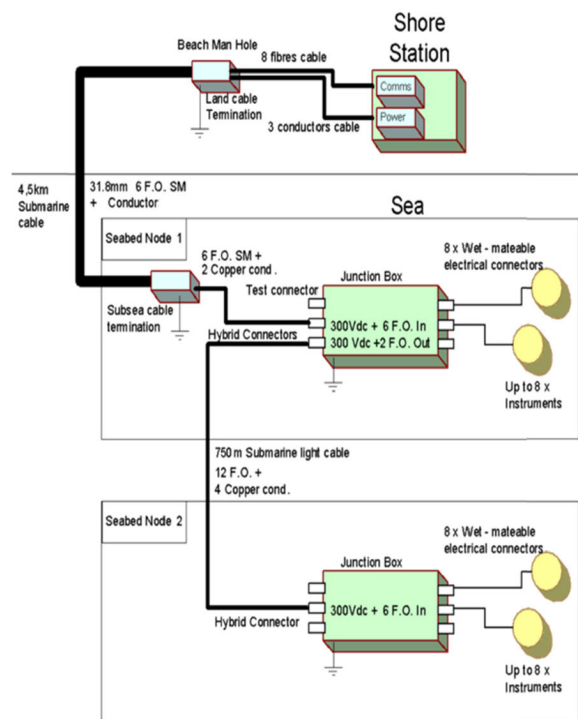

FIGURE 7. Connection diagram of the Shore Station and the Subsea Station.

A list of activities executed prior to the installation of the observatory are enumerated below:

1. Administrative authorizations (see previous section).
2. Beach manhole construction. pipeline from the water line to splicing chamber (Figure 7), and from this point to the shore station.
3. Design and implementation of the measurement and control software and IT infrastructure, installed in the shore station and in the underwater station observatory.
4. Construction of the underwater termination box.
5. Preparation of the submarine cable for its installation in a research vessel not intended for cable laying. The submarine cable donated by Telefonica was initially in an container and it had to be transferred to a reel (Figure 6). Design and construction of the reel support. transfer of cable from the container to the reel.
6. Planning the installation of the cable at sea. Considering the depth of the sea and the vessel characteristics that carried the cable reel, it was necessary to define the

**TABLE 3. OBSEA platform features.**

Infrastructure name	Expandable Seafloor Observatory (OBSEA)
Legal name of operating organization	Universitat Politècnica de Catalunya (UPC) - Remote Acquisition and Data Processing Systems (SARTI)
Coordinates (details) <i>Mediterranean - Balearic Sea – Catalan Sea - Central Coast – Garraf Coast.</i>	Fixed point observing system. <ol style="list-style-type: none"> <li>1. Surface buoy: OBSEA buoy; 41.1820°N 1.7527°E</li> <li>2. Coastal cabled system: Subsea station 1; 41.1819°N 1.7524°E</li> <li>3. Meteorological Station 41.2235°N 1.7363°E</li> </ol>
Description of the system	Fixed point observing system. <ol style="list-style-type: none"> <li>1. Surface buoy equipped with weather station (Temperature, pressure, wind, GPS, compass) and camera.</li> <li>2. Coastal cabled system equipped with CTD, Hydrophone, Camera, AWAC waves and current meter, Seismometer</li> <li>3. Meteorological Station equipped with Temperature, Humidity, Wind, Rain, Pressure, CO2.</li> </ol>
Web site address	<a href="http://www.obsea.es">http://www.obsea.es</a>
Additional services/data	Master CLK for IEEE std.1588 Precision Time protocol. Acts as a master clock on the network providing synchronization. It is connected to a GPS. Custom C instruments drivers for NMEA style frames generation via UDP or TCP on the Network. Different services in C, JAVA, LabVIEW, PYTHON, php and other for data processing and archiving. OGC SOS Provides interoperable access to data. Plug'n'play capabilities using OGC-PUCK and SensorML

closest point to the coast where the vessel could maneuver. This point defines the number of floats required for the maneuver of cable deployment at the sea, and the type of auxiliary boats needed (inflatable boat and tugboat).

7. Provision of equipment and materials necessary for the operations. A check list of all things necessary to carry out these operations at sea was done to avoid last minute fails.
8. Definition of the action protocol between the research vessel that contains the cable reel, the tugboat, the divers and the inflatable boat.

A relation of the main operations carried out on the cable laying day is listed below:

1. Preparation of the free end of the submarine cable with shackle swivel.
2. Divers hooked the rope onto the end of the cable from the tugboat and pulled it toward the beach, while in the vessel, floats were placed every 10 m along the cable. A different colored float was used to mark the end of the rope.
3. Used 2 inflatable boats to hold the cable route and align it with the beach while the tugboat pulled the cable to the beach.
4. Inserting of the cable into the conduit that is fastened on the beach. 1 km of cable was recovered on the beach with a bulldozer; the cable was then inserted through the pipe into the splicing camera (beach manhole).
5. Recovery and placement of floats on the beach once the cable is secure on the beach, and in the chamber. Divers checked to ensure there were no loops in the cable.
6. Cable pulled by the research vessel from the beach to the point where the seabed observatory will be located.
7. Beginning of the union of the terrestrial and submarine cable in the splicing chamber.
8. End of the cable run at the location to download the subsea station.

**TABLE 4. Some research activities that are carried out in the OBSEA observatory, and some published results by authors.**

RESEARCH ACTIVITY	PUBLICATION REFERENCE
Boron recovery from seawater	Chemical engineering journal (Demey et al. 2014)
Seawater acidification	Instrumentation viewpoint (Pelejero et al. 2014)
Sensors Interoperability	Journal Oceanic Engineering (DelRio et al. 2018)
Energy Harvesting	European Physical Journal (Viñolo et al. 2013)
Broadband Ocean Bottom Seismometer	Sensors (Mánuel et al. 2012)
Acoustic Telemetry for Underwater Sensors sensor networks	Journal of Oceanic Engineering (Pallares et al. 2016)
Behavior of the species	Meas. Science&Technology (Del Rio et al. 2011)
Video-imaging system	Hydrobiology (Guiomar et al.2015)
Metrology	Sensors (Del Rio et al.2013)
	Measurement (Garcia et al. 2018)

9. Lowering of the structure with a boat; divers helped during the maneuvers and ensured the structure was correctly placed.  
Measurement of the attenuation at the OBSEA shore station. Acceptance of the work, the installation, and junction.
10. To prevent friction of the cable in the area of the break-water, metallic protections were attached.

## VI. OBSEA RESEARCH ACTIVITIES

Despite periods of inactivity caused by faults in the connection cable (section VII), OBSEA has been fully operative since 2009; thanks to this, several research projects have been completed and others are now underway. The data acquired can be browsed via the observatory's webpage [19] as can be seen in Figure 8. In figure 9, ten years of raw data for water and air temperature (°C), pressure (atm) and depth (dbar) is shown. Under the concept of interoperability, and thanks to several grants from national and European projects, different lines of research have been developed, of which some examples are shown in Table 4.



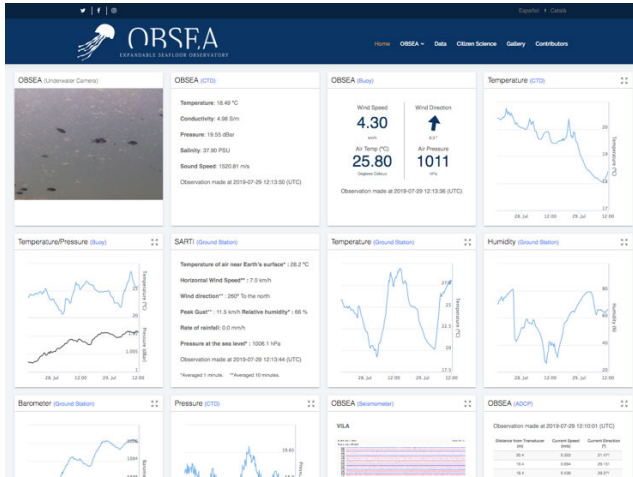

FIGURE 8. The platform web portal shows real time data and historic register data.

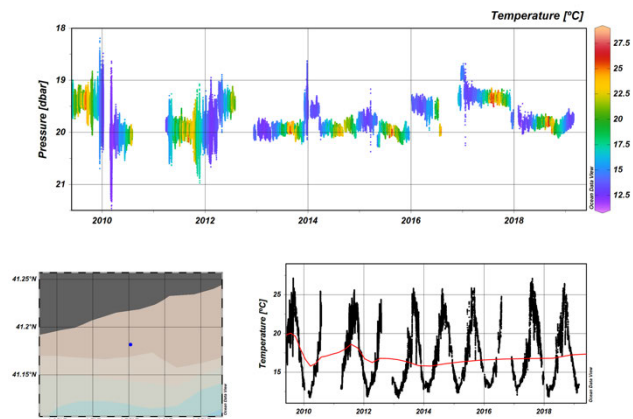

FIGURE 9. Ten years of raw data: Water temperature(°C), pressure (dBar) at OBSEA accessible in Pangaea [1], [2].

The existence of an observatory like OBSEA is useful for the implementation of interoperability processes at different levels, as scientific and technological profitability is improved drastically, while new investment added to the infrastructure and its maintenance are kept reasonably low compared to the total investment. It is a fact that interoperability of systems will result in a drastic reduction of maintenance of the observatory in the short term. Unlike terrestrial systems, seabed observatories are not easily accessible. For that reason, before installation, all equipment must be tested and integrated following defined standard procedures. The concept of quality management or mission assurance procedures are introduced and described in [20].

Currently, oceanographic instrumentation systems use proprietary communication protocols which differ from manufacturer to manufacturer according to the equipment or sensors. Since the complexity involved in an underwater observatory increases as the number of sensors or devices to monitor and control grows [21], it is necessary to apply interoperability approaches. Interoperability allows not only

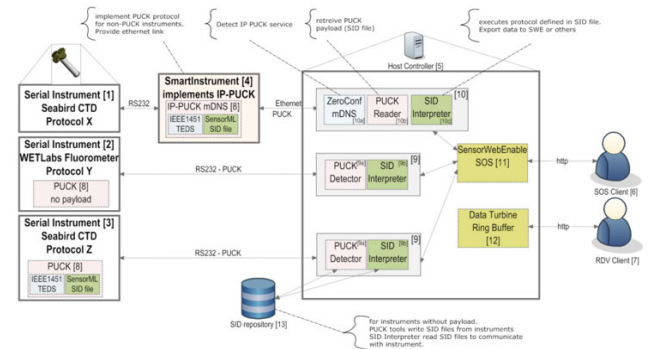

FIGURE 10. Early Sensor Web Enablement Architecture proposal using PUCK protocol and SID. Access to data generated by instruments (1, 2, 3), connected to a host controller (5) through standard Internet clients (6, 7) without any manual configuration steps at installation or run time. Instruments 2 and 3 are PUCK-enabled serial devices; the SID describing the instrument protocol and data formats is stored within the PUCK payload (8) of its corresponding instrument [22].

to seamlessly exchange equipment, but also the information generated by each of them can be understood by all subsequent units of data processing. It is worth noting the interoperability research done with the development of SensorML [7] and IEEE1451 [22]. The use of IEEE1451 standards was proposed throughout the process of data acquisition and processing from sensors connected to OBSEA, as well as utilization of the protocol OGC SWE PUCK [23]. OBSEA researchers, as part of the Smart Ocean Sensors Consortium [24], have participated in the drafting of different regulations. These provide a basis for data availability and to facilitate the automatic retrieval of the information. Through Internet technology, Smart Transducer Web Services (STWS) [25] provide access and information management.

Figure 10 shows an early use of the Sensor Web Enablement Architecture using the PUCK protocol and SID [23], that has been evolving with inputs from the community and the research done in within different European projects [7], [20], [26]. The use of schemes for sensor information metadata is especially important to facilitate interoperability when the information of different equipment and observatories must be integrated in the same system.

## VII. MAINTENANCE DIFFICULTIES

Since its installation, OBSEA began recording data from the sensors installed. Maintenance tasks involving a large vessel were planned from the beginning. The research group SARTI does not have its own vessels, but since the deployment with the R/V *Sarmiento de Gamboa* was a success, plans were made to avail of a trip from her home base in Vigo to Barcelona to perform these maintenance tasks. Bio-fouling effects were found significant after one year and the maintenance of the junction box was also deemed necessary.

Marine instrumentation has been evolving steadily and efficiently, from a technological point of view, with respect to energy consumption, data storage capacity or transmission, data quality and calibration protocols. The conjunction



**FIGURE 11.** A. OBSEA on board R/V Sarmiento de Gamboa. B. A close up view showing the dome and the camera.

between the increasing number of available *in situ* measurement techniques and the demand for offshore autonomous operations have made fouling, both biological and chemical/physical, one of the most pressing concerns for any long-term *in situ* ocean observatory. Awareness of the type of expected fouling, state of the art mitigation techniques and the propensity to varying degrees of fouling for instruments in different environments will influence the design. The degree of fouling will be different for fixed platforms, vertical profilers, and mobile platforms and also for surface versus bottom, and near coastal versus open ocean deployments.

Biofouling effects on marine instrumentation are numerous. These include hydrodynamic screening, reduction of thermal exchanges, modifications of interface properties, all crucial for any transducer, as well as additional corrosion or bio-degradation of the supports. Presently, only four bio-fouling protection systems for oceanographic sensors can be found in the market [27].

- Purely mechanical devices such as wipers or scrapers.
- “Uncontrolled” biocide generation system based on the copper corrosion mechanism or tributyltin (TBT) biocide leaching.
- “Controlled” biocide generation systems based on a localized seawater electro-chlorination system or an automatic acid dispensing device.
- Ultraviolet lighting systems

On August 3, 2010, on board the *Sarmiento de Gamboa*, different maintenance tasks were performed on the Observatory including the mechanical cleaning of the structure, and installation of sacrificial anodes (Figure 11). Although maintenance operations took only a few hours, once the observatory was placed back on the seabed and powered up, it stopped working due to a short circuit on the submarine cable. This was the most serious incident that the observatory has suffered since its installation in 2009.

The procedure followed to solve this problem is explained in detail:

On October 22<sup>nd</sup>, 2010, using a shallow draft boat from the port of Vilanova, the observatory was raised to the surface. Once on deck, the cable was tested. The voltage measured with a voltmeter was about 240 V when the power supplies at the shore station started up, but they could not maintain the charge and they stopped. To troubleshoot the problem,



**FIGURE 12.** Pictures shows the interior of the Underwater termination box with rust showing the water level.

the underwater termination box was investigated. This box is used to terminate the rigid submarine cable and connect it to a flexible one, which in turn is connected to the junction box in the observatory. The flexible cable was unplugged from the junction box and the system was re-powered, but the power supplies still could not sustain the load and stopped again. The problem was therefore either in the underwater cable or in the termination box. Since the system would not be operative for some time, a decision was made to remove the junction box, the video camera and the rest of equipment and to put a stopper in the trunk cable connector. The structure without junction box, sensors and camera was lowered again. In picture 12 it is possible to observe the level the water reached inside the termination box cylinder.

On the 25<sup>th</sup> and 26<sup>th</sup> October 2010 the junction box was pressurized in the hyperbaric chamber located in SARTI group headquarters in order to inspect the source of the leak. It was located in one of the lids.

Over the following months different tasks were performed at the SARTI-UPC laboratories, in order to produce a new operational junction box and its electronics, and a new connection hose between the junction box and the termination box. From that moment, the problem focused on the analysis of the underwater termination box, establishing four possible causes for the fault:

- a. Possible porosity of the hose that connects the underwater termination box with the junction box unit.
- b. Failure on the welding of the underwater termination box.
- c. Filtration in the cover of the underwater termination box.
- d. Filtration in the submarine cable.

These causes could not be investigated without prior recovery of the termination box from the sea. To narrow the problem down and exclude other possible effects, it was decided to measure the cable continuity throughout its length; the optical cable had been tested previously.

The terrestrial cable was thus disconnected from the submarine cable at the beach manhole, power was turned on and since there was no short circuit the conclusion was that the cable on dry land was fine. This test was needed due to the plagues of rodents that were found in the cable route while it was being paved and the cable piped. Electrical continuity measurements made on the subsea section from the beach



**FIGURE 13.** The cable before and after the repairs.

manhole were not reliable, and the question was whether the problem was in the submarine cable or in the termination box.

On 21<sup>st</sup> February 2011, a new line of action was proposed to continue troubleshooting the observatory. The underwater termination box was opened, and the interior was found to be dry. After wiping the inside with paper and alcohol, researchers continued cleaning the cable attempting to detect the fault and removed an outer layer of tape which protects the heat-shrinkable tube. The heat shrinkable tube seemed to be in good condition and did not show signs of leakage. Despite this, the short circuit persisted.

It was then decided to pull about 15 feet of cable on deck to check for potential troubles. A chunk of broken rope tied to the cable was discovered. When these were removed, the cable was found to be broken, showing the outer layer of the insulation, the aluminum screen and the inner layers of insulation, exposing the steel cables (Figure 13). This was the cause of the short circuit. Below is a list of the tasks performed in order to resolve the damage in the cable.

- Fill with Prysmian 16774 25 mm tape to complete the internal insulation.
- Connect the shields of aluminum with  $3 \times 1.5 \text{ mm}^2$  wires fastened with steel flanges and covered with electrical tape.
- Remove all dirt and grease from the cable sheath with sandpaper and then with alcohol.
- Cover the entire area with tape Prysmian 16980 50 mm taking special care to cover the metal flange bolts and protect them with electrical tape.
- Place heat shrink sleeve 60cm zipper Tyco Raychem CRSM 84/20 heated with the heat gun and torch gas from the center toward the edges until it was perfectly adapted to the cable.
- Mount the junction box. Due to environmental conditions and the fragility of the fibers, the fiber splice operation was very complex. (Figure 14).



**FIGURE 14.** Termination box and the optical fiber connection.

- Power connection and box put back to verify that the short circuit does not occur again. 0A was recorded at the Shore Station for the current through the cable.

The final conclusion of all maintenance tasks performed as a result of the incident was that, during maintenance operations on August 3<sup>rd</sup>, 2010 onboard R/V *Sarmiento de Gamboa*, at 10 m from the observatory, the submarine cable suffered a stress on the deck, which, once submerged in the water, caused a short circuit. The analysis of the cause of the problem made evident a series of good work practices some of which are described below.

For handling the junction box:

- Proceed to tighten the screws of the covers using a torque wrench.
- Test the correct behavior of the junction box in the hyperbaric chamber.
- Once tested, if the junction box is then opened at any time by the crew on the deck of the vessels, a perfect sealing of the equipment must always be ensured.

For a new junction box construction.

- Separation of electrical and optical connectors so they can be wet mateable.
- To have a test port that allows connections for powering and for data.
- The holding structure should be modular and the assembly / disassembly of elements underwater should be simple.
- Since hybrid connectors (power / fiber trunk cable connector) are very expensive and the power connector can only be dry handled, for observatories located at depths of 20/30m a connecting cable of about 80m between the junction box and the underwater termination box is recommended. That way the junction box can be recovered to the surface for maintenance without having to move around the observatory.
- All hardware that is mounted on the structure must be lubricated to avoid jamming and screws should be of the exact length to ensure against organisms adhering to them and blocking the threads.
- In sea operations, the size of the boat should be proportional to the size of the observatory.

The most serious incident that the observatory suffered since its installation in 2009 was the short circuit of the submarine cable. This incident, analyzed in detail in this paper, kept the observatory offline for seven months; only the observation

**TABLE 5. The most relevant repair and maintenance activities.**

Failure Event	Date	Maintenance Action	Date
Short circuit	03/08/2010	Damaged cable repair	21/02/2011
Some part of the terrestrial cable was stolen	26/12/2012	New terrestrial cable installation	01/04/2013
Fishing net hooked	16/11/2014	New Connectors/Equipment	16/04/2015
Rats damage terrestrial fiber cable	07/09/2015	Fusion of the new optical fibers	17/09/2015
Strong storm at sea. Some parts of the structure appear 150 km away	26/01/2017	New chains in the buoy and equipment change	01/02/2017
Boat crash on surface buoys	20/04/2017	New measurement equipment	01/06/2017

equipment powered by batteries and installed in the buoy, the water column and seabed was operational. But there have been other incidents that have shut down the observatory for long periods of time. In Table 5 relevant incidents suffered by the installation are shown; this table does not show the regular maintenance tasks that affect the operational status of instruments, such as installation, cleaning, calibration, installation of anodes, etc.

## VIII. CONCLUSION

Long-time series of environmental parameters are needed for the study of the effects of climate change on the marine environment. For this reason, networks of permanent cabled observation systems are being implemented in the ocean.

In this paper, as an example of such a system, the activities carried out at the OBSEA seabed observatory have been described, since its deployment ten years ago, as well as a balance between the monitoring success and maintenance drawbacks. The experience of a decade can be summarized, mainly, in the following contributions:

- Cabled observatory cost. The cost of these turnkey infrastructures, depending on the location, characteristics and requirements, is usually in the order of several million euros. this represents a sum that, in the short term, a group of university researchers does not have, nor can they obtain in project grants. OBSEA is a low-cost observatory: the total cost for the equipment and infrastructure was about 300 k€. All design, construction and maintenance were, and continue to be, carried out by members of the SARTI research group. the launch of this unique facility has been possible thanks to the leadership of the researchers who made the initial proposal and the active participation of SME companies. the design and construction of the OBSEA platform has been a long journey, which began with some small research project grants in 2005.

- EMSO member. Although it could be said that it is a homemade observatory, OBSEA is a member of the European Multidisciplinary Seafloor and water column

observatory (EMSO). The implementation of marine sensor networks at regional level has been considered within the esfri (European Strategy Forum for Research Infrastructures) roadmap as a European Infrastructure of great strategic interest.

- Shallow water observatory. OBSEA is a cabled seafloor observatory, located in a place of easy access and in shallow water (20m depth), that offers better weather and work conditions than other observatories located in Northern Europe. The OBSEA seabed observatory is connected to the coast by an energy and communications cable, that provide Power, Ethernet and serial communications, and synchronization over PTP IEEE Std 1588 (mandatory for the underwater seismometers without GPS access). A continuous real-time communication allows real-time monitoring along the full experiment. These conditions give OBSEA an ideal profile as a test site observatory to test equipment and to carry out trials of experiments that will be performed at a later stage in deep water, where serious effects on the equipment and observations could occur if faults were only discovered then and handled incorrectly.

- The fields of study rely on OBSEA'S connected sensors, and the location of the platform in the sea. the facility offers a wide range of possibilities. it can be used to identify geological hazards, the study of ocean circulation, variation in sea level and weather, the identification of species, the estimation of their biomasses and associated behavioral rhythms, which is growing in importance for fishery management and biodiversity estimation in continental margin areas and the deep-sea (a novel morphometry-based protocol for automated video-image analysis of data from the OBSEA camera [28]). The main advantage of having a cabled observatory is that it provides continuous energy and a broadband link to connected scientific instruments and therefore interacts in real time with them (for example, it allows the modification of sampling moments and rate, sensitivity, control energy, etc.), thus allowing observations to be made which would otherwise be impossible in autonomous (not-cabled) observatories. The research projects shown in table1 are initiatives in this direction and will enable the study of the complex, and still relatively unexplored, world of the processes occurring on the seabed which contain many of the scientific answers to the system dynamics we observe on the surface.

- Standard protocols and formats facilitate interoperability, maintenance and replacement of observatory sensors and maintain traceability of the data they generate [23]. A key idea of the obsea proposal is that the information about the sensor resides physically "inside" the sensor. This means sensor metadata is stored within the device itself, and marine platforms can interrogate the sensor to download this information to identify, configure, and operate the device. SARTI research group uses and is involved in the design of the OGC (open geospatial consortium) PUCK protocol as a standard way to access this metadata [29].

- Data from the marine environment are a valuable asset. The data received from the observatory is being stored for

future studies and transmitted in real time to the users involved in research projects related to sea observation and climate change. In order to provide free access to the data register information, OBSEA established links with eu data archives such as the european marine observation and data network [30], that facilitates coastal ocean monitoring in real time. the 10 years' long archived dataset is now publicly available in pangaea [1], [2].

In this paper, the advantages of a seabed observatory in the coastal ocean monitoring research have been shown; these observatories are really transforming ocean and earth sciences with the use of distributed submarine sensor networks wired to internet. As major drawbacks, apart from the high investment cost represented by the different equipment and devices, deployment operations (cable and subsea stations) and overall infrastructure development, the administrative difficulties related to consent for installation and occupation of the Public Domain, as well as potential conflicts of interest between scientific and fishing activities are highlighted. To increase the spatial representativeness of fixed observatories in the immediate future, it is proposed to complement the (expanded) observatories with the use of flexible and adaptive monitoring platforms, vehicles (Autonomous Underwater Vehicles AUVs) AND underwater robots (crawlers), which work in cooperation both spatially (various nearby areas) and temporally (coordinated with each other) [31]. This multi-parameter coordinated monitoring is a challenge that must be tackled in order to implement standardized protocols in data acquisition and automation in biological and ambient indicators monitoring.

## ACKNOWLEDGMENT

The authors would like to thank A. Mànuel, B. Mànuel, and Dr. R. Chumbinho for their support during the proofreading. This work used the EGI infrastructure with the dedicated support of INFN-CATANIA-STACK. All Authors are members of the SARTI Research Group at Universitat Politècnica de Catalunya. All have contributed, in the last 10 years, to the SW and HW design, construction, deployment, maintenance and exploitation of the Observatory.

## REFERENCES

- [1] J. D. Río. (2019). *Obsea CTD 2009-2019*. Accessed: Jul. 1, 2019. [Online]. Available: <https://doi.pangaea.de/10.1594/PANGAEA.902215>
- [2] J. D. Río. (2019). *Obsea Meteo 2010-2019*. Accessed: Jul. 1, 2019. [Online]. Available: <https://doi.pangaea.de/10.1594/PANGAEA.903050>
- [3] P. Favali and L. Beranzoli, "Seafloor observatory science: A review," *Ann. Geophys.*, vol. 49, nos. 2–3, pp. 515–567, 2006.
- [4] J. Aguzzi, A. Mànuel, F. Condal, J. Guillén, M. Nogueras, J. D. Río, C. Costa, P. Menesatti, P. Puig, F. Sardà, D. Toma, and A. Palanques, "The new seafloor observatory (OBSEA) for remote and long-term coastal ecosystem monitoring," *Sensors*, vol. 11, no. 6, pp. 5850–5872, May 2011.
- [5] J. Aguzzi, V. Sbragaglia, S. Tecchio, J. Navarro, and J. B. Company, "Rhythmic behaviour of marine benthopelagic species and the synchronous dynamics of benthic communities," *Deep Sea Res. I, Oceanograph. Res. Papers*, vol. 95, pp. 1–11, Jan. 2015.
- [6] V. Sbragaglia, J. D. Nuñez, D. Dominoni, S. Coco, E. Fanelli, E. Azzurro, S. Marini, M. Nogueras, M. Ponti, J. D. R. Fernandez, and J. Aguzzi, "Annual rhythms of temporal niche partitioning in the Sparidae family are correlated to different environmental variables," *Sci. Rep.*, vol. 9, no. 1, Dec. 2019, Art. no. 1708.
- [7] J. D. Río, D. M. Toma, E. Martinez, S. Jirka, and T. C. O'Reilly, "From sensor to user-interopability of sensors and data systems. Sensor interoperability protocol for seamless cross-platform sensor integration," in *Challenges and Innovations in Ocean In Situ Sensors: Measuring Inner Ocean Processes and Health in the Digital Age*. Amsterdam, The Netherlands: Elsevier, 2018, pp. 289–303.
- [8] (2019). *EMSO-Obsea*. Accessed: Jul. 1, 2019. [Online]. Available: <http://emso.eu/observatories-node/obsea/>
- [9] *Illuminating the Hidden Planet. The Future of Seafloor Observatory Science*. Washington, DC, USA: National Academy Press, 2000.
- [10] C. Millot, "Deep physical oceanography experimentation and benefits from bottom observatories," in *Developments in Marine Technology*. 2002, pp. 19–26.
- [11] H. Thiel, K.-O. Kirstein, C. Luth, U. Luth, G. Luther, L.-A. Meyer-Reil, O. Pfannkuche, and M. Weydert, "Scientific requirements for an abyssal benthic laboratory," *J. Marine Syst.*, vol. 4, no. 6, pp. 421–439, Mar. 1994.
- [12] University of Victoria's Ocean Networks Canada. *ONC*. Accessed: Jul. 1, 2019. [Online]. Available: <http://www.oceannetworks.ca/>
- [13] JAMSTEC. (2019). *Research and Development Center for Earthquake and Tsunami*. Accessed: Jul. 1, 2019. [Online]. Available: [http://www.jamstec.go.jp/ceat/donet\\_data/](http://www.jamstec.go.jp/ceat/donet_data/)
- [14] (2019). *Aloha*. Accessed: Jul. 1, 2019. [Online]. Available: <http://aco-sds.soest.hawaii.edu/>
- [15] (2019). *EUROSITES Final Report 2019*. Accessed: Jul. 1, 2019. [Online]. Available: [https://cordis.europa.eu/result/rcn/224989\\_en.html](https://cordis.europa.eu/result/rcn/224989_en.html)
- [16] (2019). *Colls Miralpeis*. Accessed: Jul. 1, 2019. [Online]. Available: <http://www.collsmiralpeix.cat/>
- [17] D. M. Toma, A. Manuel-Lazaro, M. Nogueras, and J. D. Río, "Study on heat dissipation and cooling optimization of the junction box of OBSEA seafloor observatory," *IEEE/ASME Trans. Mechatronics*, vol. 20, no. 3, pp. 1301–1309, Jun. 2015.
- [18] Manuel-Lázaro and J. D. R. Fernandez. (2009). *Obsea Installation*. [Online]. Available: <http://www.youtube.com/watch?v=pxAEGDvFWB8>
- [19] UPC. (2019). *Obsea Web Page*. Accessed: Jul. 1, 2019. [Online]. Available: <https://obsea.es/>
- [20] E. Delory, D. M. Toma, J. D. Río, P. Cervantes, P. Ruiz, and S. Memè, "Ocean in-situ sensors: Cross-cutting innovations. A new generation of interoperable oceanic passive acoustic sensors with embedded processing," in *Challenges and Innovations in Ocean In Situ Sensors: Measuring Inner Ocean Processes and Health in the Digital Age*. Amsterdam, The Netherlands: Elsevier, 2018, pp. 117–134.
- [21] L. Bermudez, J. Graybeal, A. W. Isenor, R. Lowry, and D. Wright, "Construction of marine vocabularies in the marine metadata interoperability project," in *Proc. OCEANS*, Jul. 2006, pp. 2578–2585.
- [22] K. B. Lee and E. Y. Song, "Object-oriented application framework for IEEE 1451.1 standard," *IEEE Trans. Instrum. Meas.*, vol. 54, no. 4, pp. 1527–1533, Aug. 2005.
- [23] J. D. Río, "Standards-based plug & work for instruments in ocean observing systems," *IEEE J. Ocean. Eng.*, vol. 39, no. 3, pp. 430–443, Dec. 2014.
- [24] (2019). *Smart Ocean Sensors Consortium*. Accessed: Jul. 1, 2019. [Online]. Available: <https://sites.google.com/site/sosocsite/>
- [25] J. D. Río, D. M. Toma, E. Martinez, T. C. O'Reilly, E. Delory, J. S. Pearlman, C. Waldmann, and S. Jirka, "A sensor Web architecture for integrating smart oceanographic sensors into the semantic sensor Web," *IEEE J. Ocean. Eng.*, vol. 43, no. 4, pp. 830–842, Oct. 2018.
- [26] E. Martinez, D. M. Toma, J. D. Río, and S. Jirka, "Remote configuration service for marine observation platforms through sensor Web Enablement components," in *Proc. OCEANS*, Jun. 2017, pp. 1–5.
- [27] M. Lehaitre and C. Compère, "Biofouling and underwater measurements," in *Real-Time Coastal Observing Systems for Marine Ecosystem Dynamics and Harmful Algal Blooms: Theory, Instrumentation and Modelling, Oceanography*, M. Babin, C. S. Roesler, and J. J. Cullen, Eds. Paris, France: UNESCO Publishing, 2008, pp. 463–493.
- [28] F. Condal et al., "Seasonal rhythm in a Mediterranean coastal fish community as monitored by a cabled observatory," *Mar. Biol.*, vol. 159, no. 12, 2012.
- [29] T. O'Reilly, D. M. Toma, J. Del-Rio-Fernandez, and K. Headley. (2012). *OGC PUCK Protocol Standard*. [Online]. Available: <http://www.opengeospatial.org/standards/puck>
- [30] Emodnet. (2019). *Emodnet*. Accessed: Jul. 1, 2019. [Online]. Available: <http://emodnet-physics.eu/Portal>
- [31] J. Aguzzi et al., "Coastal observatories for monitoring of fish behaviour and their responses to environmental changes," *Rev. Fish Biol. Fisheries*, vol. 25, no. 3, pp. 463–483, 2015.



**JOAQUIN DEL-RIO** (Member, IEEE) was born in Catalonia, Spain, in 1976. He received the B.Sc. and M.Sc. degrees in telecommunication engineering and electronic engineering from the Universitat Politècnica de Catalunya (UPC), Barcelona, Spain, in 1999 and 2002, respectively. Since 2001, he has been an Assistant Professor with the Electronic Engineering, Department, UPC. He is currently a member of the Remote Acquisition Systems and Data Processing (SARTI), focusing his research on electronic instrumentation, interoperability in marine sensor networks, and wireless sensor networks.



**IKRAM BGHIEL** received the degree in computer engineering from the Polytechnic University of Catalonia, in 2014. Since 2010, she has been with the Remote Acquisition Systems and Data Processing (SARTI), Polytechnic University of Catalonia. The main areas of her work are the data management, ocean observatory cyber infrastructure, and web services.



**MARC NOGUERAS** was born in Catalonia, Spain, in 1976. He received the B.S. and M.S. degrees in telecommunication engineering from the Universitat Politècnica de Catalunya (UPC), Barcelona, Spain, in 1999 and 2003, respectively, and the master's degree in electronic engineering from the Universitat Rovira i Virgili (URV), Tarragona, Spain, in 2012. For four years, he was with Global Networking Engineering (GNE), developing projects and installing optical communications



**MARC MARTINEZ** received the degree in computer engineering from the Polytechnic University of Catalonia, in 2017, and the master's degree in data sciences from the Open University of Catalonia, in 2020. His current research interest is in acquiring knowledge by developing data architectures that support machine learning applications.

systems for electrical utilities. Since 2006, he has been an Applications Engineer with the Remote Acquisition Systems and Data Processing (SARTI) coordinating and developing the project for the construction of the OBSEA, a wired underwater observatory.



**DANIEL MIHAI TOMA** received the M.Sc. degree in electrical engineering from the Gheorghe Asachi Technical University, Iasi, Romania, in 2008, and the Ph.D. degree in the electronic engineering from the Universitat Politècnica de Catalunya (UPC), Barcelona, Spain, in 2012. He is currently a member of the Remote Acquisition Systems and Data processing (SARTI), Electronic Engineering Department, UPC. His current research interests include marine instrumentation,



**JAVIER CADENA** received the B.S. degree in telecommunication engineering from the Universitat Politècnica de Catalunya (UPC), Barcelona, Spain, in 1999. He has been the Chief Technology, Security and Financial Officer with the SARTI, since 1999. He has been involved in different national and international research projects as well as in projects for the industry.

ocean observing systems, wireless ad hoc networks, interoperability in sensor networks, synchronization and scheduling in sensor networks, energy harvesting techniques, and passive acoustics.



**ENOC MARTÍNEZ** received the M.S. degree in electronic engineering from the Universitat Politècnica de Catalunya (UPC). He is currently pursuing the Ph.D. degree with the SARTI-MAR Research Group, Electronics Department, UPC. His fields of interest include interoperability, sensor web standards, underwater noise measurements, and underwater acquisition systems.



**ALBERT GARCIA-BENADI** received the bachelor's degree in physical sciences from the University of Barcelona, in 2000. He is currently the Technical and Quality Manager of the UPC Metrology and Calibration Laboratory accredited under ISO 17025 with accreditation number 152 / LC10.110. The current research interests are in acoustics measurement systems, atmospheric parametrization, meteorology radars, and oceanic environment.



**CAROLA ARTERO-DELGADO** received the degree in industrial electronics and automation from UPC. Since 2006, she has been with the SARTI, UPC. Her field of expertise is the development of automatic measurement systems for ocean environments. Her current interests include electronic instrumentation, sensor networks, monitoring solutions, and scheduling.



**DAVID SARRIA** is currently pursuing the Ph.D. degree in electronic engineering with the Universitat Politècnica de Catalunya (UPC). Since 2005, he has been a member of the Remote Acquisition Systems and Data processing (SARTI). Since then, his research activities focus on low power instrumentation and acquisition systems for marine technology. His main line of research is the study and applicability of new techniques for monitoring marine species, including optical, radiofrequency, and acoustic technologies.



**JACOPO AGUZZI** has an expertise of highly interdisciplinary ecological and technological content (132 SCI articles, H-factor of 28). He was the Scientific Advisor of the Ocean Network Canada (ONC Science Theme Leader), being currently an Active Member of the Working Group on Nephrops Surveys (WGNEPS-ICES) and of the International Network for Scientific Investigation of DEEP-Sea ecosystems Community (InDEEP).



**SPARTACUS GOMARIZ** received the M.Sc. and Ph.D. degrees in telecommunication engineering from the Universitat Politècnica de Catalunya (UPC), Barcelona, Spain. He is currently an Associate Professor with the Department of Electronic Engineering, UPC, and a member of the Remote Acquisition Systems and Data Processing (SARTI). His research interests include linear and nonlinear control theory, gain scheduled control, fuzzy control, design of navigation, guidance, and control systems for underwater vehicles. He is a member of IEEE Oceanic Engineering Society and Spanish Committee of Automation (CEA) of International Federation of Automatic Control (IFAC).



**IVAN MASMITJA** received the M.S. degree in electronic engineering from UPC, where he is currently pursuing the Ph.D. degree in underwater target tracking using acoustic-range only methods and moving platforms. His field of expertise is underwater technology, involved in both underwater cabled observatories and autonomous vehicles. He has been working at SARTI-MAR research group, UPC, since 2011, participating in different national and international projects, and collaborating

with different institutions such as the Monterey Bay Aquarium Research Institute (MBARI), the Institut Supérieur de l'Électronique et du Numérique (ISEN), and the Institute of Marine Sciences (ICM-CSIC).



**MATIAS CARANDELL** was born in Barcelona, Spain, in 1991. He received the B.S. and M.S. degrees in industrial engineering from the Technical University of Catalonia (UPC), with the specialty of electrical engineering, in 2015. After, he spent one year at Universidad Técnica Federica Santa Maria (UTFSM), from Chile, working with solar power converters. He is currently pursuing the Ph.D. degree in electronic engineering with the Remote Acquisition Systems and Data Processing

(SARTI), UPC. His current research interests include energy harvesting in marine environment, energy conditioning systems for autonomous sensors, and autonomy concerning Lagrangian Drifter electronics.



**PEP SANTAMARIA** received the master's degree in telecommunication engineering from the Technical University of Catalonia, in 1980. For 30 years, he was the Operation and Maintenance Manager with Telefonía. Since 2009, he has been the technological Advisor of the Remote Acquisition Systems and Data Processing (SARTI), focusing his research on quality management aspects related telematics and telecommunication systems applied to oceanic environment.



**JOAQUIM OLIVE** received the Ph.D. degree in chemistry from the Universitat Autònoma de Barcelona (UAB), in 1990. Since 1979, he has been a College Professor with the Department of Chemical Engineering, Universitat Politècnica de Catalunya-BarcelonaTech (UPC). He has also been the Director of the Remote Acquisition Systems and Data Processing (SARTI), UPC, since 2014. His current research interest is in chemometrics applications to the environment.



**ANTONI MÀNUEL LÀZARO** received the Ph.D. degree in telecommunication engineering from the Technical University of Catalonia, in 1996. Since 1988, he has been an Associate Professor with the Department of Electronic Engineering, Catalonia Technical University. He is currently the Director of the Remote Acquisition Systems and Data (SARTI).

...