

Received December 1, 2019, accepted December 19, 2019, date of publication January 1, 2020, date of current version January 22, 2020.

Digital Object Identifier 10.1109/ACCESS.2019.2963514

Beam Management in Millimeter-Wave Communications for 5G and Beyond

YU-NGOK RUYUE LI¹, BO GAO¹, XIAODAN ZHANG²,
AND KAIBIN HUANG³, (Senior Member, IEEE)

¹ZTE Corporation, Shenzhen 518000, China

²Shenzhen Institute of Information Technology, Shenzhen 518029, China

³Department of Electrical and Electronic Engineering, The University of Hong Kong, Hong Kong

Corresponding author: Xiaodan Zhang (zhangxd@szit.edu.cn)

ABSTRACT Massive MIMO is one of the promising techniques to improve spectral efficiency and network performance for reaching its targeted multi-gigabit throughput in 5G systems. For 5G New Radio (NR) systems, one of the key differences compared to 4G systems is the utilization of high frequency millimeter wave (mmWave) bands in addition to sub-6GHz bands. To keep the complexity and implementation cost low, hybrid analog-digital beam-forming with large-scale antenna array has become a common design approach to address the issue of higher propagation loss as well as to improve spectral efficiency in mmWave communication in 5G NR. The 5G NR standard is designed to adapt to different beam-forming architecture and deployment scenarios. This paper provides the overview on beam management procedure according to the current 5G standardization progress. We discuss some major challenges of millimeter-wave communications encountered in the current 5G NR standard and present some expected enhancements considered for the future beyond-5G standard.

INDEX TERMS 5G NR systems, beam management, physical layer, beyond 5G, hybrid beamforming, AI based beam management.

I. INTRODUCTION

The Third Generation Partnership Project (3GPP) has recently finished the standardization process of Release 15 of New Radio (NR) access technology which is the first version of the 5th Generation wireless system [1]. Meanwhile, the standardization process of next 5G release i.e. Release 16 is still on-going and will be expected to finish in 2020. For 5G systems, one of the key differences compared to 4G LTE is utilization of high frequency mmWave bands in addition to lower frequency bands for different targeted network deployment scenarios [2], [3]. The new Radio Access Technology (RAT) considers frequency ranges up to 100 GHz with system bandwidth larger than 100MHz or even reaching up to 1GHz [2]. For mmWave communication above 6GHz, it suffers from significant path loss and penetration loss [3]. One solution to solve this problem is to deploy large-scale antenna array to achieve high beam-forming gain to compensate the loss. It is a practical solution in high frequency

system due to smaller wavelength of high-frequency signal. For around 70 GHz, up to 1024 transmit (Tx) antenna elements are considered in the 5G NR study [1]. When antenna scale is so large, fully exploiting multiple-input multiple-output (MIMO) gain by pure digital beam-forming in baseband is not realistic due to the problems on hardware cost, power consumption and standardization complexity since it requires dedicated RF chain for each baseband antenna port [4]. Therefore, multi-antenna schemes considering hybrid analog-digital beam-forming, as shown in Figure 1, is supported in NR to reduce the cost and complexity of 5G equipment.

With hybrid beam-forming, it reduces the number of RF chains, also known as transmit-receive unit (TXRU) [5] and hence TXRU to antenna element mapping no longer to be one to one mapping. Hybrid beam-forming schemes for different TXRU virtualization structures have been studied recently with consideration of using phase shifters. TXRU virtualization can be categorized into full connection structure and subarray structure [6]–[9]. The full connection structure maps each TXRU to all antenna elements, while the subarray

The associate editor coordinating the review of this manuscript and approving it for publication was Lin Bai¹.

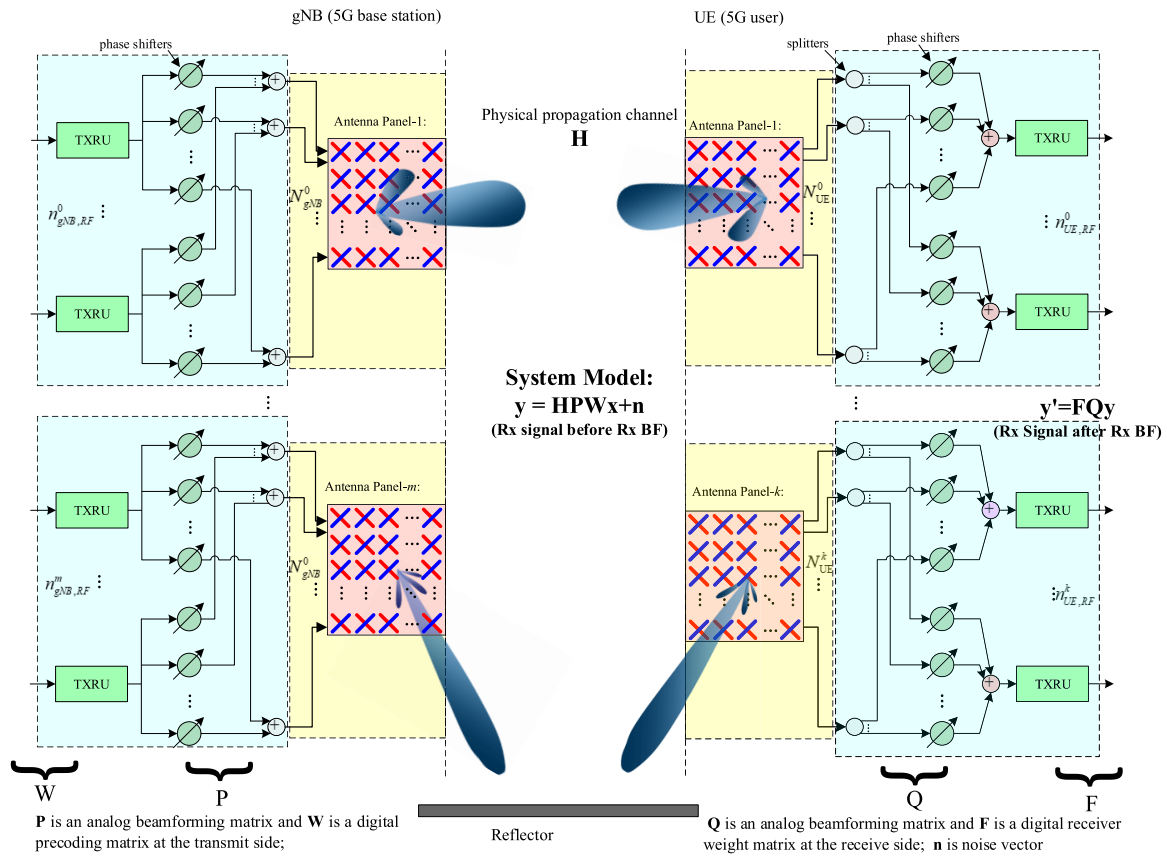

FIGURE 1. Hybrid beam-forming system in 5G.

structure maps each TXRU only to the antenna elements belonging to the same subarray by dividing antenna elements into multiple subarrays.

With massive number of antennas in 5G, multiuser (MU) MIMO can be effectively used to multiplex users in spatial domain by steering narrow beams towards users more precisely. In addition, beam-forming can be done in both azimuth and elevation domain with two-dimensional antenna array. This spatially separates more users in vertical direction as well as horizontal direction. In practice [10], MU-MIMO has been proven to work well with massive MIMO in 5G networks. To implement MIMO operation, acquiring accurate channel state information (CSI) at transmitter side is crucial especially for MU-MIMO. In LTE, there are two types of CSI acquisition schemes supported to obtain CSI at the base station: for frequency division duplex (FDD) operation, codebook-based feedback is used, while for the time division duplex (TDD) operation, reciprocity-based sounding is used [11]. With larger number of antennas introduced, the dimension of codebook increases accordingly. Therefore, it becomes more difficult to design optimal codebooks. Meanwhile, the overhead of downlink pilot used for CSI measurement (aka CSI-RS, CSI Reference Signal) and feedback overhead from User Equipment (UE) become too large. In addition, support multi-user using mmWave spatial division multiple access has certain constraints based on

number of RF chains and user grouping criteria in practical use cases [12]. Considering the above aspects, MIMO framework which can be scalable and adaptable to different MIMO scenarios has been standardized.

As 5G mobile communication using millimeter wave has become a hot topic, there is a good amount of previous work on beam management for millimeter wave considering mobile environment. In [13], [14], studied and proposed beam tracking algorithm in mobile environment by using extended Kalman filter to improve beam alignment accuracy. Some previous work considered location aided beam management considering mobility. Evaluation in [15] showed the benefits of location information for channel estimation and beam alignment. In [16], [17], inverse fingerprinting has been proposed to identify the beam pair links by machine learning based on the location information of base station and mobile user and past beam measurement. In [17], further improvement is done by online training. With these advanced beam management techniques in mind, the goal of this article is to provide the overview of standardization support on beam management for mmWave communication in the current 5G standards and the future beyond 5G standards. Some recent papers [18]–[20] have been published to provide overview of beam management for 5G millimeter wave in 5G NR standard. The overview paper [18] provides good high-level overview on CSI acquisition and beam management in

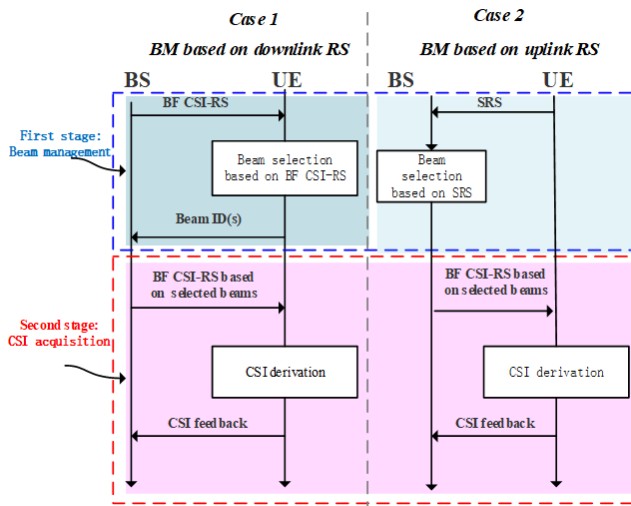

FIGURE 2. Two stage CSI framework.

Release 15 of 5G NR. Some papers [19], [20] focus more on the comparison of beam management operations for 5G NR-only standalone mode and 5G NR non-standalone mode together with 4G LTE carrier in initial access aspects. However, some of the details for each step of beam management in connected mode after initial access are missing in these papers. Moreover, there is not much discussion on beam management for more recent release e.g. Release 16 and future releases e.g. Release 17.

In this article, we provide overview of beam management schemes in the aspects of 5G standardization for the recent releases including Rel-15 and Rel-16 and the future releases of 3GPP NR standard. The rest of this paper is organized as follows: In Section II, we present an overview of MIMO standardized framework which consists of beam management stage and CSI acquisition stage. In Section III, we discuss some details of beam management procedure considering multi-panel operation. Evaluation results on group based reporting are shown. In Section IV, major challenges and future trends on beam management enhancements for beyond 5G in future NR standard releases are discussed. Conclusions are drawn in Section V.

II. STANDARDIZED 5G MIMO FRAMEWORK FOR MILLIMETER WAVE

To obtain channel state information (CSI), the standardized 5G MIMO CSI framework can be divided into two stages [18]. As shown in Figure 2, the first stage is beam management stage which is followed by CSI acquisition in the second stage. For hybrid beam-forming based mmWave systems, the beam management stage is often considered as the procedure of analog beam selection. Beam selection can be done based on measurement of reference signals (RS) where beamforming weights are applied across antenna elements for generating the RS so that the RS is transmitted in specific beam direction. The measurement can be based on downlink CSI-RS transmitted by a base station in Case 1 or

based on uplink Sounding Reference Signal (SRS) transmitted by a UE in Case 2. For both cases, the number of RS resources depends on the number of analog beams for selection. While the details of beam management procedure are described in Section III, beam selection process is described in high-level based on Case 1 and Case 2 as follows:

- **Case 1 BM based on CSI-RS** [18]–[21]: A pool of downlink CSI-RS resources is transmitted by base station (BS) corresponding to different analog beams. Beam selection is done at UE side after measurement. Beam ID is reported from UE to inform BS the beam selection. Beam ID refers to the index of selected CSI-RS resource which is virtualized by the selected analog beam. Along with the beam ID, beam quality measurement metric, e.g. Reference Signals Received Power (RSRP) [22], corresponding to the selected analog beam is calculated and fed back to the BS.
- **Case 2 BM based on SRS** [17], [20], [23]: A pool of uplink SRS resources are transmitted by UE corresponding to different analog beams. Beam selection is done at BS side after measurement. Beam measurement results from uplink SRS can be applied to beam selection for downlink analog beams based on channel reciprocity in spatial domain, where the angle of arrival at receiver becomes the angle of departure at transmitter and vice versa [17]. In this case, the selected beam refers to the receive beamforming weights used to receive SRS with the maximum received power.

Given that BS has obtained the information of selected analog beams in the first stage, the second stage of CSI acquisition is common to case 1 and case 2. In the second stage, selected analog beams are applied to downlink CSI-RS. Each of the CSI-RS ports is a digital port mapped to each of the TXRUs connected to a set of antenna elements by analog phase shifters based on the selected analog beam. It is known as beam-formed (BF) CSI-RS since analog beam-forming is performed on the CSI-RS ports. Based on the measurement on this BF CSI-RS, a UE derives a quantized CSI [18] in terms of rank indicator (RI), precoding matrix index (PMI), and channel quality indicator (CQI), which represents spatial channel multiplexing order, channel directional properties and channel quality respectively. The precoding matrix index points to a two-dimensional discrete Fourier Transform (2D-DFT) precoder in the standardized codebook [18], [24]. The selected 2D-DFT precoder can be used by the base station for digital precoding. Like LTE [25], the 2D-DFT codebook is targeted for 2D structural antenna array which steers the beam on both vertical and horizontal direction for 3D beamforming. After these two stages, the BS can obtain the full CSI which includes the information of selected analog beam and digital precoder for hybrid beam-forming.

III. BEAM MANAGEMENT PROCEDURE

As introduced in previous sections, due to the hybrid beam-forming structure of mmWave systems in 5G, one of the fundamental features is beam management process.

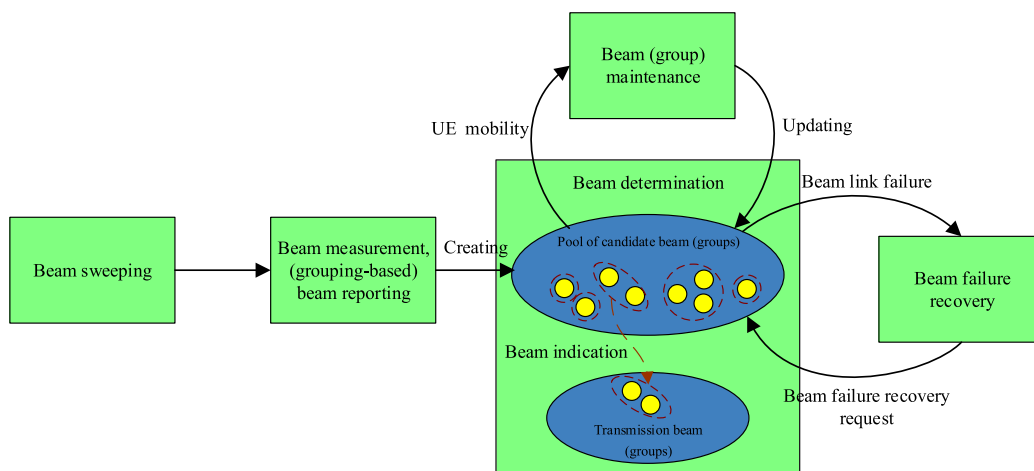

FIGURE 3. Beam management procedures.

In Section II, two simple approaches of beam selection process are described. Due to fast changing environment in reality including mobility, blockage [26] and UE rotation [27], beam management process involves more procedures in practice. In this section, we present and discuss about the related procedures under standardized MIMO framework. Beam management is defined as a set of Layer 1 [24] (i.e., physical layer)/Layer 2 [28] (i.e., medium access control) procedures to acquire and maintain a set of beam pair links i.e. a beam used at transmit-receive point(s) (TRP(s)) for BS side paired with a beam used at UE. The beam pair links can be used for downlink (DL) and uplink (UL) transmission/reception. The beam management procedures include at least the following six aspects. Some of the aspects are defined in the technical report during the study phase of 5G standardization [1].

- **Beam sweeping:** operation of covering a spatial area, with beams transmitted and/or received during a time interval in a predetermined way.
- **Beam measurement:** for TRP(s) or UE to measure characteristics of received beamformed (BF) signals
- **Beam reporting:** for UE to report information of BF signal(s) based on beam measurement
- **Beam determination:** for TRP(s) or UE to select of its own Tx/Rx beam(s).
- **Beam maintenance:** for TRP(s) or UE to maintain the candidate beams by beam tracking or refinement to adapt to the channel changes due to UE movement or blockage.
- **Beam recovery:** for UE to identify new candidate beam(s) after detecting beam failure and subsequently inform TRP of beam recovery request with information of indicating the new candidate beam(s)

Beam management can be done in both of UL and DL directions. When good channel reciprocity is available (e.g. in time division duplex (TDD) systems), beam management of one direction can be based on another direction, e.g. UL beam management can perform well based on the results of DL beam management. In legacy 4G systems, channel

reciprocity was discussed mainly based on non-precoded channel. In NR, a new terminology - beam correspondence is introduced in 3GPP for utilizing uplink-downlink reciprocity of beamformed channel: UL Tx/Rx beam(s) can be determined based on beam measurement of DL BF RS, and vice versa.

The standardized beam management framework can be used to support group based beam management. The concept of group based beam management is to manage beams in group basis instead of beam-by-beam basis, considering that beams sharing similar channel properties can be put into the same beam group. The beam management procedure including beam sweeping, beam measurement, (grouping-based) beam reporting, beam determination, beam (group) maintenance and beam failure recovery is shown in Figure 3. Details of each step are described in Parts A-F below.

A. BEAM SWEEPING

Three procedures of beam management can be used with beam sweeping on TRP and/or UE side as described below:

- Procedure 1 (P1): TRP beam sweeping and UE beam sweeping.
- Procedure 2 (P2): TRP beam sweeping only.
- Procedure 3 (P3): UE beam sweeping only.

The examples for P1, P2 and P3 procedures can be found in Figure 4.

To perform sweeping over multiple Tx beams, each Tx beam can be transmitted on an RS resource for beam management. To perform sweeping over multiple Rx beams, each Tx beam can be transmitted repeatedly multiple times in the same RS resource set so that receive side can sweep its Rx beams in multiple transmission instants. For downlink beam management, it assumes TRP has a set of N Tx beams and UE has a set of M Rx beams for beam sweeping in P1. Each of the N Tx beams is transmitted M times from the TRP side so that the UE can be received using M multiple beams per Tx beam. Therefore, $N \times M$ BF CSI-RS transmission instants are required for P1. For P2, N BF CSI-RS transmission

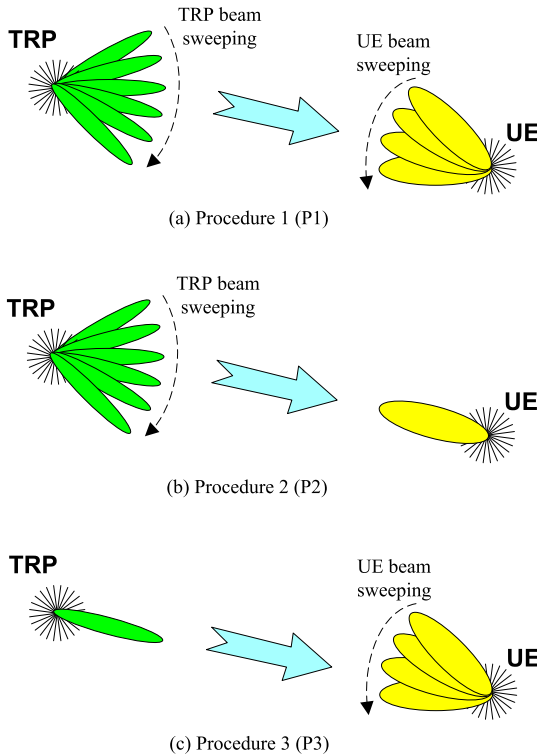

FIGURE 4. Procedures of beam sweeping: (a) P-1, (b) P-2 and (c) P-3.

instants are required since the UE receives a set of N Tx beams with the same Rx beam. For P3, it requires M BF CSI-RS transmission instants with the same Tx beam for the UE to sweep M Rx beams. For uplink beam management, the process can be the same except that the transmit side and receive side is switched between TRP and UE.

B. BEAM MEASUREMENT

UE/TRP performs beam measurement by measuring beam sweeping based RS, i.e. CSI-RS, for downlink and SRS for uplink. For downlink, a UE measures the received power of each BF RS so that the beam quality can be derived from beam measurement. Based on the measurement, beam grouping can be performed by the UE. To be more specific, each UE groups downlink Tx beams into the same beam group, according to spatial channel properties (including angle of arrival and spatial correlation, etc) observed by the UE. Since less number of antenna elements is usually equipped at UEs compared to TRPs, the beamwidth of UE Tx/Rx beams is often wider. It is reasonable to assume that multiple TRP Tx beams correspond to the same Rx beam at UE. Therefore, instead of one-to-one beam pairing, these multiple Tx-Rx beam pairs are often considered as multiple-to-one beam grouping. Beam grouping also lets UE identify multiple clusters observed by the UE.

C. BEAM REPORTING

In NR standard, it supports beam reporting such that the UE can report beam information including measurement quantities for N downlink Tx beams and information indicating

Indoor Scenario

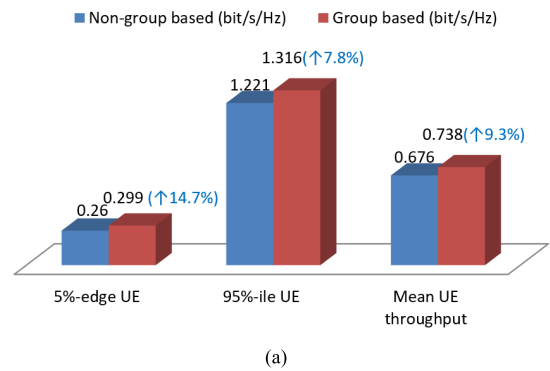

UMA Scenario

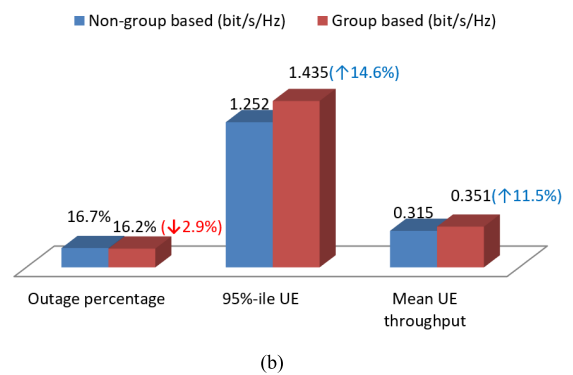

FIGURE 5. Performance comparison between group and non-group based reporting.

these N beams, i.e., DL RS ID(s). The measurement quantities can be in the form of reference signal received power (RSRP). Depending on whether beam grouping is performed or not, the beam reporting format can be further divided into two categories [24]:

- Group based reporting: The N downlink Tx beams in a reporting instance can be received simultaneously by the UE by multiple receive panels. This means that the subsequent DL transmission can be scheduled with up to N downlink Tx beams. For instance, as shown in Figure 1, the UE enables two antenna panels to simultaneously receive two independent Tx beams, which experience a line-of-sight (LOS) path and a strong non-line-of-sight (NLOS) path, respectively.
- Non group based reporting: UE reports the N downlink beams with the N -best received power without further UE assumption about simultaneous reception for these N beams. In the other word, the subsequent DL transmission can only be performed with only one Tx beam selected from the N beams since TRP does not know which beams can be simultaneously received by the UE.

With group based reporting, a UE can help a TRP to identify multi-path observed by the UE and let the TRP know the UE beam information implicitly. System level evaluation is done to compare these two reporting schemes i.e. non-group

based reporting and group based reporting, where $N = 2$. Evaluation results for indoor hotspot scenario and urban macro (UMA) scenario are respectively shown in Figure 5(a) and Figure 5(b). It can be observed that about 15% gain is obtained in both scenarios. For UMA scenario, it can be shown that outage percentage is quite high due to severe Outdoor-to-Indoor (O-to-I) penetration loss. The outage percentage is reduced with group-based reporting. In general, the gain comes from better support of multi-panel transmission schemes including spatial multiplexing, joint transmission and diversity given that group based reporting tends to report more meaningful spatial information by avoiding report of correlated beams. For example, the gain from cell center UEs in UMA scenarios mainly comes from performing spatial multiplexing with uncorrelated beams. While for cell edge UEs in UMA, better support of diversity is the major contribution to reduce the outage percentage in UMA. For indoor hotspot, it is for small coverage area but it is an interference limited scenario. Depending on dynamic traffic load from interfering cells, the experienced SINR can be dramatically changing in time. Group based reporting provides useful information to assist network on switching between different transmissions schemes according to channel and interference situation.

In 3GPP Release 15, $N = 2$ is supported for group based beam reporting, i.e., a UE can report up to 2 beams which can be received simultaneously by the UE by possibly two receive panels (i.e., only one downlink Tx beam per panel). In order to support more UE receive panels and more candidate beams for each UE receive panel, beam grouping is considered as one of the enhancement areas for future releases.

D. BEAM DETERMINATION AND INDICATION

Based on downlink Tx beams, measurement quantities and grouping information reported by UEs, the TRP determines the beam(s) used for data transmission. The most straightforward way for TRP to determine the beam is to follow UE recommendation and use the beam with the best reported RSRP for data transmission. However, it is not always the case considering multiple perspectives including multiuser transmission, interference coordination and channel reciprocity. TRP should have the flexibility to change or refine the beam according to its need. Hence, beam indication is required for TRP to inform UE which beams are used for data transmission so that the UE can use the corresponding proper receive beam for data reception.

Regarding beam indication, the TRP indicates the BF RS ID (instead of explicit Tx beam ID(s)) which represents the beam (group) of the data transmission. Equivalently, the TRP indicates the spatial channel properties information to the UE to assist UE-side beam-forming/reception as beam indication. This beam indication can be conducted via multi-stage indication for QCL among RS ports, via joint higher layer signaling and physical layer signaling to reduce the overhead while maintaining the flexibility of beam indication. In NR standard [29], up to 128 beams can be configured by Radio

Resource Control (RRC) layer signaling. Out of 128 candidate beams, up to 8 candidate beams can be selected by MAC layer signaling [28]. This requires 3 bits in physical layer signaling [30] which is used to indicate one final beam for data transmission. This is done for one TRP in Release 15. In Release 16, it is extended to support two TRPs so that 2 beams, each beam corresponding to each TRP, can be indicated by physical layer signaling. This enables joint transmission using multiple beams with coordination between two TRPs. In addition, overhead saving is introduced in Release 16 so that multiple carriers can share the same MAC layer signaling to simultaneously down-select the same set of 8 candidate beams. This is particularly useful for the cases that channels and dominant beams of multiple carriers are correlated so that update of the candidate beam pool can be done simultaneously.

For UL beam management without beam correspondence, the UE applies Tx beam which is transparent to the TRP on UL BF RS resource(s) for UL beam sweeping and measurement. However, different from DL beam management, TRP does not need to report the results of UL beam management to UEs. It just needs to indicate the index of measured UL BF RS resource which represents UL Tx beam(s).

E. BEAM MAINTENANCE

Beam maintenance (including beam tracking and refinement) is designed to handle the issues of beam misalignment caused by unexpected UE mobility as well as to support beam refinement from wide to narrow beams. To be more specific, it involves beam tracking or refinement per Tx/Rx beam(s) which can be supported by P2 and P3 respectively. Through probing neighboring beams, beam tracking can efficiently track and compensate the change of optimal transmission direction. Besides, beam refinement can be based on wide beam selected from P1. Multiple BF RS resources can be configured to perform beam sweeping of finer beams under the angular range of the selected wide beam. The procedure can be triggered by TRP with configurable number of sweeping beams for beam tracking/refinement. The UE may report the updated RSRP information based on finer beams. With flexible triggering of these procedures, the hierarchical beam search [31] can be supported to reduce the complexity and searching time compared to the exhaustive beam search.

In the case that link qualities are lower than expectation, TRP and UE would directly probe alternative beams with grouping indication before switching beam group for data/control channel and subsequently determine whether to switch its transmission beam group(s) to an alternative group accordingly. If the alternative group is found in the reported set, data can be transmitted continuously without outage or beam failure.

F. BEAM FAILURE RECOVERY

The directional communication introduced by beam based operation limits the multipath diversity and make the communication susceptible to channel fluctuation.

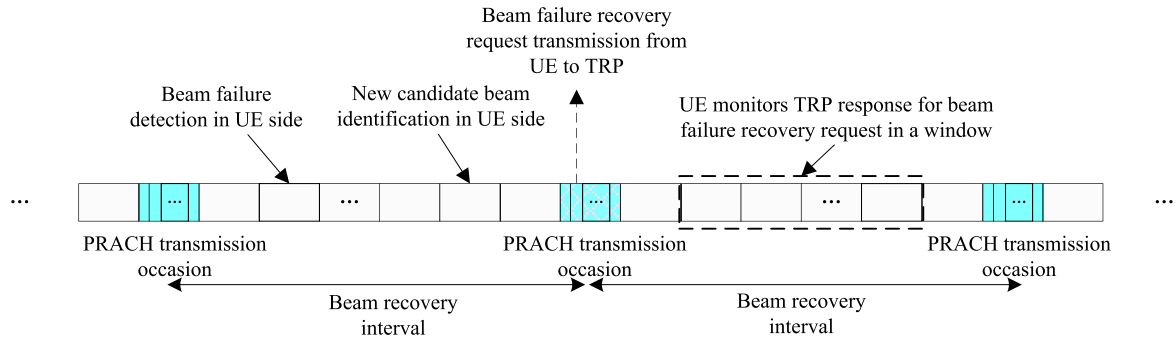

FIGURE 6. Beam failure recovery procedure.

Channel blockage, like human blockage, poses approximately 20dB attenuation [32]. Moreover, UE mobility, like rotation, may bring misalignment between Tx and Rx beams, which results in a significant loss on beam-forming gain when beam tracking fails.

If beam maintenance cannot work well and beam link failure for control channel occurs, UE initiated beam failure recovery, used for identifying new potential beam(s) and initiating beam recovery request, would be enabled accordingly. Beam failure recovery mechanism includes the following aspects:

- Beam failure detection
- New candidate beam identification
- Beam failure recovery request transmission
- UE monitoring TRP response for beam failure recovery request

A UE monitors the RS for beam failure detection to assess if any beam failure triggering condition has been met. Once the beam failure event is declared and if one or more new candidate beam(s) are identified, the beam recovery procedure is triggered as shown in Figure 6. Information carried by beam recovery request, including UE identifier and new candidate beam(s), would be delivered to TRP. After that, the UE monitors the corresponding control channel search space to receive TRP response for beam failure recovery request, which is transmitted by the new Tx beam(s) identified by the UE. To accelerate the procedure of beam recovery and ensure the robustness of this message delivery, non-contention based channel based on physical random access channel (PRACH) (instead of contention-based) can be used for carrying beam failure recovery request for primary cell in Release 15. In Release 16, uplink control channel is additionally supported for carrying beam failure recovery request for secondary cells in the case of carrier aggregation. After this beam failure recovery process, the TRP and UE can use the newly identified beam(s) for subsequent communication.

IV. CHALLENGES AND FUTURE TRENDS FOR BEYOND 5G

As the submission of 3GPP 5G solutions for IMT-2020 to ITU has been finalized in June 2019 [33], the standardization process for beyond 5G has been initialized and planned. For beam management, the motivation for beyond 5G is

to extend broader use cases and scenarios, e.g., ultra reliable & low latency communication (URLLC), mmWave MU-MIMO enhancement, and UE power saving, etc. In order to support these use cases, technical improvements for 5G beam management become indispensable.

In this section, challenges and further trends for beyond 5G beam management are analyzed. The potential topics for beyond 5G beam management include UL simultaneous transmission across multi-panel (STxMP), interference-aware beam management in MU-MIMO, UE centric panel management and artificial intelligence (AI) based beam management. Details of each topic are described in Parts A-D below.

A. UL SIMULTANEOUS TRANSMISSION ACROSS MULTI-PANEL (STxMP)

Antenna panel is a general terminology in standard to describe antenna sub-array or antenna beamforming module. For UEs supporting millimeter wave communication, a large single panel is not desirable due to physical limitation of UE form factor. In addition, increasing separation between antenna panels or placing multi-panels in different sides of a UE make the beam direction more distinct which enables higher dimension of spatial multiplexing. So, it is common to have multiple antenna panels in a UE supporting millimeter wave communication [34] where panels are placed along the top and bottom edges or on different sides of the UE so that each panel can point to different directions i.e. with different boresight. Even with multiple panels equipped in a UE, it is challenging to consider simultaneous transmission across multiple panels considering interference. Hence, 5G NR specification in Release 15 and Release 16 is generally based on typical scenario that there is a single available Tx panel in the UE side, which means that only one UL TX beam can be transmitted at a given time instant. With this limited flexibility on UL transmission, challenges are expected to be encountered to support scenarios like multi-TRP and Vehicle-to-everything (V2X) where simultaneous communication with different nodes is required. Therefore, multi-panel enhancement is considered as one of the essential features for beyond 5G evolution. In [35], uplink multi-panel MIMO for NR is briefly discussed. In next part of this section, more

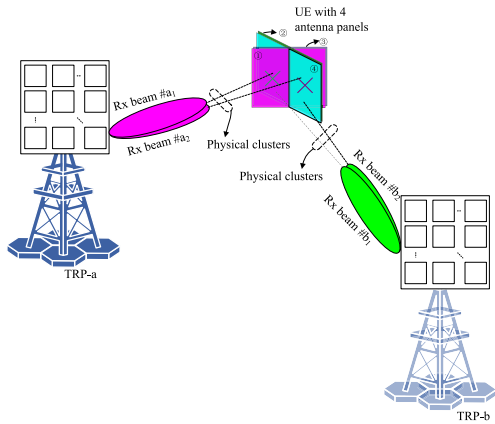

FIGURE 7. STxMP in multi-panel multi-TRP.

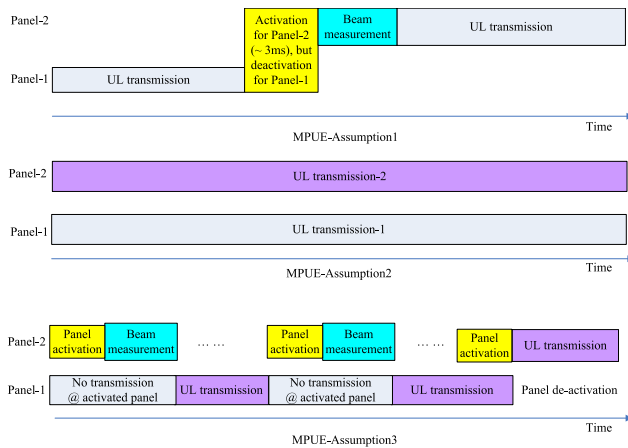

FIGURE 8. UE centric panel management.

details about multi-panel operation assumptions discussed in NR Release 16 are provided.

For both TRP and UE sides, there are multiple panels for UL transmission. In order to achieve high rank or multi-layer transmission, the TRP and UE should strive to use different beams generated from different panels, i.e., STxMP, with objective of sufficiently using capability of each panel. One typical scenario for STxMP is shown in Figure 7, where the UE is to simultaneously transmit uplink signals to two separate TRPs through using its 4 antenna panels. Proper interference coordination for multi-panel simultaneous transmission to different multi-TRP is required.

One challenge for the network to support simultaneous UL transmission across multiple panels is various possible hardware architecture at UE which results in different UE capabilities. Taking into account these different capabilities, UEs with multiple panels can be divided into the following categories, which is shown in Figure 8.

- Multi-panel UE (MPUE)-Assumption1: Multiple panels are implemented on a UE and only one panel can be activated at a time, with panel switching/activation delay, e.g., 3 ms.
- MPUE-Assumption2: Multiple panels are implemented on a UE and multiple panels can be activated at a time and one or more panels can be used for transmission

- MPUE-Assumption3: Multiple panels are implemented on a UE and multiple panels can be activated at a time but only one panel can be used for transmission

Since TRP is unaware of some real-time information at UE side, e.g., blockage, overheat or low-power mode, UE centric panel management should be considered. This means that panel state, e.g., sleep or active, can be determined by UE side, and only active panels can be scheduled by TRP side. To guarantee the same understanding of UE panel state, the following issues should be fully studied.

- Panel-specific information can be reported to TRP from UE in order to enable panel-specific information interaction between TRP and UE sides. To be more specific, determination of panel state (e.g. active or inactive state) can be divided into three categories: (a) UE panel state is up to UE’s decision; (b) UE panel state can be requested by UE but it is up to TRP’s configuration/confirmation; (c) upper bound of active UE panel can be flexibly requested by UE assistance information, but UE panel states are up to TRP configurations.
- The configuration framework for transmission parameters and corresponding timeline for panel switching should be considered to be grouped or switched together, in order to support dynamic panel switching. When UE panel state (e.g., two active panels) is switched to another state (e.g., an active panel), the transmission parameters for UL channel and reference signals should be updated simultaneously under a pre-defined timeline.

B. INTERFERENCE AWARE BEAM MANAGEMENT IN MU-MIMO

In 5G NR, the UE reports N Tx beams (i.e., downlink (DL) reference signal (RS) index) and its corresponding L1-RSRP results. Subsequently TRP will select one beam from candidate set according to beam reporting and its scheduling schemes. However, sometimes this kind of selection criterion cannot reflect the actual quality of selected beams, for the perspective of data transmission.

- To be more specific, the RSRP is defined as the linear average (in [W]) over the power contribution of the resource elements that carry the corresponding DL RSs for measurement, where the power per resource element is determined from the energy received during the useful part of symbol, excluding cyclic prefix (CP).

The RSRP can only represent the receive power corresponding to the DL RS without considering impact of interference and noise power. Hence, this cannot represent transmission performance accurately, i.e., block-error-rate (BLER). Different interference level may be observed for different beam link, and as a result, one beam link with larger RSRP may have worst BLER performance than that with smaller RSRP. For instance, the antenna groups in TRP are divided into several groups, each of which is to independently serve one UE in MU-MIMO scenarios, as shown in Figure 9, where there are three TRP antenna groups of {panel-1, panel-2}, {panel-3} and {panel-4} for UE-a,

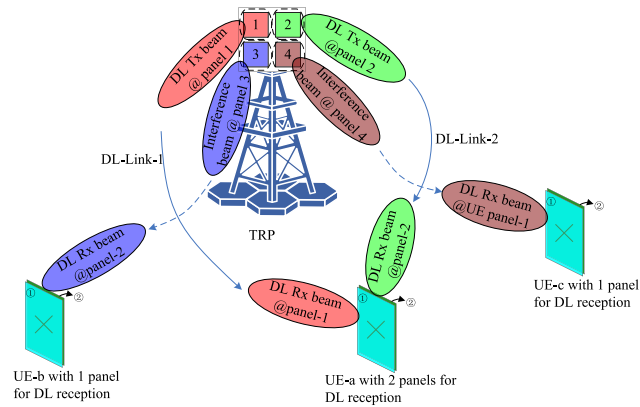

FIGURE 9. Interference aware beam management in MU-MIMO.

UE-b and UE-c, respectively. The challenge of this scenario is to support beam selection for different UEs taking into account of MU interference. Interference aware beam management can help in the aspects of beam reporting and beam indication.

- **Low-interference beam reporting:** For one given transmission, interference is not only related to Tx beam indication for UE specific transmission, e.g., DL RS for channel measurement, but also related to scheduling for other UEs, i.e., Tx beam for other UEs in MU-MIMO, due to the direction of interference transmission. The level of interference may depend on UE-side Rx beamforming, which means that, for different Tx-Rx beam links, different levels of interference are observed from different interfering beams. Consequently, information of low-interference beam ID(s) reported from each UE along with the recommended beam ID for transmission, is helpful for the assistance of beam scheduling for MU-MIMO and multi-TRP transmission. In [36], [37], the comprehensive simulation results are shown to demonstrate the effectiveness of this low-interference beam reporting.
- **Beam indication with interference-beam information** should be considered for optimizing UE side beamforming. Given the same DL RS as a reference for beam indication for the channel part, UE behavior for determination of Rx beamforming weights with different assumptions of interference beam(s) can be different. For example, with the knowledge of both channel part and interference part, receive beamforming can be partitioned into two parts for data-signal enhancement and interference nulling respectively [38]. The partitioning relies on the decomposition of analog beamforming vectors and path observation vectors into Kronecker products of factors being uni-modulus vectors. Different factors of the analog beamformer are designed for either nulling interference paths or coherently combining data paths. Therefore, from UE perspective, the signaling for beam indication should also provide the interference beam information so that the UE can perform proper partitioning of receive analog beamforming.

In Release 16, support of layer 1 SINR reporting from UE has been introduced which provides base station a fast layer 1 metric considering interference. However, reporting further information on interference and beam indication of interference has not been standardized yet. To support advanced multi-user schemes studied in the existing work in this area, enhancements on beam reporting and indication should be considered for the future releases of 5G or beyond. With support of these enhancements, the proposals in [39] such as multi-user beam training and inter-user interference coordination can be realized in the network. In addition, support of interference aware beam reporting enables the network to implement multiple resource allocation schemes considering multi-user hybrid beamforming described in [40]. Moreover, enhancements on interference aware beam reporting and beam indication can be considered for supporting more advanced form of multi-user access like NOMA multi-user systems [41], [42]. In addition to spatial domain information of interfering beam, power domain information can be recommended by UE to assist BS scheduling and power allocation. Along with beam indication, power domain information can be indicated to UE to assist UE receiver for interference cancellation.

C. ARTIFICIAL INTELLIGENCE BASED BEAM MANAGEMENT

Application of Artificial Intelligence (AI) algorithms including machine learning (ML) algorithms in communication networks has drawn a lot of interest in recent research. It has been started that AI algorithms are used for deployment of 5G networks. It is expected that AI applications will be more widely used in the network or even UE implementation. In general, AI is a tool to help network to make a quicker and wiser decision based on training data in the past. The potential benefits of standardization support are feedback/control signaling overhead reduction, more accurate feedback and enabling better AI algorithms which require coordination between base station and UE. These potential benefits will then translate to better system performance, e.g., in terms of throughput and reliability. AI can be applied in the following two beam management aspects:

- **Beam-forming training [43]–[45]:** For mmWave channels, contributions from most of the non-coherent paths would be negligible due to the fact that their powers are below noise floor of receiver. The dominant paths that are used to support subsequent data transmissions are limited. Machine-learning for beam training considering the sparse nature of the mmWave channels [43] is a trend for massive beam-forming training, taking into account that the number of dominant beam pairs is far less than the total number of candidate pairs. Besides, the system should balance various performance metrics, e.g., average throughput, cell-edge throughput, and intra/inter-cell interference mitigation/coordination, when performing multi-UE beam management in dense mmWave network. The deep learning based beam

management becomes a powerful tool to mitigate the complexity of radio resource management problem. In [44], a deep-learning based beam management and interference coordination is proposed, and herein the beam direction, beamwidth and transmit power of each beam can be optimized simultaneously. In [45], learning based beam training is evaluated against conventional method of exhaustive beam search. It can be shown that lower latency and higher throughput can be achieved by using learning based beam training which can learn the environments with consideration of blockage. In this case, history like channel correlation/blockage of a UE can be reported by the UE or exchanged by different base stations.

- Beam tracking [17], [46]–[48]: Beam tracking is a widely-adopted approach to address the problem of device mobility. By probing neighboring steerable beams, it can efficiently track and compensate the change of optimal communication orientation. However, the mobility information such as speed and direction for a given device can be uncertain if there is no history information. Consequently, learning of UE-specific beam switching, taking into account factors like direction, velocity and location, is important for determining the number and range of probing beams for beam tracking. Training data can be collected from UE behavior related to UE mobility. Beam switching can be then determined based on predicted or reported UE moving trajectory. In [17], an online beam pair selection and refinement algorithm is proposed. Compared to offline approach, online learning enables update to the database by collecting new observations during beam tracking operation. It is expected that online and offline approaches would have different standardization impact. In [47], a machine learning solution is proposed to enhance beam management and multiuser scheduling by modeling the mapping between geo-locations of UEs and their serving beams or serving cells in a multi-user multi-cell environment. In [48], it showed that overhead of pilots can be saved by predicting CSI based on the past CSI using machine learning algorithm. This can potentially have standardization impact on flexible pilot assignment indicated by the base station depending on the machine learning algorithm implemented in the base station.

To support AI based beam management in 3GPP standard, it may not be necessary to standardize different types of neural network since it can be up to BS or UE’s implementation to decide which type of AI algorithm is used. The standardization support to AI based beam management is mostly to define signaling framework to facilitate AI based beam management. There are four examples as shown in Figure 10.

- In Figure 10a, feedback on UE mobility information by UE is standardized so that it can be used as an input to the neural network at BS for AI based beam management.

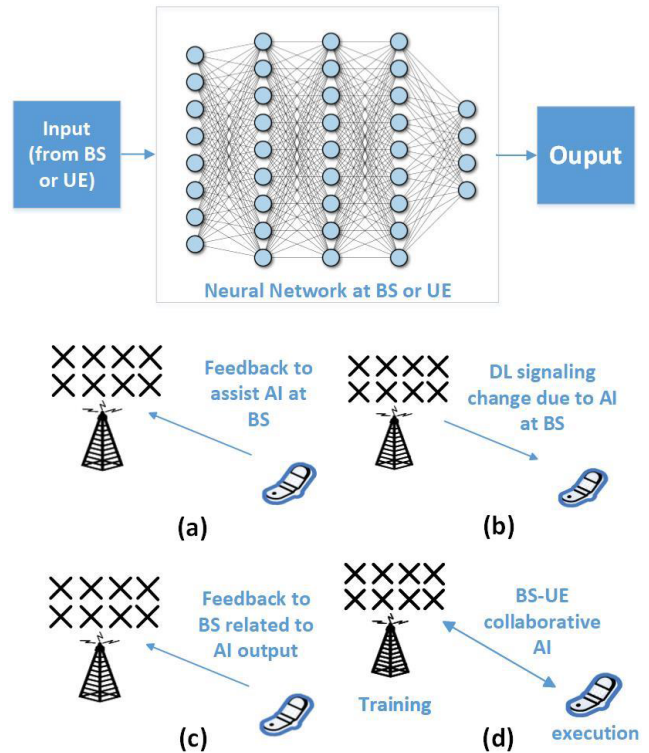

FIGURE 10. Standardization impact on AI based beam management.

- In Figure 10b, AI based beam management for future beam prediction is done at BS and signaling of future beam indication information with time stamps can be indicated to UE.
- In Figure 10c, neural network is implemented at UE side in this case. Feedback is standardized to support AI output results from UE e.g. beam prediction results or recommended demodulation pilot information from UE.
- In Figure 10d, collaborative AI is done between BS and UE. The BS performs training and downloads the trained neural network to the UE. The execution is done at UE to generate the output for final beam prediction result. In this case, it potentially requires more standardization effort compared to the above three cases. The standard needs to define the mechanism to download the neural network. The structure of the neural network may need to be standardized. For different use cases, the required structure of neural network can be different. Hence it can be challenging to have standardization support on collaborative AI between BS and UE.

V. CONCLUSION

In this paper, we provide an overview on the standardized MIMO framework supporting beam management and CSI acquisition in 5G NR. Flexible and scalable multi-stage feedback framework is introduced to achieve the common framework for various situations considering factors such as scenarios, beamforming structures, frequency bands and levels of channel reciprocity. The 5G NR standard supports beam

management procedure including beam sweeping, beam measurement, beam reporting, beam indication, beam maintenance and beam failure recovery. For beam reporting, evaluation is conducted to show the gain of beam group based reporting compared to non-group based reporting. Moreover, challenges and future trends for beyond 5G evolution on mmWave beam management are discussed. Particularly, topics of simultaneous multi-panel transmission, interference-aware beam management for MU-MIMO and AI based beam management are considered as future trends for beyond 5G evolution.

REFERENCES

- [1] *Study on New Radio Access Technology—Physical Layer Aspects*, document TR 38.802, V14.1.0, 3GPP, Jun. 2017. [Online]. Available: <http://ftp.3gpp.org>
- [2] *Study on Scenarios and Requirements for Next Generation Access Technologies*, document TR 38.913, V14.3.0, 3GPP, Jun. 2017. [Online]. Available: <http://ftp.3gpp.org>
- [3] Y. Niu, Y. Li, D. Jin, L. Su, and A. V. Vasilakos, "A survey of millimeter wave communications (mmWave) for 5G: Opportunities and challenges," *Wireless Netw.*, vol. 21, no. 8, pp. 2657–2676, Nov. 2015.
- [4] O. E. Ayach, S. Rajagopal, S. Abu-Surra, Z. Pi, and R. W. Heath, Jr., "Spatially sparse precoding in millimeter wave MIMO systems," *IEEE Trans. Wireless Commun.*, vol. 13, no. 3, pp. 1499–1513, Mar. 2014.
- [5] *Study on Elevation Beamforming / Full-Dimension (FD) Multiple Input Multiple Output (MIMO) for LTE*, document TR36.897, V13.0.0, 3GPP, Jun. 2015. [Online]. Available: <http://ftp.3gpp.org>
- [6] F. Sahrabi and W. Yu, "Hybrid digital and analog beamforming design for large-scale antenna arrays," *IEEE J. Sel. Topics Signal Process.*, vol. 10, no. 3, pp. 501–513, Apr. 2016.
- [7] F. Sahrabi and W. Yu, "Hybrid beamforming with finite-resolution phase shifters for large-scale MIMO systems," in *Proc. IEEE 16th Int. Workshop Signal Process. Adv. Wireless Commun.*, Stockholm, Sweden, Jul. 2015, pp. 136–140.
- [8] X. Yu, J.-C. Shen, J. Zhang, and K. B. Letaief, "Alternating minimization algorithms for hybrid precoding in millimeter wave MIMO systems," *IEEE J. Sel. Topics Signal Process.*, vol. 10, no. 3, pp. 485–500, Apr. 2016.
- [9] R. Mendez-Rial, C. Rusu, A. Alkhateeb, N. Gonzalez-Prelcic, and R. W. Heath, Jr., "Channel estimation and hybrid combining for mmWave: Phase shifters or switches?" in *Proc. Inf. Theory Appl. Workshop (ITA)*, San Diego, CA, USA, Feb. 2015, pp. 90–97.
- [10] W. Zhang, J. Xiang, Y.-N.-R. Li, Y. Wang, Y. Chen, P. Geng, and Z. Lu, "Field trial and future enhancements for TDD massive MIMO networks," in *Proc. IEEE 26th Annu. Int. Symp. Pers., Indoor, Mobile Radio Commun. (PIMRC)*, Aug. 2015, pp. 2339–2343.
- [11] A. Ghosh, R. Ratasuk, B. Mondal, N. Mangalvedhe, and T. A. Thomas, "LTE-advanced: Next-generation wireless broadband technology," *IEEE Wireless Commun.*, vol. 17, no. 3, pp. 10–22, Jun. 2010.
- [12] Z. Xiao, P. Xia, and X.-G. Xia, "Enabling UAV cellular with millimeter-wave communication: Potentials and approaches," *IEEE Commun. Mag.*, vol. 54, no. 5, pp. 66–73, May 2016.
- [13] S. Jayaprakasam, X. Ma, J. W. Choi, and S. Kim, "Robust beam-tracking for mmWave mobile communications," *IEEE Commun. Lett.*, vol. 21, no. 12, pp. 2654–2657, Dec. 2017.
- [14] S. Kim, H. Han, N. Kim, and H. Park, "Robust beam tracking algorithm for mmWave MIMO systems in mobile environments," in *Proc. IEEE 90th Veh. Technol. Conf. (VTC-Fall)*, Sep. 2019.
- [15] N. Garcia, H. Wymeersch, E. G. Ström, and D. Slock, "Location aided mm-wave channel estimation for vehicular communication," in *Proc. IEEE 17th Int. Workshop Signal Process. Adv. Wireless Commun. (SPAWC)*, Jul. 2016, pp. 1–5.
- [16] V. Va, J. Choi, T. Shimizu, G. Bansal, and R. W. Heath, Jr., "Inverse multipath fingerprinting for millimeter wave V2I beam alignment," *IEEE Trans. Veh. Technol.*, vol. 67, no. 5, pp. 4042–4058, May 2018.
- [17] V. Va, T. Shimizu, G. Bansal, and R. W. Heath, Jr., "Online learning for position-aided millimeter wave beam training," *IEEE Access*, vol. 7, pp. 30507–30526, 2019.
- [18] E. Onggosanusi, M. S. Rahman, L. Guo, Y. Kwak, H. Noh, Y. Kim, S. Faxer, M. Harrison, M. Frenne, S. Grant, R. Chen, R. Tamrakar, and A. Q. Gao, "Modular and high-resolution channel state information and beam management for 5G new radio," *IEEE Commun. Mag.*, vol. 56, no. 3, pp. 48–55, Mar. 2018.
- [19] M. Giordani, M. Polese, A. Roy, D. Castor, and M. Zorzi, "Standalone and non-standalone beam management for 3GPP NR at mmWaves," *IEEE Commun. Mag.*, vol. 57, no. 4, pp. 123–129, Apr. 2019.
- [20] M. Giordani, M. Polese, A. Roy, D. Castor, and M. Zorzi, "A tutorial on beam management for 3GPP NR at mmWave frequencies," *IEEE Commun. Surveys Tuts.*, vol. 21, no. 1, pp. 173–196, 1st Quart., 2019.
- [21] *On CSI-RS for Beam Management*, document RAN1 R1-1700134, RAN1-NRAdhoc, ZTE, 3GPP, Jan. 2017.
- [22] *Physical Layer Measurements (Release 15)*, document TS 38.215, V15.4.0, 3GPP, Dec. 2018. [Online]. Available: <http://ftp.3gpp.org>
- [23] *Discussion on SRS Design for NR*, document RAN1 R1-1717435, RAN1#90bis, 3GPP, ZTE, Prague, CZ, USA, Oct. 2017.
- [24] *NR Physical Layer Procedures for Data (Release 15)*, document TS 38.214, V15.4.0, 3GPP, Dec. 2018. [Online]. Available: <http://ftp.3gpp.org>
- [25] H. Ji, Y. Kim, J. Lee, E. Onggosanusi, Y. Nam, J. Zhang, B. Lee, and B. Shim, "Overview of full-dimension MIMO in LTE-advanced pro," *IEEE Commun. Mag.*, vol. 55, no. 2, pp. 176–184, Feb. 2017.
- [26] *Beamforming Procedure Considering High Frequency Channel Characteristics*, document RAN1 R1-1700126, RAN1-NRAdhoc, ZTE, 3GPP, Jan. 2017.
- [27] *On the Impact of UE Rotation*, document RAN1 R1-1609248, RAN1#86bis, LG Electronics, 3GPP, Oct. 2016.
- [28] *Medium Access Control (MAC) Protocol Specification (Release 15)*, document TS 38.321, V15.4.0, 3GPP, Dec. 2018. [Online]. Available: <http://ftp.3gpp.org>
- [29] *Radio Resource Control (RRC) Protocol Specification (Release 15)*, document TS 38.331, V15.4.0, 3GPP, Dec. 2018. [Online]. Available: <http://ftp.3gpp.org>
- [30] *Multiplexing and Channel Coding (Release 15)*, document TS 38.212, V15.4.0, 3GPP, Dec. 2018. [Online]. Available: <http://ftp.3gpp.org>
- [31] Z. Xiao, T. He, P. Xia, and X.-G. Xia, "Hierarchical codebook design for beamforming training in millimeter-wave communication," *IEEE Trans. Wireless Commun.*, vol. 15, no. 5, pp. 3380–3392, May 2016.
- [32] M. Jacob, C. Mbianke, and T. Kurner, "A dynamic 60 GHz radio channel model for system level simulations with MAC protocols for IEEE 802.11ad," in *Proc. IEEE Int. Symp. Consum. Electron. (ISCE)*, Jun. 2010, pp. 1–5.
- [33] *3GPP Final Technology Submission—Overview of 3GPP 5G Solutions for IMT-2020*, document ITU-R WP5D, Alliance for Telecommunications Industry Solutions, Jun. 2019.
- [34] Y. Huo, X. Dong, W. Xu, and M. Yuen, "Enabling multi-functional 5G and beyond user equipment: A survey and tutorial," *IEEE Access*, vol. 7, pp. 116975–117008, 2019.
- [35] Y. Huang, Y. Li, H. Ren, J. Lu, and W. Zhang, "Multi-panel MIMO in 5G," *IEEE Commun. Mag.*, vol. 56, no. 3, pp. 56–61, Mar. 2018.
- [36] *Details and LLS Evaluation on LI-SINR Measurement and Reporting*, document RAN1 R1-1906248, RAN1#97, 3GPP, ZTE, Reno, NV, USA, May 2019.
- [37] *Details and SLS Evaluation on LI-SINR Measurement and Reporting*, document RAN1 R1-1906249, RAN1#97, ZTE, 3GPP, Reno, NV, USA, May 2019.
- [38] G. Zhu, K. Huang, V. K. N. Lau, B. Xia, X. Li, and S. Zhang, "Hybrid beamforming via the kronecker decomposition for the millimeter-wave massive MIMO systems," *IEEE J. Sel. Areas Commun.*, vol. 35, no. 9, pp. 2097–2114, Sep. 2017.
- [39] Q. Xue, X. Fang, M. Xiao, S. Mumtaz, and J. Rodriguez, "Beam management for millimeter-wave beamspace MU-MIMO systems," *IEEE Trans. Commun.*, vol. 67, no. 1, pp. 205–217, Jan. 2019.
- [40] I. Ahmed, H. Khammari, and A. Shahid, "Resource allocation for transmit hybrid beamforming in decoupled millimeter-wave multiuser-MIMO downlink," *IEEE Access*, vol. 5, pp. 170–182, 2017.
- [41] Z. Xiao, L. Zhu, J. Choi, X. Chao, and X. G. Xia, "Joint power allocation and beamforming for non-orthogonal multiple access (NOMA) in 5G millimeter-wave communications," *IEEE Trans. Wireless Commun.*, vol. 17, no. 5, pp. 2961–2974, May 2018.
- [42] Z. Xiao, L. Zhu, Z. Gao, D. O. Wu, and X. G. Xia, "User fairness non-orthogonal multiple access (NOMA) for 5G millimeter-wave communications with analog beamforming," *IEEE Trans. Wireless Commun.*, vol. 18, no. 7, pp. 1276–1536, Jul. 2019.

[43] Y. Ding, L. Su, and D. Jin, "New fast multi-user beam training scheme based on compressed sensing theory for millimetre-wave communication," *IET Commun.*, vol. 13, no. 6, pp. 642–648, Apr. 2019.

[44] P. Zhou, X. Fang, X. Wang, Y. Long, R. He, and X. Han, "Deep learning-based beam management and interference coordination in dense mmWave networks," *IEEE Trans. Veh. Technol.*, vol. 68, no. 1, pp. 592–603, Jan. 2019.

[45] T. W. Chang, L. H. Shen, and K. T. Feng, "Learning-based beam training algorithms for IEEE802.11ad/ay networks," in *Proc. IEEE 89th VTC-Spring*, Apr. 2019.

[46] Y. Wang, M. Narasimha, and R. W. Heath, Jr., "MmWave beam prediction with situational awareness: A machine learning approach," in *Proc. IEEE 19th Int. Workshop Signal Process. Adv. Wireless Commun. (SPAWC)*, Jun. 2018.

[47] M. Arvinte, M. Tavares, and D. Samardzija, "Beam management in 5G NR using geolocation side information," in *Proc. 53rd Annu. Conf. Inf. Sci. Syst. (CISS)*, Mar. 2019.

[48] Y. Guo, Z. Wang, M. Li, and Q. Liu, "Machine learning based mmWave channel tracking in vehicular scenario," in *Proc. IEEE Int. Conf. Commun. Workshops (ICC Workshops)*, May 2019.



XIAODAN ZHANG received the Ph.D. degree in decision science from the Macau University of Science and Technology, in 2016. After nine years of related working experience in ZTE Corporation, she is currently an Associate Research Fellow with the Shenzhen Institute of Information Technology. Her research interests include 5G wireless communications, artificial intelligence, modeling and optimization, decision analysis, and supply chain management. In 2017, she is recognized as Overseas High-Caliber Personnel (Level A) in Shenzhen.



KAIBIN HUANG (Senior Member, IEEE) received the B.Eng. (Hons.) and M.Eng. degrees from the National University of Singapore, and the Ph.D. degree from The University of Texas at Austin (UT Austin), all in electrical engineering. Since January 2014, he has been an Assistant Professor with the Department of Electrical and Electronic Engineering (EEE), The University of Hong Kong. He used to be a Faculty Member in the Department of Applied Mathematics (AMA), The Hong Kong Polytechnic University (PolyU), and the Department of EEE, Yonsei University. His research interests include MIMO communications, wireless power transfer, and machine learning. Dr. Huang was an Elected Member of the SPCOM Technical Committee of the IEEE Signal Processing Society, from 2012 to 2015. He received from the IEEE ComSo the 2018 Best Tutorial Paper Award, the 2015 Asia Pacific Outstanding Paper Award, the Outstanding Teaching Award from Yonsei, the Motorola Partnerships in Research Grant, and the University Continuing Fellowship from UT Austin, and Best Paper Awards from IEEE GLOBECOM 2006 and IEEE/CIC ICC, in 2018. He held a University Visiting Scholarship at Kansai University, Japan, in the summer of 2017. He frequently serves on the technical program committees of major IEEE conferences in wireless communications. Most recently, he served as the Lead Chairs for the Wireless Communication Symposium of IEEE Globecom 2017, the Communication Theory Symposium of IEEE GLOBECOM 2014, and the TPC Co-Chairs for IEEE PIMRC 2017, and the IEEE CTW 2013. He has also served as Associate Editors for the IEEE TRANSACTIONS ON WIRELESS COMMUNICATIONS, the IEEE JOURNAL ON SELECTED AREAS IN COMMUNICATIONS (JSAC) series on GREEN COMMUNICATIONS AND NETWORKING, and the IEEE WIRELESS COMMUNICATIONS LETTERS. He is currently an Associate Editor of the IEEE TRANSACTIONS ON GREEN COMMUNICATIONS AND NETWORKING. He has edited the JSAC 2015 special issue on communications powered by energy harvesting.

...



YU-NGOK RUYUE LI received the B.Eng. (EEE) degree (Hons.) from The University of Hong Kong, in 2000, and the M.S. degree in electrical engineering from Stanford University, in 2002. Prior to ZTE, he worked for several telecommunication and semiconductor companies including Qualcomm and Marvell Semiconductor on the projects related to 2G/3G baseband algorithm design and LTE standardization. He is currently a Chief Engineer of Wireless Product Research and Development Institute, ZTE Corporation. He is actively involved in research and standardization activities in wireless communication. He is the Chief Standard Delegate and Project Manager leading the ZTE standard team in 3GPP RAN and RAN WGs. His research focuses on physical layer system algorithms and network optimization in the cellular communication area. His current interest topics include massive MIMO, mmWave communications, beam management, AI applications on MIMO, URLLC, CoMP, and interference coordination.



BO GAO received the B.S. degree from the China University of Geosciences, Wuhan, China, in 2010, and the Ph.D. degree in information and communication engineering from Tsinghua University, Beijing, China, in 2015. He joined the 5G/NR standard team of ZTE Corporation, in 2015, working with mmWave communications, beam management, and UL power control technologies.