

Received December 8, 2019, accepted December 20, 2019, date of publication December 24, 2019, date of current version January 3, 2020.

Digital Object Identifier 10.1109/ACCESS.2019.2962074

A Novel Step Optimal Path Planning Algorithm for the Spherical Mobile Robot Based on Fuzzy Control

JIAN GUO¹, (Fellow, IEEE), CHUNYING LI¹, (Student Member, IEEE),
AND SHUXIANG GUO^{1,2,3}, (Senior Member, IEEE)

¹Tianjin Key Laboratory for Intelligent Robot Laboratory, Tianjin University of Technology, Tianjin 300384, China

²School of Life Science, Key Laboratory of Convergence Medical Engineering System and Healthcare Technology, the Ministry of Industry and Information Technology, The Institute of Advanced Biomedical Engineering System, Beijing Institute of Technology, Beijing 100081, China

³Department of Intelligent Mechanical Systems Engineering, Faculty of Engineering, Kagawa University, Takamatsu 761-0396, Japan

Corresponding author: Shuxiang Guo (27929579@qq.com)

This work was supported in part by the National Natural Science Foundation of China under Grant 61703305, in part by the Key Research Program of the Natural Science Foundation of Tianjin under Grant 18JCZDJC38500, and in part by the Innovative Cooperation Project of Tianjin Scientific and Technological under Grant 18PTZWHZ00090.

ABSTRACT In order to improve the ability of the spherical mobile robot to navigate and move autonomously in an unknown environment. This paper proposed a novel step optimal path planning method based on fuzzy control. Firstly, by analyzing the motion model of the spherical mobile robot, the arrangement and debugging of the ultrasonic sensors (HC-SR04) were completed. Then, through multi-sensor fusion technology and D-H parameter method, a fuzzy controller for the spherical mobile robot was designed. Finally, the proposed fuzzy control method was applied to the path planning of spherical mobile robot in unknown environment, and tested by a series of simulations and experiments. The results showed that the step optimal method based on fuzzy control could ensure that the spherical mobile robot completed the path planning. The experimental results also verified the effectiveness and practicability of the proposed novel path planning method.

INDEX TERMS Spherical mobile robot, step optimal, fuzzy control.

I. INTRODUCTION

Currently, the true meaning of the autonomous navigation capability of robots is the ability to interact with the external environment [1]. An important aspect of this interaction is the ability to have global path planning, dynamic re-planning and obstacle avoidance in emergencies. The autonomous navigation capability improves the operational performance of robots, which facilitates better development and utilization of resources [2]. Countries, therefore, are committed to the development of path planning technology, and new control methods and multi-functional robots are being born, and have achieved fruitful results.

A. RELATED WORK

Developed by the Swedish company Rotundus, the Ground-Bot spherical robot can adapt to various terrains, such as

The associate editor coordinating the review of this manuscript and approving it for publication was Fatos Xhafa¹.

sand, mud, snow, and also can achieve rolling on land [3]. The robot can use the built-in camera and various sensors to complete the collection of intelligence and the detection of special environments [4]. The egg-shaped robot developed by the Massachusetts Institute of Technology (MIT) can be used for port security inspections and underwater detection tasks. It uses the internally installed ultrasonic scanner to perform inspections of contraband on the ship and cracks in the nuclear reactor tank [5]. The AQUA robot developed by McGill University in Canada controls the movement through the fins, which can perform wired or short-range wireless operation for underwater environment monitoring [6]. The night patrol robot developed by the University of Electronic Science and Technology can perform dynamic and all-round detection of the nighttime environment without humans. It complete path planning through RFID acquisition system [7]. Through the analysis of the above research, path planning technology is of great significance for robots to explore resources and perform various special tasks. However, when robots perform the exploration tasks, most environments are

dynamic and unknown, and map construction is difficult. So it is necessary to research the path planning of robots in unknown environment.

In our previous work, we designed a spherical amphibious robot inspired by turtles [8], [9]. The robot uses a bionic four-legged crawl on the land and uses water jets to propel in the water. In order to carry more sensors and improve locomotion performance for the exploration in unknown environment. This paper uses the method of optimizing the step size to complete the path planning of the spherical robot in an unknown environment.

The study of path planning is of great significance to improve the level of intelligence, autonomous navigation and operation [10]. Currently, local path planning methods are widely used in unknown environments. Including potential field method, grid method and fuzzy logic method.

In the above methods, the basic idea of the potential field method is to establish a virtual force field. In the process of motion, the target generates attractiveness to the robot; The obstacle generates repulsive force to the robot. The resultant force of attractiveness and repulsion is used as the control force of the robot motion. Thus the robot can avoid obstacles and reach the target position. The potential field method has a small amount of calculation and a simple structure, which is convenient for real-time control of the bottom layer [11]. However, there are some defects, such as local minimum problem, which may cause path planning to fail. The grid method is to decompose the working environment of the robot into interconnected and non-overlapping grid cells. The grid information is recorded by the grid, and the grid with more accumulated values indicates that there is a higher possibility of obstacles. It is suitable for path planning of known environmental [12]. The grid size division directly affects the performance of the control algorithm. There is a local minimum problem, and the ability to find the path in a dense environment is weak. The fuzzy logic method uses the way of approximating natural language, which can deal with the uncertainty data well and realize the mapping relationship between input and output [13]. The fuzzy logic method is less affected by the external environment. It is suitable for path planning of robots in an unknown environment. It has good real-time performance. It also overcomes the problem that the potential field method is easy to produce local minimum and reduces the amount of calculation. The spherical robot this paper used is time-delay nonlinear unstable systems, and fuzzy control can perform nonlinear mapping from input space to output space.

B. CONTRIBUTIONS

Due to the limited detection distance of the sensor and the uncertainty of the surrounding environment, it is difficult to plan the path from the overall optimal [14]. In order to improve the adaptability of the spherical robot in an unstructured environment. Autonomous navigation capability is actually a kind of fuzzy control behavior. So this paper

uses fuzzy control to study the path planning of the spherical robot this paper used. Our contributions are:

1) This paper introduces a step size optimization algorithm based on fuzzy control. The purpose is to improve the autonomous movement ability and obstacle avoidance ability of the spherical robot. The control algorithm completes the setting of the end effector parameters by analyzing the motion model of spherical robot. The biggest difference from the traditional fuzzy control methods that provide evaluation functions for path planning constraints. Our method implements self-adjust by real-time feedback of robot position and actuator parameters, which solves navigation problems in unknown and complex environments.

2) The range of sensor detection is limited. Our method, therefore, completes the acquisition of the surrounding environment by fusing multi-sensor information, which improves the flexibility and sensitivity of the spherical robot in the unknown environment.

3) Through the construction of Simulink simulation, the path planning experiments of the spherical robot in unknown environment, complex environment and dynamic environment are completed. This paper analyzes and tests the motion state of the spherical robot. Experiments in various environments have proved that our method can effectively improve the performance of the spherical robot this paper designed.

The remainder of this paper is organized as follows. The methodology is presented in Section II, which includes the following subsections: the application of D-H parameter method, constraint of spherical mobile robot evaluation function, multi-sensor fusion strategy. The design and simulation of the fuzzy controller will be presented in Section III. Experiments in the concave environment, the complex environment and the moving environment are conducted in Section IV and the performance evaluation of the fuzzy control method is presented. Section V summarizes the contributions and future work.

II. METHODOLOGY

The position of the spherical mobile robot during the motion determines the success or failure of the path planning. The driving legs of the robot are connected by a multi-link structure. Each drive leg has multiple degrees of freedom, so the robot is a nonlinear system. The parameters of each joint and end effector position will affect the performance of the robot in an unknown environment. Therefore, this paper uses the following control strategy, as shown in Fig. 1.

A. APPLICATION OF D-H PARAMETER METHOD

The D-H parameter method can effectively describe the coordinate direction and parameters between adjacent links of the robot. Any adjacent coordinate system can be obtained by translation and rotation transformation. Through the D-H parameter method, this paper builds the coordinate system of

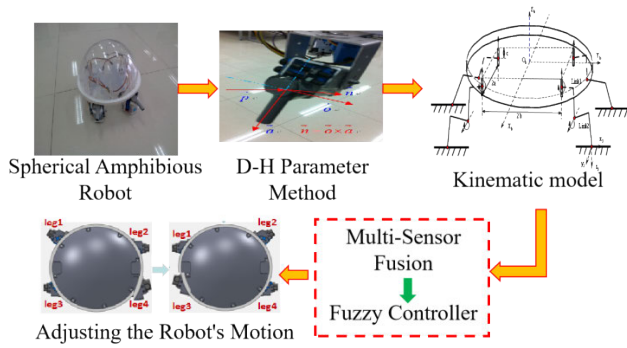

FIGURE 1. Step optimization strategy for the spherical mobile robot this paper designed.

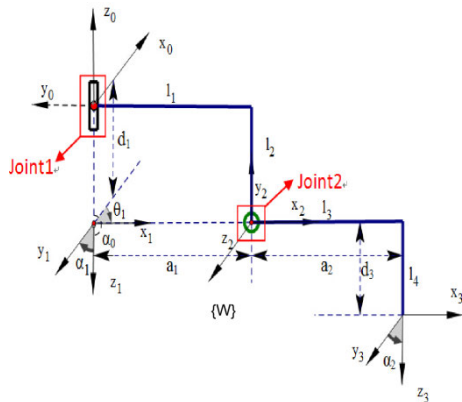

FIGURE 2. Spherical mobile robot driving leg coordinate system.

the driving leg, as shown in Fig. 2, and also obtain the pose matrix of the spherical mobile robot as shown in Equation 1, as shown at the bottom of this page.

The Jacobian matrix of the spherical mobile robot can be derived from the block matrix, as shown in Equation 2. And the relationship between velocity and the Jacobian matrix is shown in Equation 3. If the angular velocity is known, the angular velocity of the end effector can be determined.

The step optimal of the spherical mobile robot is adjusted according to the target position information and the collected information of the spherical mobile robot [15]. Based on the feedback X, Y, Z coordinate position, the relationship between the corresponding rotation angle, step size and evaluation function can be obtained.

$$J(\theta_1, \theta_2) = \begin{bmatrix} c_1c_2l_3 + c_1s_2l_4 + c_1l_1 & -s_1s_2l_3 + s_1c_2l_4 \\ s_1c_2l_3 + s_1s_2l_4 + s_1l_1 & c_1s_2l_3 - c_1c_2l_4 \\ 0 & c_2l_3 + s_2l_4 \end{bmatrix} \quad (2)$$

$$V = J\dot{\theta} \quad (3)$$

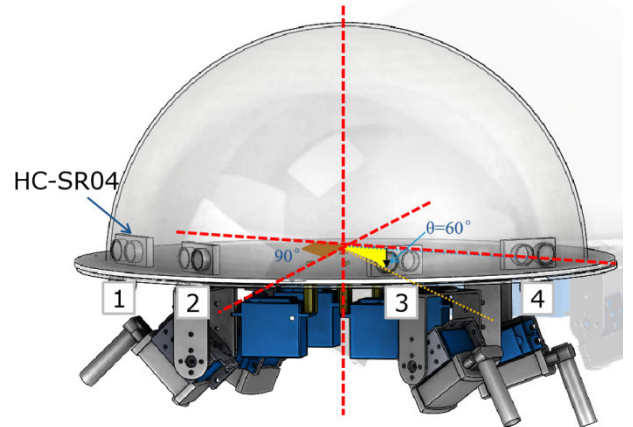

FIGURE 3. The arrangement of spherical mobile robot sensors(HC-SR04).

B. CONSTRAINT OF SPHERICAL MOBILE ROBOT EVALUATION FUNCTION

The evaluation function $U(v; \theta; d; q_{goal})$ uses the navigation evaluation function. Both the spherical mobile robot speed v and the end effector position are related to the step size, so this paper mainly optimize the robot step size S_a . The robot target state of the robot is $q_{goal} = [x_{goal}, y_{goal}, z_{goal}]^T$. The evaluation function is as shown in Equation 4.

$$U(v; \theta; d; q_{goal}) = U_{goal} + U_{vel} + U_{obs} \quad (4)$$

U_{goal} is the target position, which guides the spherical mobile robot to move. Consider convergence speed problem of the spherical mobile robot. This paper constrains the step size during the robot movement. When the robot approaches the target point, the robot step size S_a is reduced to ensure the stability of the motion. The relationship between U_{goal} and the step size S_a is shown in Equation 5.

$$U_{goal} = b_1 \text{sgn} \left[G(S_a) \cdot G(S_a)^2 + b_2 M(S_a)^2 \right]_t \quad (5)$$

U_{obs} is used to avoid obstacles in the movement of the spherical mobile robot, which ensures that robot can complete the optimal path without collision. When the robot approaches obstacles, the influence of the obstacle is close to infinity, such as shown in Equation 6.

$$U_{obs} = \begin{cases} b_2 \left(\frac{1}{\rho - \mu} - \frac{1}{\rho_0} \right)^2, & \text{if } \rho \leq \rho_0 \\ 0, & \text{if } \rho \geq \rho_0 \end{cases} \quad (6)$$

where μ is a small positive integer, ensuring that the robot has a certain distance from the obstacle, so that the influence of the obstacle is fixed within a certain range.

U_{vel} is used to limit the speed of the robot. When the distance is far from the target, the speed is selected greatly. When

$${}^0T_3 = {}^0T_1 T_2^1 T_3^2 T = \begin{bmatrix} c_1c_2c_3 - s_1s_3 & -c_1c_2s_3 - s_1c_2 & c_1s_2 & c_1c_2l_3 + c_1s_2l_4 + c_1l_1 \\ -s_1c_2c_3 + c_1s_3 & s_1c_2s_3 + c_1c_2 & -s_1s_2 & -s_1c_2l_3 - s_1s_2l_4 - s_1l_1 \\ s_2c_3 & -s_2s_3 & -c_2 & s_2l_3 - c_2l_4 - l_2 \\ 0 & 0 & 0 & 1 \end{bmatrix} \quad (1)$$

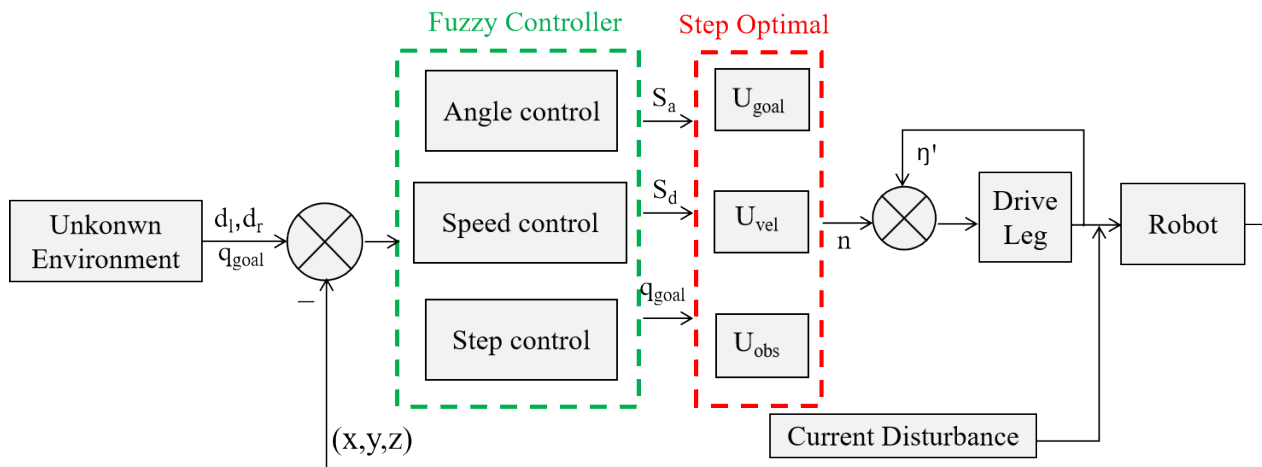

FIGURE 4. Fuzzy control scheme for the spherical robot.

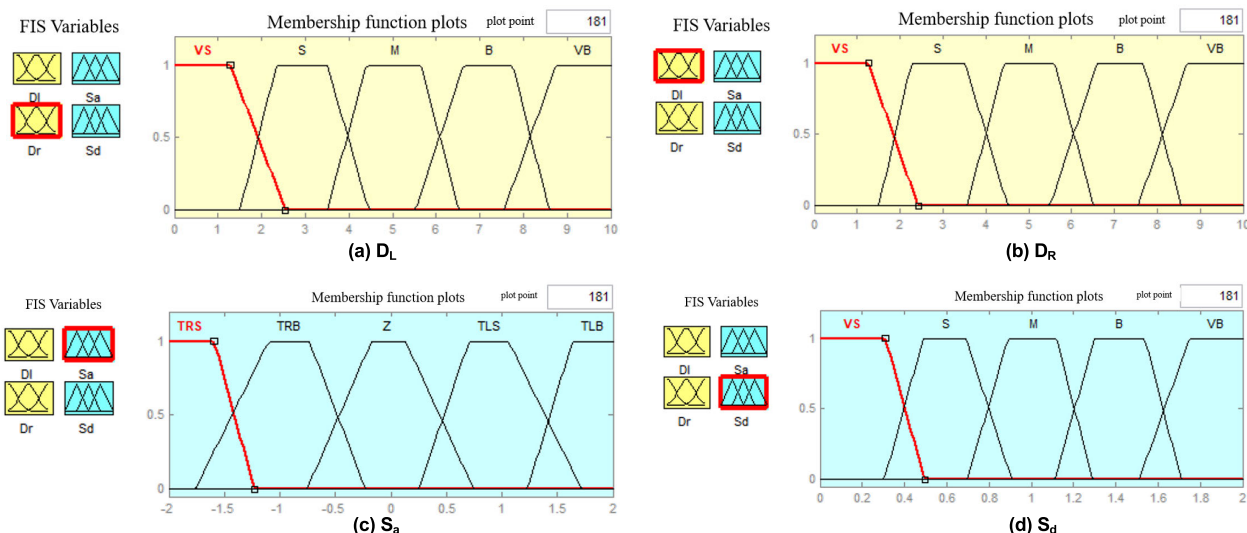

FIGURE 5. Membership function of input and output variables.

approaching the target point or obstacle, select a smaller speed to ensure the stability of the robot movement. As shown in Equation 7.

$$U_{vel} = \begin{cases} b_3(v - v_{max})^2, & \text{Far from the Target} \\ 0, & \text{Close to the Target} \end{cases} \quad (7)$$

C. MULTI-SENSOR FUSION STRATEGY

In this paper, ultrasonic sensors are used to detect unknown environmental information [16], [17]. In order to enhance the scanning range of ultrasonic sensors, this paper use four HC-SR04 ultrasonic sensors for detection. The sensor arrangement and scan range are shown in Fig. 3. The left and right sensors are symmetrical, and the angle between the left front sensor and the center line is 30°.

The four ultrasonic sensors are divided into two groups. And the input for each group is as follows: min(D_{L1}, D_{L2}) and min(D_{R1}, D_{R2}), where D_{L1} is the left side Distance, marked

by 1. D_{L2} is the left front distance, D_{R1} is the right front distance, and D_{R2} is the right distance.

III. DESIGN OF THE STEP OPTIMAL ALGORITHM BASED ON FUZZY THEORY

In order to complete the path planning of the spherical mobile robot, the step optimal algorithm based on fuzzy control is proposed. This paper uses fuzzy reasoning to construct a response table with good practical effects [18]. This paper establishes the anti-deadlock mechanism by fusing the distance information of multiple obstacles, which overcomes the deadlock problem in local path planning. The spherical mobile robot handles the danger zone as follows: The robot keeps a certain distance from the obstacle and walks along the edge of the obstacle, thus effectively avoiding the deadlock phenomenon.

The input variables of the fuzzy controller are D_L and D_R respectively, D_L represents the distance of the left obstacle,

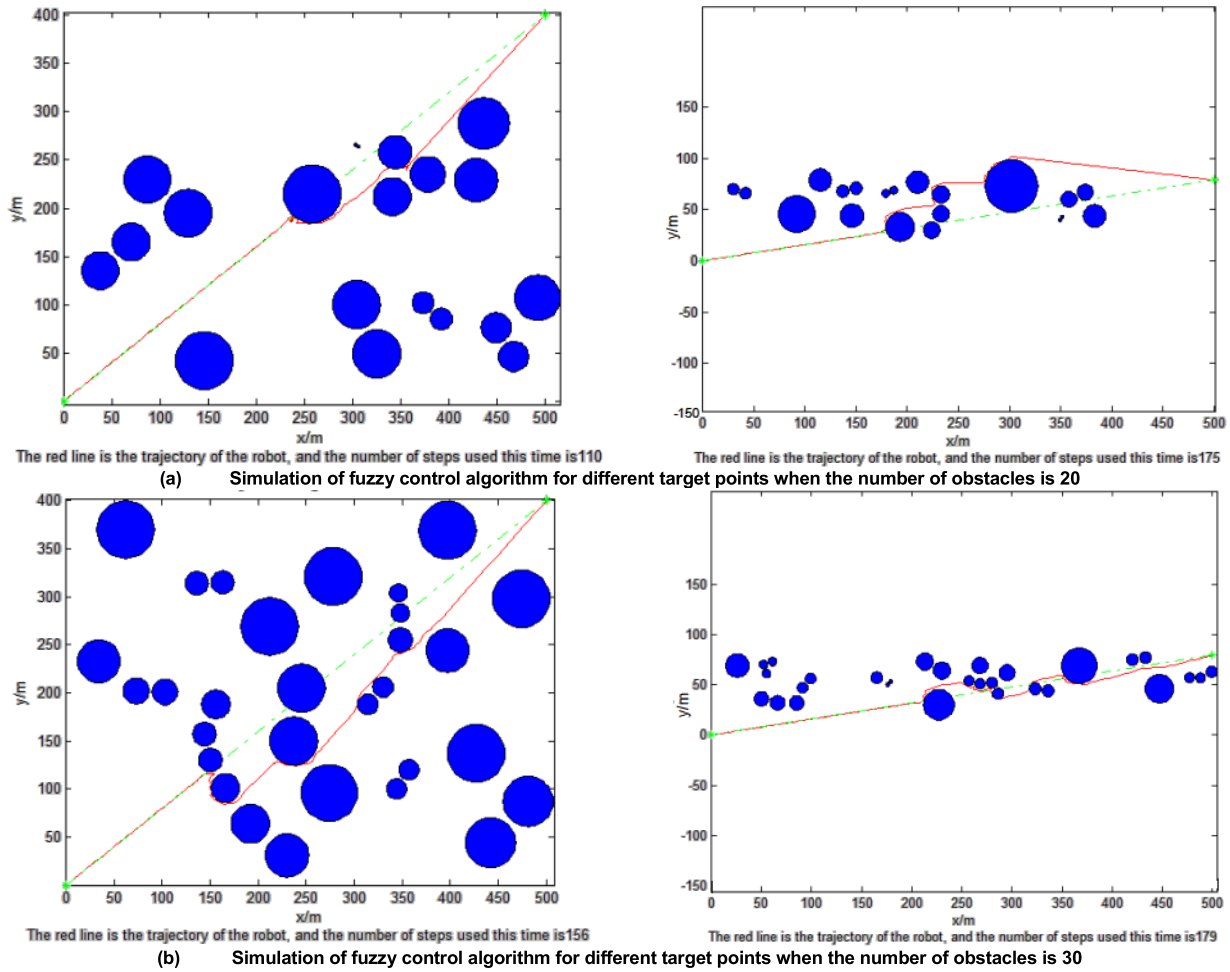

FIGURE 6. The simulation of step optimal path planning algorithm based on fuzzy control in unknown environment.

and the D_R represents the distance of the right obstacle; the output variables are the rotational angle scale factor S_a and the step size scale factor S_d . The design scheme of the fuzzy controller is shown in Fig. 4.

The obstacle distances D_L measured by the ultrasonic sensor are uniformly quantized into the interval of $[0, 8]$, and the domain is $[1, 3, 5, 7]$, and D_R set is the same as D_L . The fuzzy language variables are $D_L = \{VS, S, M, B, VB\}$, $D_R = \{VS, S, M, B, VB\}$, respectively. The output rotational angle scale factor S_a is uniformly quantized to the interval of $[-2, 2]$, and the domain is $[-1.5, -0.75, 0.75, 1.5]$, and its fuzzy language variables $S_a = \{TRS, TRB, Z, TLS, TLB\}$; The output step size scale factor S_d is uniformly quantized to the interval of $[0, 2]$, and the domain is $[0, 0.3, 0.6, 1, 1.4, 1.5, 1.8]$, and its fuzzy language variables $S_d = \{VS, S, M, B, VB\}$. The membership functions of each language variables are symmetric triangles. And the membership functions of D_L, D_R, S_a and S_d are shown in Fig. 5.

The basic idea of establishing the fuzzy rules is to ensure that the obstacle is avoided and as close as possible to the target. When the target point is located on the left side of the obstacle, the spherical mobile robot turns left. When the target

point is located on the right side of the obstacle, the robot turns right. The input distance of the left and right sides of the spherical mobile robot is the minimum value of the sensor detection distance [19], [20]. When the distance of the left obstacle is greater than the distance of the right obstacle, the robot turns left, so that the obstacle can be avoided safely, vice versa. The fuzzy rule table, as shown in Table 1, has 36 fuzzy rules.

Fuzzy reasoning uses the Mamdani reasoning method, and the clarity method uses the area centroid method. The step size scale factor S_d and the rotational angle scale factor S_a obtained by fuzzy reasoning are a kind of fuzzy quantity, which needs to be converted into an accurate quantity, and the following Equation 8 is used for clarity:

$$Z_0 = \frac{\int z \cdot \mu_N(z) dz}{\int \mu_N(z) dz} \tag{8}$$

In the formula, “ \int ” represents the algebraic integral of all membership values on the continuous domain, and $\mu_N(z)$ represents the membership function of the left and right obstacle distances, and z represents the center of gravity of the area

TABLE 1. The fuzzy rule between the input variable and the output variable.

S_d	EC					
	VS	S	M	B	VB	
VS	VS	VS	S	S	M	
S	VS	VS	S	S	M	
E	M	S	S	M	M	B
	B	M	M	B	B	VB
VB	M	M	B	B	VB	

corresponding to the output variables S_a and S_d membership function.

A. SIMULATION EXPERIMENTS IN UNKNOWN ENVIRONMENT

Due to the limited detection range of the sensor and the surrounding uncertainty, this paper use the fuzzy control method to study path planning of the spherical robot [21].

This paper use Matlab to complete the simulation experiments under unknown environment. The main purpose of experiments are to verify whether the fuzzy control method can complete the path planning from the starting point to the target point in random environments, and whether the path can satisfy the optimality [10], [22].

This paper also use Matlab to build simulation models, including the fuzzy controller, the spherical robot motion model, and the ultrasonic sensor model, etc. Simulation experiments are carried out in a circular obstacle environment with different radius.

In the simulation process, this paper set the starting point to be the same, and the position of the end point can be set arbitrarily. The validity and reliability of the control method this paper proposed is verified by changing the number of obstacles and the position of the end point. As shown in Fig. 6 (a), the number of obstacles is set to 20, according to the difference of the end point, the robot can safely reach the target point from the starting point and avoid the deadlock phenomenon; As shown in Fig. 6 (b), the number of obstacles is set to 30, and the effectiveness of the method is further verified by changing the position of the target point. The experimental results showed that the spherical mobile robot can successfully find a collision-free path from the starting point to the target point in the dense and unknown environment, and the path planning effect is ideal.

B. SIMULATION EXPERIMENTS OF SPHERICAL MOBILE ROBOT MOTION STATE

The last section verifies the validity of fuzzy control method in unknown environment. In order to further verify whether

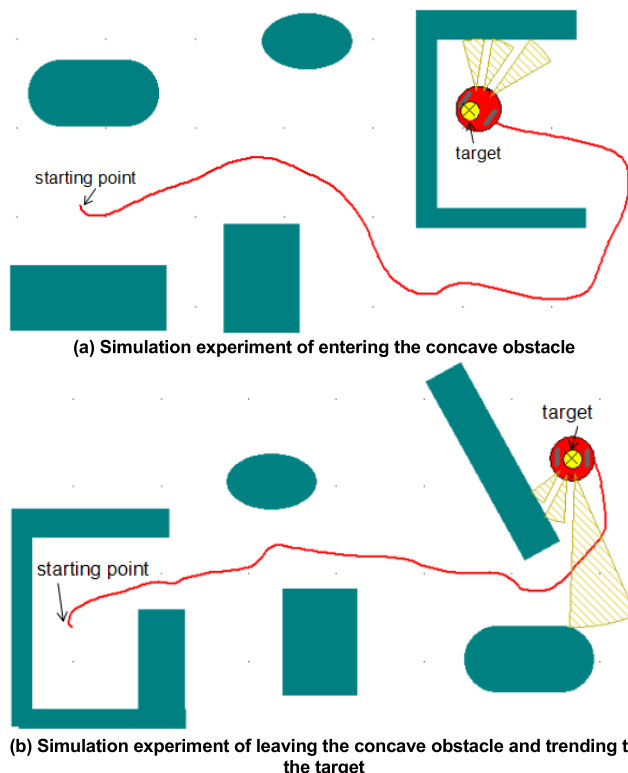

FIGURE 7. The experiment of anti-deadlock and trending to the target.

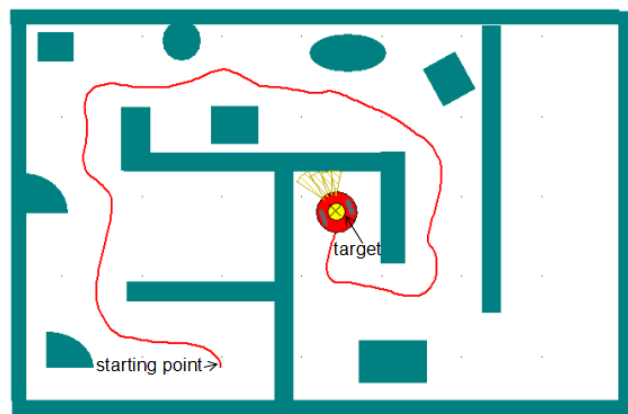

FIGURE 8. The simulation experiment of avoiding obstacles in complex environment.

the fuzzy control method exists deadlock phenomenon and whether the robot can avoid moving obstacles. This paper also use the Mobsim platform to carry out the anti-deadlock experiments, obstacle avoidance experiments in complex environment, and obstacle avoidance experiments in dynamic environment.

In the Mobsim simulation platform, this paper set the number of sensors, the detection range, and the arrangement position to be the same as the spherical robot. In the arbitrarily changed 2-dimensional complex environment, it can effectively simulate the behavior of obstacle avoidance and trending toward the target. The robot can obtain the external

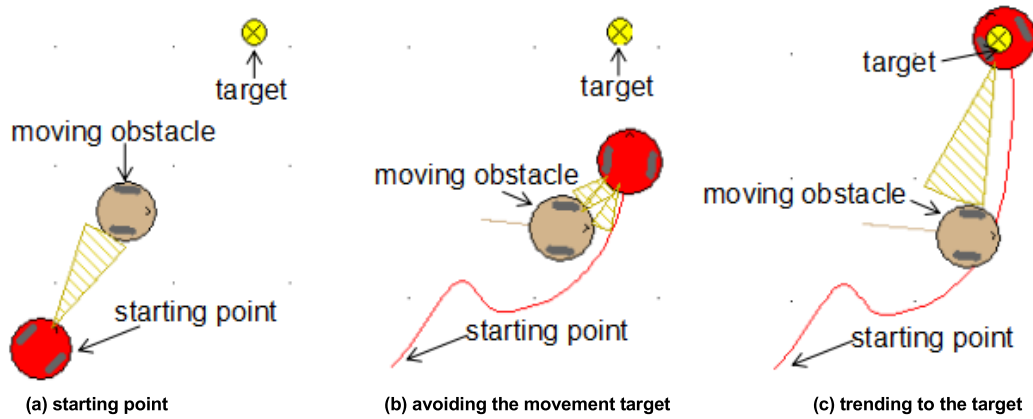

FIGURE 9. Simulation experiment of obstacle avoidance of single motion obstacle.

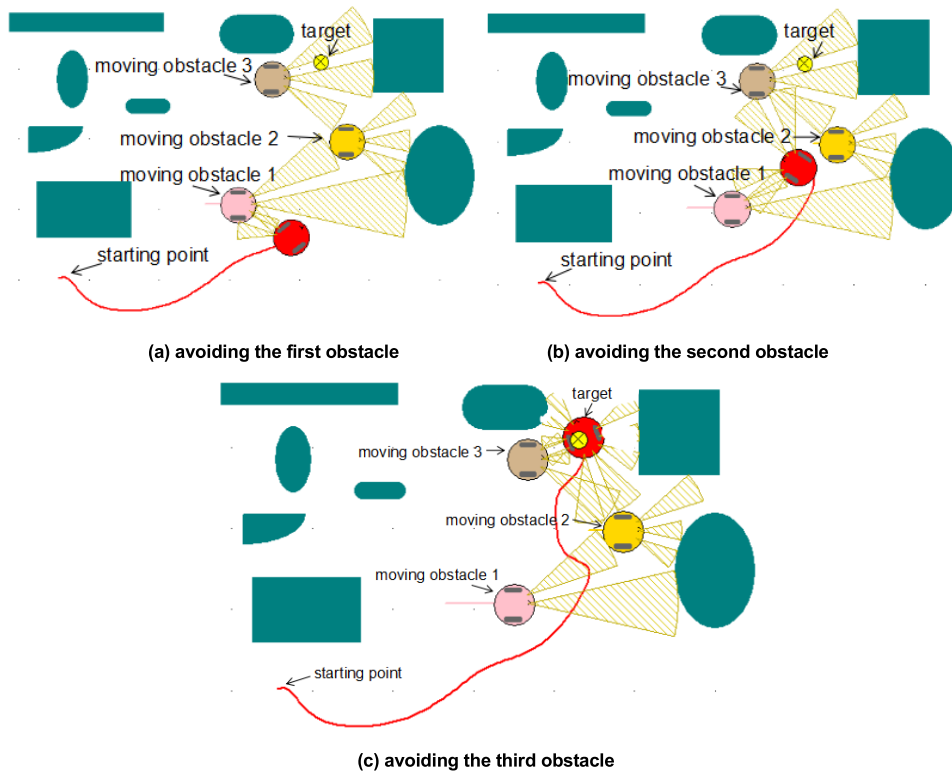

FIGURE 10. Simulation experiment of avoiding multi motion obstacles.

environment information and the current position coordinates of the spherical robot, so that the robot can safely reach the target point. The shadow part represents the sensing range of each sensor, the yellow circle represents the target point, and dark green represents obstacles which can be constructed in different shapes. After completing the setting of specific parameters, a series of experiments are completed, including the experiments of anti-deadlock, the experiments of trending target, the experiments of complex obstacle environment and the experiments of dynamic environment.

1) THE EXPERIMENT OF ANTI-DEADLOCK AND TRENDING TO THE TARGET

In the simulation experiment, two groups of experiments are designed, which were mainly composed of target points, concave obstacles and other obstacles. The number of sensors on the robot is set to 4, and the detection distance and angle of the sensors are also set. The first group of experiments is the trending to the target experiment, which successfully solves the problem that the robot can't enter the concave obstacles. As shown in Fig. 7 (a), when the target is located inside the concave obstacle, the robot can

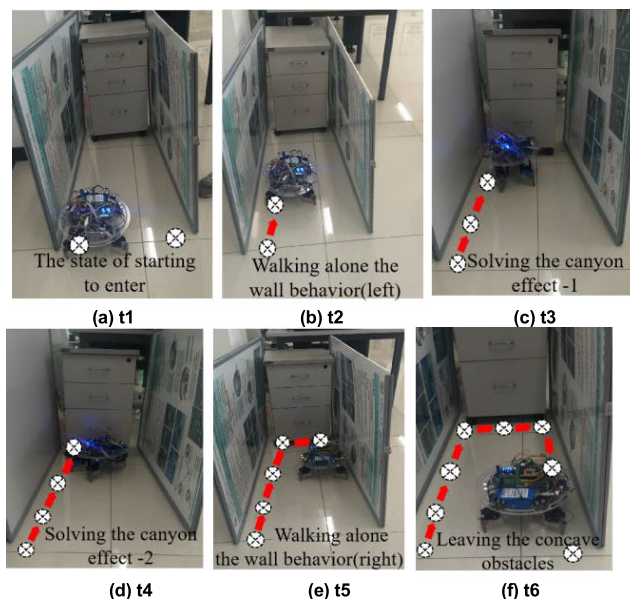

FIGURE 11. The experimental result of the spherical robot in concave obstacles.

safely reach the target point; The second group of experiments is mainly to solve the deadlock phenomenon. The robot is placed inside the concave obstacle, and the target point is placed behind the obstacle, the robot can leave the concave obstacle safely and avoid the other obstacles to reach the target point successfully, and effectively solve the problem of deadlock, as shown in Fig. 7 (b). The red line represents the trajectory of the robot. From the trajectory, it can be seen from the trajectory that the robot can effectively avoid deadlock phenomenon and reach the target point safely, which further confirms the reliability of the fuzzy control method.

2) THE EXPERIMENTS OF OBSTACLE AVOIDANCE IN COMPLEX ENVIRONMENT

Then, this paper carry out experiments in complex environments, as shown in Fig. 8. Then, this paper design path planning experiments in complex environment. These experiments are mainly to verify the ability of the robot to avoid obstacles. Some irregular shapes are set in the experiment and the walking along the wall behavior is written into the program. The simulation results show that the robot can effectively avoid obstacles in complex environment, smooth motion path and less jitter, which indicates that the fuzzy control method can meet the needs of the spherical mobile robot in complex environment.

3) THE EXPERIMENT OF OBSTACLE AVOIDANCE UNDER MOVING OBSTACLES

In the real environment, most obstacles are irregular and moving. So it is necessary to verify the obstacle avoidance ability of the spherical mobile robot under moving obstacles. In the simulation experiment, two groups of experiments are designed. In the first group of experiments, this paper carry

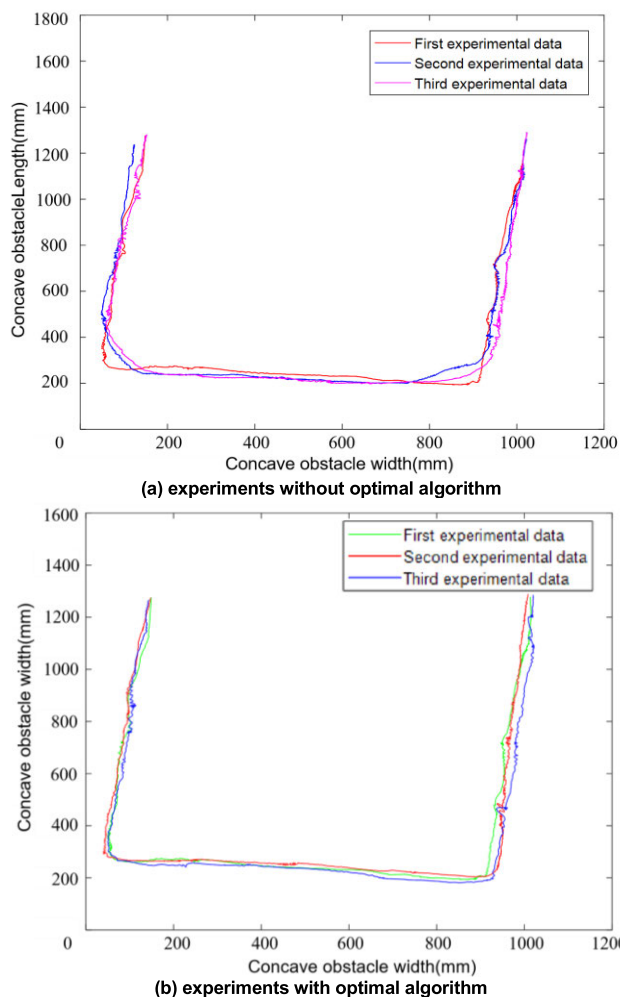

FIGURE 12. Path planning for the spherical mobile robot in the concave environment.

out experiments in a single moving obstacle environment, as shown in Fig. 9. It can be seen that the robot leaves from the starting position in Fig. 9 (a), and when moving obstacle is detected in Fig. 9 (b), the robot can safely bypass the obstacle, and move to the target position again in Fig. 9 (c). In the second group of experiments, some obstacles were irregular. The three obstacles were moving in a straight line at a certain speed, as shown in Fig. 10 (a), when the first moving obstacle was detected by the spherical mobile robot, the robot turn right; In Fig. 10 (b), when the second moving obstacle was detected by the robot, the robot turn left; In Fig. 10 (c), when the third moving obstacle was detected by the robot, the robot turn right and reached the target point safely. The simulation results verified the feasibility and effectiveness of the fuzzy control method.

IV. EXPERIMENTAL RESULTS

The simulation experiment effectively verifies the stability and reliability of the robot in unknown environment. Next, this paper use the spherical mobile robot we designed to complete a series of simulation-related path planning



FIGURE 13. Experiments of obstacle avoidance for the spherical robot in complex environment.

experiments, including path planning experiments in the concave environment, path planning experiments in the complex environment, and path planning experiments in the moving environment. After many experiments and error analysis, the experimental results further verified that the proposed algorithm could improve the autonomous motion ability of the spherical mobile robot in unknown environment.

A. PATH PLANNING EXPERIMENTS IN THE CONCAVE ENVIRONMENT

In the process of robot motion, this paper uses NDI system to measure the data. First, the NDI system is debugged to ensure that the robot’s motion trajectory is measurable. Then, after the commissioning is completed, the NDI system is fixed to ensure that the environment is the same for each experiment.

The concave obstacle is an effective experiment to verify that the robot does not have canyon effect. This paper carries out experiment of concave obstacle in real environment, as shown in Fig. 11. In Fig. 11(a), the spherical robot is about to enter the concave obstacle; In Fig. 11(b)-(e), the spherical

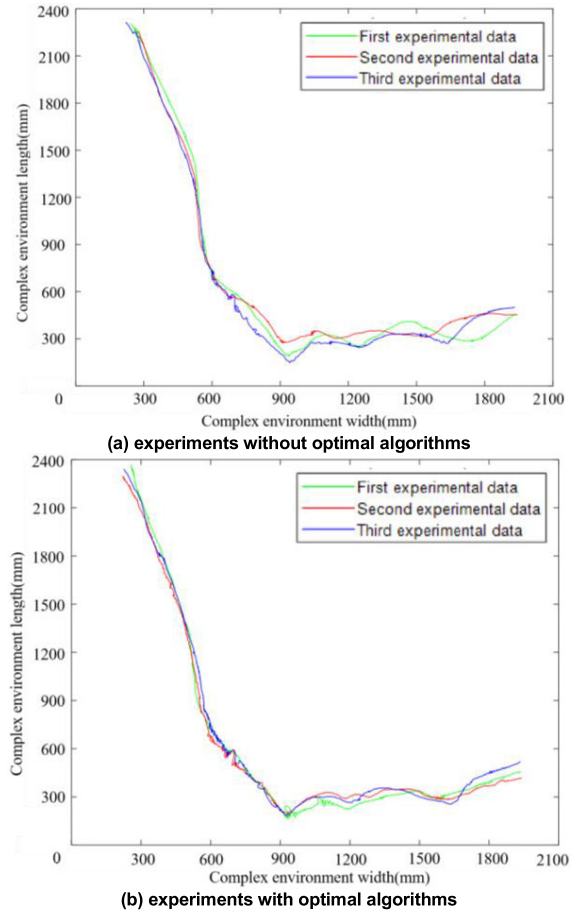

FIGURE 14. Path planning for spherical mobile robots in the complex environment.

robot enters the concave obstacle. At this time, according to the fuzzy obstacle avoidance rule, the robot always thinks there are obstacles on one side, so switch to walking along the wall behavior. In Fig. 11(f), the spherical mobile robot leaves the concave obstacle, and avoid the concave obstacles successfully.

The concave environment has a length of 1000 mm and a width of 900 mm. The trajectory of the spherical mobile robot is shown in Fig. 12. Before the step size optimization algorithm is used, the trajectory of the robot is shown in Fig. 12(a). After the optimization algorithm is used, the trajectory of the robot is shown in Fig. 12(b). It can be seen from the optimized trajectory that the robot is more sensitive to obstacles, the motion is more stable, and the trajectory is more ideal. Especially when turning, the robot motion error is significantly optimized.

B. PATH PLANNING EXPERIMENTS IN THE COMPLEX ENVIRONMENT

In order to verify the effectiveness and stability of the spherical mobile robot in the complex environment, this paper set the robot starting position as shown in Fig. 13(a). In the complex environment, the robot’s motion behavior is mainly achieved by changing the step size, as shown in Fig. 13.

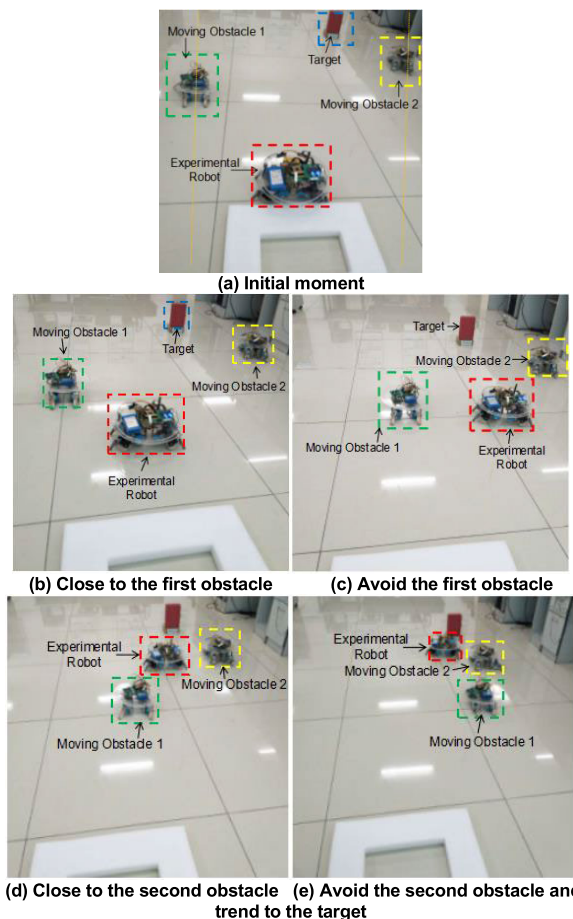
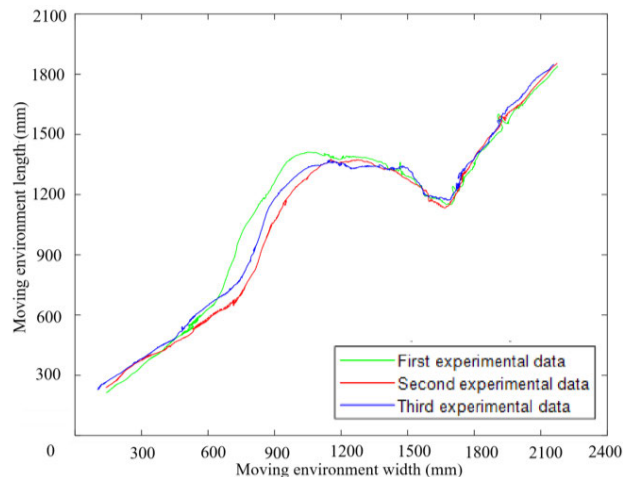

FIGURE 15. Experimental process to avoid movement obstacles.

When the robot detects no obstacles, it tends to dominate the target behavior. When the obstacle is detected, the obstacle avoidance behavior of the robot is dominant.

Switching between various behaviors is achieved by priority calling, until the target position is reached. In Fig. 13 (b) the spherical robot was in the cruising state; In Fig. 13(c), the spherical robot was switched to the obstacle avoidance behavior, avoiding the first obstacle; In Fig. 13(d), the spherical robot was switched to the walking along the wall behavior and passed through the narrow road smoothly. In Fig. 13 (e)-(f), the spherical robot was switched to the obstacle avoidance behavior and avoiding two obstacles continuously. In Fig. 13 (g)-(h), the spherical robot switched to the trending to the target behavior. Finally, the spherical robot reached the target point successfully and completed the path planning.

The trajectory of the robot is shown in Fig. 14. The complex environment has a length of 2100 mm and a width of 1700 mm. Fig. 14(a) shows that the robot does not use the optimized step algorithm, and Fig. 14(b) shows that the robot uses the optimized step algorithm. The spherical mobile robot has large jitters when encountering obstacles and turning, and the movement is unstable. It can be seen that the optimization algorithm can improve the stability and obstacle avoidance of the spherical mobile robot.



(a) experiments without optimal algorithms

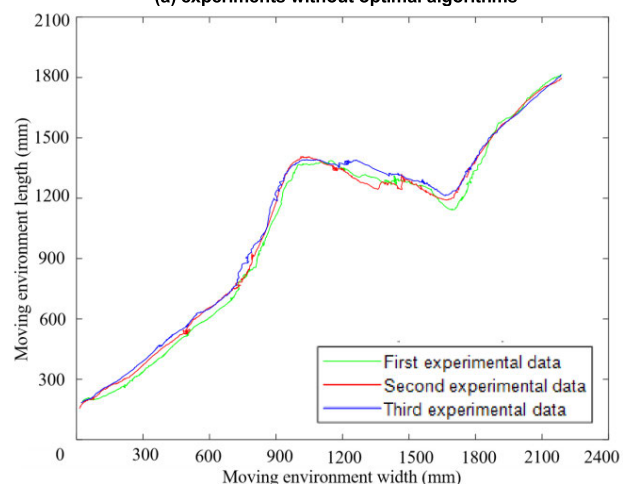

(b) experiments with optimal algorithms

FIGURE 16. Path planning for spherical mobile robots in the moving environment.

C. PATH PLANNING EXPERIMENTS IN THE MOVING ENVIRONMENT

Since most obstacles are irregular or moving, this paper designed the obstacle avoidance experiments for the spherical mobile robot under moving obstacles. As shown in Fig. 15 (a), the robot in the green box represents the first obstacle, the robot in the yellow box represents the second obstacle, and the robot in the red box represents the master robot in the experiment. The target position used in this experiment is marked. The speed of the experimental robot is 7.6 cm/s, the speed of releasing the first obstacle is 5.5 cm/s, and the obstacle moves in a straight line. The experiment of avoiding the first obstacle is shown in Fig. 15 (b) - (c). When the first obstacle is avoided, the second obstacle will be released at a speed of 3.6 cm/s. The second obstacle will also move along a straight line. When the first obstacle is avoided, it will move toward the target. The avoidance process is shown in Fig. 15 (d) - (e).

The trajectory of the spherical mobile robot is shown in Fig. 16. The moving environment has a length of 1600 mm and a width of 2100 mm. It can be seen that when the spherical

TABLE 2. Experimental parameters in different environments.

Experiment	Algorithm	Starting point (mm)	Target point (mm)	Sampling time(s)	Average time(s)
The concave environment	Without fuzzy control	(150, 1300)	(1000, 1300)	65	55.6
	Using fuzzy control				41.2
The complex environment	Without fuzzy control	(2380, 280)	(380, 1980)	80	68.4
	Using fuzzy control				53.5
The moving environment	Without fuzzy control	(50, 200)	(2200, 1850)	80	65.7
	Using fuzzy control				50.3

mobile robot encounters moving obstacles, the robot response is more sensitive, and the error of multiple measurement results is significantly reduced, which increases the stability of robot's motion. In particular, the stability of the robot has been greatly improved. This provides a guarantee for the movement of spherical mobile robot in unknown environment.

V. DISCUSSION

When spherical mobile robot move in the unknown environment, the stability and sensitivity of robotic motion are most important for autonomous navigation and path planning. It can be seen from the experiments before and after the optimization algorithm that the optimized algorithm can improve the stability of the robot motion.

From the motion trajectories of the three sets of experiments, it can be seen that the step optimization algorithm based on fuzzy control can improve the stability of the robot motion and reduce the error, which is closer to the ideal path. The optimization algorithm can show good self-regulating performance when encountering obstacles and turning. And adjust the appropriate step size to guide the robot to the reference point (target) in the planned path.

This paper uses the NDI system to collect the spherical mobile robot data. Since the NDI measurement range is limited and the maximum measurement range is within 3.5 meters, the measurement experiment environment is limited. To more clearly verify the performance of the optimization algorithm, this paper calculated the average time for each set of experiments, as shown in Table 2.

It can be seen from Table 2 that after the optimization algorithm is used, the time for the robot to reach the target position has changed significantly, shortening by about 15s.

The step size optimization algorithm proposed in this paper improves the flexibility of robot motion. The time for the

robot to reach the target position is significantly optimized, and the motion trajectory is smoother, which improves the working efficiency of the robot in an unknown environment.

VI. CONCLUSION AND FUTURE WORK

To improve the ability of spherical mobile robot to navigate and move autonomously in an unknown environment, this paper proposed the step optimal path planning method based on fuzzy control. The evaluation function was used to improve the robot's autonomous movement ability. To verify the effectiveness and practicability of the proposed method, a series of simulations and experiments were also completed, including the path planning experiments in the concave environment, the path planning experiments in the complex environment and the path planning experiments in the dynamic environment. The results showed that the spherical mobile robot could successfully complete the path planning. In particular, the stability and sensitivity of the spherical mobile robot motions' was improved, which was very important for path planning experiments in an unknown environment.

This paper get some conclusions:

- 1) The evaluation function could improve the autonomous motion of the spherical mobile robot in the unknown environment.
- 2) The motion stability had a great impact on path planning experiments of the spherical mobile robot.
- 3) The step optimal method made the spherical mobile robot more sensitive to obstacles and improved the execution efficiency of the robot.

In the future, this paper will apply the proposed control algorithm to multi-robot collaboration to improve the execution efficiency of multiple spherical mobile robots in unknown environment.

REFERENCES

- [1] Z. Xian, X. He, and J. Lian, "A bionic autonomous navigation system by using polarization navigation sensor and stereo camera," *Auto. Robots*, vol. 41, no. 5, pp. 1107–1118, 2017.
- [2] Y. Li, S. Li, and A. Zhang, "Research status of autonomous & remotely operated vehicle," *J. Eng. Stud.*, vol. 8, no. 2, pp. 217–222, 2016.
- [3] *Rolling Surveillance Robot from the Future*. Accessed: 2011. [Online]. Available: <http://www.rotundus.se/specifications.html>
- [4] *Spherical Robot-GroundBot*. Accessed: 2009. [Online]. Available: <http://jandan.net/2009/05/25/groundbot.html>
- [5] S. Guo, Y. He, and L. Shi, "Modeling and experimental evaluation of an improved amphibious robot with compact structure," *Robot. Comput. Integr. Manuf.*, vol. 51, pp. 37–52, Jun. 2018.
- [6] Y. Girdhar and G. Dudek, "Modeling curiosity in a mobile robot for long-term autonomous exploration and monitoring," *Auto. Robots*, vol. 40, pp. 1–12, Sep. 2015.
- [7] A. J. Mckay and C. J. Johnson, "Identifying effective and sustainable measures for community-based environmental monitoring," *Environ. Manage.*, vol. 60, no. 3, pp. 1–12, 2017.
- [8] S. Guo, Y. He, and L. Shi, "Modal and fatigue analysis of critical components of an amphibious spherical robot," *Microsyst. Technol.*, vol. 23, no. 6, pp. 1–15, 2016.
- [9] J. Guo, S. Guo, and L. Li, "Design and characteristic evaluation of a novel amphibious spherical robot," *Microsyst. Technol.*, vol. 23, no. 6, pp. 1999–2012, 2017.

- [10] A. M. Pinto, E. Moreira, and P. Costa, "A cable-driven robot for architectural constructions: A visual-guided approach for motion control and path-planning," *Auto. Robots*, vol. 41, no. 7, pp. 1–13, 2017.
- [11] Y. Rasekhipour, A. Khajepour, S.-K. Chen, and B. Litkouhi, "A potential field-based model predictive path-planning controller for autonomous road vehicles," *IEEE Trans. Intell. Transp. Syst.*, vol. 18, no. 5, pp. 1255–1267, May 2017.
- [12] N. Chao, Y. K. Liu, and H. Xia, "Grid-based RRT*, for minimum dose walking path-planning in complex radioactive environments," *Ann. Nucl. Energy*, vol. 115, pp. 73–82, May 2018.
- [13] R. Logambigai and A. Kannan, "Fuzzy logic based unequal clustering for wireless sensor networks," *Wireless Netw.*, vol. 22, no. 3, pp. 945–957, Apr. 2016.
- [14] A. Yazici, G. Kirlik, O. Parlaktuna, and A. Sipahioğlu, "A dynamic path planning approach for multirobot sensor-based coverage considering energy constraints," *IEEE Trans. Cybern.*, vol. 44, no. 3, pp. 305–314, Mar. 2013.
- [15] M. Roozegar, M. J. Mahjoob, and M. Jahromi, "Optimal motion planning and control of a nonholonomic spherical robot using dynamic programming approach: Simulation and experimental results," *Mechatronics*, vol. 39, pp. 174–184, Nov. 2016.
- [16] A. Verger, F. Baret, and M. Weiss, "A multisensor fusion approach to improve LAI time series," *Remote Sens. Environ.*, vol. 115, no. 10, pp. 2460–2470, 2011.
- [17] J. Ha, D. Kang, and F. C. Park, "A stochastic global optimization algorithm for the two-frame sensor calibration problem," *IEEE Trans. Ind. Electron.*, vol. 63, no. 4, pp. 2434–2446, Apr. 2016.
- [18] A. Bakdi, A. Hentout, and H. Boutami, "Optimal path planning and execution for mobile robots using genetic algorithm and adaptive fuzzy-logic control," *Robot. Auto. Syst.*, vol. 89, no. 1, pp. 95–109, 2016.
- [19] C. Le and L. Zhenghua, "Design of two-stage fuzzy controller for mobile robot using vision navigation," in *Proc. IEEE Chin. Guid., Navigat. Control Conf. (CGNCC)*, Aug. 2016, pp. 872–877.
- [20] K. S. Tang, K. F. Man, G. Chen, and S. Kwong, "An optimal fuzzy PID controller," *IEEE Trans. Ind. Electron.*, vol. 48, no. 4, pp. 757–765, Aug. 2001.
- [21] B. Sun, D. Zhu, and S. X. Yang, "An optimized fuzzy control algorithm for three-dimensional AUV path planning," *Int. J. Fuzzy Syst.*, vol. 20, no. 2, pp. 1–14, 2018.
- [22] B. Ding, G. Wen, X. Huang, C. Ma, and X. Yang, "Target recognition in SAR images by exploiting the azimuth sensitivity," *Remote Sens. Lett.*, vol. 8, no. 9, pp. 821–830, 2016.



JIAN GUO (M'76–SM'81–F'87) received the B.S. degree in information and computing science from the Changchun University of Technology, China, in 2005, and the M.S. and Ph.D. degrees in intelligent machine system from Kagawa University, Japan, in 2009 and 2012, respectively.

He is currently a Professor with the Tianjin University of Technology, China. He has published about 40 refereed journal and conference papers in the recent three years. He researches on spherical amphibious robots and biomedical robots.

Prof. Guo has received the Best Conference Paper Award of CME 2013 and the IEEE ICIA 2014.



CHUNYING LI received the B.S. degree in automation from the Tianjin University of Technology, Tianjin, China, in 2017, where he is currently pursuing the M.S. degree in control science and engineering. He is currently a Postgraduate Researcher in control science and engineering with the Tianjin University of Technology. He researches on path planning method for the spherical robot, such as the spherical robot for military and resource detection applications. He has

published two conference papers in the past year. His current research interests include the spherical robot that avoids the moving obstacles and the tele-operation control systems.



SHUXIANG GUO (S'93–M'95–SM'03) received the B.S. and M.S. degrees in mechanical engineering from the Changchun Institute of Optics and Fine Mechanics, Changchun, China, in 1983 and 1986, respectively, and the Ph.D. degree in mechano-informatics and systems from Nagoya University, Nagoya, Japan, in 1995.

In 1995, he was a Faculty Member with Mie University, Mie, Japan, and Kagawa University, Kagawa, Japan, in 1998. He is currently a Professor with the Department of Intelligent Mechanical System Engineering, Kagawa University, with the Tianjin Key Laboratory for Intelligent Robot Laboratory, Tianjin University of Technology, and also with The Institute of Advanced Biomedical Engineering System, Beijing Institute of Technology.

He has published about 400 refereed journal and conference papers. His current research interests include microrobotics and mechatronics, microrobotics systems for minimal invasive surgery, micro catheter systems, micro pump, and smart material (SMA and ICPF) based on actuators.

Dr. Guo has received research awards from the Tokai Section of the Japan Society of Mechanical Engineers (JSME), in 1997, and the Tokai Science and Technology Foundation, in 1998, the Best Paper Award of the IS International Conference, in 2000, the Best Paper Award of the 2003 International Conference on Control Science and Technology, and the Best Conference Paper Award of IEEE ROBIO 2004, IEEE ICAL 2008 and IEEE ICIA 2011, IEEE ROBIO 2013, IEEE ICIA 2014. He also received the Chang Jiang Professorship Award from the Ministry of Education of China, in 2005, and was offered Thousand-Elite-Project in China. He is also the Founding Chair of the IEEE International Conference on Mechatronics and Automation. He is also the Editor-in-Chief of the *International Journal of Mechatronics and Automation*.

• • •