

Received November 20, 2019, accepted December 1, 2019, date of publication December 16, 2019, date of current version December 23, 2019.

Digital Object Identifier 10.1109/ACCESS.2019.2959949

Wireless Sensor Network Deployment Optimization Based on Two Flower Pollination Algorithms

ZHENDONG WANG¹, HUAMAO XIE¹, DAOJING HE², (Member, IEEE),
AND SAMMY CHAN³, (Member, IEEE)

¹School of Information Engineering, Jiangxi University of Science and Technology, Ganzhou 341000, China

²School of Software Engineering, East China Normal University, Shanghai 200062, China

³Department of Electrical Engineering, City University of Hong Kong, Hong Kong

Corresponding author: Huamao Xie (fhzm1995@163.com)

This work was supported in part by the National Natural Science Foundation of China under Grant 61562037, Grant 61562038, Grant 61563019, Grant 61763017, Grant U1936120, and Grant U1636216, in part by the National Key Research and Development Program of China under Grant 2017YFB0802805 and Grant 2017YFB0801701, in part by the Natural Science Foundation of Jiangxi Province under Grant 20171BAB202026 and Grant 20181BBE58018, in part by the Science and Technology Project Founded by the Education Department of Jiangxi Province under Grant GJJ150643, and in part by the Innovation Designated Fund for Graduate Student of Jiangxi Province under Grant YC2018-S331.

ABSTRACT For the wireless sensor networks (WSNs) heterogeneous node deployment optimization problem with obstacles in the monitoring area, two new flower pollination algorithms (FPA) are proposed to deploy the network. Firstly, an improved flower pollination algorithm (IFPA) is proposed based on FPA, aiming at the shortcomings of the convergence speed is slow and the precision is not high enough of FPA. The nonlinear convergence factor is designed to correct the scaling factor of FPA, the Tent chaotic map effectively maintains the diversity of the population in the late iteration, and a greedy crossover strategy is designed to assist the remaining individual search with better individuals. Secondly, based on FPA, a non-dominated sorting multi-objective flower pollination algorithm (NSMOFPA) is proposed. The external archive strategy and leader strategy are introduced, to solve the global pollination problem. The proposed crowding degree method and the introduced elite strategy effectively maintain the diversity of the population. Then, IFPA is applied to WSN deployment aiming at optimizing coverage rate, simulation experiments show that IFPA can obtain a higher coverage rate with shorter iterations, which can save network deployment costs. Finally, applying NSMOFPA to the WSN deployment with optimization objectives for coverage rate, node radiation overflow rate and energy consumption rate. The experimental results verify that NSMOFPA has a good optimization effect and can provide a better solution for WSN deployment.

INDEX TERMS Deployment optimization, improved flower pollination algorithm, non-dominated sorting, multi-objective flower pollination algorithm, wireless sensor networks.

I. INTRODUCTION

With the development of 5G and the Internet of Things, wireless sensor networks (WSNs) have been widely used in medical health, environmental monitoring and industrial fields [1]–[3]. In recent years, researchers have studied the routing protocols, positioning and coverage in WSNs [4]–[6], where coverage optimization is one of the most basic problems of WSNs [7]. Regional coverage optimization is a

The associate editor coordinating the review of this manuscript and approving it for publication was Ghufuran Ahmed^{id}.

research hotspot that researchers are very interested in, but the intricate real-world environment brings new challenges to WSN deployment. In the meantime, group intelligence algorithms have been widely used in optimization problems, network deployment mostly uses intelligent optimization algorithms to implement dynamic deployment of nodes on a two-dimensional plane.

There are two circumstances: urban deployment and forest deployment. As shown in Fig. 1, the sensors are deployed in urban residential areas, nodes can be charged by solar energy, and coverage is the optimization objective of network

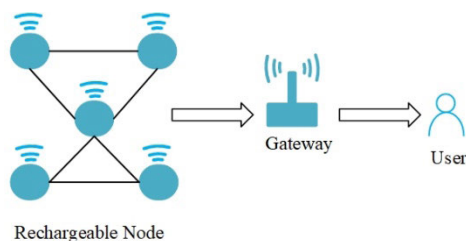

FIGURE 1. WSN deployed in urban area.

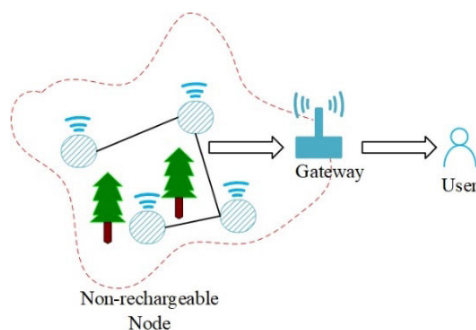

FIGURE 2. WSN deployed in forest.

deployment. In this circumstance, most researchers have discussed the deployment of homogeneous sensor nodes in obstacle-free monitoring areas, and they considered the entire monitoring area to be fully covered with a minimum number of nodes [8]–[12]. Fig. 2 shows the second circumstance in which the sensor network is deployed in the forest and the batteries of nodes are not rechargeable. In this case, the optimization of energy consumption is very important to the life span of the whole network. Most researchers have studied the deployment problem with network coverage rate, energy consumption rate, deployment cost, network connectivity and energy consumption balance rate, and most of them considered the deployment of homogeneous sensor nodes in the obstacle-free monitoring area [13]–[17]. The multi-objective coverage optimization problem is finally optimized using multi-objective optimization algorithms. The flower pollination algorithm (FPA) is a heuristic search algorithm proposed by Yang [18], and has been applied to flexible job shop scheduling, Sudoku problem and economic dispatch [19]–[21], but FPA has the disadvantages of slow convergence rate and low optimization precision. Multi-objective flower pollination algorithm mostly optimizes multi-objective problems in a linear weighted sum manner [22]–[24], however, the linear weighted sum optimization method cannot optimize all multi-objective optimization problems.

For the first deployment circumstance, taking into account the actual deployment environment, this paper studies the problem of maximizing network coverage, with the presence of obstacles in the monitoring area and the deployment of mixed sensor nodes with multiple perceived radii. On the basis of FPA, we propose an improved flower pollination

algorithm (IFPA) to effectively improve node coverage in network deployment. The main improvements are as follows.

- 1) The chaotic map is used to initialize the population and enrich the diversity of the population. When the algorithm falls into local optimum, the chaotic mapping method is utilized to generate some new search agents. Hence, the strategy enhances the ability of the algorithm to jump out of local optimum.
- 2) A nonlinear convergence factor is proposed to constrain the original scaling factor, this strategy improves the convergence ability of the algorithm by promoting global optimization search.
- 3) The proposed greedy crossover strategy optimizes the search with the current individual, surrounding individuals and optimal individuals, and effectively improving the precision of solution.

For the second deployment circumstance, in [10], a model of node radiation overflow rate was proposed, but it only discusses the area of the node radiation overflow. Reference [12] proposed a network model with network coverage and energy consumption, but only considered a part of energy consumption. In recent years, even if FPA is used to solve multi-objective optimization problems, most of them are converted into single-objective optimization by linear weighted sum. Several distinctive contributions of this paper are summarized as follows.

- 1) This paper adds the discussion of the node radiation overflow area in the case of obstacles. If the area of the overflow is less, the network is more stable and conducive to secondary deployment.
- 2) The energy consumption of this paper consists of the perceived consumption, the energy consumed to receive and transmit data, and the distance that the node moves. On this basis, the heterogeneous sensor nodes are deployed in the monitoring area with obstacles to maximize network coverage, with minimum node radiation overflow rate and minimum energy consumption rate.
- 3) This paper proposes a multi-objective flower pollination algorithm based on non-dominated sorting (NSMOFPA), which uses external archive strategy and leader strategy to solve the problem of multi-objective global pollination. The elite strategy is used to speed up the convergence rate of the algorithm, and the role of the greedy crossover strategy is to improve the precision of the solution set. In addition, a crowding degree calculation method is proposed to maintain the diversity of the current solution set population. Compared with several well known multi-objective optimization algorithms, the NSMOFPA algorithm has faster convergence speed, higher precision and more uniform distribution of non-dominated solution set, which can provide a better solution for WSN optimal deployment.

The reminder of this paper is organized as follows: the related work is introduced in Section II, the relevant model

TABLE 1. WSN deployment related works.

Reference	Objective(s)	Used method(s)	Obstacle	Considered nodes	Urban /forest
[8]	Coverage rate	PSO	No	Homogeneous nodes	Urban
[9]	Coverage rate	VSFA	No	Homogeneous nodes	Urban
[10]	Coverage rate	AIFS	No	Homogeneous nodes	Urban
[13]	Coverage rate, cost and connectivity	NSGAI	No	Homogeneous nodes	Forest
[14]	Coverage rate, energy consumption rate	MODEA	Yes	Heterogeneous nodes	Forest
[15]	Coverage rate, energy consumption rate and energy balance rate	WGA	No	Homogeneous nodes	Forest
[16]	Coverage rate, energy consumption rate and energy balance rate	MOEA/D-I, MOEA/D-II	No	Homogeneous nodes	Forest

of WSN deployment and the problem model to be optimized are introduced in Section III. In Section IV, the basic flower pollination algorithm is described. Section V and Section VI present an improved flower pollination algorithm and multi-objective flower pollination algorithm, respectively. The simulation experiments and analysis are presented in Section VII. Finally, a brief conclusion of this paper and some future works are drawn in Section VIII.

II. RELATED WORK

This paper discusses the deployment environment in urban circumstance and forest circumstance, and proposes two new flower pollination algorithms. We therefore briefly discuss each circumstance in turn.

For the deployment environment shown in Fig. 1, in [8], a particle swarm optimization (PSO) algorithm based on the current search state was proposed. It was used to optimize the sensor network deployment and improve the adaptive ability of the network, but the algorithm has the disadvantage of falling into local optimum. In [9], the improved virtual spring force algorithm (VSFA) was used to deploy the regular hexagonal network topology, which effectively reduces the area of the vulnerability in the sensor network. This scheme only addresses the deployment strategy under ideal conditions, but not the complex environment. In [10], the coverage rate is the optimization goal, and the adaptive improved fish swarm algorithm (AIFS) is used to optimize the sensor deployment, which significantly improves the network coverage area and reduces the energy consumption, but only for homogeneous sensors and the ideal deployment environment.

For the deployment environment shown in Fig. 2, [13] takes network coverage, network deployment cost and connectivity of network as optimization objectives. The authors used NSGAI (a fast multi-objective genetic algorithm) to obtain a better deployment plan. However, NSGAI has a disadvantage that the distribution of non-dominated

solutions is uneven, especially on high-dimensional optimization problems. In [14], the multi-objective differential evolution algorithm (MODEA) is applied to the WSN deployment of the geometric polygon monitoring area, the coverage rate and energy consumption rate of WSN are taken as optimization objectives. A good solution is provided in [14], but the paper does not consider the energy consumption due to data transmission and reception. The works of [15]–[16] optimize the network coverage, energy consumption rate and energy balance rate, using different approaches. The work in [15] integrates the three optimization objectives into a single objective in a linear weighted manner, then uses the whale group algorithm (WGA) to optimize the single objective function. Although the method is simple, the computation time is too long. The work in [16] uses MOEA/D-I (a multi-objective evolutionary algorithm based on decomposition) and MOEA/D-II algorithms to jointly optimize the model, but it only considers the deployment of homogeneous sensor nodes and the presence of obstacles. Some works in this domain are exposed in Table 1.

FPA is a heuristic search algorithm proposed by Yang based on the way of flower pollination [18], and has been used for multi-objective optimization [25]. The algorithm has better optimization ability and convergence performance. In [19], a discrete operation was added to the FPA, and it was applied to solve the problem of flexible job shop scheduling. The simulation experiment showed that the algorithm has a better capability to search the optimal solution, but the convergence speed of the algorithm is slower. Reference [20] proposed an improved FPA based on chaos search, which improved the ability of the algorithm to jump out of local optimal and improved the precision of solution. When applied to Sudoku, the algorithm provides a better and clearer solution, but the convergence performance of the algorithm is not significantly improved. In the multi-objective optimization problem, [21] and [22] convert multiple objective functions

into a single-objective problem with a linearly weighted sum. Reference [21] optimized multi-objective power flow problems with secondary fuel cost, secondary cost, total useful work power and voltage distribution. Reference [22] optimized multi-objective power congestion management with transmission congestion, improved voltage, cost factor and actual power loss. Both papers can obtain a better Pareto front. However, when multi-objective problems are optimized by linear weighted sum, this method has a large amount of calculation, a long running time, and is not necessarily suitable for all multi-objective optimization problems.

III. MODEL AND COVERAGE OPTIMIZATION PROBLEM DESCRIPTION

In this part, we will introduce the WSN deployment model, involving node attributes, coverage calculation, energy consumption calculation, node radiation overflow rate description, as well as optimization objectives of single-objective and multi-objective WSN deployment problems.

A. HETEROGENEOUS NODE DESCRIPTION

A sensor node has a perception radius and communication radius respectively. To ensure the connectivity of the wireless sensor network, the communication radius of a node is set to be greater than or equal to twice of the perception radius. This paper assumes that sensor nodes are heterogeneous with different perception radii, communication radii and battery capacity. The set of heterogeneous nodes is denoted by $\mathbf{Type} = \{type_1, type_2, type_3, \dots, type_n\}$, with the corresponding sets of perception radii $\mathbf{r} = \{r_1^p, r_2^p, r_3^p, \dots, r_n^p\}$, communication radii $\mathbf{R} = \{R_1^c, R_2^c, R_3^c, \dots, R_n^c\}$, node numbers $\mathbf{N} = \{N_1, N_2, N_3, \dots, N_n\}$, and initial battery capacity $\mathbf{E} = \{E_1, E_2, E_3, \dots, E_n\}$.

B. COVERAGE RATE DESCRIPTION

In a WSN, suppose there is a set of wireless sensor nodes $\mathbf{S} = \{s_1, s_2, s_3, \dots, s_n\}$, a set of monitoring nodes $\mathbf{M} = \{m_1, m_2, m_3, \dots, m_n\}$, (x_i, y_i) and (x_j, y_j) correspond to the two-dimensional coordinates of s_i and m_j respectively. Then the Euclidean distance between the two nodes is given by:

$$d(s_i, m_j) = \sqrt{(x_i - x_j)^2 + (y_i - y_j)^2} \quad (1)$$

The probability that the monitoring point m_j is perceived by the node s_i can be computed as follows:

$$p_{cov}(s_i, m_j) = \begin{cases} 1 & \text{if } d(s_i, m_j) \leq r^p \\ 0 & \text{otherwise} \end{cases} \quad (2)$$

The joint perceived probability of all sensor nodes to point m_j is:

$$C_p(s_{all}, m_j) = 1 - \prod_{i=1}^n (1 - p_{cov}(s_i, m_j)) \quad (3)$$

where s_{all} is all sensor nodes in the monitoring range. Suppose the monitoring area with rectangular shape is $L_1 \cdot W_1 m^2$.

For the convenience of calculation, the rectangle is divided into $L_1 \cdot W_1$ small grids, and one monitoring node is located at the center of a grid. The joint perception probability of a monitoring point is calculated by (3). The sum of the areas of all the monitored grids is the coverage area. Coverage rate C_r can be expressed as follows:

$$C_r = \sum_{x=1}^{L_1} \sum_{y=1}^{W_1} C_p(s_{all}, m_{(x-1) \cdot W_1 + y}) / L_1 \cdot W_1 \quad (4)$$

C. ENERGY CONSUMPTION DESCRIPTION

The control of energy consumption is particularly important for the life span of a WSN, where the lower the energy consumption and the longer the life span. The energy consumption considered in this paper consists of three parts, the first part is the energy consumed by completing the task of perception (radiation), the second part is the energy consumed by sending data and receiving data, and the third part is the energy consumed by the node movement after deployment.

In the first part, using the same model of energy consumed by perception as in [14], the energy consumption of a node E_a is proportional to r_i^p , as described below:

$$E_a = \eta \cdot \sum_{i=1}^n (r_i^p)^2 \quad (5)$$

where η is the parameter of perception, r_i^p is the perception radius of node s_i , and n is the number of nodes.

The energy consumption of the second part is composed of the energy consumed by the circuit when the node sends and receives data. The data is transmitted by the flooding protocol [26].

If node i sends a packet of length k bits to node j , the energy consumption of node i is as follows:

$$E_{Tx}(k) = k \cdot E_{elet} + \tau \quad (6)$$

The energy consumed by node j to receive this packet is described as follows:

$$E_{Rx}(k) = k \cdot E_{eler} + \tau \quad (7)$$

Total energy consumed by a packet transmission between node i and j can be described as follows:

$$E_{ij}(k) = E_{Tx}(k) + E_{Rx}(k) \quad (8)$$

The total energy consumed by the entire network for data transmission can be described as follows:

$$E_b = \sum E_{ij}(k) \quad (9)$$

Note that E_{elet} and E_{eler} represent the energy consumed by transmitting and receiving 1 bit data, respectively, and τ is the energy consumed by noise interference when transmitting and receiving data, and E_b is the total energy consumed by the entire network to complete the transmission and reception of k -bit data.

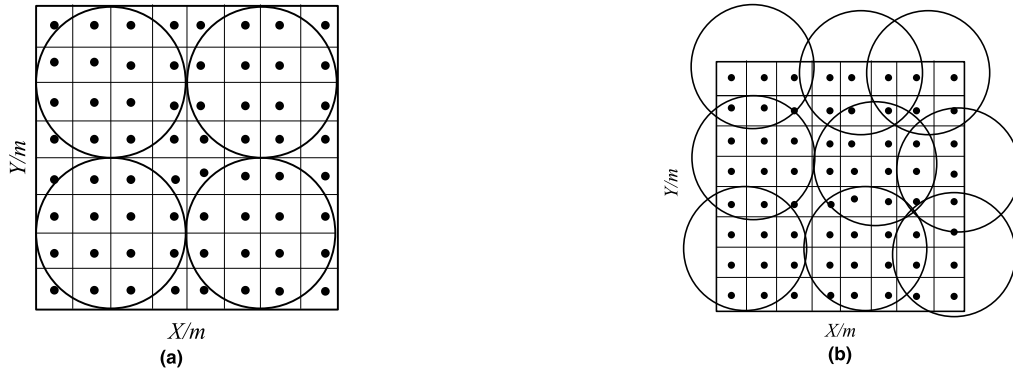

FIGURE 3. Maximizes coverage area and overflow area.

The energy consumption of the third part is the energy consumed by the moving nodes, which is represented by E_c . The location of all sensing nodes can be accurately obtained by GPS or positioning algorithm [15]. After the optimal deployment algorithm is completed, the nodes need to be moved to their optimal positions. In this paper, the LAPJV algorithm in [27] is adopted for optimal assignment, so that the sum of the moving distance of all nodes is minimum, that is, the total energy consumption is minimum. Reference [9] mentioned that the energy consumed by the node’s moving distance can be described as:

$$E_c = l \cdot D_{all} \tag{10}$$

Assuming that the total moving distance is D_{all} , l is the energy consumed per meter of movement, so the total energy consumed under the model is the product of l and D_{all} . It should be noted that the third part of energy consumption only needs to be discussed in the deployment, and its energy consumption is small. E_s is the total energy consumed by the deployment of the WSN. E_{all} is the total energy of all sensor nodes, so the energy consumption rate E_r can be expressed as follows:

$$E_s = E_a + E_b + E_c \tag{11}$$

$$E_r = \frac{E_s}{E_{all}} \tag{12}$$

D. NODE RADIATION OVERFLOW RATE DESCRIPTION

Reference [10] mentions the calculation of node radiation overflow area, but it only discusses the situation in which node radiation overflows monitoring area. On this basis, this paper adds the discussion of node radiation overflowing to obstacles. When the overflow area is large, not only the node radiation energy is wasted, but also after the node energy is exhausted, there will be a large coverage hole in the network. Therefore, the radiation overflow rate of nodes can reflect the stability and adaptability of the network.

Definition 1 (Maximum Coverage Area): The sensing range of the node does not exceed the monitoring area, and there is no overlap between any sensor nodes.

Definition 2 (Overflow Area): The total area of the radiation beyond the monitoring area and overflowing into the obstacle area.

Referring to Fig. 3(a), the maximum coverage area is denoted as S_m . In order to facilitate calculation, a monitoring point is added into the grid of the monitoring area. The small black point in the figure is the monitoring point, if the node covers the small black point, it is considered to cover the small square area ($1m^2$) where the small black point is located, and S_m is described by Eq. (13). The number of nodes is n , a_i is the maximum coverage area of node i , and S_m is the sum of the maximum coverage areas of all nodes.

$$S_m = \sum_{i=1}^n a_i \tag{13}$$

In Fig. 3(b), the area beyond the monitoring area is the overflow area, which is the overflow portion and the waste of radiation, which is denoted as S_w . Therefore, the overflow area S_w and overflow rate W_r can be expressed as follows:

$$S_w = S_m - \sum_{j=1}^{m_s} c_j \tag{14}$$

$$W_r = \frac{S_w}{S_m} \tag{15}$$

where m_s is the number of monitoring points, and c_j is the number of times that monitoring point j is covered by nodes. For example, in Fig. 3 (a), one node covers twelve monitoring points, so $S_m = 4 \times 12 = 48$. In Fig. 3 (b), $S_m = 9 \times 12 = 108$. By Eqs. (14) and (15), $S_w = 84$, so $W_r = (108 - 84)/108 = 22.2\%$.

E. OPTIMAL ASSIGNMENT DESCRIPTION

When the deployment optimization of sensor nodes is completed by swarm intelligent algorithm, the randomly deployed sensor nodes need to be moved to the final deployment location, and the sum of the moving distances of all nodes must be minimized. Therefore, we adopt the optimal assignment algorithm to plan the moving scheme.

Definition 1 (WSN Node Optimal Assignment): The randomly deployed sensor nodes are moved to the specified

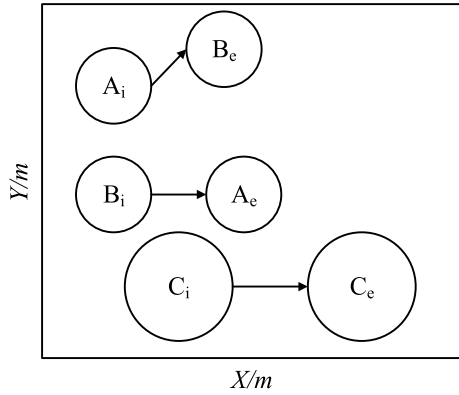

FIGURE 4. Node optimal assignment mobile deployment.

location, while meeting the minimum sum of the moving distances of all nodes.

It is worth noting that the types of the two sensors assigned must correspond to each other. As shown in Fig. 4, the rectangle represents the monitoring area, where nodes A and B belong to the same type, C is another type, the node with subscript *i* indicates the initial deployment location, and the subscript with *e* indicates the final optimized deployment location. It can be seen that the optimal assignment is (*A_i*, *B_e*), (*B_i*, *A_e*) and (*C_i*, *C_e*), at which time the total distance of movement is the smallest, and the types correspond to each other. The assignment algorithm used in [14] is Hungarian algorithm, [28] points out that the LAPJV algorithm is faster and consumes less computer memory and time than the Hungarian algorithm. Therefore, this paper adopts the LAPJV assignment algorithm proposed in [27].

F. POSITION CORRECTION DESCRIPTION

In order to better meet the actual deployment situation of WSNs, this paper adds geometric obstacles in the monitoring area, such as triangular obstacles in the shaded part in Fig. 5. When the algorithm optimizes the deployment of nodes, it may encounter the following two special situations.

a. In Fig. 5, node *b* is inside the obstacle, and its position needs to be corrected. The practice of this paper is to make a line *CD* perpendicular to the obstacle with the point *b* as one end, corresponding to *h* in Eq. (16), the length of the line segment *CD* is twice the perception radius of the node, and the corrected position is a random point on the line segment *CD*, represented by $r \otimes h$, $r \in [0,1]$, and p_s is the corrected node position. In Fig. 5, *b'* is the corrected position of node *b*.

$$p_s = r \otimes h \tag{16}$$

b. If the node is not in the monitoring area, as node *a* in Fig. 5, a position is randomly generated in the monitoring area $\in [l_1, l_2]$, and node *a'* is the corrected position. The mathematical description is as follows:

$$p_s = l_1 + r \cdot (l_2 - l_1) \tag{17}$$

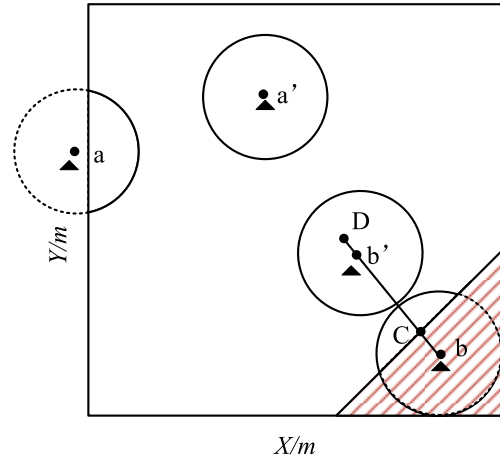

FIGURE 5. Node deployment with obstacles in the monitoring area.

G. NETWORK CONNECTIVITY DESCRIPTION

Network connectivity is the most basic requirement of WSNs, as mentioned in the above heterogeneous node model, *S*, *r* and *R* correspond to node set, perception radius set and communication radius set respectively. For ease of calculation, assume $2r^p = R^c$, a directed graph adjacency matrix *M_v* is established, which is used to store the connectivity of any two nodes, and is judged to be connected according to Eq. (18). *M_v*[*i*][*j*] = 1 indicates that node *i* can transmit data to node *j*(one-way communication), otherwise they are disconnected. Then, according to the matrix power algorithm of [29], it can be judged whether the whole network is connected using the matrix *S_v* which is calculated by Eq. (19).

$$M_v [i] [j] = \begin{cases} 1 & \text{if } d(s_i, s_j) \leq R_i^c \\ 0 & \text{otherwise} \end{cases} \tag{18}$$

$$S_v = M_v + M_v^2 + M_v^3 \dots + M_v^{n-1} \tag{19}$$

where *n* is the number of sensor nodes, if there is an element in *S_v* that is 0, the network is not connected, otherwise, it is connected. On the basis of WSN connectivity, the minimum spanning tree can be generated using the Kruskal algorithm [30].

H. SINGLE OBJECTIVE DEPLOYMENT OPTIMIZATION PROBLEM

As shown in Fig. 1, when sensor nodes are deployed in urban residential areas, the node battery can be solar-charged. Therefore, we only need to optimize the coverage of the network. The larger the coverage rate, the better the deployment effect. *I* is the position coordinate, perception radius and communication radius matrix of a group of sensor nodes. Based on the description in Section III. B, the problem is as follows:

$$f_1(I) = \text{Max} (C_r (I)) \tag{20}$$

I. MULTI-OBJECTIVE DEPLOYMENT OPTIMIZATION PROBLEM

As shown in Fig. 2, when the sensor node is deployed in a forest environment, because the node battery is not rechargeable, the battery capacity is critical to the network life span, the smaller the energy loss, the longer the network life span. In addition, when the radiation of the node is mostly in the monitoring area, the coverage area of the node can be maximized. Hence, the smaller the area outside the monitoring area and within the obstacle of the node’s radiation, the more effective reduction of the network hole, which is conducive to the secondary deployment of the network. Coordinate positions, residual energy, perception radius, and communication radius of a set of sensor nodes are denoted as \mathbf{O} .

$f_1(\mathbf{O})$ indicates the maximum WSN coverage rate.

$$f_1(\mathbf{O}) = \text{Max}(C_r(\mathbf{O})) \tag{21}$$

$f_2(\mathbf{O})$ indicates the minimum node radiation overflow rate.

$$f_2(\mathbf{O}) = \text{Min}(W_r(\mathbf{O})) \tag{22}$$

$f_3(\mathbf{O})$ indicates minimizing WSN energy consumption rate.

$$f_3(\mathbf{O}) = \text{Min}(E_r(\mathbf{O})) \tag{23}$$

IV. FLOWER POLLINATION ALGORITHM

FPA is a heuristic search algorithm proposed by Yang in 2012, it is based on the pollination process of flowering plants in nature. The algorithm takes cross-pollination as global pollination and self-pollination as local pollination for evolution, and has better optimization ability and convergence speed. FPA has been proved to have better performance than GA and PSO in multi-peak test functions [18].

In nature, flowering plants pollinate in two ways: cross-pollination and self-pollination. Cross-pollination is completed by pollinators (birds, bees, insects), pollen can be spread over long distances by pollen carriers, so it can cross the gap between flowers and make information exchange with distant flowers. Therefore, in FPA, heterogeneous pollination is called global pollination. Self-pollination is the exchange of information with nearby flowers by means of wind, it is similar to the process of self-crossing in plants, this pollination method is called local pollination in FPA. The conversion of cross-pollination and self-pollination is regulated by the parameter p . In order to simplify the problem, in FPA, it is assumed that each plant only has one flower and one flower has only one pollen gamete, which is a potential solution to the problem. For the convenience of description and understanding, the following description of pollen mating is replaced by solution of algorithm.

A. GLOBAL POLLINATION OF FLOWERS

In FPA, when global pollination is carried out, pollens are carried by pollinators such as birds, bees and insects to spread the pollens to any place, which can be regarded as global search. Because birds’ flight behavior has Levy flight characteristics, that is, the step size of global pollination follows

Levy distribution. Global pollination can be described as follows:

$$X_i^{t+1} = X_i^t + \gamma \cdot L \cdot (X^{best} - X_i^t) \tag{24}$$

The vector X^{best} represents the best individual or vector solution in the iteration so far, X_i^t is the t -th generation (current generation) individual or vector solution, X_i^{t+1} is the $t + 1$ -th generation (next generation) individual or vector solution. L is the intensity of global pollination, it is the step size of pollen movement, γ is a scaling factor for controlling step size. Assuming that birds carry pollen and the flight of birds follows the Levy distribution. The mathematical description of Levy distribution is as follows:

$$L \sim \frac{\lambda \Gamma(\lambda) \sin(\frac{\pi\lambda}{2})}{\pi} \cdot \frac{1}{s^{1+\lambda}}, \quad (s \gg s_0 > 0) \tag{25}$$

where $\Gamma(\lambda)$ is the standard gamma function, s is Levy flight step size, s_0 represents the minimum step size, and s is generated by using the method of [25].

$$s = \frac{U}{|V|^{\frac{1}{\lambda}}}, \quad U \sim N(0, \sigma^2), \quad V \sim N(0, 1) \tag{26}$$

$$\sigma^2 = \begin{cases} \Gamma(1 + \lambda) \cdot \sin(\frac{\pi\lambda}{2}) \\ \Gamma[\frac{1+\lambda}{2}] \cdot \lambda \cdot 2^{\frac{\lambda-1}{2}} \end{cases} \tag{27}$$

In the formula, U and V obey the Gaussian distribution, and λ is a constant, which is generally set to 1.5 [18].

B. LOCAL POLLINATION OF FLOWERS

In FPA, local pollination is the transmission of pollen through abiotic (wind) and the distance of transmission is relatively short, which enables neighboring pollen to exchange information with each other and can be regarded as local search. The description is as follows:

$$\begin{cases} X_i^{t+1} = X_i^t + \varepsilon \cdot (X_j^t - X_k^t) \\ \varepsilon \sim U(0, 1) \end{cases} \tag{28}$$

where X_i^{t+1} is the individual produced by $t + 1$ -th generation, X_j^t, X_k^t respectively represent the j -th and k -th individuals in the t -th generation, and ε is the local pollination coefficient and is uniformly distributed in $[0,1]$. It can be seen from the above formula that the product of the distance between any two individuals and the random fraction ε will remain in the i -th individual and be preserved in the next generation.

C. SWITCH PROBABILITY P

In FPA, there are two pollination modes, namely global pollination and local pollination, and p is the switch probability of the two modes. In [18], it has been proved that when p is 0.8, it has good effect in most application scenarios. The switch probability p is described as follows:

$$\text{pollination mode} = \begin{cases} \text{global pollination} & \text{if } r < p \\ \text{local pollination} & \text{otherwise} \end{cases} \tag{29}$$

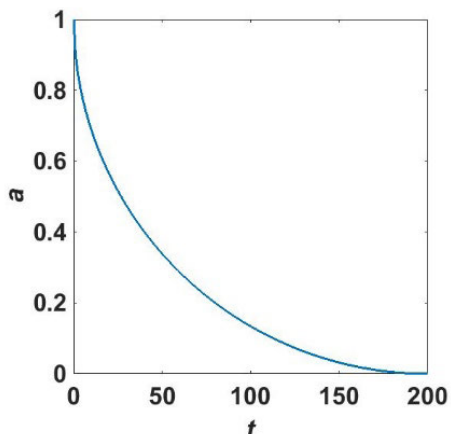

FIGURE 6. a convergence factor.

In the above formula, $r \in [0,1]$, if $r < p$, global pollination is performed, and otherwise, local pollination is performed.

The FPA fitness calculation method can be expressed by Eq. (30), X is an individual in the population, and the fit is an abstract expression of the optimization problem. It should be noted that the mathematical expressions are different for different optimization problems.

$$fitness = fit(X) \tag{30}$$

V. IMPROVED FLOWER POLLINATION ALGORITHM

A. NONLINEAR CONVERGENCE FACTOR STRATEGY

In FPA, the scaling factor γ of global pollination is a fixed value of 0.01, which is the same strategy for the early and late stages of the algorithm, so it is not flexible, resulting in slow convergence speed. In order to improve the search efficiency of the algorithm, a convergence factor a is proposed to constrain the original γ scaling factor. Fig. 6 plots the convergence factor, which is described mathematically as follows:

$$a = 1 - \sqrt{1 - \left(\frac{T-t}{T}\right)^2} \tag{31}$$

T is the maximum number of iterations, and t is the current number of iterations. As shown in Fig. 6, the value of a decreases nonlinearly from 1 to 0, in the early stage of iteration, the value of a is large, that is, the moving step length of the algorithm is large, which is conducive to global optimization search and accelerates the convergence speed of the algorithm. At the later stage of iteration, the value of a is small, that is, the step length of the movement is small, and the rate of change is small, which is beneficial to the local optimization search, thereby improving the precision of the solution. The global pollination of the new algorithm can be expressed as follows:

$$X_i^{t+1} = X_i^t + a \cdot \gamma \cdot L \cdot (X^{best} - X_i^t) \tag{32}$$

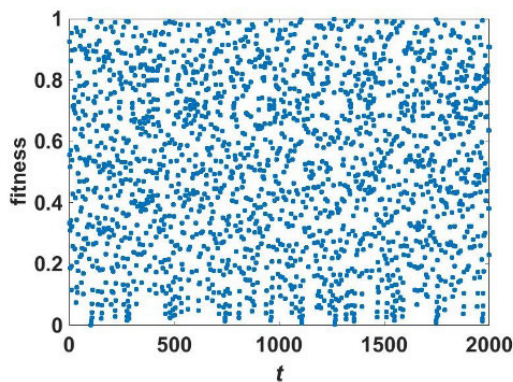

FIGURE 7. Tent map.

B. TENT CHAOTIC MAP

Many of the intelligent optimization algorithms mentioned in [31], [32] use chaotic maps to generate search sequences. [33] has proved that chaotic maps can enrich the diversity of the initial population and enable the algorithm to search for better solutions. Tent chaotic maps are widely used, the main reason is that Tent maps are distribution functions, the chaotic sequences generated by Tent maps do not require much initial value of distribution functions and have global ergodicity. The most basic Tent mapping is mentioned in [31]. The mathematical description is as follows:

$$x_{t+1} = \begin{cases} x_t, & 0 \leq x_t \leq 0.5 \\ 1 - x_t, & 0.5 < x_t \leq 1 \end{cases} \tag{33}$$

Assuming that the random number generated in the first loop is $x_1 = 0.1999$, the chaotic sequence obtained after 2000 loops is shown in Fig. 7, which is the location of the flowers. It can be seen from the figure that the locations of flowers are evenly distributed, which is conducive to the later search.

Tent mapping is used in two steps of the algorithm in this paper. On the one hand, it is used to initialize the population, on the other hand, it is used to solve the problem of iteration stagnation in the later stage of the algorithm. Therefore, at the beginning of the algorithm, two populations are generated, one of which is used to initialize the population and enrich the diversity of the population, when the algorithm falls into a local optimal state. The other is used to maintain the diversity of the population and replace some variables of some individuals in the original population, thus enhancing the ability of the algorithm to jump out of local optimization. When the difference between the average fitness values of the parent and the child populations is less than a specific value θ ($\theta = 0.0003$ in WSN deployment), Tent chaotic mapping is performed in this paper.

C. GREEDY CROSSOVER STRATEGY

In FPA, each iteration is based on a greedy strategy. Although this strategy is beneficial to the superior individuals in the

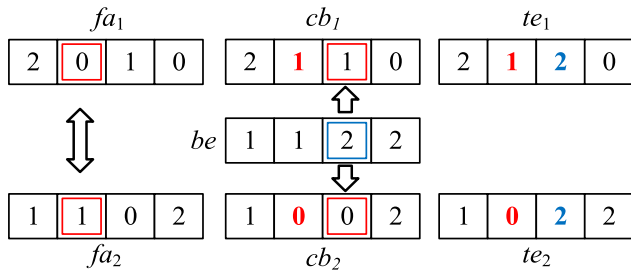

FIGURE 8. Greedy crossover step.

parent generation not to be destroyed, it does not fully search the locations near the individuals. Therefore, after the completion of global pollination or local pollination, we introduce a crossover strategy similar to the genetic algorithm [34] to make its local search more efficient, and adds some variables of the current optimal individual to the crossover individual. This strategy still abides by greedy strategy, which is called greedy crossover strategy. The steps are as follows:

Step a: Randomly select two parent individuals (fa_1, fa_2), fa_1 does not equal fa_2 , they cross some variables with each other to obtain new crossover individuals cb_1 and cb_2 , and then replace some variables in the crossover individual with the current optimal individual (be), and obtain temporary individuals te_1 and te_2 respectively.

Step b: Comparing the parent individual with the corresponding temporary individual, if the fitness value of the temporary individual is better than that of the parent individual, the parent individual is replaced, otherwise, no replacement is made.

Fig. 8 is a greedy crossover strategy step, the role of greedy crossover strategy is to make other individuals obtain some variables of the best individual, and any two individuals cross each other. As the iteration progresses, the precision of the solution will be improved. In addition, in FPA, the current best individual X^{best} is updated only once per generation, but we change this strategy, updating X^{best} in real time as long as the individual updates the location. Hence, the convergence performance of the algorithm is enhanced.

D. IFPA PSEUDO CODE

The IFPA pseudo code is as follows:

E. TIME COMPLEXITY ANALYSIS

Assume that the maximum number of iterations of the algorithm is T , the population size is N , and the dimension of the optimization problem is D . In FPA, the population is initialized with a time complexity of $O(ND)$. Each iteration needs to complete the following steps, firstly, the fitness value of the population is calculated and the optimal individual in the population is found, its time complexity is $O(N)$. Then the pollination position is updated, its time complexity is $O(N)$. Therefore, the time complexity of each iteration is $O(N + N)$, the total time complexity of FPA is $O(T(N + N) + ND)$, which is $O(TN)$. Compared to FPA, IFPA adds Tent mapping and crossover strategy, but it still belongs to the flower update

TABLE 2. Improved flower pollination algorithm.

Algorithm 1: Improved Flower Pollination Algorithm	
Input:	Population size N , switch probability p , maximum number of iterations T
Output:	Best flower X^{best}
1	Initialize the flower population F with Tent mapping
2	for $t = 1$ to T do
3	Calculate fitness of F by Eq. (30), find best flower as X^{best}
4	Update Convergence factor a by Eq. (31)
5	for $i = 1$ to N
6	if $rand < p$
7	Draw L which obey Levy distribution by Eqs. (25), (26) and (27)
8	Perform global pollination by Eq. (32)
9	Update best flower X^{best}
10	else
11	Draw $a\epsilon$ which obey uniform distribution in $[0,1]$
12	Random choose j and k in the population
13	Perform local pollination by Eq. (28)
14	Update best flower X^{best}
15	end
16	Perform greedy crossing among individuals
17	Perform a Tent chaotic map by Eq. (33)
18	Calculate the fitness of new flower by Eq. (30), if new flower is better, update it in the population
19	Update best flower X^{best}
20	end
21	end

position operation, and does not add extra time complexity, so the total time complexity of IFPA is consistent with FPA.

F. DESCRIPTION OF IFPA APPLIED TO WSN

1). Set the number of sensor groups (population) N , the number of sensor nodes (dimension) D and the range of monitoring area.

2). I_s represents the position and radius of N groups of sensor nodes, I_s is initialized first, and then I_1 is selected as the initialization plan.

3). According to Eq. (4), the coverage rate of each group of deployment plans is obtained. Our optimization goal is to obtain the node deployment plan corresponding to the maximum network coverage.

4). IFPA is used to optimize the deployment of WSN. In the monitoring area with obstacles, if the node radiation enters the obstacle area or overflows the monitoring area, the node position is corrected according to Eqs. (16) and (17) respectively. After the algorithm is finished, a set of deployment plan I_2 with the largest coverage is obtained.

5). Judge the connected state of the network according to Eq. (19). If it is not connected, choose a suboptimal group of deployment schemes until a connected group of schemes.

6). The optimal assignment scheme between I_1 and I_2 is generated according to the LAPJV algorithm in [27], and the nodes in I_1 are moved to the corresponding positions in I_2 .

7). Generate a minimum spanning tree according to the Kruskal algorithm mentioned in [30].

VI. MULTI-OBJECTIVE FLOWER POLLINATION ALGORITHM

The ultimate goal of the multi-objective optimization algorithm is to optimize the non-dominated solution set, making

the Pareto front distribution more uniform and closer to the true Pareto front. For relevant knowledge of dominance and non-dominance, Pareto optimal solution, Pareto front, readers are referred to [35].

At present, multi-objective flower pollination algorithms mostly convert multiple objectives optimization problems into a single objective by linear weighted summation [22], [23], which becomes the problem of optimizing single objective, but all optimization goals need to be converted into the same kind, that is, all objectives are maximized or minimized. In addition, the fitness value of multiple objectives need to be dimensionlessly processed. The common processing method is normalization [14].

$$f = \sum_{i=1}^M w_i f_i, \quad \sum_{i=1}^M w_i = 1, \quad w_i > 0 \quad (34)$$

where M is the number of objectives to be optimized, f_i is the value of the i -th objective function, w_i is the corresponding weight, and all multi-objective are combined into a single objective using the weighted sum. The method is simple, but the running time is long, and the strategy is not suitable for all multi-objective optimization problems. Therefore, we propose a non-dominated sorting Multi-objective flower pollination algorithm (NSMOFPA).

A. FAST NON-DOMINATED SORT

In order to quickly obtain the dominant and non-dominant relationship between individuals, NSMOFPA introduces the fast non-dominant sorting algorithm first proposed in NSGAI, its role is to layer the population according to Pareto's ranking, detailed steps of the algorithm can be found in [36].

B. CROWDING DEGREE

In NSGAI, in order to expand the search range of the algorithm and enrich the diversity of the non-dominated solution set, the crowded distance strategy was proposed. Compared with the crowded distance calculation proposed by NSGAI, the calculation of the crowding degree proposed in this paper is more reasonable, simpler and easier to implement than the adaptive grid method in MOPSO.

$$\prod_{i=1}^M \left[\max(f_i^1, f_i^2, f_i^3) - \min(f_i^1, f_i^2, f_i^3) \right] \quad (35)$$

where f_i^2, f_i^1 and f_i^3 represent the fitness value of the current individual, the left neighbor, and the right neighbor on the i -th objective function respectively.

Fig. 9 shows the crowding degree of the solution set. The optimization functions $f1$ and $f2$ need to be minimized, A, B and C are true Pareto solution sets, the curve formed by their connecting lines is Pareto front, D, E and F are non-dominated solution sets found in the current iteration, they are not dominated by each other. For individual E, the crowding degree is the product of $d1$ and $d2$, and the crowding degree of individual D and F is set to infinity. The steps of the algorithm are as follows:

TABLE 3. Non-dominated sorting multi-objective flower pollination algorithm.

Algorithm 2: Non-dominated sorting Multi-objective Flower Pollination Algorithm	
Input:	Population size N , switch probability p , maximum number of iterations T , objective number M
Output:	Optimal Solutions Z
1	Initialize the flower population F with random solutions, leader = F
2	for $t = 1$ to T do
3	// Generate new population A by local pollination and global pollination
4	for $i = 1$ to N
5	if $rand < p$
6	Perform global pollination by Eq. (24)
7	else
8	Perform local pollination by Eq. (28)
9	end
10	Perform greedy crossover among individuals
11	end
12	Get flower population $B = A \cup F$, and get fitness of B as C by Eq. (30)
13	C performs fast non-dominated sorting, as D after layering, and adds the first layer to the archive
14	Sort the archive in reverse order according to the crowding degree by Eq. (35)
15	If the size of the archive exceeds N , keep the first N
16	Update the leader according to the roulette algorithm
17	The same layer of fitness values in C are sorted according to the crowding degree from large to small
18	The first N in B are saved to Z by Eq. (36)
19	$F = Z$
20	end

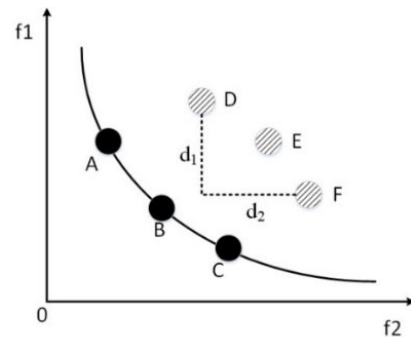

FIGURE 9. Crowding degree.

Step a: For individuals of the same Pareto rank, the same level individuals are sorted according to the fitness value of any one of the objective functions.

Step b: Traversing the individuals of the level, setting the congestion crowding of the first and last individuals of the level to infinity, and calculating the crowding degree of other individuals according to Eq. (35).

C. EXTERNAL ARCHIVE STRATEGY AND LEADER STRATEGY

In the process of global pollination of flowers, some information needs to be obtained from the optimal individuals. Therefore, learning from the external archive strategy and leader strategy in MOPSO is used to solve the global pollination problem of multi-objective flower pollination algorithm. Firstly, the archive strategy is introduced, the storage capacity

of archive is fixed [35]. The steps of archive strategy are as follows:

Step a: In each iteration, the non-dominated solution set of the current population is stored in the archive, and then the individuals in the archive are non-dominated sorted to obtain the individuals with the highest Pareto rank, then all the individuals in the archive are the current optimal solution set.

Step b: If the number of individuals in the archive exceeds the storage capacity of the archive, the individuals are ordered in reverse order according to the crowding degree, the larger the crowding degree value, the better the diversity, and the ordered individuals are stored in the archive again until the archive capacity is full.

The leader is similar to the archive, but the capacity of the leader is consistent with the capacity of the population. The role of the leader is to cooperate with the global pollination step of the flower, leading other individuals to approach the current optimal solution set, thus obtaining a better non-dominated solution set and improving the precision of NSMOFPA. We use the roulette algorithm in [37] to initialize the leader. The greater the value of the crowding degree, the greater the probability of being selected, thus enhancing the uniformity performance of the algorithm.

D. ELITE STRATEGY

Learning from the elite strategy mentioned in NSGAIL, NSMOFPA adopts the elite strategy. In order to expand the diversity of the population and avoid the loss of Pareto optimal solutions in the parents generation, the parents generation and the children generation need to compete together for the opportunity to enter the next iteration. The size of the population is N , the parent population and the child population are merged together, and the individuals in the population are eliminated according to their Pareto grades, as described in Eq. (36):

$$P_0 = P_1 \oplus P_2, \quad (36)$$

where P_1 is the parent population, P_2 is the children population, P_0 is the new population generated after competition, \oplus indicates that the populations compete with each other, and the competition rules are as follows:

- a. In the mixed population, Pareto grades (layer) are obtained according to the fast non-dominated sorting algorithm.
- b. Individuals on the same grade are ordered in reverse order according to the crowding degree.
- c. Putting the first N individuals of the mixed population into the population P_0 , and performing the next iteration.

E. NSMOFPA PSEUDO CODE

Different from the basic flower pollination algorithm, NSMOFPA does not need to be greedy for each step because of the elite strategy. The pseudo code is shown in Table 3.

F. TIME COMPLEXITY ANALYSIS

Assume that the maximum number of iterations of the algorithm is T , the population size is N , the number of weights is W , the dimension of the optimization problem is D , and the number of optimization objectives is M . In [16], the population is initialized with a time complexity of $O(ND)$ and the time complexity of initialization weight groups is $O(MW)$. Each iteration needs to perform the following operations to calculate the fitness value of the population and find the best individual, with the time complexity of $O(N)$, and the time complexity of global pollination and local pollination to update the individual location is $O(N)$, the time complexity of each iteration is $O(N + N)$, so the total time complexity of MOFPA is $O(WT(N + N) + ND + MW)$. In NSMOFPA, the initial population time complexity is consistent with MOFPA, which is $O(ND)$. Each iteration consists of the following steps. Firstly, the flower population of the children is generated according to the global and local pollination of the flower, the time complexity is $O(N)$, the fitness value of the parents and the children population is calculated, the time complexity is $O(2N)$, and the time complexity of fast non-dominated sorting is $O(M(2N)^2)$. Secondly, the crowding degree strategy is performed as $O(M(2N)\log(2N))$, and the time complexity of sorting of crowding degree is $O((2N)\log(2N))$. Thirdly, the time complexity of the external archive strategy is $O(N)$, and the time complexity of the leader strategy is $O(N + N^2 + N^2)$. Finally, the time complexity of the parents and children generation competing into the next iteration is $O(N)$. Therefore, the time complexity of each iteration is $O(6N + (4M + 2)N^2 + (2MN + 2N)\log 2N)$, and the total time complexity of NSMOFPA is $O(T(6N + (4M + 2)N^2 + (2MN + 2N)\log 2N) + ND)$. Comparing the highest order of magnitude of the time complexity of two multi-objective algorithms, the value of W in MOFPA is usually the same as N , so the MOFPA time complexity is $O(TN^2)$, whereas NSMOFPA is $O(TMN^2)$. When the number M of optimization objective is small, the time complexity of the two algorithms is almost the same.

G. STEPS FOR APPLYING NSMOFPA TO WSN

- 1). Set the number of sensor groups (population) N , the number of sensor nodes (dimension) D and the range of monitoring area.
- 2). O_s represents position, radius and residual energy of N groups of sensor nodes, O_s is initialized first, and then O_1 is selected as the initialization plan.
- 3). According to Eq. (4), the coverage rate of each group of sensor nodes is obtained, the corresponding energy consumption rate is obtained by Eq. (12), and the corresponding node radiation overflow rate is obtained by Eq. (15). The three objective functions are constrained according to Eqs. (21), (22), and (23).
- 4). Using NSMOFPA to optimize the multi-objective deployment problem of WSN. When a node radiates into the obstacle or exceeds the monitoring area, the node position is

TABLE 4. Description of the comparison algorithms.

Algorithm	Full name of algorithm	Reference	Time complexity
GA	Genetic algorithm	[34]	$O(TN)$
PSO	Particle swarm optimization	[8]	$O(TN)$
DEA	Differential evolution algorithm	[37]	$O(TN^2)$
FPA	Flower pollination algorithm	[18]	$O(TN)$
IFPA	Improved flower pollination algorithm	This paper	$O(TN)$
NSGAI	Multi-objective genetic algorithm based on fast non-domination	[13]	$O(TMN^2)$
MOPSO	Multi-objective particle swarm optimization	[35]	$O(TMN^2)$
MODEA	Multi-objective differential evolution algorithm	[14]	$O(TN^2)$
MOFPA	Multi-objective flower pollination algorithm	[25]	$O(TN^2)$
NSMOFPA	Non-dominated sorting Multi-objective flower pollination algorithm	This paper	$O(TMN^2)$

corrected according to Eqs. (16), (17) respectively. After the algorithm ends, multiple groups of sensor node deployment plans Q (optimal solution sets) are obtained.

5). According to Eq. (19), the network connectivity of deployment plan in Q is judged, and the disconnected deployment plan is discarded.

VII. SIMULATION EXPERIMENTS AND ANALYSIS

In this part, two groups of experiments are conducted. The first experiment simulates the deployment of sensor nodes in cities. With coverage as the optimization goal, five single-objective algorithms are used to optimize network deployment, which can be used to test the convergence performance and search accuracy of the algorithm. In experiment 2, five multi-objective algorithms are applied to wireless sensor multi-objective deployment, and the experimental results are analyzed. The experiments are carried out in an Intel core i5 dual-core CPU with a frequency of 2.4GHz, 8GB of memory and Windows 10 operating system. The experimental simulation software is MATLAB 2014b. The comparison algorithms involved in the experiment are shown in the following table.

A. EXPERIMENT 1: WSN COVERAGE OPTIMIZATION DEPLOYMENT

The experiment is designed with the wireless sensor network coverage as the optimization goal. There are 3 types of sensor nodes, the perception radius is 5m, 6m and 7m respectively, and the communication radius is twice the perception radius. The experimental monitoring area is a polygon and the obstacle type is diamond, and the purpose of this is to increase the difficulty of deployment. In addition, we compare the classical particle swarm deployment method of [8] with IFPA, and other comparison algorithms can be found in Table 4. The size of the population of the five single-objective algorithms is uniformly set to 50, and the number of iterations is 200. A total of 20 experiments are performed, and the final average results are compared. The specific experimental parameters are as follows:

Figures 10-13 show the effect of deploying 25 heterogeneous sensor nodes in a deployment environment where the monitored area is a polygonal and contains obstacles. Fig. 10 shows the effect of random node deployment,

TABLE 5. Experimental parameter settings.

Area size (m ²)	Radius is 7	Radius is 6	Radius is 5	Obstacle shape	Number of nodes
1850	1	2	22	diamond	20, 25, 30, 35, 40, 45, 50

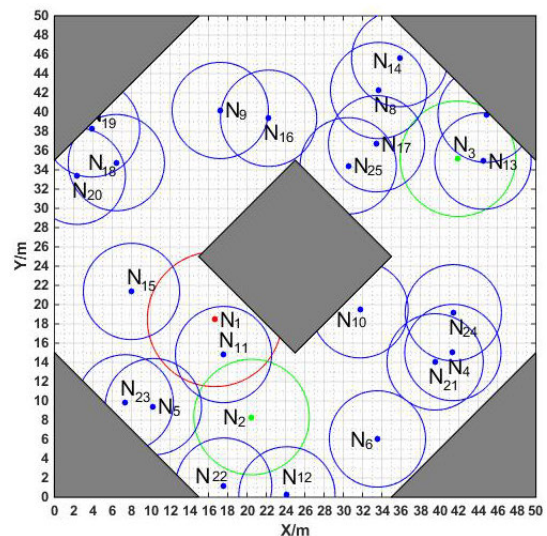

FIGURE 10. Initial deployment WSN.

the coverage rate is 65.96%, it can be seen that the nodes are unevenly distributed and the network is not connected. After IFPA optimization deployment, the deployment effect is shown in Fig. 11, at this time, the coverage rate increases by 29.62 to 95.58%, the effect is remarkable. Fig. 12 depicts the deployment effect diagram after optimal assignment using the LAPJV algorithm, (19i, 10e) indicates that the 32th node (Fig. 10) should be moved to the 10th node (Fig. 11). Fig. 13 shows the minimum spanning tree generated by the Kruskal algorithm, it can be seen from the figure that the whole network is in the connected state.

Fig. 14 shows the comparison of WSN deployment optimization corresponding to the five algorithms with the same experimental parameters. As can be seen from the figure, the network coverage rate optimized by FPA is 93.57%,

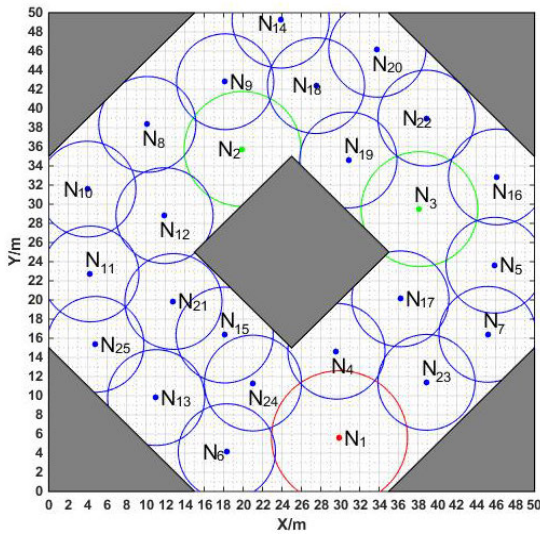

FIGURE 11. Deploying WSN after optimization.

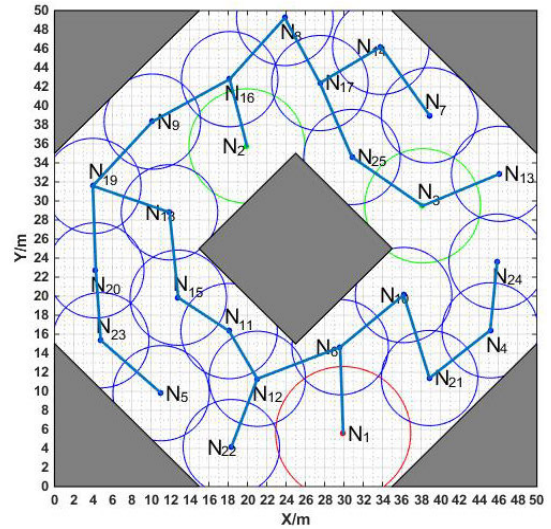

FIGURE 13. Final deployment WSN.

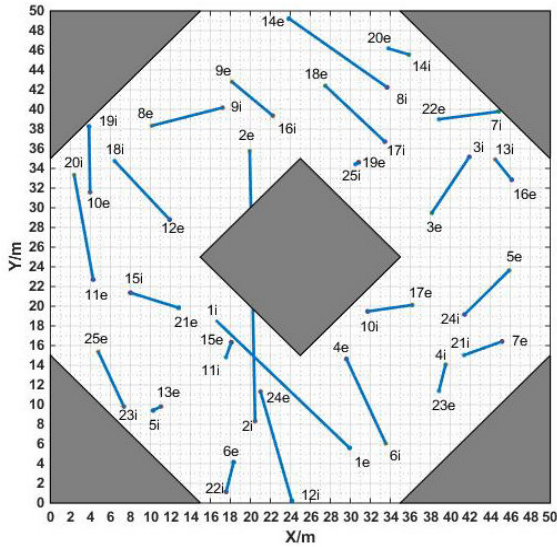

FIGURE 12. Optimal assignment.

while that optimized by IFPA is higher, reaching 94.25% on average, 0.68% higher than that optimized by FPA, and also higher than that optimized by the other three algorithms. This is because the greedy crossover strategy in IFPA enables a poorer set of nodes to receive a portion of the nodes from a better set of nodes, by using the current optimal set of deployment plan to assist other deployment plans to deploy the network, and the coverage of poor deployment plans is improved. Before the 20th generation, all the algorithms converge faster, the GA with elite strategy has a faster convergence rate in the early stage, but the latter has a slower convergence rate and lower precision due to the decrease of population diversity. However, the PSO converges faster in the early stage, but it falls into the local optimum in later iterations, and has completely converged around 120 generations. The network coverage rate of PSO deployment is 92.39%,

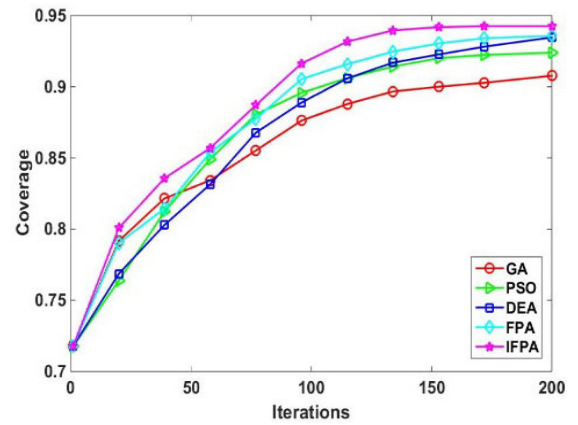

FIGURE 14. Coverage comparison.

which is 1.86% lower than IFPA. This shows that the PSO that performs well in [8] is not prominent in the deployment environment and model of this paper. DEA, FA and IFPA are based on greedy strategies, which make each iteration retain the best deployment plan, after the 20th generation, IFPA has better coverage than FPA and DEA in each generation due to the role of Tent map strategy, which generates new nodes with chaotic maps and replaces some nodes in a set of plans, so that the populations still maintain diversity in the later iterations. This strategy strengthens the ability of the algorithm to jump out of local optimum, and make the best coverage for each iteration better than FPA and DEA. From the figure, we can see that IFPA has completely converged in about 180 generations, and the other three algorithms are converging in addition to PSO, thus verifying the validity of our proposed convergence factor.

Fig. 15 shows the coverage comparison of five algorithms with different number of nodes. When the number of nodes is 45, the IFPA deployment plan can achieve 100% coverage of the entire monitoring area, whereas other algorithms require

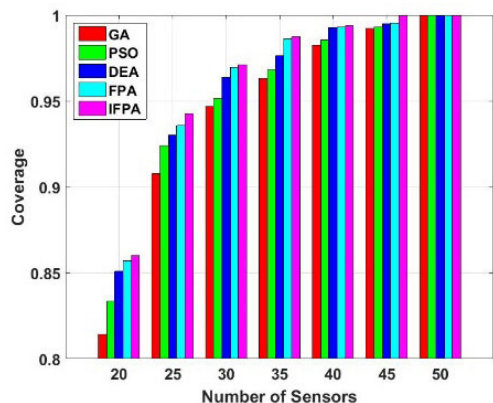

FIGURE 15. Number of nodes and coverage.

50 nodes. Overall IFPA’s WSN coverage performance is better than the other four algorithms, so the number of nodes required for deployment is less under the same coverage requirement, thus saving the deployment costs. It can also be seen from the figure that with the increase of the number of nodes, the coverage rate of each algorithm increases slowly, this is because the number of nodes is too large, which leads to redundancy and the optimization efficiency decreases. Between 20 nodes and 30 nodes, the coverage rate growth is the fastest, this is because the number of nodes is less, resulting in more coverage holes. Therefore, the increase of the number of nodes at this stage brings the greatest deployment benefit and significant effect. Taking GA as an example, when the number of nodes is 20, the coverage rate is 81.43%, and at 25, it reaches 90.77%, which is a full increase of 9.34%.

B. EXPERIMENT 2: MULTI-OBJECTIVE WSN DEPLOYMENT

In order to optimize the coverage rate, radiation overflow rate and energy consumption rate of WSN, we design the experiment as follows. According to the area of the monitoring range and the maximum coverage of each node, we can calculate that when the number of nodes is 25, the WSN can theoretically cover the entire monitoring area. There are 3 types of sensor nodes, the perception radius is 5m, 6m and 7m respectively, and the power of the corresponding battery is 80mw, 90mw and 100mw. Also, we chose the NSGAIL of [13] and the MODEA deployment method of [14] to compare with the NSMOFPA, and other comparison methods can be found in Table 4. The number of weight groups of MODEA and MOFPA is 200, the number of iterations is 200, and the number of search agents is 50. The number of search agents and iterations of NSGAIL, MOPSO and NSMOFPA are 200 and 500 respectively. The monitoring area of experiments is a polygon, and the type of obstacles is rectangular. Specific experimental parameters are shown in Table 6, and Table 7 lists the meanings and values of some symbols in the WSN.

Fig.16 shows the Pareto Front for NSGAIL, MOPSO, MODEA, MOFPA, and NSMOFPA respectively. The f1, f2 and f3 are the network coverage rate, node radiation

TABLE 6. Experimental parameter settings.

Monitoring area shape	Area size (m ²)	Obstacle shape	Radius is 7	Radius is 6	Radius is 5
Polygon	1700	rectangle	1	2	22

overflow rate and energy consumption rate respectively. It can be seen from the figure that the pareto front of the three algorithms based on non-dominant sorting is more uniform, and the MODEA and MOFPA based on linear weighted sum have uneven distribution on the front, most of which are concentrated in one area and have more scattered points.

In order to more clearly know the changes of the three optimization objectives, the convergence performance of the algorithm and the average level of the optimal solution, we separately analyze the three optimization objectives. Since the five algorithms have two methods to solve the multi-objective optimization problem, the algorithms of the same solution method will be compared together. Fig. 17 (a-c) depicts the average fitness of the population for each iteration of NSGAIL, MOPSO and NSMOFPA. It can be seen from the figure that before the 50th generation, the performance gap between the three is not obvious. But in the later stage, the search efficiency decreases as the diversity of the population decreases. Thus, the final result of MOPSO is worse than NSMOFPA. Whereas NSGAIL and NSMOFPA adopt elite strategy, NSGAIL is relatively based on blind search, which leads to slower convergence. At the end of iteration, there is no convergence trend. NSMOFPA with elite strategy is better than NSGAIL. Because the leader strategy adopted can guide the solution set to approach the current optimal solution set, and at the end of the iteration, it tends to converge. In addition, because the crowding degree strategy maintains the diversity of the solution population, NSMOFPA does not fall into convergence as early as MOPSO, and the algorithm can still be effectively performed, so the average level of the solution set is better than the other two algorithms. Taking f1 (coverage rate) as an example, the coverage rate of NSMOFPA optimized solution set is 89.79% on average, 0.94% higher than 88.85% of MOPSO and 2.00% higher than 87.79% of NSGAIL. Fig. 17 (d-f) depicts a comparison of the MODEA and MOFPA algorithms in a linear weighted summation on three optimization objectives. Experiments performed by the two algorithms with the same weight, after the completion of each group weight experiment, the population average fitness value of each optimization objective is saved. From Fig. 17 (d-e), it can be seen that the average convergence precision of MOFPA is better than that of the MODEA under most weight tests. Taking the optimal coverage as an example, due to the Levy distribution strategy added by MOFPA, compared with MODEA, MOFPA has more flexible random steps and richer diversity, so the average level of MOFPA solution is always better than MODEA, but there are exceptions. In most cases, MODEA is better than MOFPA in energy consumption optimization. At the same time, it can be

TABLE 7. Meaning and value of symbols.

Symbol	Description	Value
η	Perceived energy consumed per square meter	0.0003(mw/m ²)
k	Length of data sent and received	100bit
E_{cler}	Energy Consumption for Sending 1 bit data	0.000005mw
E_{cler}	Energy Consumption for Receiving 1 bit data	0.000005mw
τ	Energy consumption of noise	0.00005mw
l	The energy consumed by node moving 1 meter	0.0002mw

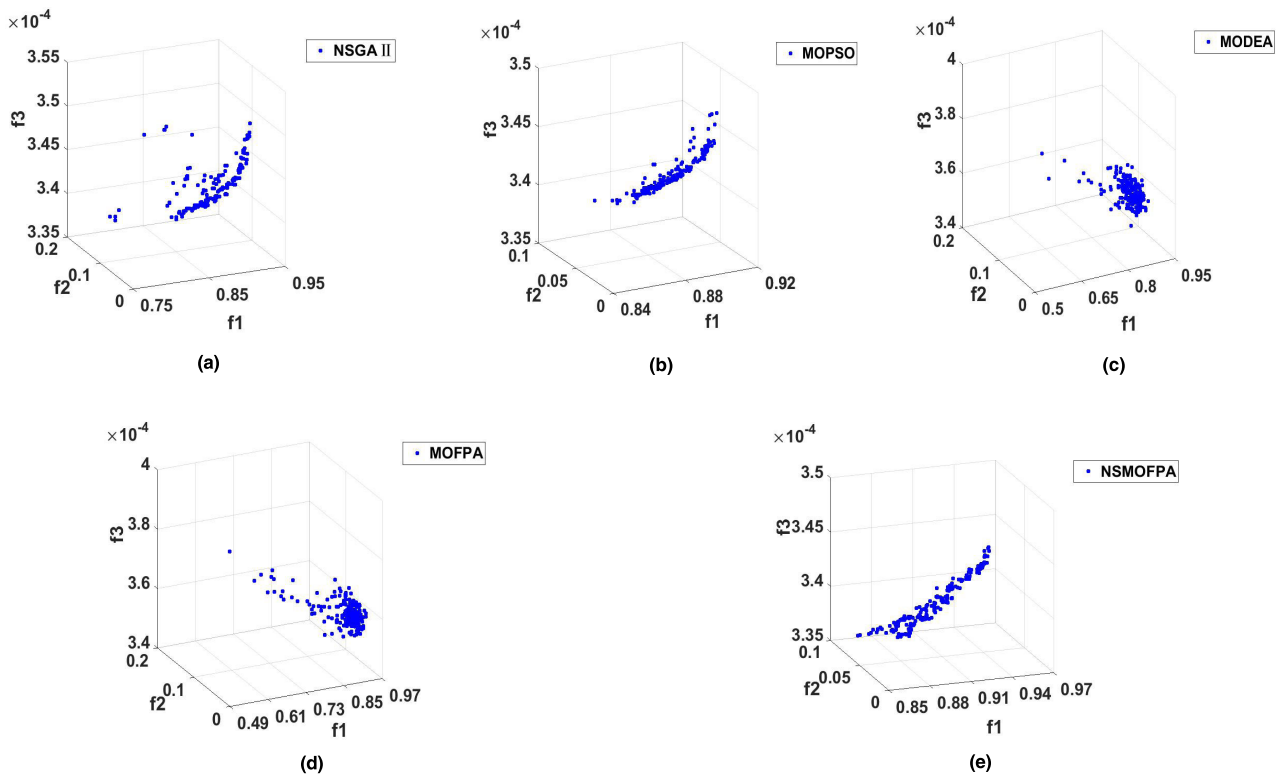

FIGURE 16. Pareto Front of 5 algorithms.

seen from the figure that with the increase of the weight value, the effect of the optimization objective seems to be a positive correlation change. Taking the node radiation overflow rate as an example, with the increase of weight, the difference between optimization results of the two algorithms tend to be smaller and smaller, in other words, the optimization effect is getting better and better.

In order to compare the precision of the solution of the five multi-objective optimization algorithms and the uniformity of the solution, the solution set optimized by the algorithm is showed in the form of boxplot diagram. Fig. 18 is a boxplot

of the optimal solution set for the five algorithms. In the precision performance evaluation of the solution set, MOFPA and MODEA performed outstandingly in the coverage optimization, reaching 92.91% and 90.06% respectively. In terms of node radiation overflow rate, MOFPA performed well, MODEA was the worst, and for the performance in terms of energy consumption rate, both are poor. NSMOFPA benefits from two optimization strategies. Greedy crossover strategy is to optimize with independent deployment plan, its steps are that the worse deployment plan obtains some nodes from any deployment plan, then obtains some nodes from the better

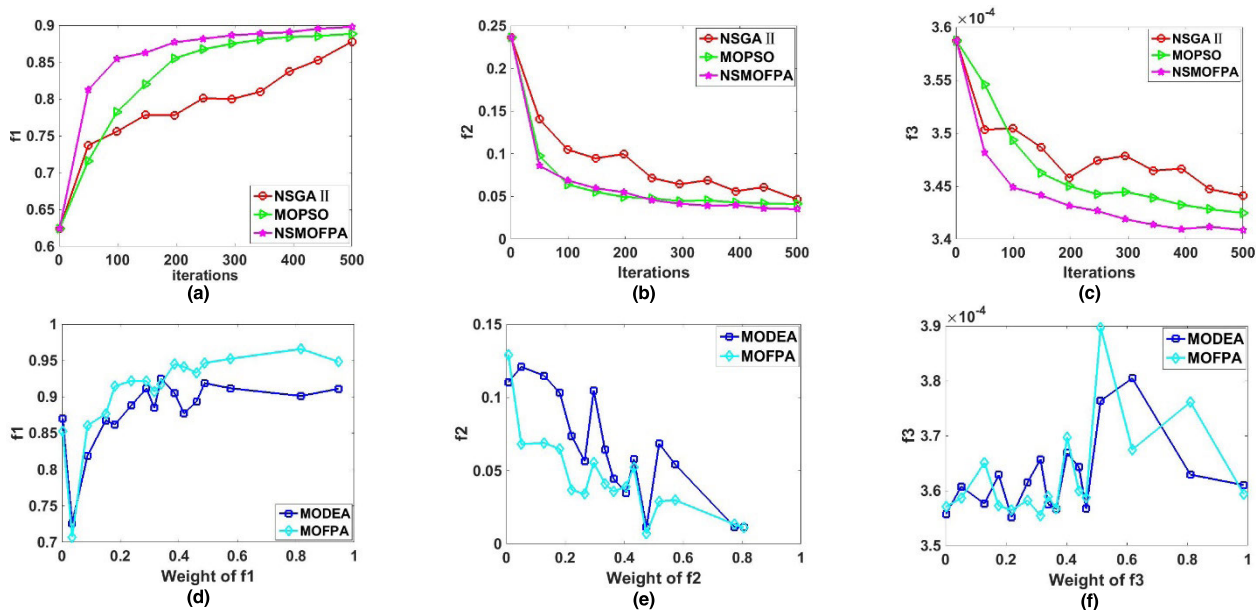

FIGURE 17. Population convergence of 5 algorithms.

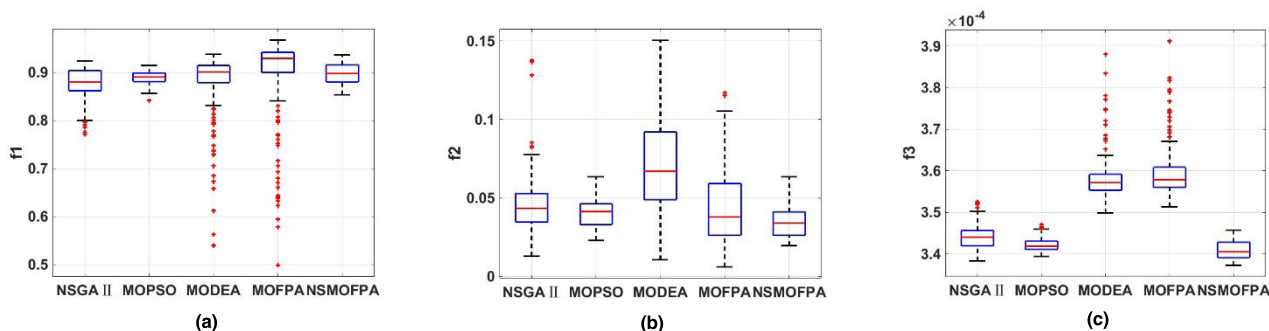

FIGURE 18. Boxplot of the optimal solution set.

deployment plan, and the better plan leads the worse scheme to optimize. On the other hand, the elite strategy takes the deployment plan set as the optimization goal, the parents and the children compete for the opportunity to enter the next iteration, which ensures that the better deployment plan not to be destroyed during the iteration, and at the same time the deployment plan set has higher precision. Therefore, the average precision of NSMOFPA is better in coverage, radiation overflow rate and energy consumption rate. The average coverage rate of NSMOFPA is 89.77%, 1.77% higher than that of the worst NSGAIL, the node radiation overflow rate of NSMOFPA is 3.4%, which is 3.3% lower than the worst MODEA, and the network energy consumption rate of NSMOFPA is 0.034%, which is 0.002% lower than the worst MOFPA. The performance of MOPSO and NSGAIL is relatively stable, and MOPSO is still better than NSGAIL. In terms of the uniformity of the solution, it can be seen from the figure that MODEA, MOFPA, and NSGAIL perform poorly, not only the height of the box is high, but also

there are many outliers. This phenomenon shows that the data fluctuates greatly. Taking the optimized coverage rate as an example, the average coverage of MOFPA is 92.91%, the lowest is 49.82, and the difference is 43.09%, which is extremely uneven. MOPSO performs better, all boxes in MOPSO have the lowest height, but the fly in the ointment is that there are any outliers. It shows that most of the data in MOPSO is more uniform, but there are still uneven solutions. NSMOFPA benefits from the crowding degree strategy, which enables individuals with larger crowding values to remain and enter the next iteration with greater probability. Thus maintaining the diversity of the population in the solution set, which is the basis for the uniformity of the solution set. The archive and leader strategy is to lead the remaining individuals in the population to approach the optimal solution set and improve the uniformity of the solution set, so that the average coverage rate of NSMOFPA can reach 89.77%, with a minimum of 85.35%, which is relatively uniform overall. It can be seen from the above experimental results

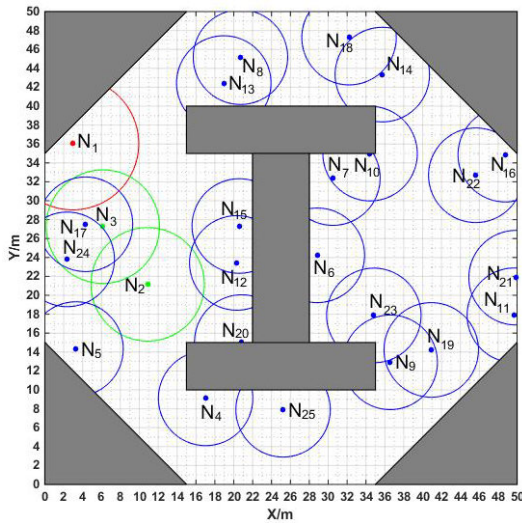

FIGURE 19. Initial deployment WSN.

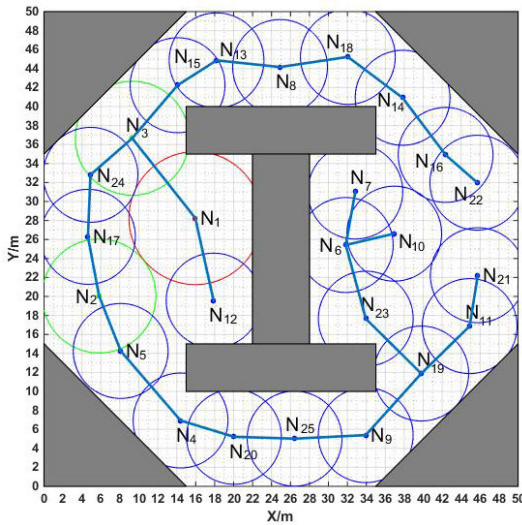

FIGURE 20. Final deployment WSN.

that NSMOFPA is one of the better performing algorithms in both the precision and uniformity of the solution set. In addition, the results showed that NSGAI and MODEA did not performed well in the deployment model considered in this paper.

Fig. 19 shows the effect of random deployment. The network coverage rate reaches 67.12%, and the node radiation overflow rate is 26.50%. Because the network is not connected and there are many coverage holes, the network cannot work normally. Fig. 20 is a solution in Pareto solution set, the coverage rate of the deployment plan reaches 93.88%, which is 26.76% higher than the initial deployment. At this time, the whole network is connected, and the node radiation overflow rate is 4.97%, which is 21.53% lower than the initial deployment. The energy consumption rate is 0.0345%, and the deployment effect is remarkable.

In summary, we have compared the performances of our proposed algorithm and several other well known algorithms. In the first experiment, when five single-objective optimization algorithms are applied to the network deployment with network coverage optimization goals, IFPA has excellent performance in the monitoring area with diamond obstacles, the greedy cross strategy and convergence factor have made a great contribution to this. The second experiment is to apply five multi-objective optimization algorithms to the WSN deployment with network coverage, node radiation overflow rate and energy consumption rate as optimization goals. We evaluated the convergence performance of the algorithm by the convergence curve on each optimization objective, and the boxplots showed the average precision and uniformity of the solution set. Due to the elite strategy, the archive strategy and several strategies mentioned in the paper, NSMOFPA has a good performance in the convergence, precision and uniformity of the solution, and it is the most balanced algorithm among the compared algorithms. There is an interesting phenomenon in the experimental results, the two algorithms based on the linear weighted sum method have a poor optimization effect on the energy consumption rate. It may be because the value of energy consumption rate is too small. Although it has been normalized, it is three orders of magnitude smaller than network coverage and node radiation overflow rate, and the coverage value is larger, so it is dominant in the three optimization objectives, which is also the reason for the best coverage optimization effect.

VIII. CONCLUSION AND FUTURE WORKS

In order to solve the problem of deploying heterogeneous wireless sensor network nodes in monitoring areas with obstacles in various circumstances (urban deployment and forest deployment), the first half of this paper proposes an IFPA for urban WSN deployment. Firstly, the Tent map is used to initialize the population, which enriches the population diversity. When the population diversity is weak in the later iterations, the Tent map can generate the mapping sequence and replace some of the individual variables in the original population, thus maintaining the diversity of the population. Secondly, the nonlinear convergence factor of the design modifies the scaling factor of the original algorithm, so that the step size changes nonlinearly, which promotes the global search of the algorithm, thus improving the convergence ability of the algorithm. Thirdly, the steps of greedy crossover strategy are to obtain partial variables from neighboring individuals and superior individuals by crossover and replacement respectively. It has the effect of optimizing the other individuals with superior individuals, which can improve the precision of the solution. Finally, the simulation results of WSN deployment show that IFPA improves the coverage performance of WSN. In the deployment environment with obstacles, IFPA can achieve the same coverage requirement with fewer nodes than other optimization algorithms, reducing the network's deployment costs. In the second half of this paper, the network coverage,

radiation overflow rate and energy consumption rate of nodes are taken as optimization objectives, for WSNs deployed in forest environment and simulated. Aiming at this deployment problem, we have proposed NSMOFPA. Firstly, we introduced the archive strategy and the leader strategy to solve the global pollination problem of the multi-objective flower pollination algorithm. At the same time, the current optimal part of the individual leads the remaining individuals to approach it, making the solution set more uniform. Secondly, the proposed greedy cross strategy is used to guide the individual's optimization in the population, which can improve the precision of the solution. Thirdly, the introduction of elite strategy makes the superior individuals in the parent generation not to be destroyed during iterations, so the convergence performance of the algorithm can be improved. To avoid the loss of population diversity, a strategy for calculating the degree of crowding is proposed. Finally, simulation experiments of WSN deployment with obstacles have been carried out, with network coverage, radiation overflow rate and energy consumption rate as optimization objectives. Compared with the other four algorithms, NSMOFPA can provide a deployment solution set with higher average coverage, lowest average node radiation overflow rate and lowest average energy consumption rate. Then we have analyzed the convergence of the population and the boxplot of the optimal solution set, which verified that NSMOFPA has excellent convergence performance and superior uniformity. On the whole, NSMOFPA is the most balanced algorithm in terms of the precision of the solution set, the uniformity of the solution set and the convergence of the algorithm, it can provide a better solution for WSN deployment. In the future, we will study the field of deploying sensor nodes on 3D surfaces.

REFERENCES

- [1] B. Mohieddine, A. Abderrazak, and A. Sabbir, "A modular IoT platform for real-time indoor air quality monitoring," *Sensors*, vol. 18, no. 2, pp. 568–581, Feb. 2018.
- [2] Y. Li, C. S. Chen, and K. Chi, "Two-tiered relay node placement for WSN-based home health monitoring system," *Peer-to-Peer Netw. Appl.*, vol. 12, no. 3, pp. 589–603, Feb. 2018.
- [3] M. Li and H. J. Lin, "Design and implementation of smart home control systems based on wireless sensor networks and power line communications," *IEEE Trans. Ind. Electron.*, vol. 62, no. 7, pp. 4430–4442, Jul. 2015.
- [4] C. Zhu, V. C. M. Leung, and L. T. Yang, "Collaborative location-based sleep scheduling for wireless sensor networks integrated with mobile cloud computing," *IEEE Trans. Comput.*, vol. 64, no. 7, pp. 1844–1856, Jul. 2014.
- [5] H. Li and Z. Lin, "Study on location of wireless sensor network node in forest environment," *Procedia Comput. Sci.*, to be published, doi: [10.1016/j.procs.2017.03.150](https://doi.org/10.1016/j.procs.2017.03.150).
- [6] A. Ghosh and N. Chakraborty, "A novel residual energy based distributed clustering and routing approach for performance study of wireless sensor network," *Int. J. Commun. Syst.*, to be published, doi: [10.1002/dac.3921](https://doi.org/10.1002/dac.3921).
- [7] S. Mini, S. K. Udgata, and S. L. Sabat, "Sensor deployment and scheduling for target coverage problem in wireless sensor networks," *IEEE Sensors J.*, vol. 14, no. 3, pp. 636–644, Mar. 2014.
- [8] C. Cong, "A coverage algorithm for WSN based on the improved PSO," in *Proc. Int. Conf. Intell. Transp., Big Data Smart City*, Halong Bay, QN, Vietnam, 2015, pp. 12–15.
- [9] X. Y. Z. Deng and R. Tang, "An optimized node deployment solution based on a virtual spring force algorithm for wireless sensor network applications," *Sensors*, vol. 19, no. 8, pp. 1817–1831, Apr. 2019.
- [10] N. Qin and J. Xu, "An adaptive fish swarm-based mobile coverage in WSNs," *Wireless Commun. Mobile Comput.*, to be published, doi: [10.1155/2018/7815257](https://doi.org/10.1155/2018/7815257).
- [11] R. Tang, Z. Chen, and Z. Liu, "Investigation of the shielding length on yukawa system crystallization in mobile sensor network applications," *IEEE Trans. Plasma Sci.*, vol. 44, no. 6, pp. 1025–1031, Jun. 2016.
- [12] A. V. Gonzalez, L. Brisolaro, and P. R. Ferreira, "Efficiency evaluation of strategies for dynamic management of wireless sensor networks," *Wireless Commun. Mobile Comput.*, to be published, doi: [10.1155/2017/5618065](https://doi.org/10.1155/2017/5618065).
- [13] M. A. Benatia and M. B. D. Sahnoun, "Multi-objective WSN deployment using genetic algorithms under cost, coverage, and connectivity constraints," *Wireless Pers. Commun.*, vol. 94, no. 4, pp. 2739–2768, Feb. 2017.
- [14] A. Céspedes-Mota, G. Castanon, and A. F. Martínez-Herrera, "Differential evolution algorithm applied to wireless sensor distribution on different geometric shapes with area and energy optimization," *J. Netw. Comput. Appl.*, to be published, doi: [10.1016/j.jnca.2018.06.006](https://doi.org/10.1016/j.jnca.2018.06.006).
- [15] L. Wang, W. H. Wu, and J. Y. Qi, "Wireless sensor networks coverage optimization based on whale group algorithm," *Comput. Sci. Inf. Syst.*, vol. 15, no. 3, pp. 569–583, Oct. 2018.
- [16] Y. Xu, O. Ding, and R. Qu, "Hybrid multi-objective evolutionary algorithms based on decomposition for wireless sensor network coverage optimization," *Appl. Soft Comput.*, to be published, doi: [10.1016/j.asoc.2018.03.053](https://doi.org/10.1016/j.asoc.2018.03.053).
- [17] X. Shen, J. Li, and Q. Zhang, "WSN coverage hierarchical optimization method based on the improved MOEA/D," *Metall. Mining Ind.*, vol. 2015, no. 6, pp. 348–354, Feb. 2015.
- [18] X. S. Yang, "Flower pollination algorithm for global optimization," *Unconventional Comput. Natural Comput.*, to be published, doi: [10.1007/978-3-642-32894-7_27](https://doi.org/10.1007/978-3-642-32894-7_27).
- [19] W. Xu, Z. Ji, and Y. Wang, "A flower pollination algorithm for flexible job shop scheduling with fuzzy processing time," *Modern Phys. Lett. B*, vol. 32, no. 34, pp. 1840113–1840119, Dec. 2018.
- [20] O. Abdel-Raouf, I. El-Henawy, M. Abdel-Baset, "A novel hybrid flower pollination algorithm with chaotic harmony search for solving sudoku puzzles," *Int. J. Modern Edu. Comput. Sci.*, vol. 6, no. 6, pp. 38–44, Mar. 2014.
- [21] C. Shilaja and K. Ravi, "Optimization of emission/economic dispatch using Euclidean affine flower pollination algorithm (eFPA) and binary FPA (BFPA) in solar photo voltaic generation," *Renew. Energy*, vol. 2017, no. 107, pp. 550–566, Jul. 2017.
- [22] E. Barocio, J. Regalado, E. Cuevas, F. Uribe, P. Zúñiga, and P. J. R. Torres, "Modified bio-inspired optimisation algorithm with a centroid decision making approach for solving a multi-objective optimal power flow problem," *IET Gener., Transmiss. Distrib.*, vol. 11, no. 4, pp. 1012–1022, Mar. 2017.
- [23] R. Peesapati, V. K. Yadav, and N. Kumar, "Flower pollination algorithm based multi-objective congestion management considering optimal capacities of distributed generations," *Energy*, to be published, doi: [10.1016/j.energy.2018.01.077](https://doi.org/10.1016/j.energy.2018.01.077).
- [24] K. Wang, X. Li, and L. Gao, "A multi-objective discrete flower pollination algorithm for stochastic two-sided partial disassembly line balancing problem," *Comput. Ind. Eng.*, vol. 2019, no. 130, pp. 634–649, Apr. 2019.
- [25] X. S. Yang and M. H. X. Karamanoglu, "Flower pollination algorithm: A novel approach for multi-objective optimization," *Eng. Optim.*, vol. 46, no. 9, pp. 1222–1237, May 2014.
- [26] V. K. Verma, S. Singh, and N. P. Pathak, "Comprehensive event based estimation of sensor node distribution strategies using classical flooding routing protocol in wireless sensor networks," *Wireless Netw.*, vol. 20, no. 8, pp. 2349–2357, Jun. 2014.
- [27] R. Jonker and A. Volgenant, "A shortest augmenting path algorithm for dense and sparse linear assignment problems," *Computing*, vol. 38, no. 4, pp. 325–340, Nov. 1987.
- [28] N. Sharmin, E. Olivetti, and P. Avesani, "White matter tract segmentation as multiple linear assignment problems," *Front Neurosci.*, to be published, doi: [10.3389/fnins.2017.00754](https://doi.org/10.3389/fnins.2017.00754).
- [29] M. Mesbahi and M. Egerstedt, Eds., *Graph Theoretic Methods in Multiagent Networks*. Princeton, NJ, USA: Univ. Princeton Press, 2010. [Online]. Available: <https://pdfs.semanticscholar.org/7208/0c14258cf8ca884329d50fdbe51790670b5a.pdf>
- [30] Y. Zhou, J. Wu, and Q. Chen, "Kruskal algorithm based assessment on power system structural vulnerability," *Power Syst. Technol.*, vol. 37, no. 11, pp. 3172–3177, Nov. 2013.

- [31] H. Xu, X. Qian, and L. Zhang, "Study of ACO algorithm optimization based on improved tent chaotic mapping," *J. Inf. Comput. Sci.*, vol. 9, no. 9, pp. 1653–1660, Jun. 2012.
- [32] T. E. Toreini and M. Mehrnejad, "A novel method in fuzzy data clustering based on chaotic PSO," in *Proc. Int. Conf. for Internet Technol. Secured Trans.*, Abu Dhabi, United Arab Emirates, 2011, pp. 335–340.
- [33] G. Kaur and S. Arora, "Chaotic whale optimization algorithm," *J. Comput. Des. Eng.*, vol. 5, no. 3, pp. 275–284, Jan. 2018.
- [34] C. W. Ahn and R. S. Ramakrishna, "Elitism-based compact genetic algorithms," *IEEE Trans. Evol. Comput.*, vol. 7, no. 4, pp. 367–385, Aug. 2003.
- [35] C. A. C. Coello, G. T. Pulido, and M. S. Lechuga, "Handling multiple objectives with particle swarm optimization," *IEEE Trans. Evol. Comput.*, vol. 8, no. 3, pp. 256–279, Jun. 2004.
- [36] K. Deb, A. Pratap, S. Agarwal, and T. Meyarivan, "A fast and elitist multiobjective genetic algorithm: NSGA-II," *IEEE Trans. Evol. Comput.*, vol. 6, no. 2, pp. 182–197, Apr. 2002.
- [37] W. Qian, J. Chai, Z. Xu, and Z. Zhang, "Differential evolution algorithm with multiple mutation strategies based on roulette wheel selection," *Appl. Intell.*, vol. 48, no. 10, pp. 3612–3629, Apr. 2018.

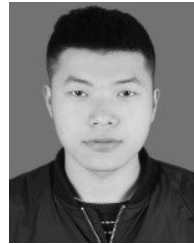

HUAMAO XIE received the B.S. degree in electronic information science and technology from Shangrao Normal University, in 2017. He is currently pursuing the M.S. degree with the Jiangxi University of Science and Technology. His main research interests include wireless sensor network deployment and group intelligence optimization algorithms.



DAOJING HE (S'07–M'13) received the B.Eng. and M. Eng. degrees in computer science from the Harbin Institute of Technology, China, in 2007 and 2009, respectively, and the Ph.D. degree in computer science from Zhejiang University, China, in 2012. He is currently a Professor with the School of Computer Science and Software Engineering, East China Normal University. His research interests include network and systems security. He is on the Editorial Board of international journals such as the *IEEE Communications Magazine* and *IEEE Network*.



ZHENDONG WANG received the Ph.D. degree from Harbin Engineering University. He is currently an Associate Professor with the Jiangxi University of Science and Technology. He has published more than ten academic articles in various journals or academic conferences. He has strong research capabilities. He has hosted several national natural science fund projects and provincial fund projects. His main research interests include wireless sensor networks and network security.



SAMMY CHAN (S'87–M'89) received the B.E. and M.Eng.Sc. degrees in electrical engineering from the University of Melbourne, Australia, in 1988 and 1990, respectively, and the Ph.D. degree in communication engineering from the Royal Melbourne Institute of Technology, Australia, in 1995. Since December 1994, he has been with the Department of Electronic Engineering, City University of Hong Kong, where he is currently an Associate Professor.

• • •