

Received October 21, 2019, accepted November 2, 2019, date of publication November 8, 2019, date of current version November 21, 2019.

Digital Object Identifier 10.1109/ACCESS.2019.2951750

A Survey of Deep Learning Techniques: Application in Wind and Solar Energy Resources

SHAHAB SHAMSHIRBAND¹, TIMON RABZUK², AND KWOK-WING CHAU³

¹Department of Computer Science, Norwegian University of Science and Technology, 7491 Trondheim, Norway

²Institute of Structural Mechanics, Bauhaus University Weimar, 99423 Weimar, Germany

³Department of Civil and Environmental Engineering, The Hong Kong Polytechnic University, Hong Kong

Corresponding author: Shahab Shamshirband (shahab.shamshirband@ntnu.no)

This work was supported by Norwegian Open Artificial Intelligence Lab, Department of Computer Science, NTNU, Trondheim, Norway.

ABSTRACT Nowadays, learning-based modeling system is adopted to establish an accurate prediction model for renewable energy resources. Computational Intelligence (CI) methods have become significant tools in production and optimization of renewable energies. The complexity of this type of energy lies in its coverage of large volumes of data and variables which have to be analyzed carefully. The present study discusses different types of Deep Learning (DL) algorithms applied in the field of solar and wind energy resources and evaluates their performance through a novel taxonomy. It also presents a comprehensive state-of-the-art of the literature leading to an assessment and performance evaluation of DL techniques as well as a discussion about major challenges and opportunities for comprehensive research. Based on results, differences on accuracy, robustness, precision values as well as the generalization ability are the most common challenges for the employment of DL techniques. In case of big dataset, the performance of DL techniques is significantly higher than that for other CI techniques. However, using and developing hybrid DL techniques with other optimization techniques in order to improve and optimize the structure of the techniques is preferably emphasized. In all cases, hybrid networks have better performance compared with single networks, because hybrid techniques take the advantages of two or more methods for preparing an accurate prediction. It is recommended to use hybrid methods in DL techniques.

INDEX TERMS Big dataset, deep learning, modeling, optimizing, solar energy, wind energy.

ACRONYMS USED FREQUENTLY IN THIS WORK

GHG	Greenhouse gas
LSTM	Long short-term memory Network
FL	Fuzzy logic
SAE	Stacked auto-encoder
DL	Deep learning
DRL	Deep reinforcement learning
CI	Computational intelligent
WNN	wavelet neural network
DBN	Deep belief network
DRWNN	diagonal recurrent wavelet neural network
RBM	Restricted Boltzmann machine
ANFIS	Adaptive neuro fuzzy inference system

RBF	Radial basis function
EC	Evolutionary computation
CNN	Convolutional neural network
MLP	Multi layered perceptron
TDNN	Time delay neural network
NARNN	Nonlinear auto regressive neural network
FFNN	Feed-forward neural network
CPRS	Continuous ranking probability score (
ANNs	Artificial neural networks
SVM	Support vector machine
MRBM	Multilayer Restricted Boltzmann Machine
BPNN	Back Propagation Neural Network
WT	Wavelet transform
QR	Quintile regression

The associate editor coordinating the review of this manuscript and approving it for publication was Ton Do¹.

SVR	Support vector regression
DNN-MRT	Deep Neural Network-Meta Regression Transfer
RMSE	Root mean squared error
MAE	Mean absolute error
SDE	Standard deviation error
RMT	Random Matrix Theory
RNN	Recurrent Neural Network
PR	Persistence model
SML	Stochastic maximum likelihood
MCMC	Markov chain monte carlo

I. INTRODUCTION

Vast progress in science and technology improved the comfort of human life tremendously. However, it generates environmental risks and energy crisis such as increasing environmental pollutants and reducing energy resources, which are considered as threats to the human life [1]. Utilization of renewable energies [2], [3] (such as biofuels, wind and solar energies) together with energy management [4] is one of the solutions to deal with these threats. Heavy dependence on fossil fuel and limited refinement of nature as well as mismanagement of waste sources have caused environmental crisis [5], [6]. As an example, fossil fuel for economic activities leads to greenhouse gases (GHG) emissions all over the world [7]. Increasing GHG renders an increase in the average temperature of the earth's surface [8].

These phenomena led governments and scientists to exploit renewable energies. Renewable energy sources turn to be considered as an alternative energy supplier in the future's energy systems, especially when the issues of greenhouse gas emissions become important crisis to human life [9]. Renewable energies have different sources including solar, wind, biomass, hydropower, geothermal and hydrogen energies [10]–[15]. There are various studies in the field of renewable energies as alternative energy sources to fossil energy. Ashok *et al.* [16] studied lemon fruit rinds as a biodegradable source of energy exploitation to find its suitability for internal combustion engines. Malik and Sukhera [17] studied future energy productions, demands and supply from natural gas in Pakistan by considering economic and environmental crisis with the aim of natural gas management and search for alternative renewable energy resources. In a study by Yusaf *et al.* [18], the potential of renewable sources in Australia was investigated with the aims of regulating the use of conventional energies and trying to use renewable energies as alternative sources. This would reduce world-wide GHG emissions. Cristina [19] considered the potential of renewable energies as energy sources for electricity and heating uses in rural areas of Romania due to lack of electricity in some urban areas of this country. Renewable energy (green energy) could be a sustainable solution to living quality improvement in this area.

Up to date, many researchers employed different modeling methods and tried to establish an accurate and recognized model in this field by using various information [20], [21].

However, some modeling approaches such as linear or non-linear regression mathematical models may not be applicable for practical complex prediction tasks due to high amount of computational costs [22], [23]. Mathematical models are simple and easy to use but, in some cases, (depending on data) cannot include all aspects of the problem and only work in certain situations. Due to the nature of clean energy data and interrelationships of data, using mathematical models cannot reach high accuracy, yet requires large number of coefficients and complex computations [3], [23], [24].

Computational Intelligence (CI) methods are known as essential tools which have been successfully applied to improve the performance of energy systems in both production and transfer. In this way, a wide range of energy production systems such as renewable energy systems are highly reliant on the advancement of CI techniques. Big data in renewable energy systems have created a considerable number of opportunities and challenges for decision-making, estimation and optimization in wind and solar energy systems. Accordingly, in order to perform an effective research in this field, there is a need for the utilization of high-performance modeling methods with a simple application. Therefore, CI methods have reached an important place in the fields of production, optimization and evaluation of renewable energies due to the generation complexity of this type of energy covering large volumes of data and variables, which have to be analyzed carefully in order to extract energy in real energy systems. ANNs, EC, FL and probabilistic methods are four main principles of CI methods. Prediction systems contribute to generate comprehensive system that can be used in further studies [21], [25]. Intelligent prediction models do not need complex mathematical relationships of systems. In recent years, these methods were used in all fields of science [20]. Faizollahzadeh Ardabili *et al.* developed a study to manage and classify CI techniques developed in the field of hydrogen production. Accordingly, the prediction of the process of producing energy in renewable energy systems helps to design energy and power control systems, choose energy systems and utilize energy management systems.

Recently, there were several surveys on applications of CI methods in renewable energies. Khatib *et al.* [26] reviewed applied modeling techniques in the field of solar energy. The examined models included linear, nonlinear, and artificial intelligence models. Based on literature review, the most correlated variables on solar energy are sunshine ratio and ambient temperature.

Qazi *et al.* [27] reviewed the application of ANNs in the prediction of solar radiation. Based on their results, artificial neural networks had high flexibility and could perform modeling tasks with many weather parameters as inputs, which resulted in a more accurate and reliable network, compared to other empirical models.

In another study by Voyant *et al.* [28], the prediction of solar irradiation by using machine learning methods were studied. They found that ML methods (such as nearest-neighbor neural network and Bootstrap aggregating)

improved the prediction performance and accuracy. Ata [29] applied MLP network to forecast wind energy. Almonacid *et al.* [30] performed a review survey on ANNs applying to low and high concentrator photovoltaic in predicting the main parameters which affected the performance of concentrator photovoltaic systems that were operating outdoors.

Based on our best knowledge and according to what has been reported in various studies, a single CI technique such as ANN, Fuzzy, SVM, or hybrid CI technique such as ANFIS, in cases where the volume of data is large and requires the modeling of the process of trends, cannot have an admirable precision and cannot meet the demands of the operator. In this context, novel methods have emerged to address them. A set of them are categorized as DL techniques DL technique is referred to a deep architecture of ANNs with large-scale data processing capabilities [31]. These algorithms can learn imagination and differentiate features in a hierarchical method from the data [32]. DBNs, RBMs, CNNs, RNNs or LSTMs, SAE and DRL are known methods of DL. Recently, DL algorithms were applied to different fields of renewable energy, providing high prediction accuracy for solar and wind energy compared to traditional methods. Therefore, it motivates us to investigate different architecture of DL applied in these two renewable energy fields.

Recent studies have been developed to categorize different DL techniques. Akbaba *et al.* [33] employed DL technique for the estimation of horizontal daily solar irradiation in comparison with classic prediction models. Nagem *et al.* [34] were the first in employing DL techniques for the estimation of solar storms using Geostationary Operational Environmental Satellite data. Aakroum *et al.* [35] employed DL technique for the prediction of surface solar irradiation. Muhammad [36] employed DL technique for the prediction of hourly, daily and yearly solar irradiation.

Tao *et al.* [37] employed DL technique for the prediction of wind power in the presence of historical data. de Aquino *et al.* [38] employed DL technique for the prediction of wind power generation with high accuracy in comparison with ANN and ANFIS techniques in the presence of power curves data of wind farms.

However, there is no comprehensive study about DL techniques in solar and wind energies. Also, the present study categorizes DL techniques into two categories, namely, single and hybrid methods, and focuses on advantages and disadvantages of each method.

Table 1 divides possible DL techniques applied in the field of renewable energies. It classifies DL methods in terms of model and energy resource type and provides comprehensive information on the use of these methods in solar and wind energies.

The main contributions of the present survey can be summarized into five bullets:

- To investigate the energy policy applied with AI techniques in solar and wind sectors
- To categorize DL methods in single and hybrid methods

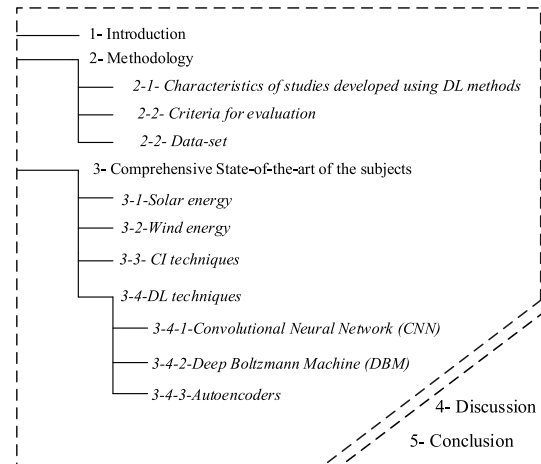

FIGURE 1. The structure of the completion process of the study.

- To analyze architectures of single and hybrid DL methods
- To compare single DL and hybrid DL with computational intelligence methods
- To highlight those robust methods applying DL

Fig. 1 shows the organization of this study. Section 2 provides the background on key concepts including characteristics of DL techniques and criteria for evaluations as well as data-sets. Then, it classifies studies based on key metrics and identifies ideas of the previous studies. Section 3 describes the-state-of-the-art of CI and DL techniques applied in solar and wind energy, which were frequently employed in optimizing, estimating or similar applications with the aim of comparing their weaknesses and strengths. The evaluation of each method will be discussed in results and discussions. Fig. 1 presents the main structure and procedure of the present work.

II. METHODOLOGY

In this review work, 14 articles focusing on DL techniques applied to estimate or predict wind and solar energies are considered. The main platform is on studies performed in the period from 2015 to 2018. Fig. 2 indicates the yearly distribution of CI and DL articles. A large number of trend line indicates that more papers, on CI and DL applied in wind and solar energies with estimation and prediction purposes, were published from 2015 to 2018.

As is clear from Fig. 2, the number of developed DL techniques in the field of wind energy is higher than that of solar energy. The highest number of developed DL techniques is related to single methods in 2016. However, there is a lack of hybrid DL techniques for both wind and solar databases, which are prone to develop many studies in this field.

A. CHARACTERISTICS OF STUDIES DEVELOPED USING DL TECHNIQUES

Table 1 presents the characteristics of the developed studies in terms of methodology, type of energy resources, modeling methods and datasets.

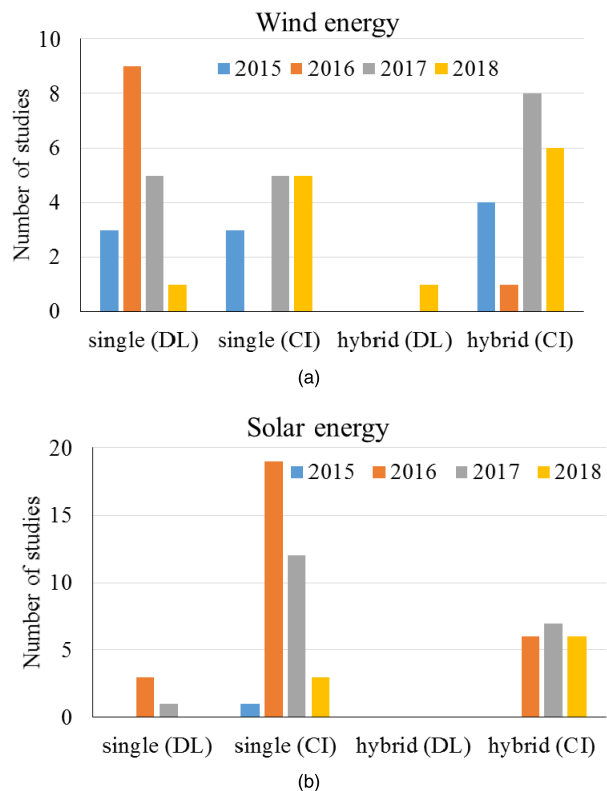

FIGURE 2. The trend of the developed studies divided by month, type of method and data-base.

Table 1 describes developed studies in details. It outlines DL techniques in terms of the type of energy resource (wind or solar energies), the developed method, datasets with their related links (if available) and the target of the study. The last column shows the pertinent references. For example, in study No. 2, [40] is categorized in studies developed with DL techniques. Its modeling methods are SAE and DBN, which are compared with MLP method as the reference model. The dataset of the study is related to SONDA project for Belo Jardim (BJD), São João do Cariri (SCR) and Triunfo (TRI), which is gleaned from <http://sonda.cptec.inpe.br/>, May 2005. The desired target is the hourly average speed of winds in the Northeastern region of Brazil. It aims to compare the performance of SAE, DBN and MLP for the prediction of the target value

B. CRITERIA FOR EVALUATION

The effectiveness of DL techniques in the present study is evaluated based on the capability of the developed methods in making the most accurate techniques for prediction, detection, optimization and monitoring purposes in the presence of the statistical metrics.

Table 2 presents the most common evaluation metrics for comparing the efficiency of the DL techniques. The second column presents a brief description of parameters.

TABLE 1. Descriptions about performed studies.

S.No	Type of energy resource	Modeling method	Data-set (s)	Target (s)	reference
1	Solar energy	DRWNN (a combination of RNN and WNN) BP	Cloud cover, the weather condition which affects irradiation. Data link is not available.	daily and hourly solar irradiation	[39]
2	Wind energy	DBN and SAE: Comparing with MLP network	Data-sets of SONDA project for Belo Jardim (BJD), São João do Cariri (SCR) and Triunfo (TRI), http://sonda.cptec.inpe.br/ , May 2005.	The hourly average speed of winds in the Northeastern region of Brazil	[40]
3	Wind energy	SAE: comparing with the PR, TDNN, NARNN, FFNN	dataset of the Western Wind data created by 3TIER and National Renewable Energy Laboratory (NREL) which contains the annual wind speed in 10-min intervals. https://www.nrel.gov/grid/western-wind-data.html	Wind speed	[41]
4	Wind energy	LR, k-NN, REP, MSP, MLP, RBF, SVM, and DNN	wind power generation information (wind speed, wind direction and past wind power) of seven wind farms in Ontario, Canada and the meteorological data corresponding to the Seven wind farms including Eribeau – Eribeau, Dillon – Chatham Kent, Spence – Ridgetown RCS, Kingsbridge – Goderich, Wolfe Island – Kingston A, Port Alma – Chatham Kent, and Part Alma 2 – Eribeau. The historical data are available at: http://ets.aeso.ca/ .	Wind power	[42]
5	Wind power	MRBM	Using 1200 hours of data (in four time durations 0-300, 300-600, 600-900, and 900-1200 h) from a wind farm located in Heilongjiang Province of China. Data are available at: www.hpi.com.cn	Wind Power	[43]
6	Wind power	WT, DBN and spine QR	Data from the Shangchuan Island wind farm in Guangdong Province, China from January 2013 to December 2013 and the Cathedral Rocks wind farm in Australia with 5-min intervals for the whole year of 2011. Data set has been presented in [44]	Wind speed	[45]
7	Wind power	Stacked de-noising auto-encoders	Data from wind farms located in Ningxia, Jilin Inner Mongolia and Gansu, China with 10 min intervals. Data link is not available.	Wind speed	[46]
8	Solar energy	MLP, LSTM, DBN and Auto LSTM	Dataset from German-Solar-Farm containing 21 photovoltaic facilities with three-hour resolution for 990 days. Data set [47] is available at: http://ies-research.de/Software	The produced solar power	[48]
9	Solar energy	DRNN	Dataset including global horizontal irradiance for March 24, February 8, October 8, and August 12. Data are available at: http://www.nrcan.gc.ca/energy/renewable-electricity/solar-photovoltaic/18409	solar irradiance	[49]
10	Wind power	CNN	The wind power data from milky way wind farm with 5-min intervals from Jan. 2011 to Dec. 2011 in the Changchun island wind farm in Shandong province and Guangdong Province, China. Link is not available.	Wind Power	[50]

TABLE 1. (Continued.) Descriptions about performed studies.

1 1	Wind power	DAE as the base, and DBN acts as the Meta-regressor	Dataset for three years from five different wind farms situated in Europe containing the power measurement and the meteorological data. Datasets is available at:[51]	Wind Power	[51]
1 2	Wind power	CNN	Dataset including solar irradiance over 18000 hours from 4 major cardinal directions through different speeds ranging from 7 to 20 m/s cloud movement. The link of dataset is not available.	Wind speed	[52]
1 3	Wind power and solar energy	DNN (LeNet-5 network)	The numerical weather prediction (NWP) variables provided in the Kaggle competition for solar radiation and NWP by the European Centre for Medium-Range Weather Forecasts for wind power. Datasets are available at: [53]	Daily aggregated solar radiation and wind energy predictions	[53]
1 4	Wind power	RNN and the hybrid EWT - LSTM-Elman model	Dataset from a wind farm in China including four sets of original wind speed series. The 1st-600 th samples as the training dataset and 601st-700 th samples as the testing dataset. Datasets are available at: [54]	Wind speed	[54]

TABLE 2. Model evaluation criteria.

Accuracy and Performance Index	Description
$MSE = \frac{1}{N \times p} \sum_{i=1}^p \sum_{j=1}^N (T_{ij} - L_{ij})^2$	-P as the number of patterns -N as the number of outputs -T _{ij} and L _{ij} are respectively the desired output value and the value calculated
$RMSE = \sqrt{\frac{1}{N \times p} \sum_{i=1}^p \sum_{j=1}^N (T_{ij} - L_{ij})^2}$	
$MAE = \frac{1}{N \times p} \sum_{i=1}^p \sum_{j=1}^N T_{ij} - L_{ij} $	
$MAPE = 100 \times \frac{1}{N \times p} \sum_{i=1}^p \sum_{j=1}^N \frac{ T_{ij} - L_{ij} }{T_{ij}}$	
$IS = 100 \times \frac{RMSE_{pres.} - RMSE}{RMSE_{pres.}}$	
$RC = \frac{\sum_{i=1}^n [(p_{M_i} - \bar{p}_M)(p_{P_i} - \bar{p}_P)]}{\sum_{i=1}^n [(p_{M_i} - \bar{p}_M)^2 \sum_{i=1}^n (p_{P_i} - \bar{p}_P)^2]}$	
$MBE = \frac{\sum_{i=1}^n [(p_{M_i} - \bar{p}_M)(p_{P_i} - \bar{p}_P)]}{\sum_{i=1}^n \frac{1}{n} \sum_{i=1}^n (T_{ij} - L_{ij})}$	

MSE = Mean square error is commonly used to measure the average square deviations to indicate the difference between the model output and the target value.

RMSE = Root mean square error, which is commonly used to indicate the difference between the actual and target values.

RC = Relative correlation or the Pearson correlation expresses the linear correlation between actual and target values.

MAE = Mean absolute error, which measures the average vertical distance between each point (target and output values).

MAPE = Mean absolute percentage error, which defines the relative average vertical distance between each point in percentage.

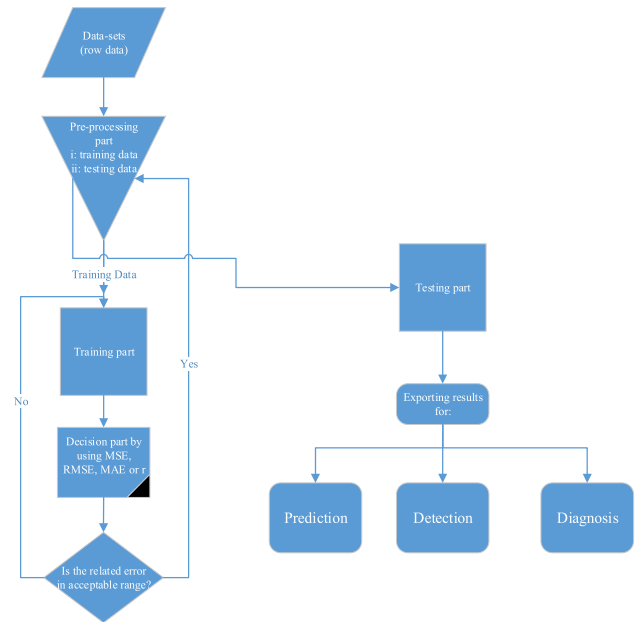

FIGURE 3. The process of application the CI methods.

IS = Improvement score, which indicates the modeling performance in case of relative error compared to the reference model in percentage.

MBE = Main bias error, which evaluates the validation of prediction and indicates the prediction error.

III. COMPREHENSIVE STATE-OF-THE-ART OF THE SUBJECTS

DL is a subset of CI techniques. To our best of knowledge, CI approach can do complex tasks such as learning, modeling or getting a pattern from an experimental approach (such as data or observations) with the help of a computer. Sometimes it is referred to as soft-computing method. ANN, Fuzzy, genetic based algorithms and similar methods derived from these methods are subsets of CI approaches [22]. CI methods are employed in all fields of science to facilitate organizing and studying processes of data-sets, especially big data-sets [55]. In fact, these methods are used as single or hybrid method. Each of them has its own advantages and disadvantages. Fig. 3 indicates the logic and general application process of CI methods. This process has four main components, namely, processing part, training part, decision part and resulting part.

In the present study, the main aim is to investigate architectures of DL applied in renewable energy field and evaluate the performance of DL in wind and solar energy sector. This paper also aims to study other CI methodologies, which were applied in wind and solar energies.

Finally, both single and hybrid methods of CI and DL are studied and are compared in term of their performance under the same data-set. In case of single methods, a CI method (i.e. ANN, FIS, GA, PSO or other CI approach) is employed solely for predicting, modeling or exploring data of clean energy

resources [56]. These methods are fast and simple, which can be one of their main advantages. The only disadvantage of these methods can be their low accuracy in big data-sets.

On the other hand, hybrid methods refer to combinations of more than one CI method or the optimization of a CI method by using other learning algorithms. This can help to eliminate the shortcomings of using single methods in big data-sets and to improve the system performances. Therefore, the main advantages of hybrid methods are their high scalability, reliability and adaptively in big renewable data-sets.

CI techniques contains three main sections, namely, pre-processing, training and testing units. First, a data-set is imported to the process. Then, the data is placed under pre-processing for dividing into two main categories, training and testing datasets, which are products of pre-processing part. In the pre-processing part, the raw data is transformed into understandable format to continue the process. Accordingly, the training data is used for developing the network (or model). In the second part, the training data is imported to the training part. The CI algorithms uses training data to learn the model or network.

The outputs of training part are imported to the decision part that decides the accuracy of the composed model by using comparing factors such as MSE, RMSE, MAE, MAPE or R in training phase. The next step is to use the testing data to determine the prediction performance.

These factors compare outputs of the composed model with target values (actual values) to find out how close they are. If the computed error values are in permissible range, the process comes back to the pre-processing part and takes the testing data and imports the testing data to the selected data and takes the results to be used in prediction, detection or diagnosis purposes. However, if the computed error is higher than the expected range, the process comes back to the training part again, in order to select other algorithm or other training approach for reducing the expected error. This process is repeated until attaining the desired range of error between target and output values.

A. SOLAR ENERGY

This energy resource is considered as the primary energy resource that is being widely applied in applications of heating, architecture and urban planning, agriculture and horticulture, transport and fuel production. References [57]–[59]. This energy resource is one of the clean resources for energy production, which is one of fields with big dataset. It is a popular field for researchers to apply CI techniques for different purposes. Big data, which are employed in this field, make different challenges for estimation, optimization and decision making as well as policymaking systems and require serious considerations to attain a sustainable energy system. Therefore, there needs to be a method with high accuracy. There are different methods in CI techniques that can be employed for these purposes. There is a need for trial and error to take a method with a high accuracy. Big dataset

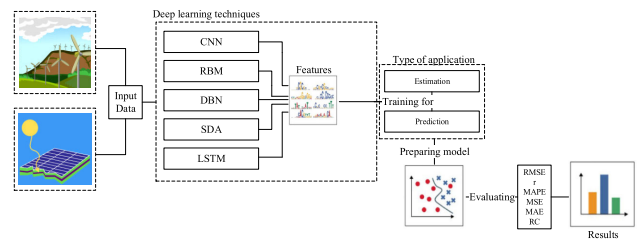

FIGURE 4. Application of DL techniques in solar and wind energies.

in solar energy systems are apt to the use of accurate and sustainable methods like DL techniques.

B. WIND ENERGY

Wind energy is considered as another renewable energy sources for supplying demands in cities and remote areas [60]. This energy source is known as a non-exhaustible, clean and benign environmental source of energy that is available in most countries [61]. It was approximated to have about 10 million MW of total accessible wind energy and there were about 432 (GW) of the installed wind energy sites by the end of 2015 [62], [63]. The main reason to develop different methods in the field of wind energy is similar to that for the solar energy. Furthermore, the production of laboratory equipment and their use in wind energy are costly. Therefore, modeling methods for the prediction, estimation or optimization purposes can be an effective step in attaining higher goals, with the provision that the method has high accuracy. The development of DL techniques can be a major step in accomplishing these purposes.

Fig. 4 presents a brief schematic diagram of DL techniques applied in solar and wind energies.

C. DL TECHNIQUES

Deep learning technique is considered as a class of machine learning techniques. The most typical and applied DL techniques include RNN, WNN, RWNN, DBN, MRBM, CNN, LSTM, DNN, RMT and SAE, which are briefly presented in this section. Applications of this techniques are in language, audio and speech processing, machine translation, computer vision, social network filtering and board game programs, and applications which use or produce a huge amount of data or depend on a big data feature [64]. Recently, DL techniques are adopted for solving traditional artificial intelligence problems. In this section, the concepts of deep learning methods, its architectures are described in general terms.

1) CONVOLUTIONAL NEURAL NETWORK

In CNNs, several layers are trained in a way for reaching a high performance. This commonly used method is very efficient method in various applications, especially computer vision [65]. Fig. 5 presents an outline of the architecture of a CNN.

Each CNN benefits by a two-stage training process, the feed-forward, and the back-propagation stages. In the first

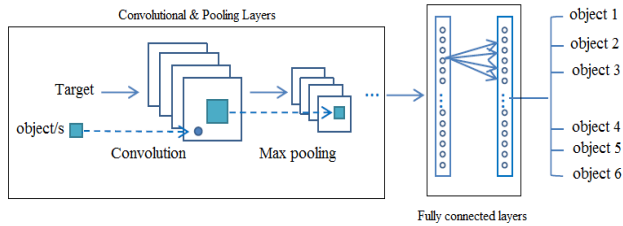

FIGURE 5. The general architecture of a CNN adapted by [66].

step, the input target is fed to the network. This is a multiplication of points between the input target and the parameters of each neuron, ultimately imposing convolutional operations on each layer. The network output is computed, which is then used to compute the network performance. To do this, the outputs of the network have to be compared by using a loss function with the correct response in order to compute the error. In the next stage, the back-propagation phase begins based on the computed error. In this step, the gradient of each parameter is computed according to the chain rule, and all parameters are changed according to effects on the error generated in the network [67]. After the parameters are updated, the next step is the feed-forward. After completing the correct number of these steps, the network training ends.

Lee et al. [52] developed CNN technique to estimate 4 field-based wind fields using dataset collected from 4 major cardinal directions from cloud movement. Based on results, this was an accurate and cost-effective method for developing grid sensor-networks for wind field estimation. In another study, Sun et al. [68] developed an approach for the estimation of photovoltaic output energy by using CNN method in the presence of sky images as the input value. Based on this assumption, the images taken from the sky could determine the cloud coverage of the position of the sun. Datasets were categorized in three situations, namely, sunny, partly cloudy and overcast. Photovoltaic panels were placed on the top of two buildings (henceforth Y2E2 and Huang buildings in California) RMSE was employed to evaluate the datasets. RMSE values for Y2E2 were 0.064, 0.338 and 0.051 kW for sunny, partly cloudy and overcast conditions, respectively and for Huang were respectively 0.528, 2.483 and 2.753. Wang et al. [50] developed a hybrid WPF-CNN approach to predict the probabilistic wind power. The required data were collected from a wind farm in China. The benchmark methods were BP-QR and SVM-QR techniques. The evaluation of the developed models were performed in four seasons. The evaluation factor was CPRS value. Increasing the power output increased the CPRS in all techniques, except the proposed technique. In general, the proposed technique had the lowest CPRS compared with those for other techniques. This showed a high potential of the proposed technique in predicting the wind power. This also reduced the error and increased the accuracy of the method.

Table 3 presents details about the studies developed by CNN method. Table 4 arranges the studies by the type of CNN

TABLE 3. Details about studies developed by CNN method.

Reference	Type of the method	Types of the application	Description of the model	Pros and cons
[52]	Single CNN	Wind speed	Two convolutional layers with two Fully-connected layers and one pooling with Rectified Linear Unit activation layers. The structure of filters is four by four by one by fourteen.	<i>Advantages:</i> This method is successfully applied in the most fields and have the best correlation in the way of the aim of study and have an acceptable accuracy especially in image data.
[68]	Single CNN	Solar energy	Two convolution layer with 12 filters and 24 filters as other filters which have been combined with two fully connected layers	<i>Disadvantages:</i> This method needs a high computational cost. On the other hand, it needs a large dataset to be an efficient method. This method also needs a high graphical processing unit because of the nature of the required data. Using a hybrid CNN technique cannot improve its disadvantages.
[50]	Hybrid WPF-CNN	Wind power	Input layer which converts 1D data to 2D image, future extractor layers which contain convolution layer and sub-sampling layers and predictor which converts 2D image to 1D data and uses logistic regression to generate the output values.	

TABLE 4. Accuracy factors related to the studies applying CNN technique.

Reference	Methods/Datasets	Evaluation criteria	
		RMSE	CRPS
[52]	CNN	✓	-
[68]	CNN/Sunny for Y2E2	✓	-
	CNN/Partly cloudy for Y2E2	✓	-
	CNN/Overcast for Y2E2	✓	-
	CNN/Sunny for Huang	✓	-
	CNN/Partly cloudy for Huang	✓	-
[50]	CNN/Overcast for Huang	✓	-
	Persistence	-	✓
	BP+QR	-	✓
	SVM+QR	-	✓
	WT+CNN	-	✓

method (single or hybrid method), the type of application (wind or solar), structure of method and pros and cons.

Based on Table 4, most of the comparisons are performed by RMSE values. Yet, in the case of comparing single and hybrid methods, there are no specific factors in these three studies, which render it difficult to compare hybrid and single

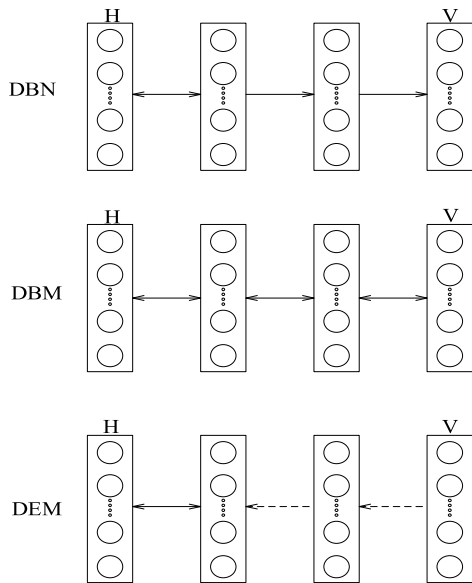

FIGURE 6. Comparison of structures of DBN, DBM and DEM adapted by [71].

methods. On the other hand, the dataset values are not the same, and this is the second problem in comparing these methods. In overall, CNN can best perform tasks in large datasets. Reference [50] can be the evidence of this claim. The hybrid WT-CNN method (with CPRS 3.324) has the best performance among other hybrid techniques. Besides, based on Table 4 it can be claimed that CNN is extremely sensitive to the dataset.

2) RESTRICTED BOLTZMANN MACHINE

RBM is a kind of Boltzman Machine that has a limitation by making a bipartite graph by visible and hidden units. This limitation creates more optimal training algorithms such as the gradient-based algorithm [69]. In this model the hidden units (H) and the visible units (V1) are conditionally independent because that is a bipartite graph. In Eq. 1, both H and V1 satisfy Boltzmann's distribution.

$$P(HV_1) = P(H_1V_1)P(H_2V_1) \dots P(H_nV_1) \quad (1)$$

V1 can be obtained through $P(HV_1)$. Accordingly, V2 can be obtained through $P(H_2V_1)$. The difference between V1 and V2 can be minimized by setting the parameters and the resulting H, as the best feature of V1. Using RBMs as learning modules can help to develop DBNs, DBMs and DEMs. Fig. 6 compares these three models. As is clear, DBNs provide undirected connections in the upper two layers that form an RBM and have directed links (directed) in the lower layers. DBMs have unmatched connections between all network layers. DEMs also have deterministic hidden units for lower layers and stochastic hidden units for the top layer [70].

DBN is a potential generator model that provides common probability distribution over visible data. DBN first uses an effective layer-by-layer learning technique for deep

network initialization (parameters) and then carefully adjusts all weights together with expected outputs (fine-tuning). The method of greedy learning has two benefits [72]: 1) provides a proper initialization for the network, since it is difficult to select the parameter, which may cause poor local optima selection, 2) unsupervised learning model that does not require a class label, since it eliminates the need for tagged data for training. By creating a DBN model, its computing process is costly because it requires multiple RBM training, and it is not clear how to maximize the probability of learning to optimize the model [70]. DBNs have successfully led researchers into DL, and as a result, many species were produced [73], [74].

Like RBM, DBM is also one of the subsets of the Boltzmann family. In fact, DBMs contain multiple layers with hidden units in the layers with the individual number of the even-numbered layers, and vice versa. In spite of visible units, computing the posterior distribution on hidden units can no longer be tracked, which is the result of interactions between hidden entities. At the time of network training, DBM teaches all the layers of a specific unsupervised model and uses a SML algorithm to maximize the borderline in probability [75]. In other words, this means applying only one or more updates by using the MCMC method. In order to prevent the local weak minima that leave many hidden units inactive, a greedy layer-based education strategy was also applied to layers in the pre-training DBM network, which was much like what was done in DBN [70].

The joint training brings promising enhancements both to the likelihood and to the proficiency of the feature-rich learners. But the critical shortcoming of DBMs is the complexity of the approximation inference, which is much higher than DBNs. This also improves DBM parameters for massive datasets. Some researchers have introduced an approximate derived algorithm [76], [77] to increase the efficiency of DBMs. This algorithm initializes the latent variables' values by employing a recognition model in all layers. The required improvements can occur in the pre-training phase [77], [78] or at the beginning of the training phase [79], [80].

In this section, the LSTM technique is introduced. It is because most developed studies are a combination or are compared with LSTM methods. The basis of LSTM technique is RNN, which uses temporal information of the input data. LSTM benefits memory cell as a special neuron structure, which can store the information over the desired time. The input and output values of a neuron's memory cell have been controlled by the input, output, and forget gates. Each gate gets the input neuron and processes an activation function [48].

Peng *et al.* [43] presented a hybrid MRBM-WPP technique to predict a very short term wind power and compared it with BPNN-WPP technique. Dataset was categorized in four durations for 1200 hr. and was collected from a wind farm in Heilongjiang Province of China. Based on results, RMSE of MRBM-WPP was a little lower than that for BPNN-WPP in all durations except duration 300-600hr, in which the

performance of BPNN-WPP was higher than that for the MRBN-WPP. MRBM-WPP technique is a time-consuming technique and its performance strongly depends on number of the RBM layers and nodes. In this case, it is recommended to switch to known and simplified methods with high or same performance.

In a study by Zhang *et al.* [81], a deep Boltzman Machine method was employed to estimate both short- and long-term wind speed. Data were related to the local data in the southern China coast recorded on December 15, 2012. The performance of the proposed method was compared with the performance of linear autoregressive, SVR and ANFIS methods by using MSE and MAPE. In all cases, the proposed method had the lowest value for MAPE and MSE, which showed its highest performance. Sergio and Ludermir [40] employed solar and wind databases for Belo Jardim, São João do Cariri and Triunfo in Brazil to develop a DBN network and to compare it with MLP technique. Based on results, MLP had the lowest MSE for predicting the wind speed in Belo Jardim and São João do Cariri, but in case of Triunfo, the MSE of DBN was lower than that for MLP. In this study there was no specific evidence about the DBN superiority to the MLP. It could be due to the number of data employed in this study. Sometimes in case of using low number databases, DL techniques cannot indicate their high capability compared with other CI techniques.

Wang *et al.* [45] proposed a novel hybrid WT-DBN-QR technique to estimate the wind speed. Validation of the proposed method was performed by comparing with the outputs of ARMA, BPNN and MWNN. Dataset contained wind speed data series in China and Australia in four seasons (spring, summer, fall, winter). The performance factors were MAE, RMSE, and MAPE. Based on results, the proposed method had the highest performance in predicting the dependent variable in both places. The proposed method was a hybrid method. That study also showed the high ability of a hybrid method in estimation compared with a single method. Gensler *et al.* [48] employed MLP, LSTM, DBN and Auto-LSTM techniques to estimate solar power using dataset collected from German Solar Farm with 21 photovoltaic facilities. Data resolution was three-hour for 990 days. The performance factors for comparing the methods were RMSE, correlation coefficient and MAE. Based on results, Auto-LSTM technique with a highest correlation coefficient and lowest RMSE and MAE was the best technique with a highest performance, which was followed by DBN.

Liu *et al.* [54] developed hybrid EWT-LSTM-Elman, EMD-LSTM-Elman, WPD-LSTM-Elman, EWT-Elman and EWT-BP to estimate the wind speed. Dataset contained a four-set original wind speed data collected from a wind farm in China in three series. The performance of the mentioned methods was also compared with single methods including ARIMA, BP, GRNN, LSTM and Elman by using MAPE, MAE and RMSE. Based on results, hybrid methods had a significantly high performance compared with those for single methods. EWT-LSTM-Elman had the highest performance

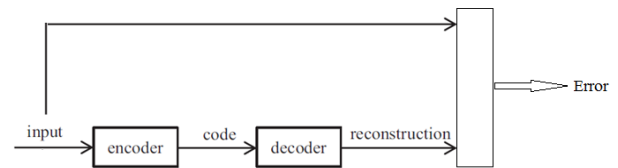

FIGURE 7. The general process of an AE adopted by [82].

for predicting wind speed. Among single methods, ARIMA had the highest performance, which was followed by LSTM. The lowest performance was related to BP technique with a significant difference.

Cao and Lin [39] employed a ten-year data set for training and testing models for the prediction of daily and hourly global solar irradiations by using BP and DRWNN models. The models had two inputs (time and daily irradiance) and two outputs (daily and hourly global solar). DRWNN could predict the daily global solar irradiation with 6.78% of MRE, 0.0216 MJ m⁻²h⁻¹ of RMSE, which were lower than those for BP. This showed a higher performance of DRWNN in estimating an output under the presence of a large dataset compared with those for BP. Therefore, DRWNN had the best accuracy compared with BP in line with the aim of the study. Alzahrani *et al.* [49] developed LSTM technique to forecast solar irradiance based on the real data recorded by Natural Resources from Canada. The results were compared with SVR and FNN by using RMSE and MBE factors. Deep learning (LSTM) technique had the highest performance compared with other techniques.

Table 5 presents details about the studies developed by DBM, DBN, RBM and LSTM methods. Table 6 arranges the studies by type of DBM, DBN, RBM and LSTM methods (single or hybrid method), type of application (wind or solar), structure of method and pros and cons.

Table 6 indicates the evaluation metrics applied for DBM, DBN, RBM and LSTM methods. It concludes that the most useful performance metrics for comparing the results are RMSE, MAE and MAPE. The numerical results differ from an evaluation metric to another. One of the main reasons for this finding is that the dataset characteristics such as size, dimension and etc. Thus, the proposed methods have a high dependence on the characteristics of dataset to obtain the best accuracy. For example, Authors [81], developed DBN which indicates the best performance compared with SVR and ANFIS but the difference was not meaningful.

3) AUTOENCODER

AE is a special type of ANN to optimize the encoding of learning [82]. Instead of teaching the network and predicting the target value of Y in return for input X, one will learn an AE to reconstruct one's input X. Accordingly, the output vectors will have the same input vector dimensions. Fig. 7 presents the process of an AE, in which AE is optimized with minimization of the reconstruction error.

In general, a single layer is not capable of receiving distinctive features of raw data. Researchers are currently using

TABLE 5. Details about studies developed by DBM, DBN, RBM and LSTM methods.

Ref	Type of the Method	Types of the application	Description of model	Pros and cons
[43]	Hybrid MRBM-M-WPP	Wind power	The structure of MRBM contained four RBM units. This architecture has a feature extractor. This unit identifies and transforms the features layer by layer. The last layer (the predictor layer) uses a BPNN and feature extractor unit in training by using its output value. This trend is employed to generate the wind power values.	Advantages: Its high capability for computational proposes. Disadvantages: A single bottom-up pass limits its approximation's approach. Its processing unit is slow.
[81]	Single DBM	Wind speed	This study uses two algorithms for training RBM and pre-training data. The trained RBM and data are imported by the pre-training unit and after a good initialization for all the model parameters, the output and the data are imported by fine tuning unit, which uses BP algorithm then generates the output of the Boltzman network	
[40]	Single DBN	Wind speed	75% of data were employed to train and 25% to test the networks. Pre-training were performed by the use of two approaches. In the first case, auto-encoder method was used and noise was added to the input data which is known as SADE. In the second case, Restricted Boltzmann Machine was used as layers which is known as DBN.	Advantages: This method is suitable for image data. Because it has a high capability in processing the similar images. Disadvantages: This method increases the running time and the complexity of the system.
[45]	Hybrid WT-DBN-QR	Wind speed	The proposed method combines WT, DBN and QR. Wind speed data be imported by the method then WT, decomposes data are into four frequencies. Then, based on the number of frequencies (four frequencies), 4-layer DBN has been adopted to estimate the signal. 50 and 20 hidden neural have been selected in two hidden layers. For each detailed signal, a 10-layer DBN is properly designed. The number of hidden neurals in each layer were 65, 30, 45, 15, 60, 10, 20 and 15.	
[48]	Single DBN	Solar power	There are no specific information about DBN structure.	
[49]	Single LSTM	Solar irradiance	DRNN with LSTM with 35 hidden neurons into two hidden layers	
[54]	Hybrid LSTM	Wind speed	EWT was employed to split the wind speed data into sub-layers. Then in order to estimate the low and high frequencies' sub-layers, they were employed LSTM and Elman neural network, respectively	Advantages: LSTM benefits all advantages of RNN. Such that this method is for time series data and make shorter the pre-processing of data
[48]	Hybrid Auto LSTM	Solar power	Feature learning was performed using AE then LSTM was employed to the encoding part of the AE. The developed Auto-LSTM in order to predict the new output, employed two previous time steps.	Disadvantages: Training process is difficult. It cannot accumulate to very deep models
[39]	Hybrid RNN, WNN	Solar irradiance	The nodes of RNN hidden layers adopt by WNN. This make more capable method for predicting the solar irradiance. The nature of this dataset is to change frequently and is extremely non-linear. This architecture can do this task successfully.	

a deep AE to send the code learned from the previous AE to the next AE to complete their work. AE is often trained with

TABLE 6. Accuracy factors related to studies applying DBM, DBN and RBM methods.

Reference	Methods/D atassets	Evaluation criteria						
		r	RMSE	MAE	SDE	MAPE	MRE	MBE
[43]	Hybrid MRBM-WPP	-	✓	✓	-	-	-	-
[81]	AR	-	✓	-	-	✓	-	-
	ANFIS	-	✓	-	-	✓	-	-
	SVR	-	✓	-	-	✓	-	-
[40]	DBM	-	✓	-	-	✓	-	-
	MLP	-	-	✓	-	✓	-	-
[45]	DBN	-	-	✓	-	✓	-	-
	Hybrid MRBM-WPP	-	✓	✓	-	-	-	-
	ARMA	-	✓	✓	-	✓	-	-
	BPNN	-	✓	✓	-	✓	-	-
[48]	MWNN	-	✓	✓	-	✓	-	-
	Hybrid WT+DBN	-	✓	✓	-	✓	-	-
	P-PVFM	✓	✓	✓	-	-	-	-
	MLP	✓	✓	✓	-	-	-	-
[49]	LSTM	✓	✓	✓	-	-	-	-
	DBN	✓	✓	✓	-	-	-	-
	Auto-LSTM	✓	✓	✓	-	-	-	-
	FNN	-	✓	-	-	-	-	✓
[39]	SVR	-	✓	-	-	-	-	✓
	LSTM	-	✓	-	-	-	-	✓
[54]	BP	✓	✓	-	-	-	✓	-
	DRWNN	✓	✓	-	-	-	✓	-
	ARIMA	-	✓	✓	-	✓	-	-
	BP	-	✓	✓	-	✓	-	-
	GRNN	-	✓	✓	-	✓	-	-
	LSTM	-	✓	✓	-	✓	-	-
	Elman	-	✓	✓	-	✓	-	-
	EWT-BP	-	✓	✓	-	✓	-	-
	EWT-Elman	-	✓	✓	-	✓	-	-
	WPD-LSTM-Elman	-	✓	✓	-	✓	-	-
EMD-LSTM-Elman	-	✓	✓	-	✓	-	-	
EWT-LSTM-Elman	-	✓	✓	-	✓	-	-	
WDD-WPD-ARMA(SS)-EMD-ELM(NS)-OCM	-	✓	✓	-	✓	-	-	

a kind of back-propagation operation. Although most of this model is efficient, it can be extremely inefficient in the event of an error in the first layers. A good way to eliminate this problem is to pre-train the network with initial weights that approximate the final solution [83].

Khodayar and Teshnehlab [41] employed a novel hybrid SAE+Rough Regression technique to predict the wind speed. This structure helped to attain a robust DNN to generate the related output values. The performance factor was RMSE. In order to indicate the capability of the proposed method, its performance was compared with those for PR, TDNN, NARNN, FFNN and SAE in five-time steps, namely, 10-min, 30-min, 1-hr, 2-hr and 3-hr. Based on results, increasing the

time-step increased the RMSE value due to the increase of the number of dataset. In all time steps with no exceptions, the proposed method had the lowest RMSE value compared with those for the mentioned techniques. Therefore, efforts to develop a new hybrid method were effective. This study also produced additional results. In case of comparing single methods, SAE had the lowest RMSE among other single techniques (PR, TDNN, NARNN and FFNN). Yet, the proposed method was a hybrid method. The results indicated that hybrid methods have the ability to predict data with a high degree of accuracy than single-mode methods. Hu *et al.* [46] developed a hybrid SDAE technique to predict wind speed. Dataset included historical wind speed data in four-time range (10-min, 30-min, 1-hr. and 2-hr.) with seven target domains (0.5, 1, 2, 3, 4, 5 and 6 months) from four wind farms located in Ningxia, Jilin, Inner Mongolia and Gansu, China. The results of the proposed method were compared with single DNN, SVR and ELM by using MAPE and MAE. In all cases, the proposed hybrid technique had the lowest MAPE and MAE, which showed its high performance compared with single techniques. Qureshi *et al.* [51] employed Transfer Learning and Meta Regression based AE to predict wind power. The performance parameters were MAE, RMSE and SDE. Dataset contained meteorological and power measurement data for five wind farms, which were collected during three years in Europe. The performance of the proposed method was compared with those for GPeANN, SVR (linear kernel) and SVR (RBF kernel), individually for each farm. Based on result, on average, the proposed method (DNN-MRT) had the lowest RMSE, MAE and SDE, followed by GPeANN. Both DNN-MRT and GPeANN were hybrid techniques while SVR is a single method. Based on results, the accuracy of hybrid techniques was significantly higher than those for single methods. Therefore, their results indicated two important points, namely, the importance of hybrid techniques and a high accuracy of deep learning techniques in large datasets compared with other CI techniques.

Table 7 presents details about studies developed by SAE method. Table 8 arranges the studies by the type of the developed methods (single or hybrid method), the type of application (wind or solar), structure of method, and pros and cons.

Based on Table 8, RMSE and MAE are the most popular performance factors for comparing results of SAE-based studies. As is clear from numerical results presented in Table 8, in some cases the proposed SAE method has the best result compared with others. In some cases, the difference is not too high, but in some cases, the difference is meaningful. In the study developed by [41], the difference between FFNN and SAE is not meaningful. In those cases, it is recommended to employ FFNN and, based on Table 7, SAE needs additional training time, which renders the process slow. In [51], the differences among the proposed method and others are meaningful. This means that the proposed model with a high difference can be the best method for that target.

TABLE 7. Details about studies developed by SAE method.

Ref	Type of the Method	Types of the application	Description of model	Pros and cons
[41]	SAE	wind speed	AEs in the first hidden layers and a regression layer with a linear function at the top of the AEs. AEs for unsupervised feature learning and regression layer for supervised learning. SAE contained three AEs.	Advantages : AEs use filters to fit the dataset better and improve the performance.
[46]	SDAE	Wind speed	This method uses a knowledge transfer. This means that each data-set benefits an individual universal feature. The hidden and the input layers shared all datasets and can be considered as a common feature transformation. Each farm has its own output layer since its data distribution differs from that of other farms.	Disadvantages: Additional training time.
[51]	DAE	Wind power	This model employed 9 AEs with different neuron number and epoch. Please use ref. [51] for more details about the architecture of the developed model	

TABLE 8. Accuracy factors related to studies applying SAE method.

Reference	Methods/Datasets	Evaluation criteria			
		RMSE	MAE	SDE	MAPE
[41]	PR	✓	-	-	-
	TDNN	✓	-	-	-
	NARNN	✓	-	-	-
	FFNN	✓	-	-	-
	SAE	✓	-	-	-
[46]	DNN	✓	✓	-	✓
	SVR	✓	✓	-	✓
	ELM	✓	✓	-	✓
	SDAE	✓	✓	-	✓
[51]	ARIMA	✓	✓	✓	-
	SVR (linear kernel)	✓	✓	✓	-
	SVR (rbf kernel)	✓	✓	✓	-
	GPeANN	✓	✓	✓	-
	DAE	✓	✓	✓	-

IV. DISCUSSIONS

This section presents discussions and conclusions extracted from results of studies performed in the case of using DL techniques and other CI methods for estimation or prediction of the performance of wind and solar energies. Fig. 11 illustrates the categorized form of CI techniques employed in line with the aim of the present study. Based on Fig. 8, DL techniques are a particular subset of CI techniques; therefore, one of the procedures of this study is to compare the performance DL techniques with those for other CI techniques to express weaknesses and strengths of DL techniques.

Fig. 8 presents of the top 10 types of single and hybrid DL techniques applied for solar and wind energy.

Fig. 9 presents the percentage of using DL and other CI techniques in solar and wind energies from 2015 to 2018.

TABLE 9. Comparison of different methods.

	Method	accuracy	reliability	Sustainability
[41]	PR (Khodayar et al.)	Very low	Very low	Very low
	TDNN (Khodayar et al.)	low	low	low
	NARNN (Khodayar et al.)	medium	medium	medium
	FFNN (Khodayar et al.)	medium	low	low
	SAE (Khodayar et al.)	Very high	high	high
	[46]	DNN (Hu et al.)	low	low
SVR (Hu et al.)		medium	low	low
ELM (Hu et al.)		medium	medium	medium
SDAE (Hu et al.)		medium	medium	medium
[51]	ARIMA (Qureshi et al.)	medium	medium	medium
	SVR (linear kernel) (Qureshi et al.)	high	high	medium
	SVR (rbf kernel) (Qureshi et al.)	high	medium	medium
	GPeANN (Qureshi et al.)	Very high	high	medium
	DAE (Qureshi et al.)	Very high	high	high
[43]	Hybrid MRBM-WPP (Peng et al.)	high	high	high
[81]	AR (Zhang et al.)	low	low	low
	ANFIS (Zhang et al.)	high	high	medium
	SVR (Zhang et al.)	medium	medium	medium
	DBM (Zhang et al.)	low	low	low
[40]	MLP (Sergio et al.)	low	low	low
	DBN (Sergio et al.)	medium	medium	medium
	Hybrid MRBM-WPP (Wang et al.)	high	high	high
	ARMA (Wang et al.)	medium	medium	medium

TABLE 9. (Continued.) Comparison of different methods.

[45]	BPNN (Wang et al.)	low	low	low
	MWNN (Wang et al.)	low	low	low
	Hybrid WT+DBN (Wang et al.)	Very high	high	high
[48]	P-PVFM (Gensler et al.)	Very low	Very low	Very low
	MLP (Gensler et al.)	low	low	low
	LSTM (Gensler et al.)	high	high	high
	DBN (Gensler et al.)	high	high	medium
	Auto-LSTM (Gensler et al.)	Very high	Very high	high
[49]	FNN (Alzaharani et al.)	low	low	low
	SVR (Alzaharani et al.)	high	medium	medium
	LSTM (Alzaharani et al.)	Very high	high	high
[39]	BP (Cao et al.)	low	low	low
	DRWNN (Cao et al.)	medium	medium	medium
[54]	ARIMA (Liu et al.)	medium	medium	medium
	BP (Liu et al.)	Very low	Very low	Very low
	GRNN (Liu et al.)	low	low	low
	LSTM (Liu et al.)	high	high	high
	Elman (Liu et al.)	medium	medium	medium
	EWT-BP (Liu et al.)	high	high	high
	EWT-Elman (Liu et al.)	high	high	high
	WPD-LSTM-Elman (Liu et al.)	high	high	medium
	EMD-LSTM-Elman (Liu et al.)	high	high	high
	EWT-LSTM-Elman (Liu et al.)	Very high	high	high

TABLE 9. (Continued.) Comparison of different methods.

	WDD-WPD-ARMA(S)-EMD-ELM(NS)-OCM (Liu et al.)	high	high	medium
[52]	CNN (Lee et al.)	high	high	high
[68]	CNN/Sunny for Y2E2 (Sun et al.)	medium	medium	medium
	CNN/Partly cloudy for Y2E2 (Sun et al.)	high	high	medium
	CNN/Overcast for Y2E2 (Sun et al.)	medium	medium	medium
	CNN/Sunny for Huang (Sun et al.)	medium	medium	medium
	CNN/Partly cloudy for Huang (Sun et al.)	medium	medium	medium
	CNN/Overcast for Huang (Sun et al.)	medium	medium	medium
[50]	Persistence (Wang et al.)	medium	medium	medium
	BP+QR (Wang et al.)	medium	medium	medium
	SVM+QR (Wang et al.)	medium	medium	low
	WT+CNN (Wang et al.)	high	high	medium

From Fig. 9, EMD and GRN have the most share of application and can be considered as the most popular DL techniques to be employed in this field. It is obvious that the share of hybrid methods for DL techniques is lower than those for the single techniques. Therefore, this field is prone to the use of hybrid techniques.

Fig. 10 indicates the share of each performance factor used by authors to compare or present the performance of developed models.

Based on Fig. 10, RMSE is the most applied and popular performance factor by authors (more than 40%) and RC is the low-applied factor (lower than 1%).

Fig. 11 indicates RMSE values for studies developed by DL techniques (studies No. 1 to 14) since most studies

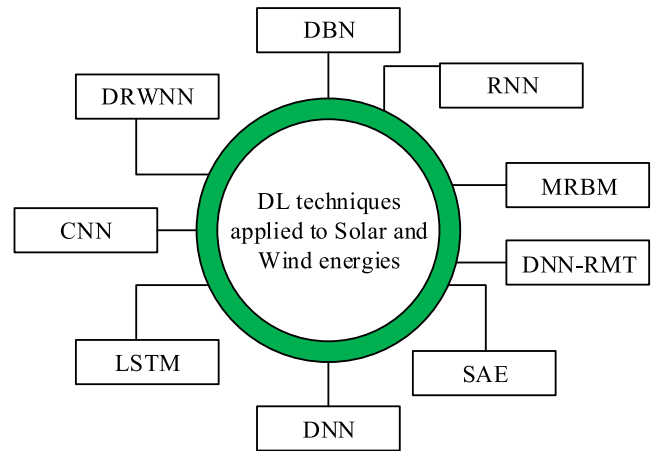

FIGURE 8. DL techniques for predicting approaches in clean energies.

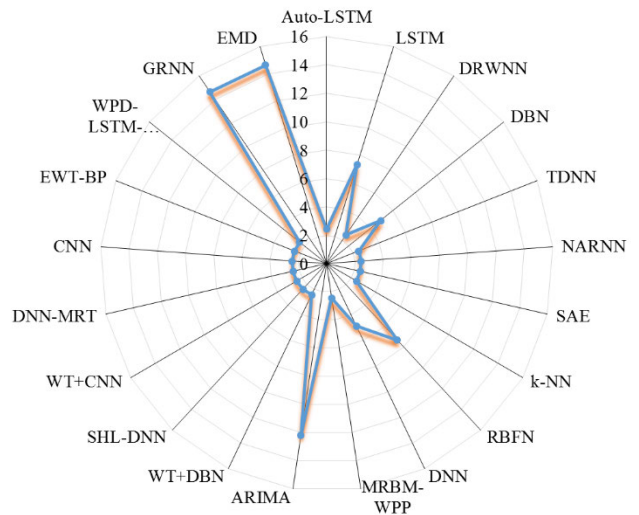

FIGURE 9. The percentage of using DL and other CI techniques in solar and wind energies from 2015 to 2018.

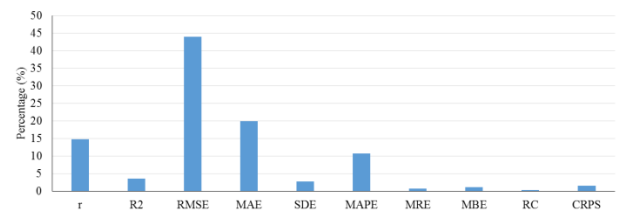

FIGURE 10. The share of performance parameters applied in the datasets of this study.

discussed in DL techniques (the above 14 studies) were compared by RMSE.

Given the fact that the datasets are different, we have to make comparisons within the group for each study individually by grouping based on the number of each study.

From Fig. 11, it can be claimed with certainty that DL techniques have the best performance with the lowest value of RMSE compared with their rival methods in each group.

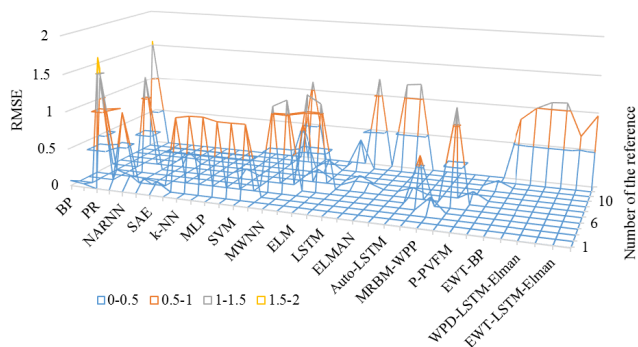

FIGURE 11. RMSE values in each study grouped by the number of studies.

On the other hand, from the results of groups that compare single and hybrid DL techniques, it turns out that hybrid techniques have higher performance compared with single techniques (DRWNN in group 1, SAE in group 3, DNN in group 4, MRBM-WPP in group 5, WT+DBN in group 6, SHL-DNN in group 7, LSTM and auto-LSTM in group 8, LSTM in group 9, DNN-MRT in group 11, CNN in group 12 and EWT-LSTM-Elman in group 14). It should be noted that other studies in DL techniques which were not mentioned in Fig. 10, did not use RMSE as a public comparison factor.

Table 9 presents comparison regarding the accuracy, reliability and sustainability of methods developed for handling building energy information by using DL techniques. Table 9 shows discussions and conclusions on the above-mentioned articles, as extracted from our studies. This table is considered as one of the most important parts of this study, which can be used by authors and policy-makers in this field.

Table 9 provides a comparison among methods developed for each study. As is clear, the scores have been divided into five categories including very low, low, medium, high, very high for indicating the performance of the methods.

In this table, criteria metrics are accuracy, reliability and sustainability. Accuracy and reliability have been exported from the training and testing results of each method and referred to the acceptability of method, but sustainability has been exported from the pros and cons of methods, which have been reported by different studies. This criteria metric directly refers to the performance of method.

Fig. 12 presents a graph for each method based on their robustness. Fig. 12 is categorized into four limitation ranges including high, good, medium and low robustness score to describe the capability and strength of each method based on our observations and understandings from conclusions and results of each study.

This figure has been extracted from table 9 based on our own observations, investigations and researches. It is clear from Fig. 12 that DL techniques are categorized in good and robust categories, which are followed by hybrid

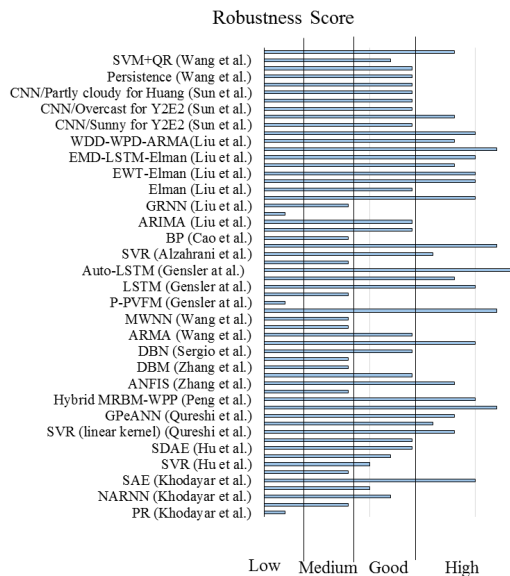

FIGURE 12. Robustness score for energy load prediction methods.

methods. The most effective and accurate models are LSTM methods.

V. CONCLUSION

Nowadays, the importance of prediction and optimization process based on soft computing and CI techniques is undeniable. In the present study, the performance and potential of DL techniques are compared with other CI techniques developed in fields of solar and wind energy resources. Besides, the-state-of-the-art of the methods is described in details. The final approach is to conclude the methods and to compare them. DL techniques have been categorized into two categories, namely, single and hybrid methods, which can be considered as the strength of the present survey. However, these methods differ in precision and timing. It is clear that the most popular factor for comparing results is RMSE and can be considered as the most popular as the correlation coefficient because the closeness of the data is more important than the linearity of them. In this study we also employ different criteria metrics for indicating our findings on comparing different DL techniques and presenting the main findings around the perspective of the study in terms of accuracy, reliability and sustainability. Based on results, DL techniques, in cases of using a large dataset, have the best performance compared with those for other CI techniques, but in cases of using a small dataset, their performance (DL techniques) decreases. In general, the performance of hybrid methods is higher than that for those for single methods and preferably their use is emphasized. In cases where DL techniques are weaker than other CI techniques, the need for using hybrid methods to improve and optimize the structure of the method is essential. Approximately 70% of the articles refer to the importance and high precision of the hybrid methods. Hybrid methods have

been developed in other CI techniques, but there are only a few in DL techniques, which provide the context for work. Besides, a little variety of DL techniques have been employed in solar and wind energies despite the high potential and diversity in DL methods. It is recommended to use hybrid and ensemble DL techniques for modeling, optimizing and categorizing purposes in wind and solar energies. Furthermore, these methods can be employed by policymakers for optimizing or managing the energy use or demand strategies in solar and wind energy sector.

ACKNOWLEDGMENT

The authors would like to thank Keith Downing and Agnar Aamodt for valuable technical comments.

REFERENCES

- [1] K. Fardad, "Producing biogas from medicinal plants," in *Biosystem Engineering*. Ardabil, Iran: Univ. Mohaghegh Ardabili, 2017.
- [2] J. Ghazanfari, B. Najafi, A. S. Faizollahzadeh, and S. Shamshirband, "Limiting factors for the use of palm oil biodiesel in a diesel engine in the context of the ASTM standard," *Cogent Eng.*, vol. 4, no. 1, 2017, Art. no. 1411221.
- [3] S. F. Ardabili, B. Najafi, S. Shamshirband, B. M. Bidgoli, R. C. Deo, and K. Chau, "Computational intelligence approach for modeling hydrogen production: A review," *Eng. Appl. Comput. Fluid Mech.*, vol. 12, no. 1, pp. 438–458, 2018.
- [4] A. Nabavi-Pelesaraei, S. Rafiee, S. S. Mohtasebi, H. Hosseinzadeh-Bandbafha, and K.-W. Chau, "Integration of artificial intelligence methods and life cycle assessment to predict energy output and environmental impacts of paddy production," *Sci. Total Environ.*, vols. 631–632, pp. 1279–1294, Aug. 2018.
- [5] M. E. Bildirici and S. M. Gökmenoğlu, "Environmental pollution, hydropower energy consumption and economic growth: Evidence from G7 countries," *Renew. Sustain. Energy Rev.*, vol. 75, pp. 68–85, Aug. 2017.
- [6] S. Franco, V. R. K. Mandla, and K. R. M. Rao, "Urbanization, energy consumption and emissions in the Indian context A review," *Renew. Sustain. Energy Rev.*, vol. 71, pp. 898–907, May 2017.
- [7] M. B. Jebli and S. Ben Youssef, "The role of renewable energy and agriculture in reducing CO₂ emissions: Evidence for North Africa countries," *Ecological Indicators*, vol. 74, pp. 295–301, Mar. 2017.
- [8] A. Nabavi-Pelesaraei, H. Hosseinzadeh-Bandbafha, P. Qasemi-Kordkheili, H. Kouchaki-Penchah, and F. Riahi-Dorcheh, "Applying optimization techniques to improve of energy efficiency and GHG (greenhouse gas) emissions of wheat production," *Energy*, vol. 103, pp. 672–678, May 2016.
- [9] R. Rostami, S. M. Khoshnava, H. Lamit, D. Streimikiene, and A. Mardani, "An overview of Afghanistan's trends toward renewable and sustainable energies," *Renew. Sustain. Energy Rev.*, vol. 76, pp. 1440–1464, Sep. 2017.
- [10] A. Le Duigou et al., "HYTHEC: An EC funded search for a long term massive hydrogen production route using solar and nuclear technologies," *Int. J. Hydrogen Energy*, vol. 32, nos. 10–11, pp. 1516–1529, 2007.
- [11] L. De Silva Muñoz, A. Bergel, D. Féron, and R. Basséguy, "Hydrogen production by electrolysis of a phosphate solution on a stainless steel cathode," *Int. J. Hydrogen Energy*, vol. 35, no. 16, pp. 8561–8568, 2010.
- [12] D. Ghribi, A. Khelifa, S. Diaf, and M. Belhamel, "Study of hydrogen production system by using PV solar energy and PEM electrolyser in Algeria," *Int. J. Hydrogen Energy*, vol. 38, no. 20, pp. 8480–8490, 2013.
- [13] A. Balabel and M. S. Zaky, "Experimental investigation of solar-hydrogen energy system performance," *Int. J. Hydrogen Energy*, vol. 36, no. 8, pp. 4653–4663, 2011.
- [14] N. F. Yah, A. N. Oumer, and M. S. Idris, "Small scale hydro-power as a source of renewable energy in Malaysia: A review," *Renew. Sustain. Energy Rev.*, vol. 72, pp. 228–239, May 2017.
- [15] M. Kauw, R. M. J. Benders, and C. Visser, "Green methanol from hydrogen and carbon dioxide using geothermal energy and/or hydropower in Iceland or excess renewable electricity in Germany," *Energy*, vol. 90, pp. 208–217, Oct. 2015.
- [16] B. Ashok, R. T. K. Raj, K. Nanthagopal, R. Krishnan, and R. Subbarao, "Lemon peel oil—A novel renewable alternative energy source for diesel engine," *Energy Convers. Manage.*, vol. 139, pp. 110–121, May 2017.
- [17] S. N. Malik and O. R. Sukhera, "Management of natural gas resources and search for alternative renewable energy resources: A case study of Pakistan," *Renew. Sustain. Energy Rev.*, vol. 16, no. 2, pp. 1282–1290, 2012.
- [18] T. Yusaf, S. Goh, and J. A. Borserio, "Potential of renewable energy alternatives in Australia," *Renew. Sustain. Energy Rev.*, vol. 15, no. 5, pp. 2214–2221, 2011.
- [19] A. F. Cristina, C. Manescu, C. Dumitrescu, and N. M. Sirb, "Renewable energy—As future alternative for the Romanian rural communities," *J. Biotechnol.*, vol. 208, pp. S115–S116, 2015. [Online]. Available: <http://www.sciencedirect.com/science/article/pii/S0168165615006100>, doi: 10.1016/j.jbiotec.2015.06.364.
- [20] S. F. Ardabili, A. Mahmoudi, and T. M. Gundoshmian, "Modeling and simulation controlling system of HVAC using fuzzy and predictive (radial basis function, RBF) controllers," *J. Building Eng.*, vol. 6, pp. 301–308, Jun. 2016.
- [21] S. F. Ardabili, A. Mahmoudi, T. M. Gundoshmian, and A. Roshanianfard, "Modeling and comparison of fuzzy and on/off controller in a mushroom growing Hall," *Measurement*, vol. 90, pp. 127–134, Aug. 2016.
- [22] S. F. Ardabili, "Simulation and comparison of control system in mushroom growing rooms environment," M.S. thesis, Dept. Mech. Agricult. Mach. Eng., Univ. Tabriz, Tabriz, Iran, 2014.
- [23] B. Najafi and S. F. Ardabili, "Application of ANFIS, ANN, and logistic methods in estimating biogas production from spent mushroom compost (SMC)," *Resour. Conservation Recycling*, vol. 133, pp. 169–178, Jun. 2018.
- [24] F. Fotovatikhah, M. Herrera, S. Shamshirband, K.-W. Chau, S. F. Ardabili, and M. J. Piran, "Survey of computational intelligence as basis to big flood management: Challenges, research directions and future work," *Eng. Appl. Comput. Fluid Mech.*, vol. 12, no. 1, pp. 411–437, 2018.
- [25] S. F. Ardabili, B. Najafi, H. Ghaebi, S. Shamshirband, and A. Mostafaipoor, "A novel enhanced exergy method in analyzing HVAC system using soft computing approaches: A case study on mushroom growing Hall," *J. Building Eng.*, vol. 13, pp. 309–318, Sep. 2017.
- [26] T. Khatib, A. Mohamed, and K. Sopian, "A review of solar energy modeling techniques," *Renew. Sustain. Energy Rev.*, vol. 16, no. 5, pp. 2864–2869, 2012.
- [27] A. Qazi, H. Fayaz, A. Wadi, R. G. Raj, N. A. Rahim, and W. A. Khan, "The artificial neural network for solar radiation prediction and designing solar systems: A systematic literature review," *J. Cleaner Prod.*, vol. 104, pp. 1–12, Oct. 2015.
- [28] C. Voyant, G. Notton, S. Kalogirou, M.-L. Nivet, C. Paoli, F. Motte, and A. Foulloy, "Machine learning methods for solar radiation forecasting: A review," *Renew. Energy*, vol. 105, pp. 569–582, May 2017.
- [29] R. Ata, "Artificial neural networks applications in wind energy systems: A review," *Renew. Sustain. Energy Rev.*, vol. 49, pp. 534–562, Sep. 2015.
- [30] F. Almonacid, E. F. Fernandez, A. Mellit, and S. Kalogirou, "Review of techniques based on artificial neural networks for the electrical characterization of concentrator photovoltaic technology," *Renew. Sustain. Energy Rev.*, vol. 75, pp. 938–953, Aug. 2017.
- [31] X. Yu, H. Lu, and Q. Liu, "Deep-learning-based regression model and hyperspectral imaging for rapid detection of nitrogen concentration in oilseed rape (*Brassica napus L.*) leaf," *Chemometrics Intell. Lab. Syst.*, vol. 172, pp. 188–193, Jan. 2018.
- [32] L. Zhang, L. Zhang, and B. Du, "Deep learning for remote sensing data: A technical tutorial on the state of the Art," *IEEE Geosci. Remote Sens. Mag.*, vol. 4, no. 2, pp. 22–40, Jun. 2016.
- [33] E. C. Akbaba, E. Yüce, and B. G. Akinoglu, "Deep learning algorithm applied to daily solar irradiation estimations," in *Proc. 6th Int. Renew. Sustain. Energy Conf. (IRSEC)*, Dec. 2018, pp. 1–4.
- [34] T. A. M. H. Nagem, R. Qahwaji, and S. Ipson, "Deep learning technology for the prediction of solar flares from GOES data," in *Proc. Comput. Conf.*, Jul. 2017, pp. 697–700.
- [35] M. Aakroum, A. Ahogho, A. Aaqir, and A. A. Ahajjam, "Deep learning for inferring the surface solar irradiance from sky imagery," in *Proc. Int. Renew. Sustain. Energy Conf. (IRSEC)*, Dec. 2017, pp. 1–4.
- [36] A. Muhammad, J. M. Lee, S. W. Hong, S. J. Lee, and E. H. Lee, "Deep learning application in power system with a case study on solar irradiation forecasting," in *Proc. Int. Conf. Artif. Intell. Inf. Commun. (ICAIC)*, Feb. 2019, pp. 275–279.
- [37] J. Tao, Y. Zhu, and Q. Fan, "Model predictive control for a class of systems with isolated nonlinearity," *ISA Trans.*, vol. 53, no. 4, pp. 1343–1349, 2014.

- [38] R. R. B. de Aquino, J. C. Albuquerque, O. N. Neto, M. M. S. Lira, A. A. Ferreira, and A. C. Neto, "Influence of deep learning on precision improvement in predictive models of wind power generation," in *Proc. Int. Conf. Comput. Sci. Comput. Intell. (CSCI)*, Dec. 2017, pp. 832–835.
- [39] J. Cao and X. Lin, "Study of hourly and daily solar irradiation forecast using diagonal recurrent wavelet neural networks," *Energy Convers. Manage.*, vol. 49, no. 6, pp. 1396–1406, 2008.
- [40] A. T. Sergio and T. B. Ludermir, "Deep learning for wind speed forecasting in northeastern region of Brazil," in *Proc. Brazilian Conf. Intell. Syst. (BRACIS)*, Nov. 2015, pp. 322–327.
- [41] M. Khodayar and M. Teshnehlab, "Robust deep neural network for wind speed prediction," in *Proc. 4th Iranian Joint Congr. Fuzzy Intell. Syst. (CFIS)*, Sep. 2015, pp. 1–5.
- [42] Y. Liu and H. Zhang, "An empirical study on machine learning models for wind power predictions," in *Proc. 15th IEEE Int. Conf. Mach. Learn. Appl. (ICMLA)*, Dec. 2016, pp. 758–763.
- [43] X. Peng, L. Xiong, J. Wen, Y. Xu, W. Fan, S. Feng, and B. Wang, "A very short term wind power prediction approach based on multilayer restricted Boltzmann machine," in *Proc. IEEE PES Asia-Pacific Power Energy Eng. Conf. (APPEEC)*, Oct. 2016, pp. 2409–2413.
- [44] C. Wan, Z. Xu, P. Pinson, Z. Y. Dong, and K. P. Wong, "Probabilistic forecasting of wind power generation using extreme learning machine," *IEEE Trans. Power Syst.*, vol. 29, no. 3, pp. 1033–1044, May 2014.
- [45] H. Z. Wang, G. B. Wang, G. Q. Li, J. C. Peng, and Y. T. Liu, "Deep belief network based deterministic and probabilistic wind speed forecasting approach," *Appl. Energy*, vol. 182, pp. 80–93, Nov. 2016.
- [46] Q. Hu, R. Zhang, and Y. Zhou, "Transfer learning for short-term wind speed prediction with deep neural networks," *Renew. Energy*, vol. 85, pp. 83–95, Jan. 2016.
- [47] A. Gensler et al. (2016). *GermanSolarFarm Data Set*. [Online]. Available: <http://ies-research.de/Software>
- [48] A. Gensler, J. Henze, B. Sick, and N. Raabe, "Deep learning for solar power forecasting—An approach using autoencoder and LSTM neural networks," in *Proc. IEEE Int. Conf. Syst., Man, Cybern. (SMC)*, Oct. 2016, pp. 2858–2865.
- [49] A. Alzahrani, P. Shamsi, C. Dagli, and M. Ferdowsi, "Solar irradiance forecasting using deep neural networks," *Procedia Comput. Sci.*, vol. 114, pp. 304–313, 2017. [Online]. Available: <http://www.sciencedirect.com/science/article/pii/S1877050917318392>, doi: 10.1016/j.procs.2017.09.045.
- [50] H. Z. Wang, G.-Q. Li, G.-B. Wang, J.-C. Peng, H. Jiang, and Y.-T. Liu, "Deep learning based ensemble approach for probabilistic wind power forecasting," *Appl. Energy*, vol. 188, pp. 56–70, Feb. 2017.
- [51] A. S. Qureshi, A. Khan, A. Zameer, and A. Usman, "Wind power prediction using deep neural network based meta regression and transfer learning," *Appl. Soft Comput.*, vol. 58, pp. 742–755, Sep. 2017.
- [52] D. Lee, D. Cisek, and S. Yoo, "Sensor network-based wind field estimation using deep learning," in *Proc. New York Sci. Data Summit (NYSDS)*, New York, NY, USA, Aug. 2017, pp. 1–3.
- [53] D. Díaz-Vico, A. Torres-Barrán, A. Omari, and J. R. Dorronsoro, "Deep neural networks for wind and solar energy prediction," *Neural Process. Lett.*, vol. 46, no. 3, pp. 829–844, 2017.
- [54] H. Liu, X.-W. Mi, and Y.-F. Li, "Wind speed forecasting method based on deep learning strategy using empirical wavelet transform, long short term memory neural network and elman neural network," *Energy Convers. Manage.*, vol. 156, pp. 498–514, Jan. 2018.
- [55] D. E. O'Leary, "Artificial intelligence and big data," *IEEE Intell. Syst.*, vol. 28, no. 2, pp. 96–99, Mar./Apr. 2013.
- [56] A. Kalantari, A. Kamsin, S. Shamshirband, A. Gani, H. Alinejad-Rokny, and A. T. Chronopoulos, "Computational intelligence approaches for classification of medical data: State-of-the-art, future challenges and research directions," *Neurocomputing*, vol. 276, pp. 2–22, Feb. 2018.
- [57] M. I. Budyko, "The effect of solar radiation variations on the climate of the Earth," *Tellus*, vol. 21, no. 5, pp. 611–619, 1969.
- [58] B. Yelmen and M. T. Çakir, "Estimation of average monthly total solar radiation on horizontal surface for mediterranean region," *Energy Sources, A, Recovery, Utilization, Environ. Effects*, vol. 37, no. 5, pp. 543–551, 2015.
- [59] L. Zou, L. Wang, L. Xia, A. Lin, B. Hu, and H. Zhu, "Prediction and comparison of solar radiation using improved empirical models and adaptive neuro-fuzzy inference systems," *Renew. Energy*, vol. 106, pp. 343–353, Jun. 2017.
- [60] O. Alavi and K. Mohammadi, and A. Mostafaeipour, "Evaluating the suitability of wind speed probability distribution models: A case of study of east and southeast parts of Iran," *Energy Convers. Manage.*, vol. 119, pp. 101–108, Jul. 2016.
- [61] K. Mohammadi and A. Mostafaeipour, "Using different methods for comprehensive study of wind turbine utilization in Zarrineh, Iran," *Energy Convers. Manage.*, vol. 65, pp. 463–470, Jan. 2013.
- [62] F. Fazelpour, N. Soltani, S. Soltani, and M. A. Rosen, "Assessment of wind energy potential and economics in the north-western Iranian cities of Tabriz and Ardabil," *Renew. Sustain. Energy Rev.*, vol. 45, pp. 87–99, May 2015.
- [63] *Global Wind 2015 Report: Annual Market Update*, Global Wind Energy Council, Brussels, Belgium, 2016.
- [64] Q. Zhang, L. T. Yang, Z. Chen, and P. Li, "A survey on deep learning for big data," *Inf. Fusion*, vol. 42, pp. 146–157, Jul. 2018.
- [65] Y. LeCun, L. Bottou, Y. Bengio, and P. Haffner, "Gradient-based learning applied to document recognition," *Proc. IEEE*, vol. 86, no. 11, pp. 2278–2324, Nov. 1998.
- [66] A. Deshpande. (2016). *A Beginner's Guide To Understanding Convolutional Neural Networks*. [Online]. Available: <https://adeshpande3.github.io/A-Beginner%27s-Guide-To-Understanding-Convolutional-Neural-Networks/>
- [67] A. Krizhevsky, I. Sutskever, and G. E. Hinton, "ImageNet classification with deep convolutional neural networks," in *Proc. Adv. Neural Inf. Process. Syst.*, 2012, pp. 1097–1105.
- [68] Y. Sun, G. Szűcs, and A. R. Brandt, "Solar PV output prediction from video streams using convolutional neural networks," *Energy Environ. Sci.*, vol. 11, no. 7, pp. 1811–1818, 2018.
- [69] M. Á. Carreira-Perpiñán and G. E. Hinton, "On contrastive divergence learning," in *Proc. 10th Int. Workshop Artif. Intell. Statist. Bridgetown, Barbados: Society for Artificial Intelligence and Statistics*, Jan. 2005, pp. 1–8. [Online]. Available: <http://www.gatsby.ucl.ac.uk/aistats/>
- [70] J. Ngiam, Z. Chen, P. W. Koh, and A. Y. Ng, "Learning deep energy models," in *Proc. 28th Int. Conf. Mach. Learn. (ICML)*, 2011, pp. 1105–1112.
- [71] A. de Giorgio, "A study on the similarities of deep belief networks and stacked autoencoders," Tech. Rep., 2015. [Online]. Available: [http://kth.diva-portal.org/smash/record.jsf?pid=diva2%3A859006& dswid=5511](http://kth.diva-portal.org/smash/record.jsf?pid=diva2%3A859006&dswid=5511)
- [72] I. Arel, D. C. Rose, and T. P. Karnowski, "Deep machine learning—a new Frontier in artificial intelligence research," *IEEE Comput. Intell. Mag.*, vol. 5, no. 4, pp. 13–18, Nov. 2010.
- [73] H. Lee, C. Ekanadham, and A. Y. Ng, "Sparse deep belief net model for visual area V2," in *Proc. Adv. Neural Inf. Process. Syst.*, 2008, pp. 873–880.
- [74] H. Lee, R. Grosse, R. Ranganath, and A. Y. Ng, "Unsupervised learning of hierarchical representations with convolutional deep belief networks," *Commun. ACM*, vol. 54, no. 10, pp. 95–103, Oct. 2011.
- [75] L. Younes, "On the convergence of Markovian stochastic algorithms with rapidly decreasing ergodicity rates," *Stochastics, Int. J. Probab. Stochastic Processes*, vol. 65, nos. 3–4, pp. 177–228, 1999.
- [76] R. Salakhutdinov and H. Larochelle, "Efficient learning of deep Boltzmann machines," in *Proc. 13th Int. Conf. Artif. Intell. Statist.*, 2010, pp. 693–700.
- [77] G. E. Hinton and R. R. Salakhutdinov, "A better way to pretrain deep Boltzmann machines," in *Proc. Adv. Neural Inf. Process. Syst.*, 2012, pp. 2447–2455.
- [78] K. Cho, T. Raiko, A. Ilin, and J. Karhunen, "A two-stage pretraining algorithm for deep Boltzmann machines," in *Proc. Int. Conf. Artif. Neural Netw.* Berlin, Germany: Springer, 2013, pp. 106–113.
- [79] G. Montavon and K.-R. Müller, "Deep Boltzmann machines and the centering trick," in *Neural Networks: Tricks of the Trade*. Cham, Switzerland: Springer, 2012, pp. 621–637.
- [80] I. J. Goodfellow, A. Courville, and Y. Bengio, "Joint training deep Boltzmann machines for classification," 2013, *arXiv:1301.3568*. [Online]. Available: <https://arxiv.org/abs/1301.3568>
- [81] C.-Y. Zhang, C. L. P. Chen, M. Gan, and L. Chen, "Predictive deep Boltzmann machine for multiperiod wind speed forecasting," *IEEE Trans. Sustain. Energy*, vol. 6, no. 4, pp. 1416–1425, Oct. 2015.
- [82] C.-Y. Liou, W.-C. Cheng, J.-W. Liou, and D.-R. Liou, "Autoencoder for words," *Neurocomputing*, vol. 139, pp. 84–96, Sep. 2014.
- [83] G. E. Hinton and R. R. Salakhutdinov, "Reducing the dimensionality of data with neural networks," *Science*, vol. 313, no. 5786, pp. 504–507, 2006.



SHAHAB SHAMSHIRBAND is a Postdoctoral Research Fellow of the Department of Computer Science. He is currently a member of the Data and Artificial Intelligence (DART) Group and also with the Open AI Laboratory, Norwegian University Science and Technology. He has supervised or cosupervised bachelor's degree and master's degree students by research and training. He has participated in many research programs with the Center for Big Data Analysis, IUST, and IAU.

Since 2009, he has been associated with young researchers and elite club. He is the author or coauthor of articles published in IF journals and attended to a high rank A and B conferences. His research interests include machine learning and the IoT-security.

Dr. Shamshirband is a Professional Member of the IEEE and ACM. He is an Associate Editor, a Guest Editor, and a Reviewer of high-quality journals. He is an Associate Editor of IEEE Access.



TIMON RABCUK has an h-index 44 in the core collection of ISI Web of Science, listed in ISI highly-cited researchers, in 2014 and 2015, and the categories computer science and engineering. He is the Chair of computational mechanics currently consisting of 38 scientific co-workers (30 Ph.D. students, 8 Postdoctorals, 2 secretaries) with Bauhaus University Weimar. His research interests include computational mechanics particularly the development of computational methods

(XFEM), meshfree methods such as EFG, LME, SPH, and IRBFN, cracking particle methods, smoothed nite elements, phantom node method, peridynamics, isogeometric analysis, phase-field models, remeshing techniques, adaptive methods, hierarchical, semi-concurrent and concurrent multiscale methods, QM and MS/MD, coarse-grained models and parameterization of atomistic potentials, model order reduction methods (POD), stochastic methods, and uncertainty analysis and (topology) optimization. His research on developing computational methods includes moving boundary/interface problems, especially for fracture and also uid-structure interaction.



KWOK-WING CHAU is currently Professor with the Department of Civil and Environmental Engineering, The Hong Kong Polytechnic University. The scope of his research interest is very broad, covering numerical flow modeling, water quality modeling, hydrological modeling, knowledge-based system development, and artificial intelligence applications. He has published over 230 science-citation index journal articles and the total number of citations is over 12 000. He

has acquired many prestigious research awards including the 2008 Natural Science Class 1 Award conferred by Ministry of Education of China, the 2009 National Natural Science Class 2 Award, and the 2018 Highly-Cited Researcher by Clarivate Analytics.

• • •