

Received June 24, 2019, accepted July 4, 2019, date of publication July 12, 2019, date of current version July 30, 2019.

Digital Object Identifier 10.1109/ACCESS.2019.2928481

IoT-BBMS: Internet of Things-Based Baby Monitoring System for Smart Cradle

WAHEB A. JABBAR^{1,2}, (Senior Member, IEEE), **HIEW KUET SHANG**¹,
SAIDATUL N. I. S. HAMID¹, **AKRAM A. ALMOHAMMEDI**³,
ROSHAHLIZA M. RAMLI¹, (Member, IEEE), AND
MOHAMMED A. H. ALI⁴, (Member, IEEE)

¹Faculty of Engineering Technology, Universiti Malaysia Pahang, Gambang 26300, Malaysia

²IBM Centre of Excellence, Universiti Malaysia Pahang, Gambang 26300, Malaysia

³Department of Computer and Communication Engineering, Universiti Putra Malaysia, Serdang 43400, Malaysia

⁴Faculty of Mechanical and Manufacturing Engineering, Universiti Malaysia Pahang, Pekan 23300, Malaysia

Corresponding author: Waheb A. Jabbar (waheb@ieee.org)

This work was supported in part by the Ministry of Education, Malaysia, under Grant FRGS/1/2018/TK04/UMP/02/11 (RDU190133), and in part by the Universiti Malaysia Pahang (UMP) under Grant RDU190304.

ABSTRACT The current number of working mothers has greatly increased. Subsequently, baby care has become a daily challenge for many families. Thus, most parents send their babies to their grandparents' house or to baby care houses. However, the parents cannot continuously monitor their babies' conditions either in normal or abnormal situations. Therefore, an Internet of Things-based Baby Monitoring System (IoT-BBMS) is proposed as an efficient and low-cost IoT-based system for monitoring in real time. We also proposed a new algorithm for our system that plays a key role in providing better baby care while parents are away. In the designed system, Node Micro-Controller Unit (NodeMCU) Controller Board is exploited to gather the data read by the sensors and uploaded via Wi-Fi to the AdaFruit MQTT server. The proposed system exploits sensors to monitor the baby's vital parameters, such as ambient temperature, moisture, and crying. A prototype of the proposed baby cradle has been designed using Nx Siemens software, and a red meranti wood is used as the material for the cradle. The system architecture consists of a baby cradle that will automatically swing using a motor when the baby cries. Parents can also monitor their babies' condition through an external web camera and switch on the lullaby toy located on the baby cradle remotely via the MQTT server to entertain the baby. The proposed system prototype is fabricated and tested to prove its effectiveness in terms of cost and simplicity and to ensure safe operation to enable the baby-parenting anywhere and anytime through the network. Finally, the baby monitoring system is proven to work effectively in monitoring the baby's situation and surrounding conditions according to the prototype.

INDEX TERMS Baby monitoring, smart cradle, NodeMCU, AdaFruit, MQTT.

I. INTRODUCTION

At present, female participation in the work force in the industrialized nations has greatly increased, thereby affecting infant care in many families. Both parents are required to work due to the high cost of living. However, they still need to look after their babies, thereby increasing workload and stress, especially of the mother. Working parents cannot always care for their babies. They either send their babies to their parents or hire a baby caregiver while they are working. Some parents worry about the safety of their babies in the

care of others. Thus, they go home to check on their babies during their free time, such as lunch or tea break. A baby monitoring system that can monitor the babies' condition real time is proposed to solve these problems. A baby monitoring system consisting of a video camera and microphone without limitations of coverage. It can send data and immediately notify the parents about urgent situations, thereby shortening the time needed to handle such scenarios. Generally, babies cry because they are hungry, tired, unwell, or need their diaper changed.

Sudden Infant Death Syndrome (SIDS) is also known as crib death, because many babies who die of SIDS, are found in their cribs. It occurs to infants younger than 12 months old.

The associate editor coordinating the review of this manuscript and approving it for publication was Pietro Savazzi.

Most SIDS deaths occur in infants younger than 6 months old [1]. Professionals still do not know the causes of SIDS, but risk can be reduced by letting the baby sleep on a firm surface (crib mattress). In addition, the baby should not sleep on a pillow or another a soft surface. The researchers do not know why sleeping on such surfaces increase the risk of SIDS, but they warn that it could be dangerous [2]. For instance, in 2003, a showed that placing an infant to sleep on soft bedding rather than on firm bedding appeared to pose five times the risk of SIDS [3]. Moreover, overheating should be avoided during sleep. Babies should be kept warm during sleep, but the temperature should not be extremely warm. In winter or cold weather, the risk of SIDS increases, because the parents overdress their babies or place them under heavier blanket, thereby overheating them [4]. Therefore, if the room temperature is comfortable for an adult, then it is also appropriate for the baby.

Internet of Things (IoT) simply refers to a network of objects that are connected to the internet. It provides devices with the ability to transfer sensor data on the Internet without requiring intervention [5], [6]. The IoT encompasses many devices and is growing at a rapid rate, because it is such a broad category. A forecast states that in 2019, approximately 26.66 billion IoT devices will be active; by 2025, 75 Billion IoT devices worldwide will be available and wirelessly connected to the Internet [7], [8]. Among these connected devices, millions of wearable sensors are widely used in healthcare applications [9]. The total global spending on the IoT in 2016 was 737 billion dollars and was projected to reach 1.29 trillion dollars in 2020. IoT is a prominent field that will increase and grow exponentially [10], [11]. The function of IoT is control, real-time monitoring, and perform autonomy or autonomous function and optimization. Perhaps one of the main reasons why the IoT is extremely large is that it aims to make life more convenient, and people are more likely to invest in things that make their lives easier. Accordingly, the number of IoT applications continues to increase in different fields. In this study, IoT is integrated into our baby monitoring system to achieve a rapid response time and to provide a greater sense of security for parents.

Node Micro-Controller Unit (NodeMCU) Wi-Fi-Based Controller Board is an open source platform for IoT applications and is used as the main micro-controller in this project. It is used to gather data read by the sensors and uploads these data to the MQTT server. It also receives commands given by the user to perform specific tasks via the MQTT server. NodeMCU consists of physical programmable circuit board similar to that of any other development boards, such as Arduino board and Raspberry Pi. The programming of the NodeMCU can be performed using Arduino software, which is an Integrated Development Environment (IDE), where the code of instructions is written and the micro-controller is uploaded.

Generally, the baby cradle (Figure 1) is used in various hospitals and maternity homes for infants to sleep in and for soothing them. Conventional cradles are used in



FIGURE 1. Conventional baby cradle.

villages or non-urban areas because of their low cost and simplicity. However, conventional cradles are manually swung and require manpower. They lack automation and are not electronically equipped. Consequently, conventional cradles should be automated to become more convenient, safe, and efficient in monitoring the baby's situation in real time.

The remainder of this paper is structured as follows. The next section introduces the background and related works. Section III presents the design and fabrication of smart cradle. The details of the developed IoT-BBMS system architecture, implementation, and functionalities are explained in Section IV. The results and discussion are highlighted in Section V. Finally, the conclusion drawn is presented in Section VI.

II. BACKGROUND AND RELATED WORKS

A. MOTIVATIONS AND PROBLEM STATEMENT

Under fast-paced life conditions, everyone is busy in their professional life including parents. They leave the house early in the morning and come back before dinner time. Even the mothers are working. Thus, they do not have sufficient time to take care of their babies. Not all parents could afford a nanny to help them with their children. Then, after working for long hours, the mothers still have to manage the house and take care of their babies simultaneously.

Parents might not have the time to soothe their baby to sleep or rock their baby back to sleep in the middle of the night. Studies about the effect of rocking a baby have been carried out and found that babies sleep better while being rocked or swung lightly because the rhythmic movement mimics the gentle rocking they felt while in their mothers' womb. Most available automated cradles are designed to rock non-stop. However, the rocking movement can make the baby nauseous and uncomfortable. Thus, allowing the automated cradle to rock the baby to sleep in the middle of the night is also a problem.

Furthermore, some parents place their baby in a separate room. Therefore, parents could not hear the baby crying and could not be there to ease their baby back to sleep in the middle of the night. Other parents may be occupied with house chores. Thus, because they cannot hear their baby

crying, they cannot attend to them immediately. Sometimes, the baby only needs a little distraction to return to deep sleep. Several types of baby cradles are available in stores, but they are expensive, and not everyone can afford them. In addition, the existing automatic cradles in the literature have many limitations in terms of functionality, cost, and communication technology support [12]–[15]. To the best of our knowledge, no previous studies have developed a smart cradle with IoT support from scratch, similar to that in the present study. To overcome this problem, a new automatic IoT-based baby monitoring system (IoT-BBMS) is designed, allowing the parents to access an account to monitor the baby's condition anywhere and anytime.

B. RESEARCH CONTRIBUTIONS

To address these challenges, we designed and fabricated a baby monitoring system for a smart cradle using NodeMCU as the microcontroller while the system was developed using Arduino IDE. This system consists of a cradle that can swing whenever the sound sensor detects crying. A mini fan is attached on top of the cradle to provide ventilation. The mini fan and the swinging of the cradle can be switched on either by the sensors or through remote control from the MQTT server. An external Wi-Fi camera has been installed on the cradle to enable real-time vision monitoring. The parents can see the baby's condition and talk to the baby using the ready-made mobile application of the Wi-Fi camera. An Internet of Things-based baby monitoring system for smart cradle is proposed in this paper. The novelty of this work lies in the proposed IoT-BBMS automation system by adopting the following methodology and contributions:

- (i) A smart baby cradle prototype is designed and fabricated with auto-swinging support, web camera and musical toy to test the proposed system.
- (ii) A new Algorithm is proposed and implemented in NodeMCU controller to perform the required monitoring and control tasks.
- (iii) Utilizing the NodeMCU as the microcontroller and Adafruit MQTT as IoT server to retrieve data from sensors and send commands to actuators.

The system could gather accurate real-time data and response by actuating the proper relay to switching fan, toys and swinging motor.

C. RELATED WORKS

Few studies have investigated the possibilities of automated baby cradle using different perspectives. A baby monitoring system has been proposed in [16], in which an enhanced noise cancelling system that monitors the baby and reduces sound pollution has been suggested. The main function of the system is to reduce the noise that might disturb the baby by playing relaxing songs. This system can also adjust the room's light intensity with the aid of a light sensor. However, our system has more advanced features, such as supporting real-time monitoring over the IoT network and vision monitoring using web camera.

Goyal and Kumar [17] introduced an E-baby cradle that can swing automatically when it detects crying and stops swinging when the crying stops. The speed for the swinging cradle can be controlled based on the user's need. It has an alarm embedded in the system, which notifies the user when two conditions occurred. First, the alarm goes off when the mattress is wet, indicating that the mattress should be changed. Second, when the baby does not stop crying for a certain time, the alarm alerts the parents to attend to their baby. However, it is only applicable when parents are near the cradle, because it only uses a buzzer alarm, the sound of which might frighten the baby. Parents cannot monitor their baby when they are away from home, for example when at work or when traveling to other places.

A similar automatic baby monitoring system was proposed in [18]. The authors developed a low-budget system that swings the cradle when the crying sound is detected, and the cradle stops when the baby stops crying. The built-in alarm goes off under either one of the following conditions: the mattress is wet or the baby does not stop crying after a certain period. A video camera is placed above the cradle to monitor the baby. However, the parents can only receive the notification via SMS and cannot control the system. Therefore, the proposed system in the current study is more advanced, because it utilizes an IoT application to monitor and control the developed smart cradle in real time anywhere and anytime.

An Arduino-based resonant cradle designed with infant cry recognition was proposed by [19]. A ball bearing design is adopted to reduce system damping and allows the cradle to swing freely even without electricity. Subsequently, an appropriate sensor is designed to detect the swinging status or angle. The authors claimed that their system is energy saving and allows parents to record infant cries due to hunger or pain on an SD card stored in an SD module. However, such local control solution is inappropriate when parents are located slightly far from their babies, because it does not allow updating of the data in the IoT server or controlling the cradle remotely.

Reference [20] designed a system for baby monitoring based on Raspberry Pi and Pi camera. The designed system can spot the motion and crying condition of the baby. They used condenser MIC to spot the crying condition and PIR motion sensor to spot the baby movement with the help of Pi camera. The camera is turned on only when the condenser MIC detects a sound and sends a signal to Raspberry Pi. However, the output of this system is only available on monitor display; thus, the parents can only view the data on a limited number of devices within a fixed area.

In [21], Kaur and Jasuja proposed a system that can monitor the pulse rate and body temperature of the person. Dedicated sensors are placed along with Raspberry Pi and IoT to monitor the health condition and store the obtained data to Bluemix cloud. The data stored are sent to a doctor for health analysis and to detect abnormalities. The KG011 sensor is used to measure the heart rate, and the DS18B20 sensor

is used to measure the temperature. Then, the readings are shown in the IBM Watson IoT Platform in graph form. The article proposed a good point, which is about using the sensors to send data to the IoT platform. However, this system is unsuitable for infants, because their bodies' immune system is weaker than that of adults. This wearable system might emit some radiation that could harm the infants and cause some side effects.

A baby condition monitoring system based on GSM network was proposed in [22]. The authors built a prototype that can measure infants' pulse rate, body temperature, movement, and moisture condition and send information through GSM network. It consists of sensors, LCD screen, GSM interface, and buzzer, which are controlled by a PIC 18f4520 8-bit microcontroller. The LCD module displays the sensor readings, and the GSM interface sends an SMS alert to the parent's mobile number. Although the system was proposed to monitor the baby's condition, appropriate control actions are required to make accurate readings, given that the baby could have crawled around and the sensors might have been detached. The baby might also get injured or electrocuted when the unattended baby touches the system circuit. The system should be improved in terms of safety, cost effectiveness, and user-friendliness.

Saadatian *et al.* [23] proposed a mobile-based system that updates parents about the infants' status. The system measures the temperature, motion, and heart rate, and then sends the data to a server to be analyzed. The analyzed data will then be sent to the parents and generate alert if any abnormality is found. The parents will receive an advisory first-aid information for immediate action, and a nearby clinic will be notified by the system. The system was tested on adults during the prototype stage by collecting data for analysis. The developed system uses Bluetooth as a communication technology, which is limited in range and data rate. Such a system is only applicable for short-distance baby devices. The system does not support the IoT solution, remote control, and vision monitoring as in our proposed system.

In [24], a monitoring system was developed for an incubator. A pulse sensor is attached to an infant to measure the infant's pulse rate, and a humidity sensor is used to measure the humidity level. The recorded data will be sent to the computer through Arduino microcontroller, where the data can be referred by the Neonatal Intensive Care Unit (NICU) personnel for diagnostic purposes. An alarm system is designed to send an alarm whenever the data readings reach a dangerous level to prevent the occurrence of a dangerous situation. The system underwent tests on infants aged 0–3 months, 3–6 months, and 6–12 months. However, the data recorded were only transferred directly to the computer. This approach can be improved by adding a Wi-Fi module to send data via the internet to monitor the infants' conditions anywhere and anytime.

Reference [25] presented an ARM embedded platform project for baby monitoring. The author proposed a system consisting of embedded system platform with a Linux kernel,

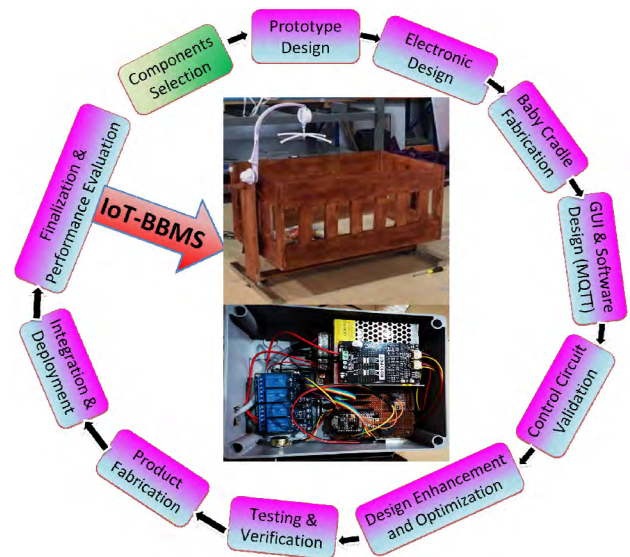

FIGURE 2. Flowchart of research activities.

CMOS image sensor, and control system. The system is used to monitor the baby's activities and room environment through a web browser. If the system detects a baby's cry, then it will alert the parents by transmitting the audio signal to the parents' room. The infant's body temperature is measured by a TMP75 temperature sensor together with a wireless module to send temperature readings to the platform. A bi-directional triode thyristor is used as power regulation component in light control unit. An LCD display module is used to display the measured readings. This project can be improved by designing a cradle installed with control system, which would allow the cradle to swing on its own when the baby cries.

III. DESIGN AND FABRICATION OF SMART CRADLE

A. RESEARCH METHODOLOGY

The overall methodology adopted in this research is shown in Figure 2. Issues in the existing systems were identified by conducting a comprehensive literature review on studies related to baby monitoring systems. Then, we introduced a smart cradle that combines the concept of IoT with baby monitoring system. Subsequently, the selection of material for the smart cradle was carried out. All the hardware and materials used in building this system, which were suitable for a baby, were selected. The priority is to ensure the safety of the baby. The modelling phase is followed by the system design, determining the GUI of applications, and prototype phase. The system design is separated into two phases, namely, the cradle design and control system design. A cradle prototype for the baby monitoring system was designed. In the control system design, the types of electronic components were determined and purchased for implementation in the system. Then, coding was performed according to how the system was proposed. After the modelling phase, the designed baby monitoring system was then enhanced and optimized through several tests to achieve the expected outcome. Subsequently,

the system was installed on the cradle prototype for the testing phase before finalizing the smart cradle. When the testing failed due to some coding errors or other problems, the testing phase was repeated until the cradle achieved the expected outcome that satisfied the research objectives.

B. COMPONENT SELECTION

The information regarding the components required in the baby cradle was decided to ensure that they can be installed without errors. We also surveyed available baby cradles that included a baby monitoring system in the market to gain some insights into the structure of the baby cradle. During this phase, the hardware and software components used in this study were selected.

The hardware components included the following:

- NodeMCU ESP8266 Wi-Fi Controller Board
- 12V DC Power source
- Four-channel 5 V relay module
- Sound sensor module
- Temperature and humidity sensor
- Mini fan
- 12 V DC geared motor
- Wireless security camera
- Baby cradle

The software components include the following:

- Nx Siemens software
- Fritzing software
- Proteus Stimulation
- Arduino IDE software
- MQTT Protocol server

After the selection process of the components, we designed and fabricated the baby cradle, into which IoT-BBMS was subsequently installed.

C. CRADLE DESIGN

Every product needs a complete design with exact measurement before it can be fabricated. The design plays a fundamental role in this project. Therefore, prior to the design process, a few criteria were considered. The design of the baby cradle shown in Figure 3 was created by using NX10. We visualized our entire sketch by using a more practical picture. For this baby cradle, we designed the cradle dimensions and the main components, which allowed swinging and attachment of the developed monitoring system. The details of the designed parts and their features are listed in TABLE 1 in the Appendix.

Material selection is a core step in the process of designing any physical object. The systematic selection of the best material for the given application begins with the properties and costs of candidate materials. Selecting the appropriate material is one of the keys that lead to success. Our wooden baby cradle is made of red meranti wood. Wood is used mainly for its eco-friendly property. It was designed as a classic baby cradle but with the latest technology.

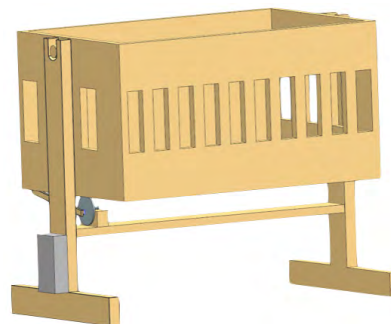

FIGURE 3. Baby cradle design.

Meranti wood is softer than other woods, and it eases the process of building the prototype.

The baby cradle is rectangular in shape and has fences that keep the baby from falling off the front and side. The baby can still look outside from their cradle. The back side is similar to a door, but it does not operate sideways and it moves to 90 degrees from the initial state. A latch is used to close and attach the cradle. The designed baby cradle is a 2-in-1 type. It can be an improvised baby cradle with technology attached. It can also be a changing table, because the back side of the cradle can be moved down, thereby transforming it into a table. Hence, it is easier for the end-user to change the baby's diaper or clothes. This design is also suitable for babies 2 years old and older.

D. BABY CRADLE FABRICATION

During the manufacturing process, the materials were constructed by combining the parts and components to obtain the finished product. The fabrication concept always involved the process of assembly. The fabrication started with shop drawings, including precise measurements. Then, the fabrication stage was completed, and finally, the installation of the final project was done. Value-added processes, including cutting, paneling, drilling, sawing, forming, 3D printing, and machining, were performed in the workshop.

The wood underwent a planing process to avoid wood chips prior to the cutting and assembly process. The underlying principle involved cleaning and flattening the wood surface of the cutter mark to obtain a flat surface and 90° angle of the four sides of the wood. Wood thickness was less than 1 inch. Wood surface was smoothed after coming out of the kiln dry. The casing of the sensor was made by 3D printing. After completing the cutting and the 3D processes, all the pieces were joined based on the design made by using the NX10 software.

The assembling process was performed using glue, screw, and nut, which hold all parts of the baby cradle including its legs and electrical parts. Every part had to be secured by glue to ensure strength and durability. The fabrication process is illustrated in Figure 4. Four rotating wheels with locks on each wheel were used in the baby cradle prototype to allow it to move around the house of the user. The rotating wheels, shown in Figure 5 (a), are installed in the four corners below

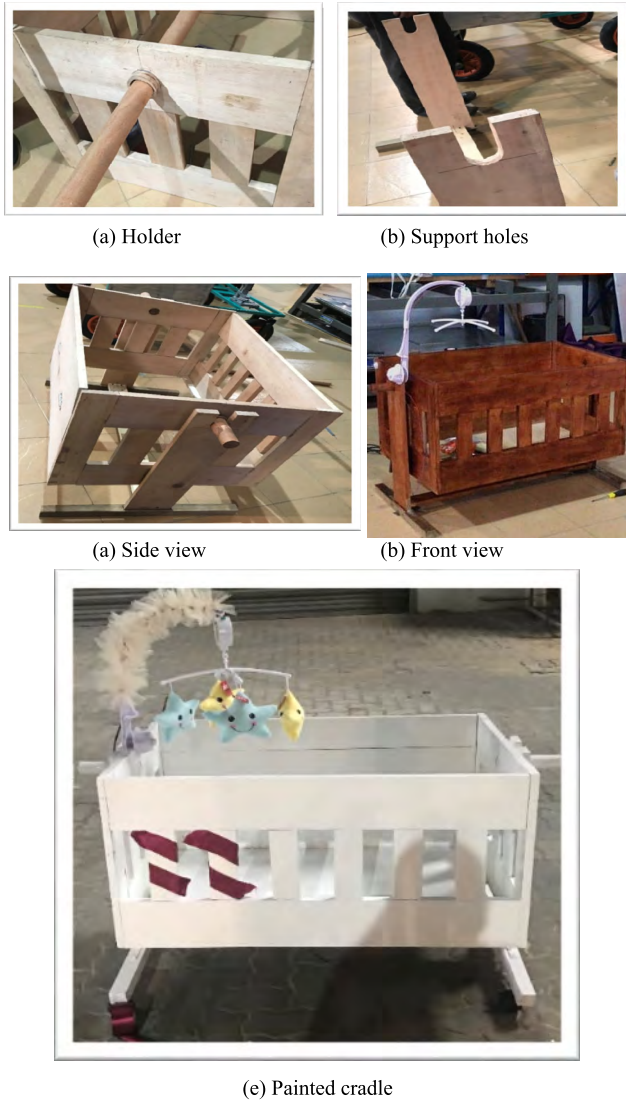

FIGURE 4. Cradle fabrication process.

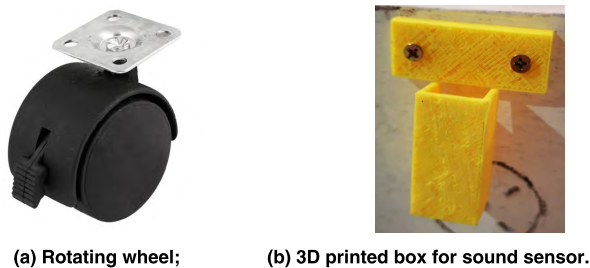

FIGURE 5. (a) Rotating wheel; (b) 3D printed box for sound sensor.

the prototype. Whenever the baby is placed in the cradle, the user must lock the wheels of the cradle to prevent cradle movement. The wheels could be unlocked or locked based on the user's preference.

The entire baby cradle was finished with shellac in pine wood color. However, the color is unattractive, so we changed it. We used white color decorated with a maroon ribbon, and

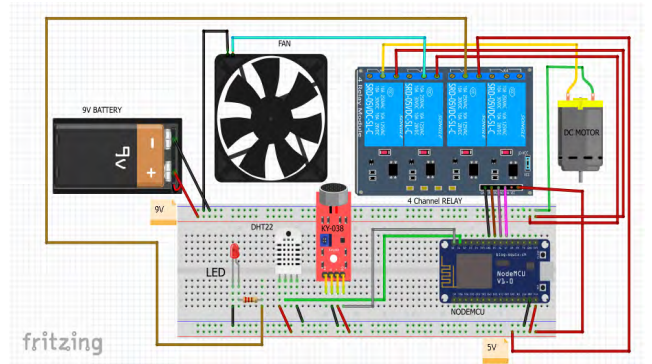

FIGURE 6. Component circuit diagram.

then placed the baby bed. We layered the paint four times to ensure that all parts of the wood are totally covered. A sound sensor is placed at the top of the baby cradle to enable sound detection. A small box was 3D printed using a 3D printer with a dimension that fitted the sound sensor. The small box, shown in Figure 5(b), is then screwed to the inner-side of the baby cradle to fix the location of the sound sensor.

This baby cradle has a rectangular shape, and the fences consist of seven small bars that will prevent falls, but still allow the baby to look out from the cradle. It has a curved shape, indicating that the base is smaller size than the upper part. Furthermore, the baby cradle has a classic design, when compared with some previous designs. All the electrical components are placed inside an electric box beside the cradle wall. The electrical components are secured and do not affect the system and safety of the baby if circuit shortage occurs.

The cylinder on top of the cradle is the baby's musical toy that is placed on top of the baby's head to calm the baby and cause the baby to become drowsy. The baby cradle's base is also made up from meranti wood. However, it is slightly thicker than the rest of the cradle to ensure safety and in consideration of the babies' weight according to Malaysian statistics.

IV. DEVELOPING IOT-BBMS SYSTEM

A. MONITORING SYSTEM DESIGN

The cradle is designed to connect to the shaft of the geared motor. It swings when the switch is turned on by the user or when the sound sensor detected the baby's cry. The control circuit components are installed into the attached electrical box after the circuit testing phase. Figure 6 shows the circuit diagram of the virtual connection of electrical components using Fritzing software. The components are installed on the breadboard to ensure that the system works successfully before transferring the components onto the solder circuit panel. The shaft of the DC motor is connected to the cradle to allow swinging whenever the baby cry is detected or initiated by the user. The LED in Figure 6 replaces the lullaby toy given that the circuit design software does not have a library of lullaby toys. The camera is installed externally to monitor the baby's condition.

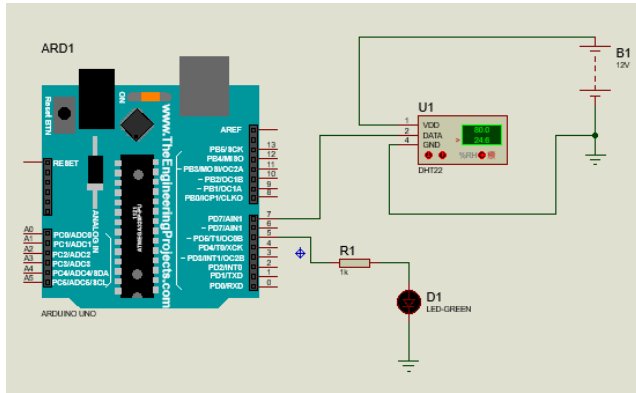

FIGURE 7. Proteus stimulation of the control circuit.

The control system of the smart baby cradle is equipped with 5 V USB power source, sound sensor module, temperature and humidity sensor, relays, ESP 8266 Wi-Fi module, and geared motor. Figure 7 shows the stimulation of DHT22 temperature and humidity sensors in the Proteus software. After the electronics stimulation in Proteus Simulation software, all the electrical and electronic components were assembled and connected to the micro-controller and programmed using Arduino software (IDE). However, the Proteus software was not fully utilized, because some of the component libraries were not found in the software, as well as on the Internet. Therefore, the sensors and components had to be tested experimentally using Arduino UNO. A LED is used to replace the actuators due to the lack of the library in the Proteus software.

B. IMPLEMENTATION OF IoT-BBMS

In the practical implementation of the designed system, the original 9 V DC battery source shown in Figure 6 was changed to AC to DC 12 V output converter, because the 9 V DC battery was unable to supply the current efficiently to the entire circuit. Hence, an AC to DC power supply was used. A 5 V 3 A USB module was used to convert the 12 V output to 5 V output for the activation of the mini fan. It was also used to supply electricity to the NodeMCU microcontroller. The USB module has a built-in step-down converter that can reduce an input of 6–24 V to the output of 5 V, with a maximum output current of 3 A at full load.

The connection of the NodeMCU is coded to connect to a certain Wi-Fi network with the given password written in the coding, because the Internet of UMP has certain restrictions, which would cause the connection of the system to fail. The process is then retested using the programmer mobile phone’s data hotspot. The connection was successful, and no time delay was encountered during the performance of the sending and fetching of data to and from the MQTT server.

The DHT22 temperature and humidity sensor was mounted on the side of the electrical box by drilling a hole to enable the sensor to fit in the hole, as shown in Figure 8 (a), to measure the ambient temperature. Thus, the DHT22 sensor can be exposed to the surrounding temperature and then measured

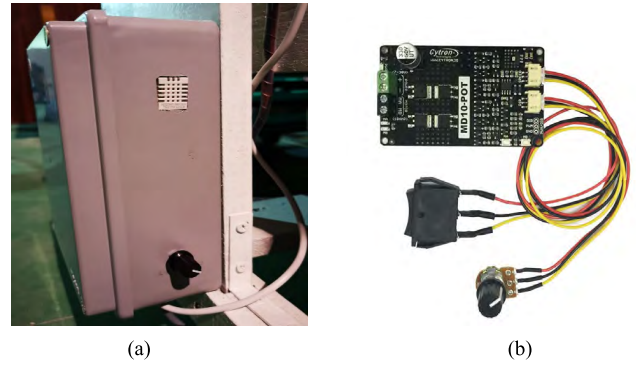

FIGURE 8. (a) Side view of the electrical box; (b) MD10-POT 10Amp DC motor driver.



FIGURE 9. Rotating mechanism of the baby cradle.

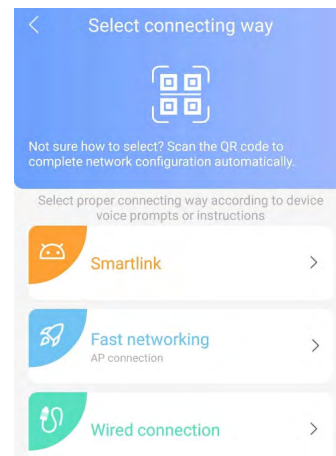

FIGURE 10. Methods of connecting the camera application.

for uploading to the MQTT server. A sound sensor is placed at the top of the baby’s cradle to enable sound detection. Figure 8(b) shows the MD10-POT 10 Amp DC motor driver used to vary the speed of the 12 V DC motor that swings the cradle. The motor driver supports the motor voltage that ranges from 7 V to 30 V and can withstand the maximum current up to 10 A continuous and 30 A peak (10 seconds). The speed, round per minute (RPM), of the connected DC motor can be varied by tuning the potentiometer and the rotating direction with a two-direction switch. The black knob under the DHT22 in Figure 8 (a) is the potentiometer of the DC motor driver that allows the user to manually adjust the speed of the baby cradle.

The rotating mechanism for swinging the cradle is displayed in Figure 9. A piece of aluminum sheet was cut into a round shape. The DC motor was then locked with a motor coupler attached to the piece of the round aluminum sheet. The edge of the aluminum sheet was punched into a hole by using a drill machine. A wood was cut into 30 cm long, 2 cm width, and 2 cm height. The wood was then screwed onto the edge of the aluminum sheet. This mechanism swings the baby cradle by raising the cradle to one side and to another side whenever the motor rotates. It causes the cradle to swing by elevating around 20 degrees on one side and dropping while the DC motor rotates to 360 degrees.

An Arduino UNO is used as the basic tester to try out the codes and the equipment to ensure that all the components, such as relay and sensors, are working effectively before compiling all the codes into the main controller board, which is the NodeMCU microcontroller. The code for each sensor works by running on its own in Arduino UNO without interfering with other sensors and then compiling the codes. The sequence of the code must be rearranged according to the design of the entire baby monitoring system, i.e., which sensor runs first and which next sensor follows once triggered. The obtained data from the implemented sensors (sound, temperature, and humidity) are updated to Adafruit MQTT IoT server and are used to trigger the connected actuators (swinging motor, musical toys, and mini fan).

The wireless camera can be connected in three steps, as shown in Figure 10. The first step is to connect to the available Wi-Fi network in the house. The user has to setup the configuration of the wireless camera during the initial setting. The second step is directly connecting to the wireless camera's built-in Wi-Fi, which is the AP connection. The benefit of the AP connection is that the setting configuration can be faster due to direct connection from the mobile phone to the camera. The third step is using the wired connection via Ethernet cable directly from the Internet modem to the wireless camera. For all three steps, the setup processes are the same.

The real-time camera is used for visual monitoring of the baby's situation as an add-on functionality for the developed smart cradle. The quality of the camera view can be viewed in high definition (HD). With a photoresistor and IR LEDs, the camera also records night vision of the house. The wireless camera head is rotatable with 355° pan and 120° tilt. The user can control it via the app, and a sweeping view of every inch of the entire house is achieved.

C. DESIGN ENHANCEMENT AND OPTIMIZATION

This phase is important to improve the system performance and detect any error. In this phase, the problem in the previous phases was identified and resolved. This step was repeated until a successful implementation was achieved. In the previous phase, a LED was used as the replacement to read output, such as using LED as the replacement during the trials for fan, motor, and buzzer while waiting for the arrival of the actual product. After compiling all the programming codes into the

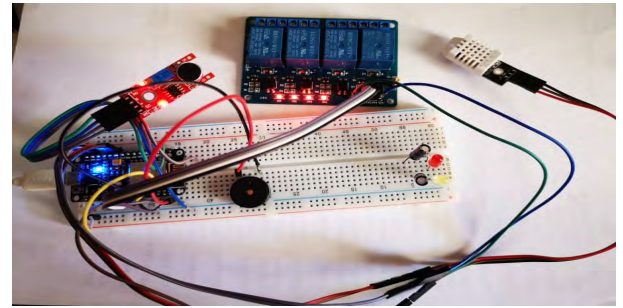

FIGURE 11. Connection of the sensors and actuators on the breadboard.

NodeMCU, the actuators, such as buzzer, relay module, and others, were used for the actual test on the breadboard.

Figure 11 shows the connection and the testing of the outcome of the system for better optimization. In the coding, the fan was set to turn on automatically whenever the measured temperature reached 28 °C or higher. The sound sensor was given a certain range of threshold values, because the value measured by the sound sensor had a slight fluctuation. Whenever the measured value exceeded the threshold value, the DC motor connected to the relay was turned on to swing the baby cradle.

After enhancement and optimization, some components were soldered on the Donut board. A pair of female headers was soldered on the donut board for the microcontroller, which can be removed whenever any replacement is required in the future. The sound sensor and the temperature and humidity sensor were placed outside the solder board to measure the surrounding readings. Each microcontroller pin was extended using the female headers. Each microcontroller's female header pin was soldered to each extended female pin on the donut board and tested with the digital multimeter to ensure the continuity and sufficiency of each pin. Figure 12 shows the pin solder connection on the top and bottom views.

D. SYSTEM ARCHITECTURE

Figure 14 presents the overall system architecture of the developed IoT-BBMS with its control box. NodeMCU is used as the micro-controller to receive and upload data to the server with the embedded Wi-Fi module. We used Adafruit.io as the MQTT IoT server for speed and ease of data uploading. The users can connect to the Internet either through Wi-Fi or mobile data connection by using their smart devices, such as PC, laptop, and smartphones. Through the internet, the users can wirelessly perform remote monitoring of the baby's conditions by obtaining the data from the sensors and actuators connected to the NodeMCU.

The system architecture consists of a baby cradle that automatically swings using a motor when the baby cries according to the sound sensor signal. In addition, a mini fan automatically opens to provide a cool temperature surrounding to the baby based on the temperature sensor. The parents can observe the normal data recorded in the MQTT server cloud, such as ambient temperature and remote switches, through

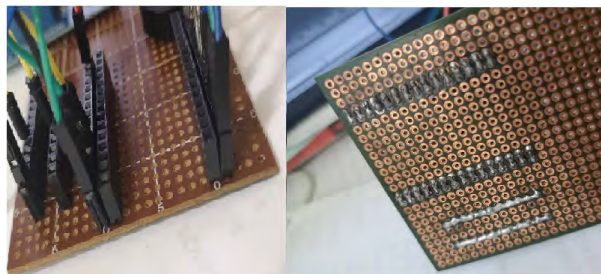

FIGURE 12. Pin solder connection.

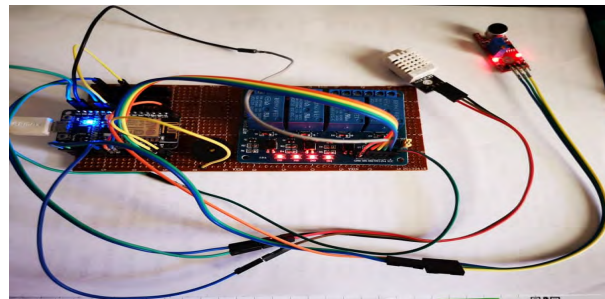

FIGURE 13. Actual connection on donut board.

the Internet using MQTT server, whereas the abnormal conditions are conveyed to the parents with triggering alarm to take appropriate actions. The parents can also monitor the baby’s condition through an external web camera and switch on the lullaby toy located on the baby’s cradle remotely via the MQTT server to entertain the baby.

NodeMCU, which is a low-cost thumb-sized microcontroller, is used as the central controlling unit. NodeMCU is an open-source software and development board that is embedded with a System-on-chip (SoC) named ESP8266.

It is a self-contained Wi-Fi networking solution offering as a bridge from existing microcontroller to Wi-Fi. It is also capable of running self-contained applications. It has a built-in USB connector that connects to the computer using a USB cable for upload coding. This is same as the other development boards available in the market, such as Arduino and Raspberry Pi.

A condenser MIC is used to detect the crying of the baby and to provide the signal to the microcontroller.

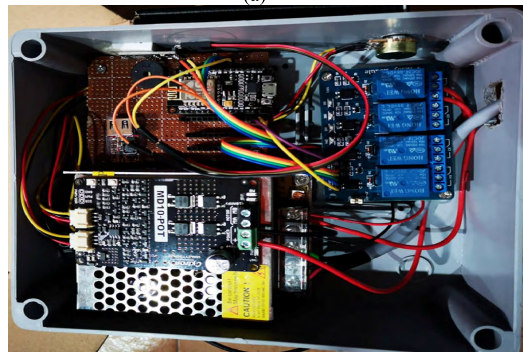
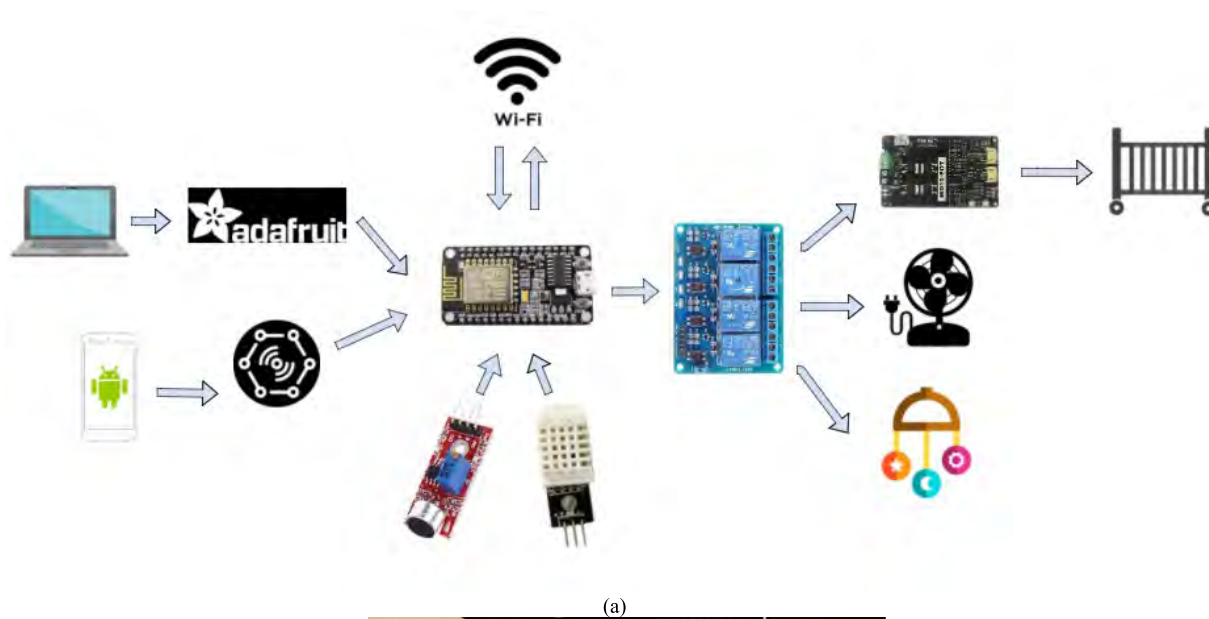

FIGURE 14. (a) IoT-BBMS architecture (b) Installation of all components in an electrical box.

Algorithm 1 Monitoring and Control Algorithm for IoT-BBMS

Require: If baby crying: swing baby's cradle and play musical toy
Ensure Real-time vision monitoring and good baby surrounding conditions (temperature, humidity)

- 1: **Define** Wi-Fi Access Point Username/PW
- 2: **Define** Adafruit_MQTT AIO_KEY & IFTTT Server
- 3: **Define** NodeMCU.GPOI for Relay board // For switching actuators (swing motor, fan, musical toy, and buzzer)
- 4: **Define** NodeMCU.GPOI for sensors // For getting sensors data (Temperature, humidity, and sound)
- 5: $T \leftarrow$ Temperature value // From DHT_22
- 6: $H \leftarrow$ Humidity value // From DHT_22
- 7: $S \leftarrow$ Sound value // From Sound Detection sensor
- 8: $S_{TH} \leftarrow$ Sound Threshold value
- 9: $TEM_{TH} \leftarrow$ Temperature Threshold value
- 10: $H_{TH} \leftarrow$ Humidity Threshold value
- 11: Initialize IoT-BBMS // Switching ON the system at $t = 0$
- 12: NodeMCU acquires the data (sound, temperature, humidity)
- 13: Wi-Fi-based Webcam provides vision monitoring of baby
- 14: **for** each round **do**
- 15: Get S, T, and H
- 16: **if** $S > S_{TH}$ **then**
- 17: Switch ON Cradle's Swing Motor
- 18: Switch ON Musical toy
- 19: Notify parents via IFTTT "Baby crying is detected!"
- 20: **else if**
- 21: $T \geq TEM_{TH} || H \geq H_{TH}$ **then**
- 22: Switch ON FAN
- 23: Notify parents via IFTTT "Temp./Hum. are High!"
- 24: **else**
- 25: Switch OFF Cradle's Swing Motor
- 26: Switch OFF Musical toy
- 27: Switch OFF FAN
- 28: **end for**
- 29: Upload data to **Adafruit MQTT Server** over **Wi-Fi**
- 30: Update **status of sensors/actuators** in **Adafruit MQTT Server**
- 31: Synchronize data to **MQTT Dash App.** using Smartphone
- 32: Control actuators remotely via **MQTT Dash App.**
- 33: Update camera vision to **YYP2P App.** over **Wi-Fi**

A temperature and humidity sensor, DHT22, is used in the proposed system to measure the room temperature. This system consisted of a four-channel relay module, which is controlled by the microcontroller. When the condenser MIC detected sound from the baby, a signal is sent to NodeMCU. NodeMCU switches the relay that is connected to a DC motor, which in turn is connected to the cradle for swinging purposes. The temperature and humidity sensor measures the room temperature, records the readings in the NodeMCU, and uploads the readings to the MQTT server at the same time. If the room's temperature exceeded a certain temperature, then the NodeMCU switches on the relay connected to the mini fan to lower the temperature and cool the baby, as well as prevent overheating. An external Wi-Fi camera is used in this system to allow the parent to monitor the real-time baby condition. In the developed system, Algorithm 1 is developed

and implemented in NodeMCU controller to perform the required monitoring and control tasks.

Adafruit.io is used as the MQTT server for this system. The measured readings including the condition of the relay switches, whether the switches are on or off, are uploaded to the server through the NodeMCU microcontroller. When the users control the system using their laptops or smartphones outdoor, the command is sent to the NodeMCU through the MQTT server. NodeMCU then sends a signal to switch on/off the respective relay switches based on the user's preference from the Adafruit.io Server Interface by using their fingertips.

E. SYSTEM OPERATION MECHANISM

Figure 15 shows the flowchart of the general work flow of the baby monitoring system. The NodeMCU had to be connected to the pre-set Wi-Fi network when power of the

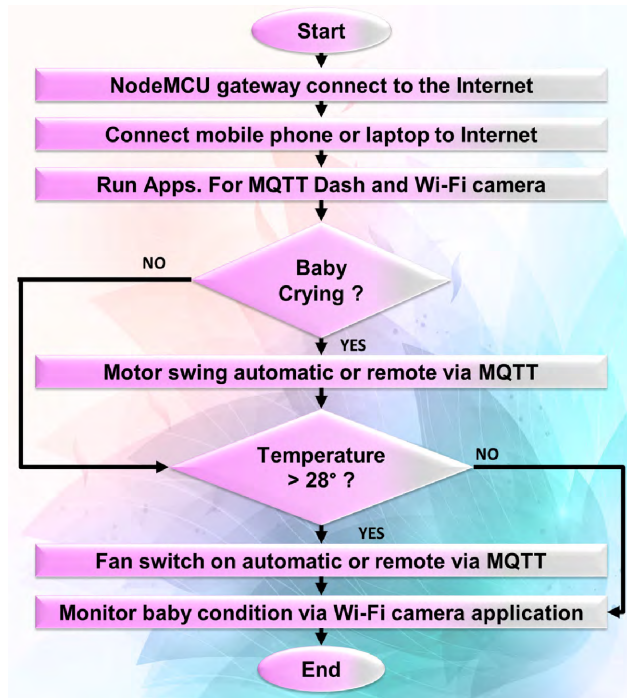

FIGURE 15. Flowchart of the system.

microcontroller is turned on. The buzzer rings for 1 second to indicate that the microcontroller is connected to the Wi-Fi network. The user must access the Internet via their mobile phone/laptop to monitor and control the smart cradle. Then, the user has to run applications for MQTT Dash or wireless camera. The system starts working by checking the detection of sound through the sound sensor. The measured reading might fluctuate due to wind or noise. Hence, a range of threshold values was set for the fluctuation detection. When the baby's cry is detected, the measured value exceeds the threshold value, and the cradle is swung by turning on the Relay 1 connected to the DC geared motor either automatically or manually.

The user is notified through the IFTTT mobile application's notification once the sound is detected. Then, the room temperature and humidity is measured. If the room's temperature exceeded 28 °C, then the mini fan is turned on automatically. In between the process, the measured reading is uploaded to the MQTT server as well as the condition of the relays every time the relays are turned ON or OFF. The user can also view the baby's real-time condition through the wireless camera application. In this baby monitoring system, the user can manually control the system through the Internet.

V. RESULTS AND VALIDATION

In this section, the results, discussion, and validation of IoT-BBMS are presented in detail. Figure 16 shows the final prototype of the developed smart cradle. Several manufacturing steps were carried out prior to the implementation of the control system for the smart cradle.



FIGURE 16. Smart cradle final prototype.

The data measured by the utilized sensors, namely, sound sensor, temperature, and humidity are updated to the Internet and can be accessed via the Adafruit MQTT server and MQTT Dash mobile applications. A mobile MQTT application, which is compatible with the Android operating system mobile phone, can be downloaded from the Play Store. The application's name is "MQTT Dash," which can be synchronized with the Adafruit MQTT server. After some optimization and testing, we select this application for developing our dashboard due to its simplicity and user friendliness in terms of the view and usage. During the synchronization process, the targeted MQTT server address is required, followed by the host port, the username, and the specified authentication token provided by the server. Figure 10 shows the requirements of the synchronization process for the mobile apps to share the same data received from the sensors. The password represents the authentication token (AIO key) generated by the MQTT server.

As shown in Figures 18 and 19, the MQTT server and MQTT Dash apps are synchronized and displayed the same readings uploaded by the NodeMCU microcontroller of the baby monitoring system. The smart cradle can swing automatically whenever sound is detected by the sound sensor. A notification, shown in Figure 20, is sent to the user through IFTTT mobile application to notify the user that crying is detected on the baby monitoring system. The user can also remotely control the cradle to swing manually by toggling the switch in the MQTT server or mobile apps. The mini fan is designed to turn on automatically whenever the room's temperature, measured by the temperature sensor, is higher than 28 °C. The user can also remotely switch the mini fan ON and OFF through the MQTT server and mobile application. A musical toy, which can be controlled by the user, is installed to entertain the baby. For visual monitoring of the baby's situation, Figure 21 shows the camera view taken from a mobile application. Real-time visual monitoring is achieved by using an external wireless camera.

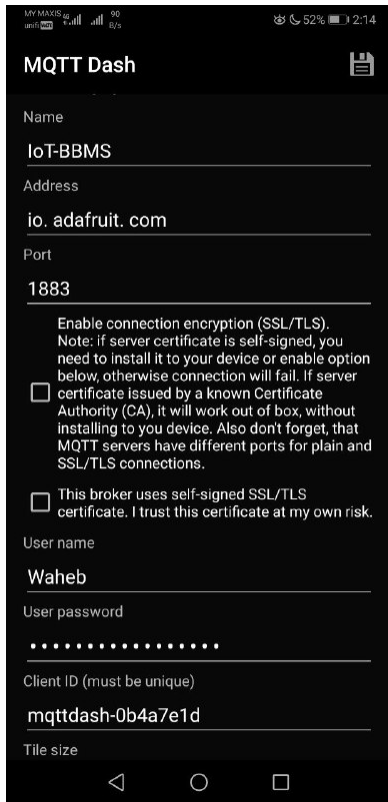

FIGURE 17. Process of synchronizing apps with MQTT server.

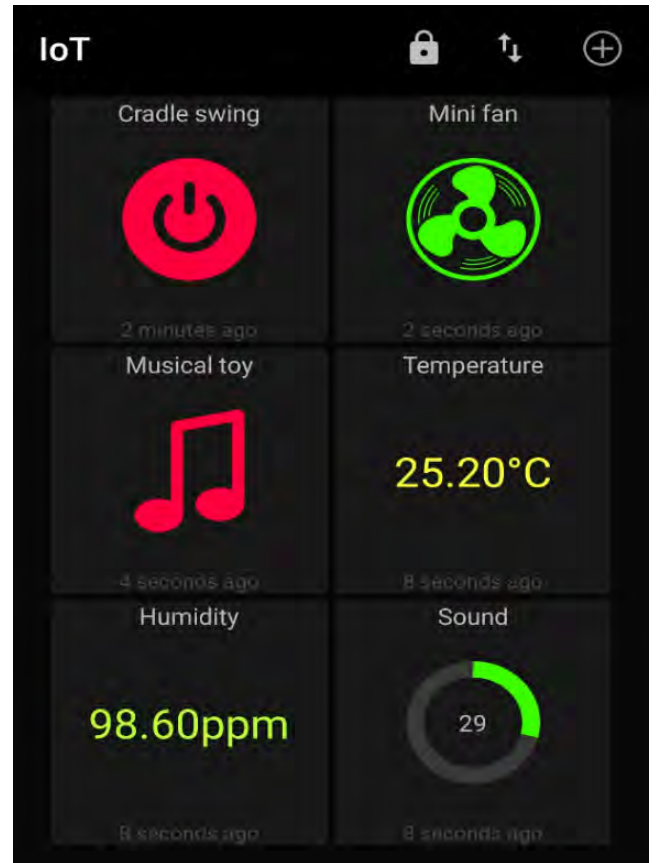

FIGURE 19. MQTT dash mobile application interface.

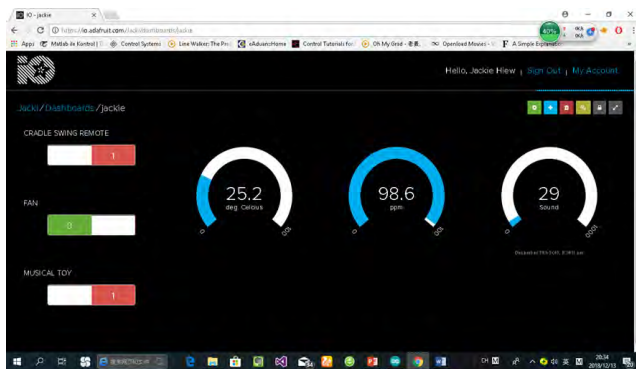

FIGURE 18. User interface on the Adafruit.io MQTT server webpage.

Figure 22 illustrates the monitoring and control process of the smart cradle by data retrieval from the exploited sensors and actuators. The GUI also shows the ON/OFF toggle switches that provide a command to the relays by the user to control the DC motor, the mini fan, and the musical toy. In addition, the color of the relay status (GREEN/RED) is updated when the relays are switched ON/OFF due to the triggering of the conditions by the sensors or manually controlled by the user. The relay switch icons turn green whenever the relays are turned on, whereas the icon turns red to indicate that the relays are off. Three display blocks are found with some values. The data from the sensors are uploaded to those blocks. The sensors measure the readings uploaded into the server

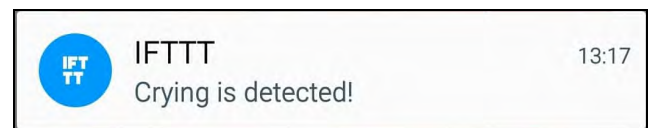

FIGURE 20. Notification to the user through IFTTT application.



FIGURE 21. Wireless camera view.

by the NodeMCU through the Wi-Fi network. The user can select from the developed GUI whether to monitor the measured values from the system or the status of the switches/relays at once in one glance.

The change in sensor reading and their effects on actuator status are depicted in the same dashboard, thereby showing

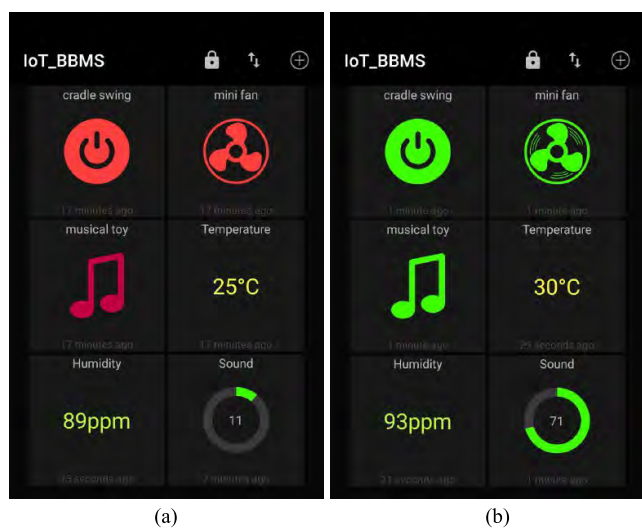

FIGURE 22. Sensor and actuator status: (a) OFF State; (b) ON State.

the MQTT GUI via mobile phone for two different cases. In the first case shown in Figure 22(a), the sound level is low as well as the obtained readings from the DHT22 sensor (temperature and humidity). Thus, all actuators (motor, fan, and musical toys) are in the OFF state. Figure 22(b) indicates the impact of increasing the level of the baby's sound on the DC motor, which swings the cradle and switches ON the musical toy. Similarly, the increase in the ambient temperature switches ON the mini fan to provide a suitable environment for the convenience of the baby.

The prototype was tested with the help of a 10 kg ballast to simulate a baby. Most babies in Malaysia have an average weight of 10 kg. Then, we tested whether the system can run smoothly as we planned. Moreover, the prototype's functionality was tested with the aid of a mobile phone by opening a baby crying sound surfed from the Internet. A mobile phone was brought near the sound sensor as the stimulation of an actual baby crying situation. The sound detection has some time delay probably due to the loop process in the programming codes. The cradle started the swinging action when the value of the detected sound exceeded the set threshold value. The user was notified when the cradle started to swing, thereby indicating that the baby was crying at that moment.



The prototype was also tested with the time delay of the upload data from the system to the MQTT server. The process of uploading and fetching the data to and from the server had some time delay of approximately 1 second. Several testing processes were performed, and no time delay was observed in some instances. However, some results of the testing showed a slight time delay. After several testing and fabrication processes, the possibility of the occurrence of time delay depended on the strength of the connected network. No time delay was detected when the Wi-Fi connection was sufficiently strong.

VI. CONCLUSION

A smart cradle with a baby monitoring system over IoT has been designed and fabricated to monitor a baby's vital parameters, such as crying condition, humidity, and ambient temperature. NodeMCU was used as the main controller board in the project's circuit design, because it had a built-in Wi-Fi module, which enabled the implementation of IoT concept in the developed system. The demand of IoT was achieved by using the NodeMCU due to its simplicity and open-source nature. Red meranti wood was used as the material to build the baby's cradle, because of its general use in woodworks and due to its workability. Improvements were made during the enhancement phases to ensure that the research outcomes achieved the objectives. The finished prototype was tested by using a mobile phone with a baby crying ringtone, which was placed in the cradle. When the mobile phone rang for a few seconds, the cradle started swinging because of the system's assumption that the baby was crying due to the detected sound. A notification was sent to the mobile phone of the user to signal that the baby is crying. The temperature and humidity of the surroundings were determined, and the mini fan was turned on if the measured temperature was above 28 °C. With the aid of NodeMCU, the parents can control the baby cradle and the mini fan using mobile apps or an Internet-connected computer. Real-time vision monitoring was achieved with the help of the wireless camera. The user can monitor the baby through the camera mobile application and talk to the baby through the built-in microphone on the wireless camera. The total cost of the developed system is greatly reduced to approximately RM 700 per unit, which is suitable for mass production after finalizing the prototype.

Our system's GUI needs to be improved to overcome limitations of both Adafruit.io MQTT server webpage and MQTT Dash mobile application. We will develop our own web-based and Android-based dashboards for laptops, PCs and smartphones, to add more monitoring and controlling functionalities based on our system requirements. Another limitation of the developed system is the wireless camera used, which is can only be connected to a local network. Parents can only view the section where the camera is positioned when they are connected to the same network as that of the wireless camera. TransFlash card can be used for the camera to record the baby's activities, but it is not considered real-time monitoring. Therefore, for future works, the wireless camera can be changed into an IP camera to enable IP hosting viewing in the network. The parents can type the set IP address for the IP camera in the network browser to monitor the baby's conditions in real time. In addition, other future works can be conducted to further improve this system. A lighter and safer material, such as soft plastic, can be used to replace the wood materials to ensure the safety of the baby and reduce the weight of the baby cradle. A sound sensor with better quality can be implemented for better noise capturing; along with some coding changes, the level of the baby's crying can

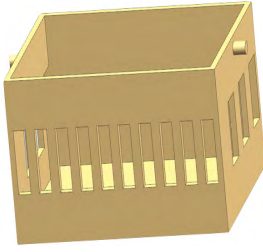
TABLE 1. Design of baby cradle using NX10 software.

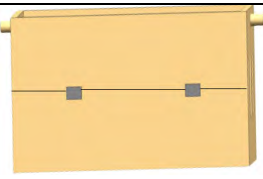
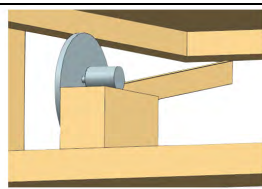
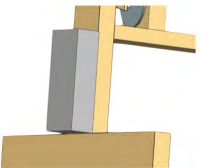
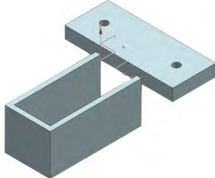
Part Design	Features	Part Design	Features
	<ul style="list-style-type: none"> • Main place for the baby. • Size of this part is (900x600x500) mm. • The small cylindrical section at the side of the cradle connect to the legs for support. • Three sides of this baby cradle contain several rectangular holes. 		<ul style="list-style-type: none"> • Support system for the baby cradle. • Height of these legs is 800 mm. • The base size is (900x127x25) mm. • Wood at the center is used to support the legs. • The cylindrical knob are attached via the semi-holes in the legs. • Four plastic caster wheels are placed on each side at the base.
	<ul style="list-style-type: none"> • Back side of the cradle is connected by two hinges. • It can be half open to ease the user. • This cradle can be detached from its legs. 		<ul style="list-style-type: none"> • The motor is placed above the stack of woods. • Motor and aluminum were connected using a coupler. • Diameter for the round aluminum is 40 cm • A single piece of wood is connector between the circle aluminum and the cradle by using a hook.
	<ul style="list-style-type: none"> • Rectangular box for electronic components. • Located far from the baby inside the cradle • 		<ul style="list-style-type: none"> • Sensor's holder, where the sound sensor at the cradle is placed • This sensor detects a baby's cry. Prevents contact between the sound sensor and the baby or parent

be distinguished, i.e., whether it is low, medium, or high dB crying. The motor attached to enable the swing process can be coded to vary its speed according to the measured dB(s). The 12 V DC geared motor can be changed to 12 V stepper motor given that the rotation direction of the stepper motor can be changed by coding. Furthermore, additional wearable sensors to monitor various baby conditions can be installed. Regarding the utilized GUI that is based on

APPENDIX

See Table 1.

REFERENCES

[1] R. S. C. Horne, "Sudden infant death syndrome: Current perspectives," *Int. Med. J.*, vol. 49, no. 4, pp. 433–438, 2019.

[2] B. J. Taylor, J. Garstang, A. Engelberts, T. Obonai, A. Cote, J. Freemantle, M. Vennemann, M. Healey, P. Sidebotham, E. A. Mitchell, and R. Y. Moon, "International comparison of sudden unexpected death in infancy rates using a newly proposed set of cause-of-death codes," *Arch. Disease Childhood*, vol. 100, no. 11, pp. 1018–1023, 2015.

[3] A. B. E. Lambert, S. E. Parks, and C. K. Shapiro-Mendoza, "National and state trends in sudden unexpected infant death: 1990–2015," *Pediatrics*, vol. 141, no. 3, 2018, Art. no. e20173519.

[4] I. Jhun, D. A. Mata, F. Nordio, M. Lee, J. Schwartz, and A. Zanobetti, "Ambient temperature and sudden infant death syndrome in the United States," *Epidemiology*, vol. 28, no. 5, pp. 728–734, 2017.

[5] W. A. Jabbar, M. H. Alsibai, N. S. S. Amran, and S. K. Mahayadin, "Design and implementation of IoT-based automation system for smart home," in *Proc. IEEE Int. Symp. Netw., Comput. Commun. (ISNCC)*, Jun. 2018, pp. 1–6.

[6] Y. Lu and J. Cecil, "An Internet of Things (IoT)-based collaborative framework for advanced manufacturing," *Int. J. Adv. Manuf. Technol.*, vol. 84, nos. 5–8, pp. 1141–1152, May 2016.

[7] W. A. Jabbar, W. K. Saad, and M. Ismail, "MEQSA-OLSRv2: A multicriteria-based hybrid multipath protocol for energy-efficient and QoS-aware data routing in MANET-WSN convergence scenarios of IoT," *IEEE Access*, vol. 6, pp. 76546–76572, 2018.

[8] R. Romansky, "A survey of digital world opportunities and challenges for user's privacy," *Int. J. Inf. Technol. Secur.*, vol. 9, no. 4, pp. 97–112, 2017.

[9] M. Sharma, G. Singh, and R. Singh, "An advanced conceptual diagnostic healthcare framework for diabetes and cardiovascular disorders," 2019, *arXiv:1901.10530*. [Online]. Available: <https://arxiv.org/abs/1901.10530>

[10] S. B. B. Priyadarshini, A. BhusanBagjadab, and B. K. Mishra, "The role of IoT and big data in modern technological arena: A comprehensive study," in *Internet of Things and Big Data Analytics for Smart Generation*. Cham, Switzerland: Springer, 2019, pp. 13–25.

[11] R. Krishnamurthy and J. Cecil, "A next-generation IoT-based collaborative framework for electronics assembly," *Int. J. Adv. Manuf. Technol.*, vol. 96, nos. 1–4, pp. 39–52, 2018.

[12] M. P. Joshi and D. C. Mehetre, "IoT based smart cradle system with an Android app for baby monitoring," in *Proc. Int. Conf. Comput., Commun., Control Autom. (ICCUBE)*, 2017, pp. 1–4.

[13] K. Lohekar, S. Deshmukh, S. Ambekar, N. Gole, and L. Vina, "Smart baby cradle," *Int. J. Res. Eng., Sci. Manage.*, vol. 2, no. 3, Mar. 2019. [Online]. Available: https://www.ijresm.com/Vol2_2019/Vol2_Iss3_March19/IJRESM_V2_I3_155.pdf

[14] M. S. Rachana, S. M. Nadig, R. Naveen, N. K. Pooja, and M. T. G. Krishna, "S-MOM: Smart mom on the move," in *Proc. 2nd Int. Conf. Trends Electron. Informat. (ICOEI)*, 2018, pp. 1341–1344.

[15] M. Levy, D. Bhiwapurkar, G. Viswanathan, S. Kavyashree, and P. K. Yadav, "Smart cradle for baby using FN-M16P module," *Perspect. Commun., Embedded-Syst. Signal-Process.*, vol. 2, no. 10, pp. 252–254, 2019.

[16] S. Brangui, M. El Kihal, and Y. Salih-Alj, "An enhanced noise cancelling system for a comprehensive monitoring and control of baby environments," in *Proc. Int. Conf. Elect. Inf. Technol. (ICEIT)*, 2015, pp. 404–409.

[17] M. Goyal and D. Kumar, "Automatic E-baby cradle swing based on baby cry," *Int. J. Comput. Appl.*, vol. 975, p. 8887, Jan. 2013.

[18] R. Palaskar, S. Pandey, A. Telang, A. Wagh, and R. M. Kagalkar, "An automatic monitoring and swing the baby cradle for infant care," *Int. J. Adv. Res. Comput. Commun. Eng.*, vol. 4, no. 12, pp. 187–189, 2015.

- [19] C.-T. Chao, C.-W. Wang, J.-S. Chiou, and C.-J. Wang, "An Arduino-based resonant cradle design with infant cries recognition," *Sensors*, vol. 15, no. 8, pp. 18934–18949, 2015.
- [20] A. F. Symon, N. Hassan, H. Rashid, I. U. Ahmed, and S. M. T. Reza, "Design and development of a smart baby monitoring system based on Raspberry Pi and Pi camera," in *Proc. 4th Int. Conf. Adv. Elect. Eng. (ICAEE)*, 2017, pp. 117–122.
- [21] A. Kaur and A. Jasuja, "Health monitoring based on IoT using Raspberry Pi," in *Proc. Int. Conf. Comput., Commun. Autom. (ICCCA)*, May 2017, pp. 1335–1340.
- [22] S. P. Patil and M. R. Mhetre, "Intelligent baby monitoring system," *ITSI Trans. Elect. Electron. Eng.*, vol. 2, no. 1, pp. 11–16, 2014.
- [23] E. Saadatian, S. P. Iyer, C. Lihui, O. N. N. Fernando, N. Hideaki, A. D. Cheok, A. P. Madurapperuma, G. Ponnampalam, and Z. Amin, "Low cost infant monitoring and communication system," in *Proc. IEEE Colloq. Humanities, Sci. Eng.*, Dec. 2011, pp. 503–508.
- [24] D. N. F. M. Ishak, M. M. A. Jamil, and R. Ambar, "Arduino based infant monitoring system," in *Proc. IOP Conf. Ser., Mater. Sci. Eng.*, 2017, vol. 226, no. 1, Art. no. 012095.
- [25] J.-R. C. Chien, "Design of a home care instrument based on embedded system," in *Proc. IEEE Int. Conf. Ind. Technol.*, Apr. 2008, pp. 1–6.



SAIDATUL N. I. S. HAMID received the B.Tech. degree in manufacturing from University Malaysia Pahang, Gambang, Malaysia, in 2019. She is currently a Research Assistant in manufacturing engineering with the Faculty of Engineering Technology, Universiti Malaysia Pahang. Her research interests include robotics and mechatronics.



AKRAM A. ALMOHAMMEDI received the B.Sc. degree in electronics engineering from Infrastructure University Kuala Lumpur (IUKL), Malaysia, in 2012, and the M.Sc. degree in electrical and electronics engineering (majoring in computer and communication system) from Universiti Kebangsaan Malaysia (UKM), Malaysia, in 2014. He is currently pursuing the Ph.D. degree with Universiti Putra Malaysia (UPM), Malaysia. His research interests include vehicular ad hoc networks, multi-channel MAC, and wireless sensor networks.



WAHEB A. JABBAR received the B.Sc. degree in electrical engineering from the University of Basrah, Iraq, in 2001, and the M.Eng. degree in communication and computer and the Ph.D. degree in electrical, electronics, and system engineering from Universiti Kebangsaan Malaysia (UKM), Bangi, Selangor, Malaysia, in 2011 and 2015, respectively. He is currently a Senior Lecturer with the Faculty of Engineering Technology, Universiti Malaysia Pahang (UMP), Gambang, Pahang, Malaysia. His research interests include routing protocols in ad hoc networks, mobile communications, wireless networking, the Internet of Things applications, and smart city.



ROSHAHLIZA M. RAMLI received the B.E. degree in information system and the M.E. degree in electrical engineering and computer science from the Polytechnic University of Japan, in 2008 and 2010, respectively, and the Ph.D. degree in electrical, electronic, and system engineering (signal processing) from Universiti Kebangsaan Malaysia, in 2015. She is currently a Senior Lecturer with the Faculty of Engineering Technology, Universiti Malaysia Pahang. Her research interests include research involving telecommunication technologies, digital/adaptive filtering, speech/audio processing, and algorithm development and their applications.



HIEW KUAT SHANG received the B.Tech. degree in electrical engineering from University Malaysia Pahang, Gambang, Malaysia, in 2019. He is currently a Research Assistant with the Faculty of Engineering Technology (Electrical), Universiti Malaysia Pahang. His research interests include the Internet of Things and automation systems.



MOHAMMED A. H. ALI received the B.Eng. degree in mechanical engineering from Tishreen University, Lattakia, Syria, in 2003, the M.Sc. degree in mechatronics from the University of Siegen, Siegen, Germany, in 2010, and the Ph.D. degree in robotics from Universiti Teknologi Malaysia, Johor Bahru, Malaysia, in 2014. He is currently a Senior Lecturer with Universiti Malaysia Pahang, Kuantan, Malaysia. His research interests include mobile robot navigation, robot path planning and control, mechatronics, and image processing.

...