

Received January 17, 2019, accepted February 4, 2019, date of publication February 19, 2019, date of current version March 7, 2019.

Digital Object Identifier 10.1109/ACCESS.2019.2900233

# Hybrid Fuzzy Logic Scheme for Efficient Channel Utilization in Cognitive Radio Networks

AMJAD ALI<sup>1,2</sup>, LARAIB ABBAS<sup>3</sup>, MUHAMMAD SHAFIQ<sup>4</sup>,  
ALI KASHIF BASHIR<sup>5</sup>, (Senior Member, IEEE),  
MUHAMMAD KHALIL AFZAL<sup>6</sup>, (Senior Member, IEEE), HANNAN BIN LIAQAT<sup>3</sup>,  
MUHAMMAD HAMEED SIDDIQI<sup>7</sup>, AND KYUNG SUP KWAK<sup>1</sup>, (Member, IEEE)

<sup>1</sup>Department of Information and Communication Engineering, Inha University, Incheon 402-751, South Korea

<sup>2</sup>Department of Computer Science, COMSATS University Islamabad, Lahore Campus, Lahore 54000, Pakistan

<sup>3</sup>Department of Information Technology, University of Gujrat, Gujrat 70500, Pakistan

<sup>4</sup>Department of Information and Communication Engineering, Yeungnam University, Gyeongsan 38541, South Korea

<sup>5</sup>Department of Computing, Mathematics, and Digital Technology, Manchester Metropolitan University, Manchester M1 5GE, U.K.

<sup>6</sup>Department of Computer Science, COMSATS University Islamabad, Wah Campus, Wah Cantonment 47040, Pakistan

<sup>7</sup>Department of Computer and Information Sciences, Jouf University, Sakakah 72441, Saudi Arabia

Corresponding author: Kyung Sup Kwak (kskwak@inha.ac.kr)

This work was supported by the Ministry of Science and ICT, South Korea, through the Grand Information Technology Research Center Support Program, supervised by the Institute for Information and Communications Technology Promotion, under Grant IITP-2018-2015-0-00742.

**ABSTRACT** The proliferation of mobile devices and the heterogeneous environment of wireless communications have increased the need for additional spectrum for data transmission. It is not possible to altogether allocate a new band to all networks, which is why fully efficient use of the already available spectrum is the demand of the day. Cognitive radio (CR) technology is a promising solution for efficient spectrum utilization, where CR devices, or secondary users (SUs), can opportunistically exploit white spaces available in the licensed channels. SUs have to immediately vacate the licensed channel and switch to another available channel when they detect the arrival of the incumbent primary user. However, performance for the SU severely degrades if successive channel switching happens. Moreover, taking the channel-switching decisions based on crisp logic is not a suitable approach in the brain-empowered CR networks (CRNs) where sensing information is not only imprecise and inaccurate but also involves a major uncertainty factor. In this paper, we propose a fuzzy logic-based decision support system (FLB-DSS) that jointly deals with channel selection and channel switching to enhance the overall throughput of CRNs. The proposed scheme reduces the SU channel switching rate and makes channel selection more adaptable. The performance of the proposed scheme is evaluated using a Matlab simulator, and a comprehensive comparison study with a baseline scheme is presented. The simulation results are promising in terms of the throughput and the number of handoffs and making our proposed FLB-DSS a good candidate mechanism for SUs while making judicious decisions in the CR environment.

**INDEX TERMS** Cognitive radio network, fuzzy logic, resource allocation, channel selection, handoff rate.

## I. INTRODUCTION

In recent years, the widespread growth of wireless and mobile devices has turned the focus of the research community towards solving spectrum scarcity. The demand for mobile devices (laptops, cell phones, tablets, etc.) grows by around 30-40% every year, which has eventually increased the demand for available spectrum [1]. This situation has

dragged the research community into working on efficient utilization of spectrum bands with exploitation of radio band spaces that are otherwise not fully utilized. To address this challenge, cognitive radio networks (CRNs) emerged as a potential way out. Cognitive radio (CR) is a promising wireless technology introduced by Mitola [2]. The CRN architecture consists of CR-enabled users known as secondary users (SUs), which exploit the licensed channel of primary users (PUs) opportunistically, as shown in Figure 1. PUs are the

The associate editor coordinating the review of this manuscript and approving it for publication was Tariq Umer.

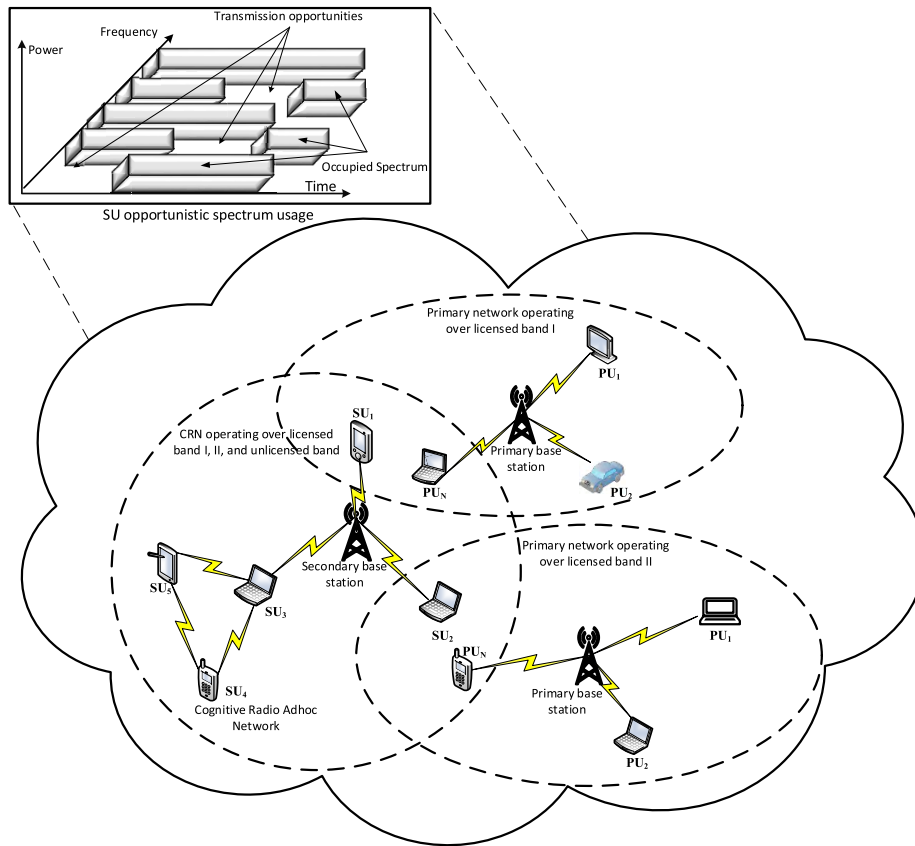

FIGURE 1. PU and SU co-existence environment.

privileged users; therefore, they have exclusive rights to use the licensed bands any time without any harmful interference from SUs. However, SUs can coexist with PUs if the aggregate interference with the PUs created by SUs is maintained below an agreed threshold.

The US Federal Communications Commission (FCC) proposed usage of an interference metric so that current spectrum access rights could be enforced, and so new opportunities for dynamic spectrum utilization could be created. The Spectrum Policy Task Force (SPTF) working under the FCC proposed the interference metric, i.e. the interference temperature (IT), which actually measures the radio frequency power at the receiver, generated by the transmitter and other noise sources. CRN is a brain-empowered communications paradigm, in which the SUs themselves intelligently adapt particular transmission or reception parameters by sensing the environment [3]. In CRNs, the term CR shows that this type of radios has some artificial intelligence-based capabilities to perform overall tasks such as spectrum mobility, spectrum sensing, spectrum management, spectrum sharing, and so on. In spectrum sensing, the SU senses the spectrum to detect white spaces, and then opportunistically utilizes those white spaces. However, when the aggregate IT goes beyond the acceptable threshold, the SU must immediately vacate the licensed channel and look for some other channel.

The way SUs make the decision to hand off, or switch, from one channel to another channel is challenging, owing to the fact that the sensed information in CRNs is imprecise, incomplete, and vague [4]. Moreover, the channel switching decision has a very significant impact on the throughput of the CRNs. If successive channel switching decisions have to be taken more often, then useful time is wasted just in channel switchings, and the overall performance of the system reduced significantly. Furthermore, continuous channel switchings (i.e., handoffs) may also cause harmful interference for the PU. Therefore, taking the channel switching decisions based on the crisp (binary) logic in brain-empowered networks where available information is not precise and incomplete is not recommended. Moreover, channel switching decisions cannot be taken independently, because they are highly dependent and influenced by channel selection decisions. Thus, channel switching and channel selection should be dealt with together to enhance the throughput of the CRNs. Moreover, in CRNs, channel selection decisions must incorporate the impact of the PUs as well as the needs of the SUs. The elementary idea of CR technology is the ability to properly sense the spectrum and to increase the effectiveness of spectrum utilization, which may be based on the following three techniques to the primary, or licensed, users without interfering with their transmissions [5]:

- **Interweave:** In this approach, an interference avoidance strategy is followed by interweaving the CRs [6]. The SUs are allowed to use the spectrum band only when PUs are inactive. This approach is called opportunistic, where the SU has to take advantage of unused spectrum, and implements the basic purpose of CR to exploit the available spectrum holes unused by the primary licensee. The only issue in the interweave approach is to keep sensing the channels and to predict the activity of the PU in order to detect the spectrum holes.
- **Underlay:** This is a more conservative choice to behave in an underlying approach [7]. Instead of observing the PU activity and utilizing a channel only when it is free, the approach comprises transmitting data at very low power to make sure that the interference with the PU does not increase above a specified threshold. This technique has different requirements for the SU transmitter, compared to other approaches.
- **Overlay:** The SU behaves in a cooperative manner by devoting a reasonable part of its transmission power to increasing the PU signal quality, and in response, it can easily facilitate its detection of the PU. In exchange, the PU may allow the SU a small increase in IT, compared to the underlay approach [8]. By contributing to the improvement of PU detection, there could be the possibility of a higher acceptance of this approach by the PUs. That is why the overlay approach could play an evolutionary role in efficient spectrum utilization, but a greater degree of integration between the PU and the SU is required. However, this approach has not yet been fully implemented.

Spectrum utilization schemes can be more effective in CRNs if they keep their channel selection and handoff decision quick. However, the coexistence of PUs and SUs is characterized as having a highly uncertain deriving factor under different constraints. The parameters and values taken by SUs to detect the presence of the PU or monitor the IT level present a great possibility for impreciseness and incorrectness. Moreover, fading, path loss, and noise add more uncertainty in wireless environment. Furthermore, different decision input variables (e.g., quality of service (QoS) indicators, signal-to-noise ratios, power levels, etc.) are not directly comparable, because they are heterogeneous. Thus, due to the incompleteness of available information to the SU and their qualitative reasoning can make channel selection and handoff decision challenging. Therefore, in this paper, we propose a fuzzy logic-based decision support system (FLB-DSS) to deal with such incompleteness, heterogeneity, and uncertainty that occur in CRNs. For improved performance and better channel utilization we adopt a hybrid approach (utilizing both underlay and interweave techniques), that permits SUs to transmit in parallel with the PUs by keeping transmission power under a specific threshold. We adopt interweave approach when the PU is not using a spectrum band. Thus, the SUs can transmit with full power to increase the decoding probabilities. However, in case of PU presence,

the SU will not vacate the license channel immediately but keep transmitting its data with low power to avoid the harmful interference with the PU. Furthermore, our proposed scheme is based on two fuzzy logic controllers to deal with handoff and channel selection decisions jointly. These two controllers operates on five most critical and significant performance parameters.

The rest of this paper is organized as follows. Section II describes the related work. Section III presents the system model. Section IV discusses fuzzy logic, our selected parameters, and describes the workings of the proposed FLB-DSS. Section V includes a performance analysis and the simulation results. Finally, the last section concludes the paper.

## II. RELATED WORK

In this section, we briefly discuss the state-of-the-art on fuzzy logic-based channel selection and utilization in CRNs. Various signal processing schemes for PU detection was presented in [9]. However, there is great room for improvement in avoiding sensing errors and uncertain results, and for better utilization of spectrum. Chatzikokolakis *et al.* [10] proposed a fuzzy logic-based spectrum sharing scheme, in which mobile network operators share spectrum availability information with other users interested to buy the license spectrum for their communications. The proposed scheme helps the operators to select the most suitable licensed channel that fulfilled their transmissions requirements. Suitable channel is selected based on the licensed shared access (LSA) spectrum efficiency, interference, load trend, user mobility, and co-primary spectrum efficiency parameters. In order to make better and more efficient channel handoff decisions, a fuzzy logic-based scheme was proposed in [11]. This scheme uses the interference, bit error, and signal strength as decision parameters. Moreover, a trained neural network is used to measure the channel gain on the basis of fuzzy patterns.

In [12], another scheme was proposed for channel selection by SUs in wireless regional area networks (WRANs) under the IEEE 802.22 standard. Therein, a backup channel and candidate channel list is created according to the previous transmission behavior of the PUs. Using a fuzzy logic controller, channel ranking is calculated to prioritize and categorize the channels as operating, backup, candidate, protected, occupied, and unclassified in order to select the best channel for SU transmission without interfering with the PU transmissions. Yao *et al.* [13] introduced two different schemes for best channel selection and better performance: the channel occupancy statistics of the PU, and information about the level of competition between the SUs. In this scheme, SUs learn about their own competitive behavior using a two-step information exchange process. Then, the SUs can select the best channel for transmission using a fuzzy logic decision support system. In [14], a fuzzy logic-based dynamic framework was proposed for interaction between SUs and PUs, in which a multiple relay scheme is used to select the best channel for SUs transmissions without disturbing the QoS of the PUs. In this scheme, relative link quality (RLQ)

and signal-to-interference-plus-noise ratio (SINR) were used as input parameters for fuzzy logic-based decision making system.

Hawa *et al.* [15] proposed a distributed spectrum sharing scheme for CRNs. This scheme enables the SUs to select an appropriate channel in a distributed manner to minimize the interference issues and to achieve a high degree of fairness between the secondary base stations (SBSs). In [16], a fuzzy logic-based decision-making algorithm for channel selection was proposed. Therein, different parameters like mobility, noise, density, and channel selection probability are used as input. However, density is measured as the frequency of any channel used by the PU, and the distance between the PU and the SU base stations is represented as mobility. In [17], an architecture was simulated for dynamic spectrum management and was then implemented in a real-time scenario to achieve results in which distance, signal strength, and node velocity are the input parameters for fuzzy logic reinforcement learning to make the licensed channel selection. Jacob *et al.* [18] proposed a negotiation-based scheme to reduce the channel handoff rates. In order to reduce communication interruption at PU caused by SUs' mobility, the proposed scheme based on two fuzzy logic controllers: 1) price negotiation, and 2) duration negotiation. Another fuzzy logic-based channel selection scheme was proposed in [19]. This scheme takes channel selection decision based on SNR and power sensed from the PU transmitter. In the proposed scheme, the SU keeps sensing the power of the signal from the PU transmitter and also collects data from neighboring SUs.

In [20], a cooperative scheme for hopping sequence is proposed to reduce the effect of channel fading. Therein, SUs are clustered into hopping groups to sense the available spectrum and send results to a fusion center. The hopping group results are finally used to assign the channels with high, medium, and low ranks. Bharatula and Murugappan [21] proposed a multiple-attribute decision making scheme to choose the better network for SU transmissions. In the proposed scheme, different weights are assigned to each input parameter, such as delay, packet loss ratio (PLR), and price, according to the nature of the transmissions (e.g., audio, video, and data). In [22], another scheme was proposed to reduce overhead occur due to spectrum information-sharing between SUs and PUs in cooperative sensing environment. In this scheme, maximum ratio combining (MRC) and selection combining (SC) are used as input to the fuzzy fusion system to get sensed energy results. Maheshwari and Singh [11] proposed a distribution solution for SU mobility problem by using environmental properties. Chatterjee *et al.* [25] proposed a scheme to test a real-time environment, in which the PU detection probability is found better in a low-SINR region. Bhushan *et al.* [26] proposed solution for the fuzzy logic-based entropy maximization problem under dynamic spectrum sensing and utilization. In the proposed scheme, the dynamic threshold approach is used to analyze the CR-based communications process.

In the existing literature, most of the work was done for channel selection, PU detection and to reduce the channel switching rate while considering various parameters affecting the performance of the CRNs. However, a hybrid approach can ensure better channel utilization with minimum handoff rates. Furthermore, it can also ensure the suitable channel selection using parameters that have great influence on these two phenomena to improve that which is lacking. This paper resolves the issue of minimizing the channel switching rate by using two effective approaches. First, we use the interweave approach by selecting the best channel for transmission. Second, we use the underlay approach by minimizing the SU's transmission power to increase the final throughput of the network while minimizing the channel handoff rates.

### III. SYSTEM MODEL

Our system model comprises a primary network (PN) and a secondary network (SN). Therein, the PN consists of  $N$  PUs, and the SN consists of  $M$  SUs. We use a hybrid channel selection approach that includes characteristics of both overlay and underlay channel models. The PU is a privileged user and can use its licensed channel any time without interruption. However, the SU is an opportunistic user, and can only exploit the licensed channel when the PU is not using it or when its generated interference remains below a predefined threshold. If the SU's generated interference goes beyond the specified limit, then, the SU needs to vacate the licensed channel, and thereafter, must find some other suitable channel for its subsequent transmissions.

The SUs are mobile and have self-configuring abilities. Therefore, we use random waypoint as the mobility model, which represents the properties of next-generation wireless networks by characterizing the mobility of random nodes, showing that their locations, accelerations, and velocities can vary with time. Moreover, SUs maintain a list of usable channels and update it periodically after a certain time period,  $t$ . The SU makes a channel selection decision (or handoff) based on the parameters  $Ch_{Rank}$  and  $Ch_{tr}$  to assign values (i.e., high, medium, or low) to every channel in the list based on the properties of that particular channel (e.g., transmission range, idle time, channel capacity, noise, and interference rate). We assume an error-free channel model, and that data packet loss happens only due to PU-SU collision. Furthermore, we assume that the quasi-static Rayleigh fading is present, and the channel coefficients between communicating SU pair are considered to be independent Rayleigh distributed variables.

### IV. PROPOSED FUZZY-BASED CHANNEL SELECTION AND SWITCHING DECISION SYSTEM

In this section, we first present a short working discussion about fuzzy logic and then, we present our selected parameters, which we select to minimize the SU channel switching rates and to improve the throughput of the system while selecting the best available channel. We further discuss the architecture and workings of the proposed FLB-DSS,

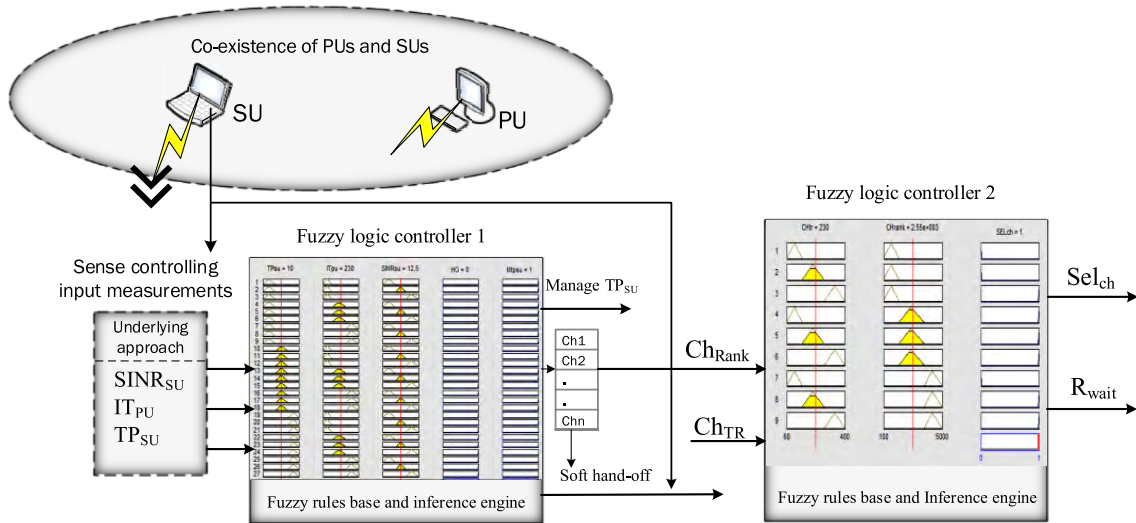

FIGURE 2. Proposed fuzzy logic-based decision support system.

which comprises two fuzzy logic controllers (fuzzy logic controller 1 and fuzzy logic controller 2), as shown in Figure 2.

**A. SIGNIFICANCE AND WORKING OF FUZZY LOGIC**

In this section, we briefly present the working of the fuzzy logic. The basic purpose of the discussion is to deliver the elementary information required to understand the basics of fuzzy logic. Fuzzy logic is known as a purely mathematical tool that is used most appropriately for decision making in scenarios where all the input values are imprecise and qualitatively uncertain. Moreover, the information received from the SU is in mostly heterogeneous form, and a fuzzy logic

mathematical tool has a quality to transform heterogeneous input into basic homogeneous membership functions. Later, crisp results can be produced using inference fuzzy rules. The objective of the fuzzy logic scheme is to introduce smarter control systems considering the fact that, most of the time, actual problems can never be professionally stated with the use of mathematical models. However, in order to implement the decision making process, fuzzy logic controllers are used which further need input parameters in terms of fuzzy set.

A fuzzy set, which is a general form of a crisp set when all values have to be categorized into two basic groups, i.e., member values and non-member values. A set of linguistic control rules is an important part of an FLC that is based on expert knowledge in the form IF (antecedent) THEN (consequent). Figure 3 illustrates the general working modules of a fuzzy system. Generally, a fuzzy decision system is divided into three different phases (fuzzification, fuzzy reasoning, and defuzzification). The input values are first fuzzified using the predefined membership functions in the fuzzification phase. In fuzzy reasoning, fuzzy input sets are fed into a knowledge base, and it generates fuzzy output sets that are defuzzified to get the final crisp output. A general fuzzy logic controller contains the following simple modules:

- a fuzzifier,
- an inference engine,
- a defuzzifier
- a knowledge base.

The fuzzy set can minimize the vagueness of real-world scenarios. According to fuzzy logic theory, a value, *A*, will be part of a fuzzy set, *Z*, where the condition of being its member cannot always be true or false. It will be counted as the degree to which *A* belongs to set *Z*. In fuzzy sets, the degree of membership can be expressed within a set of intervals, [0, 1], where 0 and 1 are the extreme values of this interval, which correspondingly represent the total

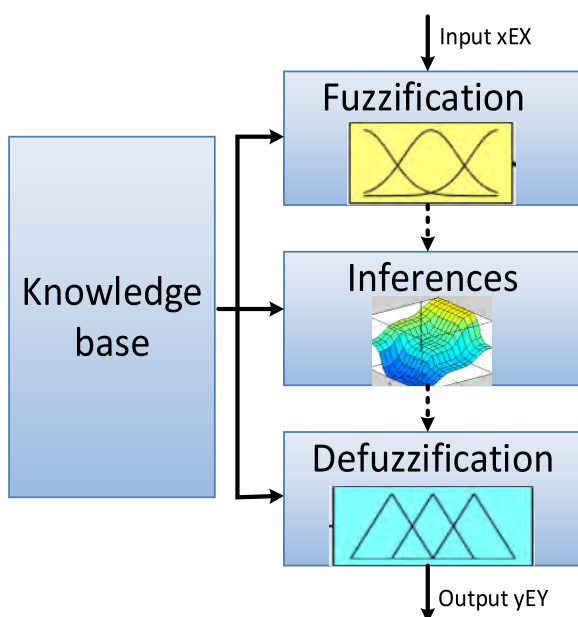

FIGURE 3. Fuzzy system architecture.

denial or acceptance of the membership in a fuzzy set. Every  $x$  object can be named as a linguistic term in a fuzzy set, where a linguistic term can be a word like *low*, *medium*, *high*, etc.; so,  $x$  can be defined as a linguistic variable. The term “set  $T(x)$ ” is used to describe each linguistic variable, and it can be a set of names for the linguistic values of  $x$ . Every single element in set  $T(x)$  is a fuzzy set. Let us consider a simple example in order to understand the concept of the fuzzy set and the membership functions. If speed can be interpreted as a linguistic variable, then we can define its set  $T(\text{speed})$  as  $T = \{\text{slow}, \text{moderate}, \text{fast}, \dots\}$ , where every term in  $T$  is a fuzzy set in the universal set of discourse [0, 100]. All these terms are characterized as fuzzy sets, and their membership functions are shown in Figure 2. Speed can be interpreted as slow when it falls below a certain value (i.e., 40 km/h), as moderate when the speed is close to 55 km/h, and as fast when the speed is more than about 70 km/h, as shown in Figure 4.

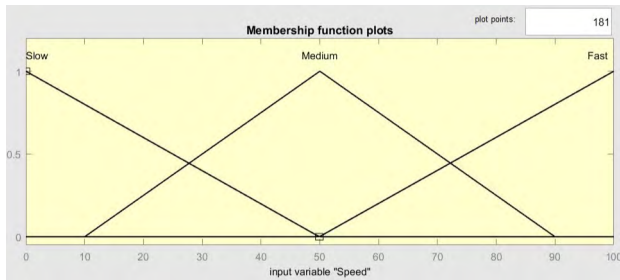

FIGURE 4. Membership function “Speed (km/h)”.

**B. PARAMETERS SELECTION**

This subsection presents our selected parameters. We select five parameters: 1)  $SINR_{SU}$ ,  $IT_{PU}$ ,  $TP_{SU}$ ,  $Ch_{Rank}$ , and  $Ch_{TR}$ .

- 1) **Interference Temperature:**  $IT_{SU}$  is defined as a measure of radio frequency (RF) power available at the receiving PU antenna. More specifically,  $IT_{SU}$  is also defined as temperature equivalent of the RF power available at the receiving PU’s antenna, measured in Kelvin [27].  $IT_{SU}$  is generated by the SU transmitter and other noise sources.  $IT_{SU}$  allows the SU and the PU to use the licensed channel simultaneously. However, the SU need to ensure that its generated interference is below a  $IT_{SU}$  threshold; otherwise, the SU immediately needs to vacate the operating licensed channel [1].  $IT_{SU}$  is calculated as follows [27]:

$$IT_{SU}(f_{ch}, B_{ch}) = \sum_{i=1}^{N_{SU+1}} \frac{P_i(f_{ch}, B_{ch})}{kB_{ch}} \quad (1)$$

where  $IT_{SU}(f_{ch}, B_{ch})$  is the interference temperature measured over the PU licensed channel,  $ch$ , where the central frequency is  $f_{ch}$  and the bandwidth is  $B_{ch}$ .  $N_{SU}$  is the number of SU transmitters producing interference with the PU.  $P_i(f_{ch}, B_{ch})$  is the average value of interference power measured in watts and  $k$  is Boltzmann’s

constant, the value of which is  $(1.38 \times 10^{-23})$  measured in joules per kelvin.

- 2) **SU Transmission Power:**  $TP_{SU}$  is the value of available power at which the SU can transmits its data towards the receiving SU antenna [23]. Controlling this parameter allows the SU to utilizes the licensed channel simultaneously while maintaining a certain QoS level for its transmissions. In case when no PU is operating over the licensed channel, the SU can transmits with the maximum power to improve the reception probability and to improve the QoS for its transmissions. However, if the received data at the SU is not successfully decoded. Then, the communicating pair of SUs need to switch to some other appropriate channel for their successful transmissions. The initial value of the  $TP_{SU}$  is calculated by using the path loss estimation and the common pilot channel (CPC) in the open-loop control cycle, which is given as follows [24]:

$$TP_{SU} = TP_{cpc} - TP_{cpc}^{R_x} - L_{glt} + SINR_{Req} + M_{SU} + \sum_i l_i \quad (2)$$

where  $TP_{SU}$  is the initial value of the power for the SU transmitter, and  $TP_{cpc}$  is the predetermined power value of the CPC.  $TP_{cpc}^{R_x}$  is measured power of the CPC at the receiving SU antenna, and  $L_{glt}$  represents an additional gain, tolerance, and loss.  $SINR_{Req}$  is the value of required SINR, and  $M_{SU} + \sum_i l_i$  is the value of calculated noise plus interference at the SU. The initial value of  $TP_{SU}$  is used for initial communication between the communicating pair nodes, and later on, this value can adjusted to avoid the harmful interference with the PU and other SUs operating over that particular licensed channel.

- 3)  **$SINR_{SU}$ :** To ensure the SU transmission power below a given threshold while maintaining a certain QoS level at SU receiving antenna is critical and challenging task. However, SINR measured at the SU receiving antenna can be used to determine the QoS of SU transmissions. Moreover, it can be use to determine the minimum value of transmission power required by SU to minimize the potential interference with the PU. Thus, controlling the SINR parameter permits the SU to simultaneously utilizes the licensed channel while maintaining a certain QoS level for its own transmissions too [28].  $SINR_{SU}$  measured at the SU receiving antenna is given in Eq. (3) see next top of the page, [24]. Where  $N$  and  $K$  represent number of co-channel PU and SU users.  $|h_{ij}|^2$  is power gain of fading channel coefficients.  $TP_{SU-B}$ , and  $TP_{SU-i}$  are transmitted powers of the co-channel SUs, and  $\sigma_{SU-B}^2$  is the variance of additive white Gaussian noise at the SU.
- 4)  **$Ch_{Rank}$ :** Provides the PU activity-aware channels availability [29]. Channel indexed under  $Ch_{Rank}$  are more stables and provide fewer collisions as well as less

$$SINR_{SU} = \frac{|h_{22}|_B^2 TP_{SU-B}}{\sum_{i=1, i \neq B}^N |h_{22}|_i^2 TP_{SU-i} + \sum_{j=1}^K |h_{11}|_j^2 TP_{SU-j} + \sigma_{SU-B}^2} \quad (3)$$

interference with PUs. Thus, selecting a channel based on  $Ch_{Rank}$  provides the minimum channel switching rates as well as the opportunity to make known switching decisions.  $Ch_{Rank}$  is calculated as follows [29]:

$$Ch_R = \frac{TFT_t^{ch}}{(TUT_t^{ch} \times No\ of\ Arrivals_t^{ch}) + TFT_t^{ch}} \quad (4)$$

where  $TFT_t^{ch}$  is the total idle time, and  $TUT_t^{ch}$  is the total busy time measured over channel  $ch$  at time  $t$ .  $No\ of\ Arrivals_t^{ch}$  denotes the total value for all arrivals of the PU detected over channel  $ch$  in time period  $t$ .

- 5) **Channel Transmission Range ( $Ch_{TR}$ ):** Channels available to the SUs are remarkably heterogeneous in terms of channel error rates and transmission ranges [7], [30]. Moreover, channels having lower transmission ranges are located in higher frequency bands. Therefore,  $Ch_{TR}$  has a significant impact on channel switching under the SU mobility. Hence, channel selection based on  $Ch_{TR}$  can significantly reduce the channel switching rate by providing sufficient transmission range to cover the communicating pair of SU nodes.

Our proposed FLB-DSS which is not only focuses on minimizing the channel handoff rates but also considers the best and most appropriate channel for the SU transmission to increase throughput. The following subsections discuss our proposed fuzzy logic controllers, their input parameters, and their output.

### C. PROPOSED FUZZY LOGIC CONTROLLERS

- 1) **Fuzzy Logic Controller 1:** The first fuzzy logic controller (FLC1) is designed to make a qualitative estimation of the power at which the SU transmits its data without interfering with the other transmissions of the PU and SUs while maintaining a certain QoS for its own transmissions. The objective of FLC1 is to minimize the channel switching rate while adjusting  $TP_{SU}$  in overlay transmissions, which happens only when the SU's transmission is ongoing and the PU has also arrived, and thus, the SU has to either keep using the channel according to the underlay approach or immediately switch to some other appropriate channel by making the decision to hand off. The FLC1 takes the fuzzy inference rules shown in Table 1 as input and takes the

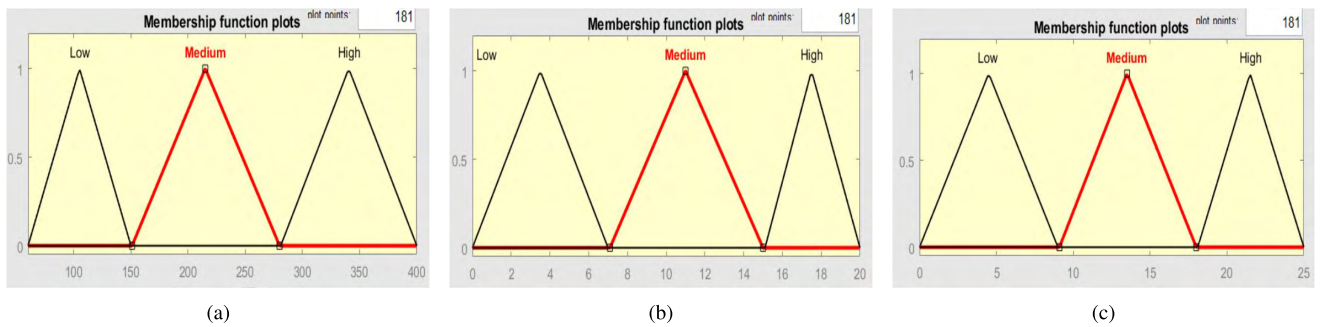

FIGURE 5. Membership functions for FLC1. (a) Membership function  $IT_{PU}$ . (b) Membership function  $TP_{SU}$ . (c) Membership function  $SINR_{SU}$ .

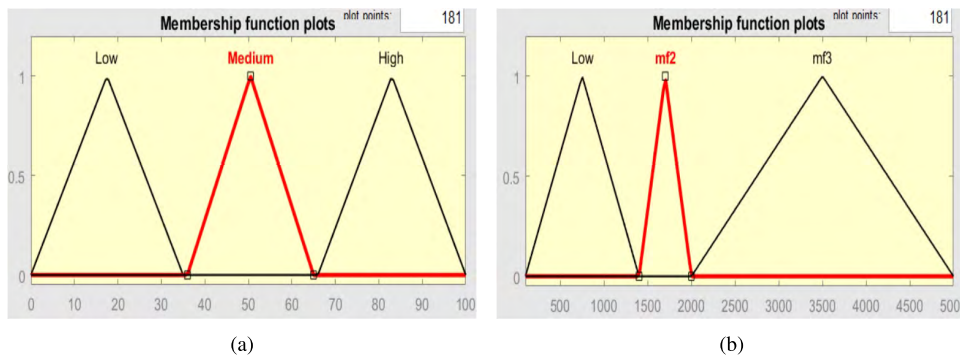

FIGURE 6. Membership functions for FLC2. (a) Membership function  $Ch_{Rank}$ . (b) Membership function  $Ch_{TR}$ .

TABLE 1. Inference rules for FLC1.

Rule no.	$TP_{SU}$	$IT_{PU}$	$SINR_{SU}$	$MTP_{SU}$	$HO$
1,2,3	Lw	Lw	Lw, Med, Hgh	✓	
4,5,6	Lw	Med	Lw, Med, Hgh	✓	
7	Lw	Hgh	Lw		✓
8,9	Lw	Hgh	Med, Hgh	✓	
10	Med	Lw	Lw	✓	
11	Med	Lw	Med	✓	
12	Med	Lw	Hgh		✓
13, 14	Med	Med	Lw, Med	✓	
15	Med	Med	Hgh		✓
16	Med	Hgh	Lw		✓
17, 18	Med	Hgh	Med, Hgh	✓	
19	Hgh	Lw	Lw		✓
20	Hgh	Lw	Med	✓	
21	Hgh	Lw	Hgh		✓
22, 23, 24	Hgh	Med	Lw, Med, Hgh		✓
25, 26, 27	Hgh	Hgh	Lw, Med, Hgh		✓

appropriate decision to manage  $TP_{SU}$ , or to otherwise hand off. In the case of a handoff, the workings of the FLC2 take place. The input parameters of the FLC1 and their corresponding membership functions are shown in Figure 5.

- 2) **Fuzzy Logic Controller 2:** The FLC2 is designed to select the best channel from the list of available channels, which allows the SU to utilize a channel for a long time and eventually minimizes the channel switching rate. When the SU has to select a new channel for

TABLE 2. Inference rules for FLC2.

Rule no.	$Ch_{Rank}$	$Ch_{TR}$	$SEL_{ch}$	$R_{wait}$
1	Lw	Lw		✓
2	Lw	Med		✓
3	Lw	Hgh	✓	
4	Med	Lw	✓	
5	Med	Med	✓	
6	Med	Hgh	✓	
7	Hgh	Lw		✓
8	Hgh	Med	✓	
9	Hgh	Hgh	✓	

seamless transmission, it considers  $Ch_{Rank}$  and  $Ch_{TR}$  as input parameters. After that, it puts them into the fuzzifier to get the membership functions or antecedents. The inference engine applies the fuzzy rules presented in Table 2 on antecedents, and forwards the antecedent to the defuzzifier to get the crisp consequent on which the SU will make the most appropriate decision. The input parameters and the corresponding membership functions of FLC2 are shown in Figure 6.

V. PERFORMANCE EVALUATION

We evaluated the performance of the proposed scheme against the conventional scheme by using Matlab, which is a meta-paradigm numerical computing environment using fourth-generation programming language. The conventional, or baseline, scheme operates only on an overlay channel selection model. It exploits the licensed channel when no PU is operating on it, and vacates licensed channels immediately when the PU arrives. We evaluated the performance in

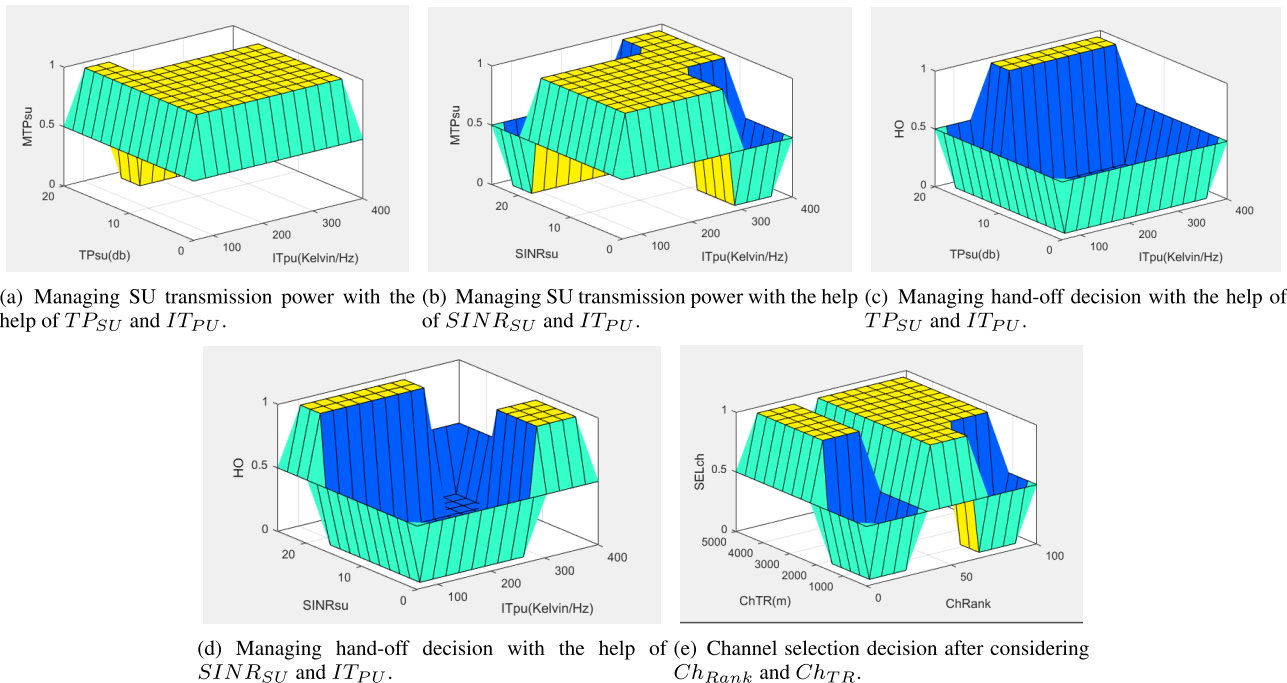

FIGURE 7. Matlab implementation of inference rules for FLC1 and FLC2 by using the Mumtaz inference engine. Figures 7 (a)-(d) show the results of inference rules for FLC1, taking the input values of  $TP_{SU}$ ,  $IT_{PU}$ , and  $SINR_{SU}$  resulting in the consequent decision to manage the transmission power of the SU and taking hand-off decision. Figure 7 (e) presents the results of the inference rules for FLC2 taking the input values of  $Ch_{Rank}$  and  $Ch_{TR}$ , resulting in the consequent decision on channel selection.



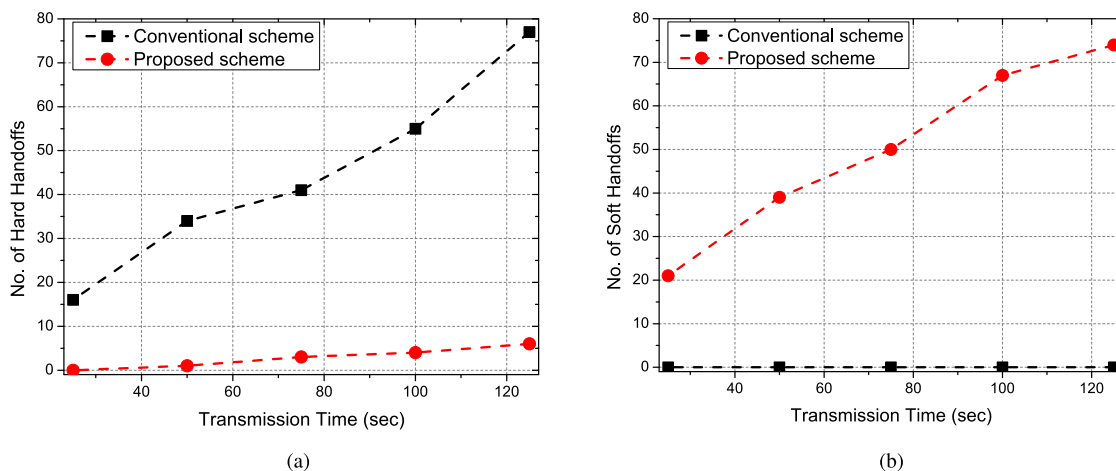

FIGURE 8. Number of handoffs proposed vs. the conventional scheme under varying transmission times. (a) Number of hard handoffs. (b) Number of soft handoffs.

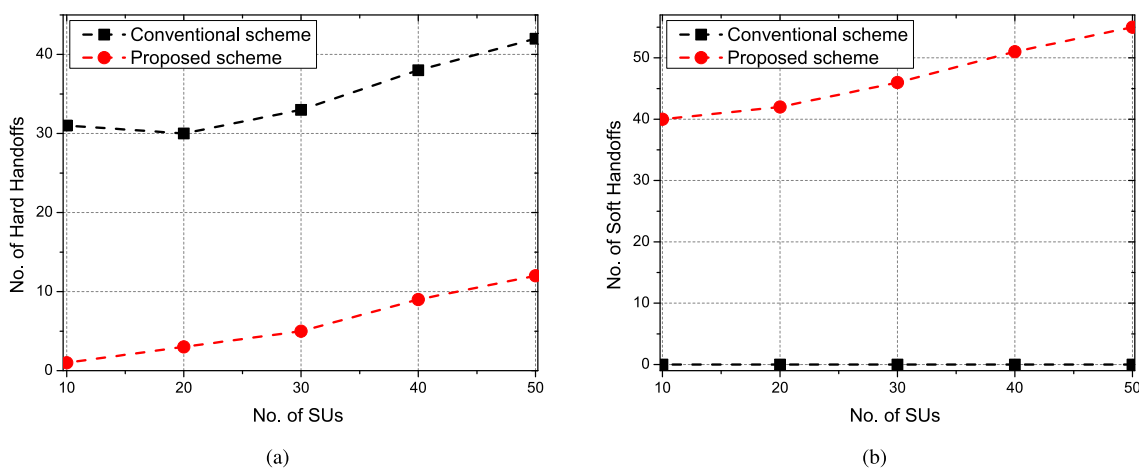

FIGURE 9. Number of handoffs proposed vs. the conventional scheme under varying number of SUs. (a) Number of hard handoffs. (b) Number of soft handoffs.

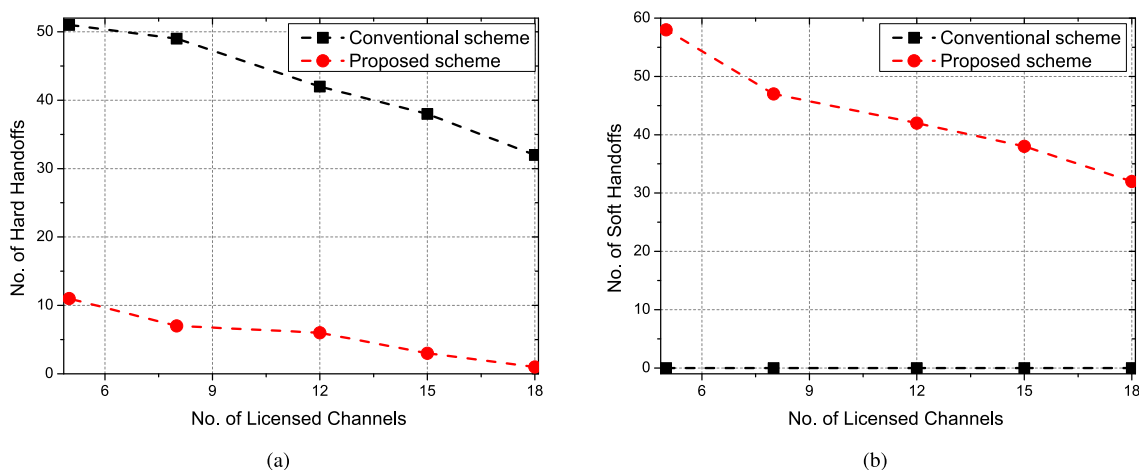

FIGURE 10. Number of handoffs proposed vs. the conventional schemes under varying number of licensed channels. (a) Number of hard handoffs. (b) Number of soft handoffs.

terms of 1) the number of hard handoffs, 2) the number of soft handoffs, 3) the time used in channel searching, selecting, and switching to resume suspended (or start new) transmissions,

and 4) system throughput. Vacating the licensed channel instantly upon the arrival of the PU and switching to some other available licensed channel later is referred as a hard

handoff, whereas selecting the best channel from a list of available channels before vacating the operating channel is referred as a soft handoff. Time used in channel selection and switching in order to resume a suspended transmission, or start a new one, is the delay/time calculated starting from vacating the operating licensed channel till selecting and switching to another channel. It takes channel search time, channel selection time, and communicating with the node pair about the new channel in order to resume suspended transmissions. Throughput is measured as the number of packets received successfully at the receiving (destination) SU node in unit time.

Figure 8 presents the simulation results for hard and soft handoff rates under the proposed and conventional schemes for varying transmission times. In figures 8 (a)-(b), the results evaluated were for 120 seconds of SU data transmissions by 10 SU nodes using five licensed channels. Due to the proactive channel searching, selection, and switching adopted in our proposed scheme, it outperformed the conventional scheme. However, in Figure 8 (a), a few hard handoffs happened under our proposed scheme, because sometimes the generated interference by the operating SU exceeded the

given threshold, and the SU and the PU cannot operate on the same channel simultaneously.

Figures 9 and 10 present a performance analysis of the proposed and the conventional schemes when varying the number of SUs and when varying the number of licensed channels, respectively. Figures 9 (a)-(b) are an evaluation of

TABLE 3. Simulation settings.

Parameters	Values
Simulation Area	1000 × 1000 m
Simulation total time	25-125 s
Number of PUs	5-18 (each licensed channel correspond to its single PU)
Number of SUs	10-50
PU detection time	1 ms
Detection threshold value	1.16 db
Time required for channel searching, selecting, and switching	5 s
SU Waiting time when no licensed channel is idle	5 s
Mobility model	Random way point
Pause time	0-100 ms
Node speed	0.5-5 m/sec
Channel capacity	2 Mbps
Packet size	1024 bytes

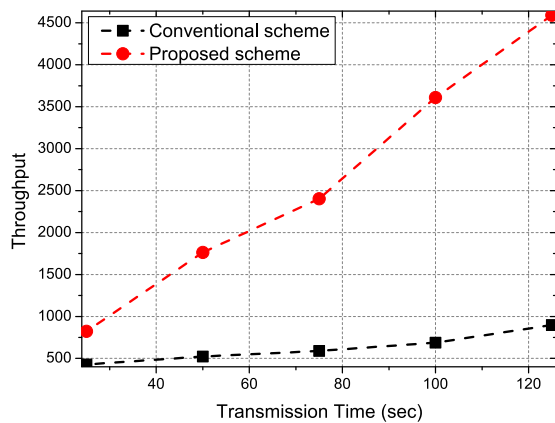

(a)

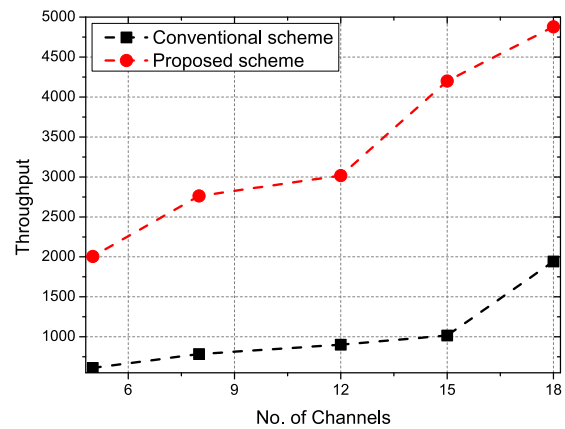

(b)

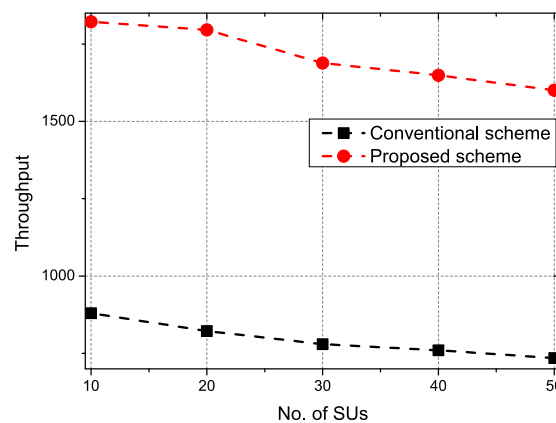

(c)

FIGURE 11. Throughput for the proposed vs. the conventional scheme. (a) Throughput under varying transmission times. (b) Throughput under varying number of licensed channels. (c) Throughput under varying number of SUs.

five licensed channels used for 50 seconds of data transmissions. Figure 9 (a) shows that the number of hard handoffs increases under the proposed scheme with an increase in the number of SUs. This happens because sometimes licensed channels become unavailable for prior-switching decisions when all licensed channels are occupied by other SUs, or they become unavailable for SUs' transmissions by exceeding the interference threshold limit of the operating PU. Hence, the PU and the SU cannot execute transmissions simultaneously. Figures 10 (a)-(b) evaluated fewer than 30 SUs for 50 seconds of data transmissions. However, the number of licensed channels varies between five and 18. Figure 10 (a) demonstrates that the number of hard handoffs decreases with an increase in the number of licensed channels. This happens because more licensed channels are available for switching decisions. Figures 9 and 10 show that the proposed scheme performs better in terms of hard- and soft-handoff rates when varying the number of operating SUs and the number of licensed channels.

Figures 11 (a)-(c) present the throughput analysis of the proposed and conventional schemes when varying the transmission times, varying the number of usable licensed chan-

nels, and varying the number of operating SUs, respectively. In Figure 11 (a), throughput is measured for 10 pairs of SUs operating over five licensed channels for total 125 seconds of data transmissions. Figure 11 (a) shows that the proposed scheme performs better in terms of successfully transmitting data packets. This is because the proposed scheme selects the best channel based on susceptibility (e.g., the duration of its availability) and the channel transmission range. The channel that will be less susceptible to PU transmissions will be available for a longer time, and thus, provides less channel switching and also provides a sufficient range to cover transmissions with the communicating SU node pair. Moreover, the parameter  $Ch_{Rank}$  provides an opportunity to take a soft handoff decision based on the known availability time of the operating licensed channel. Hence, the fewer hard handoff decisions lead to spending less time searching for and selecting a new channel, and eventually increases the throughput of the system.

Figure 11(b) plots the throughput results for 30 pairs of SUs communicating for a total of 50 seconds. Figure 11(b) shows that increasing the number of licensed channels provides more opportunities to select the best channels in

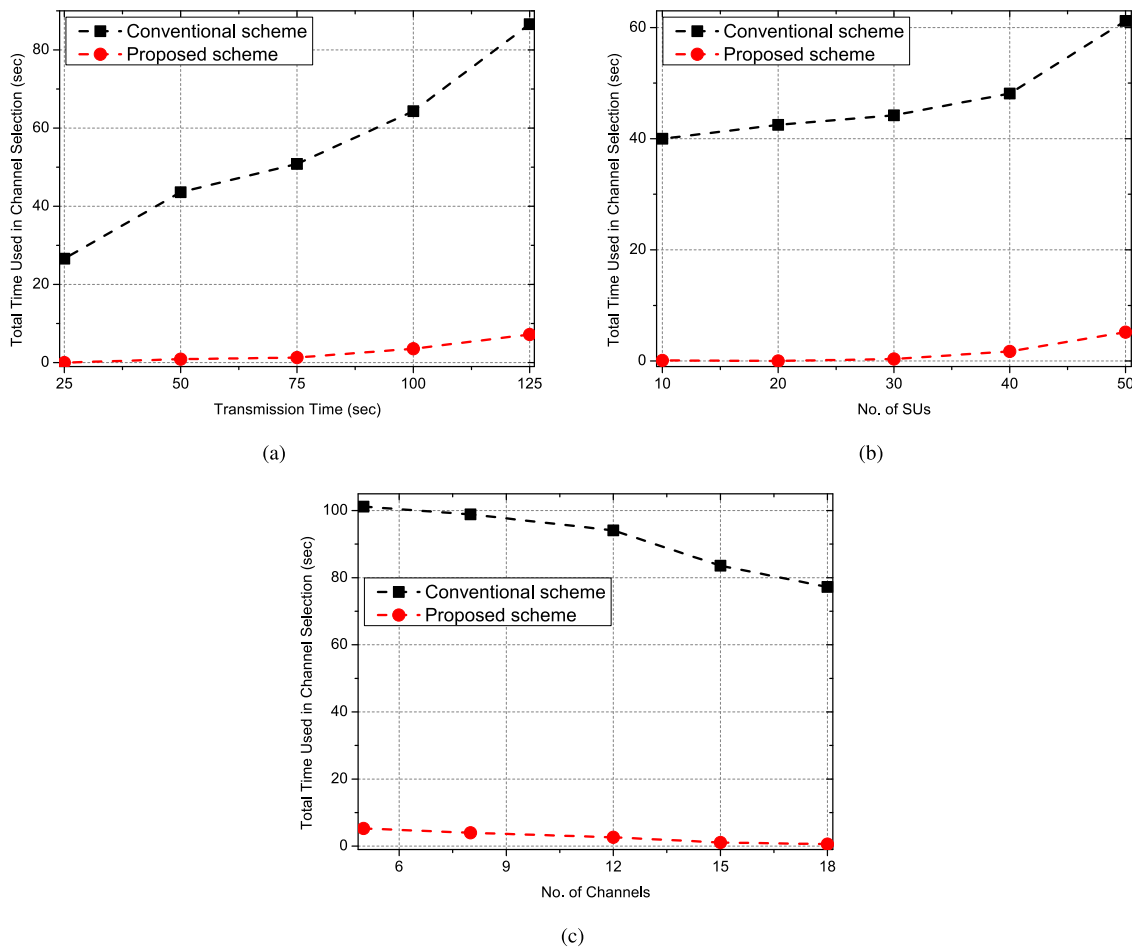

**FIGURE 12.** Time consumed for channel selection in the proposed vs. the conventional scheme. (a) Time consumed in channel selection under varying transmission times. (b) Time consumed in channel selection under varying number of SUs. (c) Time consumed in channel selection under varying number of licensed channels.

terms of long availability and better coverage range, which sufficiently increases the system's overall throughput. Figure 11(c) presents the throughput analysis when varying the number of SUs for a transmission period of 50 seconds over five licensed channels. Figure 11(c) shows that the proposed scheme still performs better under an increasing number of SUs over the limited availability of operating licensed channels. However, the throughput of the system decreases with an increase in the number of SUs due to the unavailability or lesser availability of channels.

Figures 12 (a)-(c) present a performance analysis of the proposed scheme and the conventional scheme in terms of SUs' total time spent in channel searching, selection, and switching under varying transmission times, varied numbers of operating SUs, and varied numbers of usable licensed channels, respectively. In Figure 12 (a), time is measured for 10 pairs of SUs transmitting data for the total of 125 seconds by using five licensed channels. Figure 12 (a) shows that the conventional scheme spends a lot of time in the channel searching, selection, and switching processes. The more time SUs spend in switching may seriously affect the overall performance of the system. The conventional scheme makes more switching decisions because it only selects licensed channels for SU communications based on availability and does not consider other important parameters, such as channel susceptibility value, duration of availability, and coverage range. Moreover, the conventional scheme needs to vacate a licensed channel immediately upon the arrival of its licensed user. However, the proposed scheme selects the best channel from the list of available channels based on  $Ch_{Rank}$  and  $Ch_{TR}$ , which not only offers it the opportunity of using the selected channel for a longer time but also allows soft handoff decisions.

With a soft handoff decision, the communicating SU starts searching for other options in channel switching before leaving the currently licensed channel. Thus, the proposed scheme utilizes more time for data transmissions, rather than wasting time searching and switching among the available channels. Moreover, under the proposed scheme, the SU keeps transmitting data on the licensed channel simultaneously with the PU by controlling its generated interference, keeping it below the specified threshold, which it observes by considering the  $IT_{PU}$  and  $TP_{SU}$  parameters. Furthermore, the proposed scheme does not make a channel switching decision until the operating licensed channel fulfills its minimum requirements for quality of transmission, which we measure by using the  $SINR_{SU}$  parameter. Figures 12 (b)-(c) measure the time spent channel searching, selecting, and switching when varying the numbers of SUs and licensed channels, respectively. Figure 12 (b) plots the results for five licensed channels available for SU data transmissions for a total of 50 seconds. Similarly, Figure 12 (c) presents the results for 30 SUs' data transmissions for a total of 50 seconds. It is clear from Figures 12 (b) and (c) that the proposed scheme outperforms the conventional scheme in terms of efficient time utilization.

## VI. CONCLUSION

Cognitive radio is an emerging technology to fulfill the increasing demand for a scarce spectrum resources in future networks. A valuable amount of spectrum resources is always wasted by rightful users, so to resourcefully utilize these frequency bands, we proposed an efficient spectrum utilization scheme with the objectives to provide minimum number of handoffs, and to ensure a certain level of quality of service for SU transmissions. Our simulation results and the evaluation proved that the fuzzy logic decision support system is more sophisticated tool to improve the throughput of brain-empowered cognitive radio networks. Our proposed scheme has shown more effective results, compared to a conventional cognitive radio network that makes its decisions on spectrum utilization based upon vague and imprecise sensing results taken by secondary users.

## REFERENCES

- [1] A. Ali et al., "RaptorQ-based efficient multimedia transmission over cooperative cellular cognitive radio networks," *IEEE Trans. Veh. Technol.*, vol. 67, no. 8, pp. 7275–7289, Aug. 2018.
- [2] J. Mitola and G. Q. Maguire, Jr., "Cognitive radio: Making software radios more personal," *IEEE Pers. Commun.*, vol. 6, no. 4, pp. 13–18, Apr. 1999.
- [3] S. Haykin, "Cognitive radio: Brain-empowered wireless communications," *IEEE J. Sel. Areas Commun.*, vol. 23, no. 2, pp. 201–220, Feb. 2005.
- [4] A. Ali and W. Hamouda, "Advances on spectrum sensing for cognitive radio networks: Theory and applications," *IEEE Commun. Surveys Tuts.*, vol. 19, no. 2, pp. 1277–1304, 2nd Quart., 2016.
- [5] M. E. Tanab and W. Hamouda, "Resource allocation for underlay cognitive radio networks: A survey," *IEEE Commun. Surveys Tuts.*, vol. 19, no. 2, pp. 1249–1276, 2nd Quart., 2017.
- [6] P. Thakur, A. Kumar, S. Pandit, G. Singh, and S. N. Satashia, "Performance analysis of high-traffic cognitive radio communication system using hybrid spectrum access, prediction and monitoring techniques," *Wireless Netw.*, vol. 24, no. 6, pp. 2005–2015, 2017.
- [7] A. Ali et al., "Channel clustering and QoS level identification scheme for multi-channel cognitive radio networks," *IEEE Commun. Mag.*, vol. 56, no. 4, pp. 164–171, Apr. 2018.
- [8] W. Liang, S. X. Ng, and L. Hanzo, "Cooperative overlay spectrum access in cognitive radio networks," *IEEE Commun. Surveys Tuts.*, vol. 19, no. 3, pp. 1924–1944, 3rd Quart., 2017.
- [9] Q. Zhao and A. Swami, "A survey of dynamic spectrum access: Signal processing and networking perspectives," in *Proc. IEEE Int. Conf. Acoust., Speech Signal Process. (ICASSP)*, Apr. 2007, pp. IV-1349–IV-1352.
- [10] K. Chatzikokolakis, P. Spapis, A. Kaloxylos, and N. Alonistioti, "Toward spectrum sharing: Opportunities and technical enablers," *IEEE Commun. Mag.*, vol. 53, no. 7, pp. 26–33, Jul. 2015.
- [11] P. Maheshwari and A. K. Singh, "A fuzzy logic based approach to spectrum assignment in cognitive radio networks," in *Proc. IEEE Int. Conf. Advance Comput. Conf. (IACC)*, Jun. 2015, pp. 278–281.
- [12] G. P. Joshi, S. Acharya, and S. W. Kim, "Fuzzy-logic-based channel selection in IEEE 802.22 WRAN," *Inf. Syst.*, vol. 48, pp. 327–332, Mar. 2015.
- [13] Y. Yao, A. Popescu, and A. Popescu, "On fuzzy logic-based channel selection in cognitive radio networks," in *Handbook of Research on Software-Defined and Cognitive Radio Technologies for Dynamic Spectrum Management*. IGI Global, 2015, pp. 255–274.
- [14] J. S. Banerjee, A. Chakraborty, and A. Chattopadhyay, "Fuzzy based relay selection for secondary transmission in cooperative cognitive radio networks," in *Advances in Optical Science and Engineering*. Singapore: Springer, 2017, pp. 279–287.
- [15] M. Hawa, A. AlAmmouri, A. Alhiary, and N. Alhamad, "Distributed opportunistic spectrum sharing in cognitive radio networks," *Int. J. Commun. Syst.*, vol. 30, no. 7, p. e3147, 2017.
- [16] M. E. Bayrakdar and A. Calhan, "Fuzzy logic based channel selection for mobile secondary users in cognitive radio networks," in *Proc. 23rd Signal Process. Commun. Appl. Conf. (SIU)*, May 2015, pp. 331–334.
- [17] H. Yang, Y. Liang, J. Miao, and D. Zhao, "Radio spectrum management for cognitive radio based on fuzzy neural methodology," in *Proc. Conf. Complex, Intell., Softw. Intensive Syst.*, Jul. 2017, pp. 609–616.

- [18] J. Jacob, B. R. Jose, and J. Mathew, "A fuzzy approach to decision fusion in cognitive radio," *Procedia Comput. Sci.*, vol. 46, pp. 425–431, Dec. 2015.
- [19] A. A.-H. Khader, A. H. Reja, A. A. Hussein, and M. T. Beg, "Cooperative spectrum sensing improvement based on fuzzy logic system," *Procedia Comput. Sci.*, vol. 58, pp. 34–41, Aug. 2015.
- [20] K. Kumar, A. Prakash, and R. Tripathi, "Spectrum handoff scheme with multiple attributes decision making for optimal network selection in cognitive radio networks," *Digit. Commun. Netw.*, vol. 3, no. 3, pp. 164–175, 2017.
- [21] S. Bharatula and M. Murugappan, "An intelligent fuzzy based energy detection approach for cooperative spectrum sensing," *Circuits Syst.*, vol. 7, no. 6, pp. 1042–1050, 2016.
- [22] R. Elgadi, A. R. Hilal, and O. Basir, "A fuzzy logic approach for cooperative spectrum sensing in cognitive radio networks," in *Proc. IEEE 30th Can. Conf. Elect. Comput. Eng. (CCECE)*, Apr./May 2017, pp. 1–4.
- [23] M. Xie, W. Zhang, and K.-K. Wong, "A geometric approach to improve spectrum efficiency for cognitive relay networks," *IEEE Trans. Wireless Commun.*, vol. 9, no. 1, pp. 268–281, Jan. 2010.
- [24] Z. Tabakovic, S. Grgic, and M. Grgic, "Fuzzy logic power control in cognitive radio," in *Proc. 16th Int. Conf. Syst., Signals Image Process.*, Jun. 2009, pp. 1–5.
- [25] S. Chatterjee, S. P. Maity, and T. Acharya, "On optimal threshold selection in cooperative spectrum sensing for cognitive radio networks: An energy detection approach using fuzzy entropy maximization," *Wireless Pers. Commun.*, vol. 84, no. 3, pp. 1605–1625, 2015.
- [26] S. Bhushan, R. S. Bali, and A. Kaur, "Spectrum hand off in cognitive radio network using dynamic threshold," in *Proc. Int. Conf. Green Comput. Internet Things (ICGCIoT)*, Oct. 2015, pp. 1292–1297.
- [27] T. Clancy, "Formalizing the interference temperature model," *Wireless Commun. Mobile Comput.*, vol. 7, no. 9, pp. 1077–1086, Nov. 2007.
- [28] Z. Bao, B. Wu, P.-H. Ho, and X. Ling, "Adaptive threshold control for energy detection based spectrum sensing in cognitive radio networks," in *Proc. IEEE Global Telecommun. Conf. (GLOBECOM)*, Dec. 2011, pp. 1–5.
- [29] A. Ali, M. J. Piran, H. Kim, J. Yun, and D. Y. Suh, "PAD-MAC: Primary user activity-aware distributed MAC for multi-channel cognitive radio networks," *Sensors*, vol. 15, no. 4, pp. 7658–7690, 2015.
- [30] Y. Shi and Y. T. Hou, "Optimal power control for multi-hop software defined radio networks," in *Proc. 26th IEEE Int. Conf. Comput. Commun. (INFOCOM)*, May 2007, pp. 1694–1702.



**AMJAD ALI** received the B.S. and M.S. degrees in computer science from the COMSATS Institute of Information Technology, Pakistan, in 2006 and 2008, respectively, and the Ph.D. degree from the Electronics and Radio Engineering Department, Kyung Hee University, South Korea, in 2015. From 2018 to 2019, he was a Postdoctoral Research Scientist with the UWB Wireless Communications Research Center (formerly the Key National IT Research Center), Department of

Information and Communication Engineering, Inha University, South Korea, and also with the Mobile Network and Communications Lab, School of Electrical Engineering, Korea University, Seoul, South Korea. Since 2015, he has been an Assistant Professor with the Department of Computer Science, COMSATS University Islamabad, Lahore Campus, Pakistan. He has published many peer-reviewed international journal and conference papers. His main research interests include the Internet of Things, cognitive radio networks (interference modeling, dynamic spectrum access, power and admission control, spectrum management, spectrum trading, MAC protocols, performance modeling, and optimization), 5G cellular networks (spectrum/resource management, coexistence, distributed wireless access, scheduling, power control, network selection, and mobility/handover management), ad hoc social networks multimedia cloud computing, smart grid, and vehicular networks. He received the Excellent Research Contribution Award from the UWB Wireless Communications Research Center, for his excellent research performances. He is serving as a Reviewer for *IEEE Communications Magazine*, the *IEEE TRANSACTIONS ON INDUSTRIAL INFORMATICS*, the *IEEE TRANSACTIONS ON CIRCUITS AND SYSTEMS FOR VIDEO TECHNOLOGY*, the *IEEE TRANSACTIONS ON VEHICULAR TECHNOLOGY*, the *IEEE JOURNAL ON SELECTED AREAS IN COMMUNICATIONS*, the *IEEE INTERNET OF THINGS JOURNAL*, the *IEEE ACCESS*, the *IET Communications*, and *Computer Networks*. He is also serving as an Editorial Board Member for the *IEEE ACCESS*.



**LARAIB ABBAS** received the B.S. degree in information technology from the University of the Punjab, Pakistan, in 2012, and the M.S. degree in information technology from the University of Gujrat, Pakistan, in 2015, where she is currently pursuing the Ph.D. degree in computer science. Since 2013, she has been a Research Associate with the University of Gujrat. Her main research interests include cognitive radio networks, mobile ad-hoc networks, and deep learning.



**MUHAMMAD SHAFIQ** received the M.S. degree in computer science from the University Institute of Information Technology, Arid Agriculture University, Rawalpindi, Pakistan, the master's degree in information technology from the University of the Punjab, Gujranwala, Pakistan, and the Ph.D. degree in information and communication engineering from Yeungnam University, South Korea, in 2018. He was a Lecturer with the Department of Computer Science, Federal Urdu University, Islamabad, Pakistan. From 2010 to 2018, he was a Lecturer with the Department of Information Technology, University of Gujrat. He is currently a Postdoctoral Fellow with Yeungnam University and is also an Assistant Professor with the Faculty of Computer Science, GC Women University, Sialkot, Pakistan. His research interests include the design of spectrum management, routing, and medium access control protocols for mobile ad hoc networks, the Internet of Things, and cognitive radio networks.



**ALI KASHIF BASHIR** (SM'16) received the B.S. degree from the University of Management and Technology, Pakistan, the M.S. degree from Ajou University, South Korea, and the Ph.D. degree in computer science and engineering from Korea University, South Korea. He was an Associate Professor of information and communication technologies with the Faculty of Science and Technology, University of the Faroe Islands, Denmark; Osaka University, Japan; the Nara National

College of Technology, Japan; the National Fusion Research Institute, South Korea; Southern Power Company Ltd., South Korea; and the Seoul Metropolitan Government, South Korea. Since 2019, he has been a Senior Lecturer/Associate Professor with Manchester Metropolitan University, U.K. He is supervising/co-supervising several graduate (M.S. and Ph.D.) students. He has authored over 70 peer-reviewed articles. His research interests include the Internet of Things, wireless networks, distributed systems, network/cyber security, and cloud/network function virtualization. He is a Distinguished Speaker of ACM. He is serving as the Editor-in-Chief for the *IEEE Future Directions Newsletter*. He is an Editor of several journals and also has served/serving as a Guest Editor for several special issues in the journals of *IEEE*, *Elsevier*, and *Springer*. He has served as the Chair (Program, Publicity, and Track) for several conferences and workshops. He has delivered several invited and keynote talks and reviewed the technology leading articles for journals, such as the *IEEE TRANSACTIONS ON INDUSTRIAL INFORMATICS*, *IEEE Communication Magazine*, *IEEE COMMUNICATION LETTERS*, the *IEEE INTERNET OF THINGS*, and the *IEICE* journals, and conferences, such as the *IEEE Infocom*, the *IEEE ICC*, the *IEEE Globecom*, and the *IEEE Cloud of Things*.



**MUHAMMAD KHALIL AFZAL** (SM'16) received the B.S. and M.S. degrees in computer science from the COMSATS Institute of Information Technology, Wah Campus, Pakistan, in 2004 and 2007, respectively, and the Ph.D. degree from the Department of Information and Communication Engineering, Yeungnam University, South Korea, in 2014. He was a Lecturer with Bahaud-din Zakariya University, Multan, Pakistan, from 2008 to 2009, and King Khalid University, Abha,

Saudi Arabia, from 2009 to 2011. He is currently an Assistant Professor with the Department of Computer Science, COMSATS, Wah Cantonment, Pakistan. His research interests include wireless sensor networks, ad hoc networks, smart cities, and the Internet of Things. He is serving as a Guest Editor for *Future Generation Computer Systems* (Elsevier), *IEEE Communication Magazine*, the IEEE ACCESS, and the *Journal of Ambient Intelligence and Humanized Computing* (Springer), and as a Reviewer for the IEEE ACCESS, *Computers and Electrical Engineering* (Elsevier), the *Journal of Network and Computer Applications* (Elsevier), FGCS, and the IEEE TRANSACTIONS ON VEHICULAR TECHNOLOGY.



**HANNAN BIN LIAQAT** received the B.S. degree in information technology and the M.S. degree in computer networks from the COMSATS Institute of Information Technology, Lahore, Pakistan, in 2006 and 2009, respectively, and the Ph.D. degree from the Dalian University of Technology, Dalian, China, in 2016. From 2009 to 2011, he was a Lecturer with the Information Technology Department, University of Gujrat, Gujrat, Pakistan. Since 2016, he has been an Assistant Professor, a Ph.D. Supervisor, and an M.Phil. Supervisor with the Department of Information Technology, University of Gujrat. He has authored or co-authored a number of publications to his credits in international journals and conferences. His research interests include ad hoc social networks, the Internet of Things, cloud computing, mobile computing, and social computing. He is a Reviewer for several international journals.

He is a Reviewer for several international journals.



**MUHAMMAD HAMEED SIDDIQI** received the bachelor's degree (Hons.) in computer science from the Islamia College (a chartered university), Peshawar, Pakistan, in 2007, and the master's and Ph.D. degrees from the Ubiquitous Computing Laboratory, Department of Computer Engineering, Kyung Hee University, Suwon, South Korea, in 2012 and 2016, respectively. He was a Postdoctoral Research Scientist with the Department of Computer Science and Engineering,

Sungkyunkwan University, Suwon, in 2016. He was a Graduate Assistant with Universiti Teknologi PETRONAS, Malaysia, from 2008 to 2009. He is currently an Assistant Professor with the Department of Computer and Information Sciences, Jouf University, Sakakah, Saudi Arabia. He has published more than 50 research articles in highly reputable international journals and conferences. His research interests include image processing, pattern recognition, facial expression recognition, activity recognition, and machine intelligence. He is a Reviewer for different journals and conferences.



**KYUNG SUP KWAK** (S'10–M'11) received the Ph.D. degree from the University of California at San Diego, in 1988. From 1988 to 1989, he was with Hughes Network Systems, San Diego, CA, USA. From 1989 to 1990, he was with the IBM Network Analysis Center, Research Triangle Park, NC, USA. In 2006, he was the President of the Korean Institute of Communication Sciences, and in 2009, he was the President of the Korea Institute of Intelligent Transport Systems. In 2008, he had

been selected as the Inha Fellow Professor and currently as the Inha Hanlim Fellow Professor. Since 1991, he has been a Professor with the School of Information and Communication Engineering, Inha University, South Korea. He has been the Director of the UWB Wireless Communications Research Center (formerly the Key National IT Research Center), South Korea, since 2003. He has published more than 200 peer-reviewed journal papers. His research interests include wireless communications, UWB systems, sensor networks, WBAN, and nano-communications. He was a recipient of a number of awards, including the Engineering College Achievement Award from Inha University, the LG Paper Award, the Motorola Paper Award, and the Haedong Prize of Research, for his excellent research performances.

...