

Received April 20, 2018, accepted May 23, 2018, date of publication May 28, 2018, date of current version July 12, 2018.

Digital Object Identifier 10.1109/ACCESS.2018.2841407

# Review of Energy Storage System Technologies in Microgrid Applications: Issues and Challenges

MOHAMMAD FAISAL<sup>1</sup>, MAHAMMAD A. HANNAN<sup>1</sup>, (Senior Member, IEEE),  
PIN JERN KER<sup>1</sup>, AINI HUSSAIN<sup>2</sup>, (Member, IEEE), MUHAMAD BIN MANSOR<sup>1</sup>,  
AND FREDE BLAABJERG<sup>3</sup>, (Fellow, IEEE)

<sup>1</sup>Department of Electrical Power Engineering, College of Engineering, Universiti Tenaga Nasional, Kajang 43000, Malaysia

<sup>2</sup>Centre for Integrated Systems Engineering and Advanced Technologies, Faculty of Engineering and Built Environment, Universiti Kebangsaan Malaysia, Bangi 43600, Malaysia

<sup>3</sup>Department of Energy Technology, Aalborg University, 9220 Aalborg, Denmark

Corresponding author: M. A. Hannan (hannan@uniten.edu.my)

This work was supported by Tenaga Nasional Berhad Seed Funding Grant under Universiti Tenaga Nasional Grant U-TG-RD-18-04.

**ABSTRACT** A microgrid (MG) is a local entity that consists of distributed energy resources (DERs) to achieve local power reliability and sustainable energy utilization. The MG concept or renewable energy technologies integrated with energy storage systems (ESS) have gained increasing interest and popularity because it can store energy at off-peak hours and supply energy at peak hours. However, existing ESS technology faces challenges in storing energy due to various issues, such as charging/discharging, safety, reliability, size, cost, life cycle, and overall management. Thus, an advanced ESS is required with regard to capacity, protection, control interface, energy management, and characteristics to enhance the performance of ESS in MG applications. This paper comprehensively reviews the types of ESS technologies, ESS structures along with their configurations, classifications, features, energy conversion, and evaluation process. Moreover, details on the advantages and disadvantages of ESS in MG applications have been analyzed based on the process of energy formations, material selection, power transfer mechanism, capacity, efficiency, and cycle period. Existing reviews critically demonstrate the current technologies for ESS in MG applications. However, the optimum management of ESSs for efficient MG operation remains a challenge in modern power system networks. This review also highlights the key factors, issues, and challenges with possible recommendations for the further development of ESS in future MG applications. All the highlighted insights of this review significantly contribute to the increasing effort toward the development of a cost-effective and efficient ESS model with a prolonged life cycle for sustainable MG implementation.

**INDEX TERMS** Energy storage system, microgrid, distributed energy resources, ESS technologies, energy management.

## I. INTRODUCTION

The rapid growth of energy consumption, CO<sub>2</sub> emissions, and demand-supply mismatch globally is due to the rising population growth rate and urbanization levels [1]. These issues require development to optimize energy use and minimize fuel consumption and toxic emissions [2]. Various alternatives to the use of fossil fuels have been proposed to achieve sustainable energy systems [3], [4]. Renewable energy (RE) technologies with energy storage systems (ESSs) have become widely endorsed solutions among these alternatives [5]–[7]. ESS assists renewable energy integration in many ways and manages the decent power balance during a power crisis; thus, the stability of the system has a significant effect on the overall electric system by storing energy during

off-peak hours with reduced cost [8]–[12]. Details on the applications of energy storage technologies have been investigated in [13]–[15]. The poor life cycle of batteries has been identified as the key barrier of ESSs that impedes the development of the microgrid (MG). To address this limitation, many researchers have recommended hybrid energy storage systems (HESSs) that aim to improve the life expectancy of batteries [16].

The MG concept is proposed by the Consortium for Electric Reliability Technology Solutions (CERTS) [12]. CERTS can be defined as a localized entity that consists of distributed energy resources (DERs) and controllable thermal and electrical loads. These loads are connected to the upstream grid for power generation using photovoltaic (PV) panels, wind

plants, fuel cells, diesel generators, and microturbines with a storage device (e.g., batteries or supercapacitors (SCs)) [17]. From the utility perspective, MG can be treated as a controlled cell of the power system. From the customer viewpoint, MG can be designed to meet their requirements of reliability, reduced feeder losses, improved efficiency, voltage sag minimization, or continuous power supply [18].

MG with ESS has become a promising component for future smart grid deployment [19]–[21]. However, due to the intermittent nature of renewable energy resources and fluctuating load profiles, the power supply in MG sometimes fails to mitigate the load demands and causes system frequency fluctuation [17], [22]. Therefore, fluctuating renewable energy sources must be smoothed with storage systems to provide high-power quality [23], [24].

MG has flexible operating characteristics in grid-connected and islanded modes and thus can improve grid efficiency and security [25], [26]. In the grid-connected mode of operation, MGs can maintain stable system frequency by exchanging power with a main grid [27]. However, in remote islands, MGs are designed as off-grid systems [28] where the primary frequency control is critical [22]. Fig. 1 illustrates the structure of MG, where PV panels provide energy and a battery energy storage device (BESS) balances the demand for and supply of energy [25].

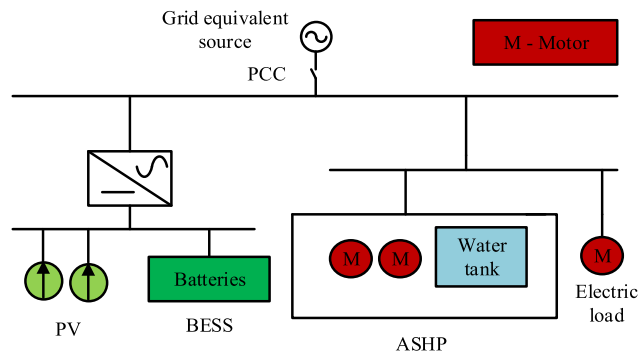

FIGURE 1. Structure of MG [25].

MG connects to the power grid through the point of common coupling (PCC). Given the increased MG installations, distribution systems pose significant changes in characteristics compared with the present distribution system. Therefore, suitable control strategies must be adopted to manage these differences and improve overall efficiency [26].

Many important considerations exist for the energy storage system in MGs. Efficient management of ESS, power electronic interfaces, charging and discharging, conversion mechanism of power, reliability, and protection from dangers are the major issues for the development of the energy storage system in MG applications. Fig. 2 describes the impact of an energy storage system in a power system network [15].

ESS can be applied for energy arbitrage [29], peak shaving [30], load flowing [31], spinning reserve [32], voltage support [33], black start [33], [34], frequency regulation [24], power quality [35], [36], power reliability [37], renewable

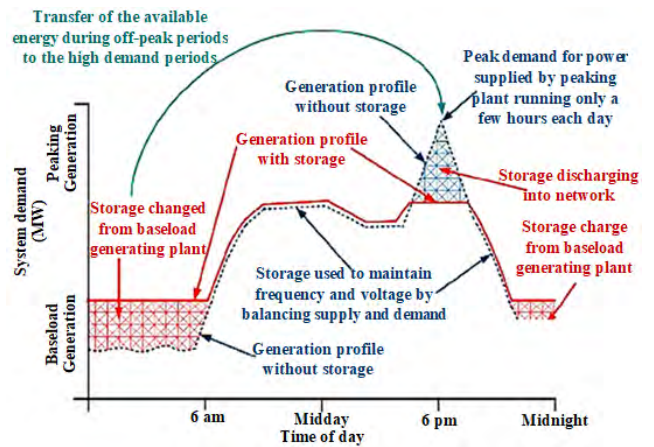

FIGURE 2. Load demand profile with energy storage system [15].

energy systems (REs) shifting [38], [39], smoothing and firming [39], transmission and distribution upgrade deferral [40], congestion relief [41], and off-grid service [38], [41], as shown in Fig. 3 [42].

The selection and management of energy storage systems and energy resources significantly reduce the anomalies in a power system network. The objective of this review is to present the current status of ESSs, evaluate issues and barriers, and provide selected recommendations for further development by focusing on the environment and safety issues. This study discusses various existing energy storage devices, which include their operations and characteristics for efficient MG use. Thus, the key contribution of this study is the comprehensive analysis of selecting future ESSs to attain the sustainable development of MGs. Therefore, this review provides significant information for implementing ESS in MG applications and improving the present technology.

## II. OVERVIEW OF ENERGY STORAGE SYSTEM

ESS configurations, their classifications, and structures are illustrated in the following subsections.

### A. ENERGY STORAGE SYSTEM CONFIGURATION

Typically aggregated and distributed ESS are the two basic configurations of ESS technology for MG applications, as depicted in Fig. 4. For the aggregated system, the amount of power flow from DERs to PCC bus remains at a constant value. Moreover, the total capacity of this ESS can be applied to assuage power flow fluctuations [43]. If the capacity of an energy storage device increases, the cost also increases. Manufacturing and controlling large ESS are difficult. Thus, small-scale and distributed energy storage devices can be used to attain the reliable and effective power regulation. ESS devices in distributed storage configurations are directly connected to specific distributive sources with numerous interfaces. However, controlling power flow is the main challenge faced by the distributed system. Moreover, the storage process still suffers losses through power electronic interfaces for distributed resources and ESS [12].

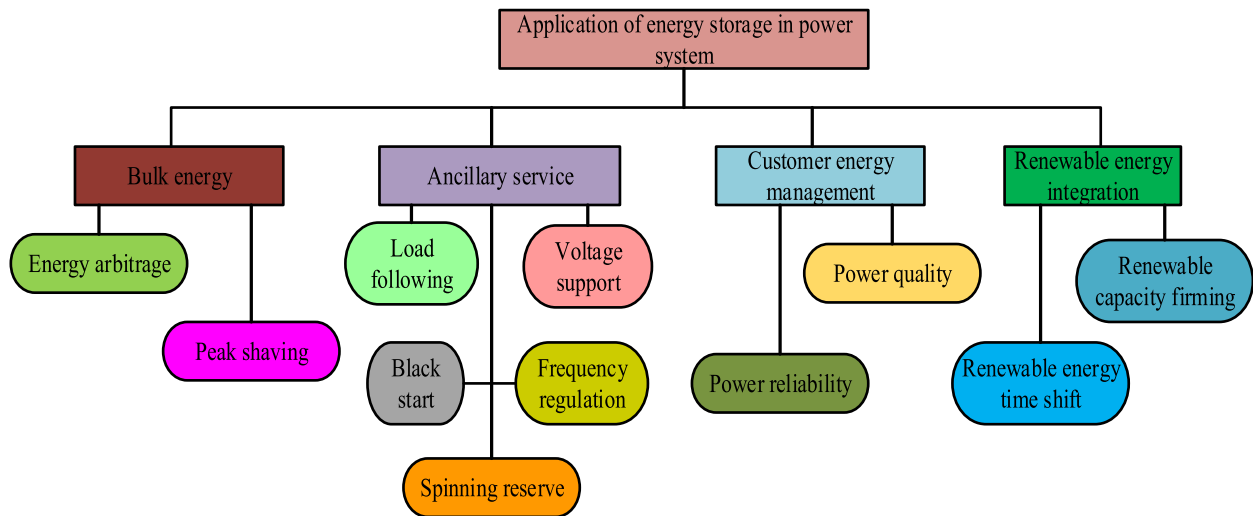

FIGURE 3. Application overview of energy storage system [42].

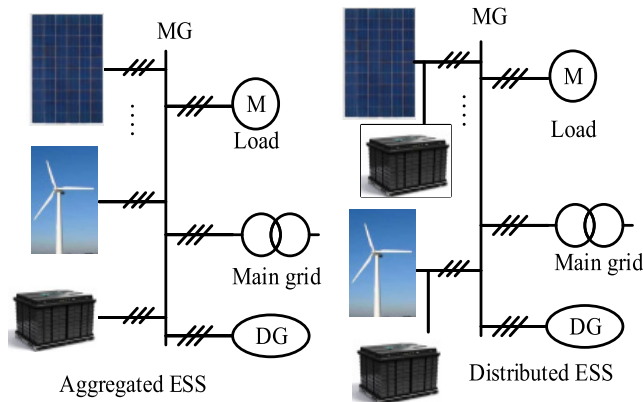

FIGURE 4. Typical ESS configurations [12].

**B. CLASSIFICATION OF ENERGY STORAGE SYSTEM**

ESS is classified based on the usage of energy in a specific form. ESS can be categorized as a mechanical, electrochemical, chemical, electrical, thermal, and hybrid energy storage system. Moreover, these systems can further be classified depending on the process of formations and materials used. Fig. 5 presents the details on the classification of ESS [44]. Batteries [45], compressed air energy storage (CAES) [46], flywheel energy storage (FES) [47], SCs [16], [48], superconducting magnetic energy storage (SMES) [49], hydrogen storage [50], and hybrid energy storages (HESs) [44], [51], [52] are the most frequently used storage technologies for MG applications.

**C. STRUCTURES OF ESS**

Energy can be stored by transforming electrical energy into another form such as chemical or mechanical energy [42]. Moreover, storage systems can be categorized into three parts: central storage, power transformation stage, and control stage. In central storage, energy is stored after conversion,

and power transformation acts as an interface between the central storage and the power system with bidirectional transfer. In the control stage, the level of charge or discharge of the stored energy is determined by the use of sensors and other measuring devices. Energy storage devices are not the ideal source of energy. Thus, they encounter losses at every step of the storing process [42]. The energy output and energy loss of the devices can be formulated as

$$E_{generate} - \Delta E_{loss} = E_{out} \text{ and} \tag{1}$$

$$\Delta E_{loss} = \Delta E_{ch} + \Delta E_{st} + \Delta E_{disch}. \tag{2}$$

The total energy storage efficiency can be written as

$$\eta_{st}^{total} = \frac{E_{out}}{E_{generate}} = \eta_{ch} \times \eta_{st} \times \eta_{disch}, \tag{3}$$

where  $\eta_{ch} = \frac{E_{st}}{E_{ch}}$ ,  $\eta_{st} = \frac{E_{st}^*}{E_{st}}$ , and  $\eta_{disch} = \frac{E_{st}^*}{E_{disch}}$ .  $\eta_{ch}$ ,  $\eta_{st}(t)$ , and  $\eta_{disch}$  are the efficiency of the charge, store, and discharge periods, respectively.  $\Delta E_{loss}$  is the total energy loss, whereas  $\Delta E_{st}$ ,  $\Delta E_{ch}$ , and  $\Delta E_{disch}$  are the energy loss during storage, charge, and discharge periods, respectively.  $E_{st}$  denotes the stored energy in the central part, and  $E_{st}^*$  is the existing energy from the same part.  $E_{generate}$ ,  $E_{out}$ ,  $E_{ch}$ , and  $E_{disch}$  are the generated, output, charging, and discharging energy, respectively.

**III. TYPES OF ENERGY STORAGE SYSTEMS**

**A. MECHANICAL STORAGE SYSTEMS**

Mechanical energy storage systems (MSS) are advantageous because they can operate flexibly to convert and store energy from sources [52]. Moreover, they can deliver the stored power when required for mechanical work [53]. Based on the working principle, MSS can be classified as pressurized gas, forced spring, kinetic energy, and potential energy. However, from a technological point of view, mechanical storage systems consist of three techniques: flywheel, pumped hydro

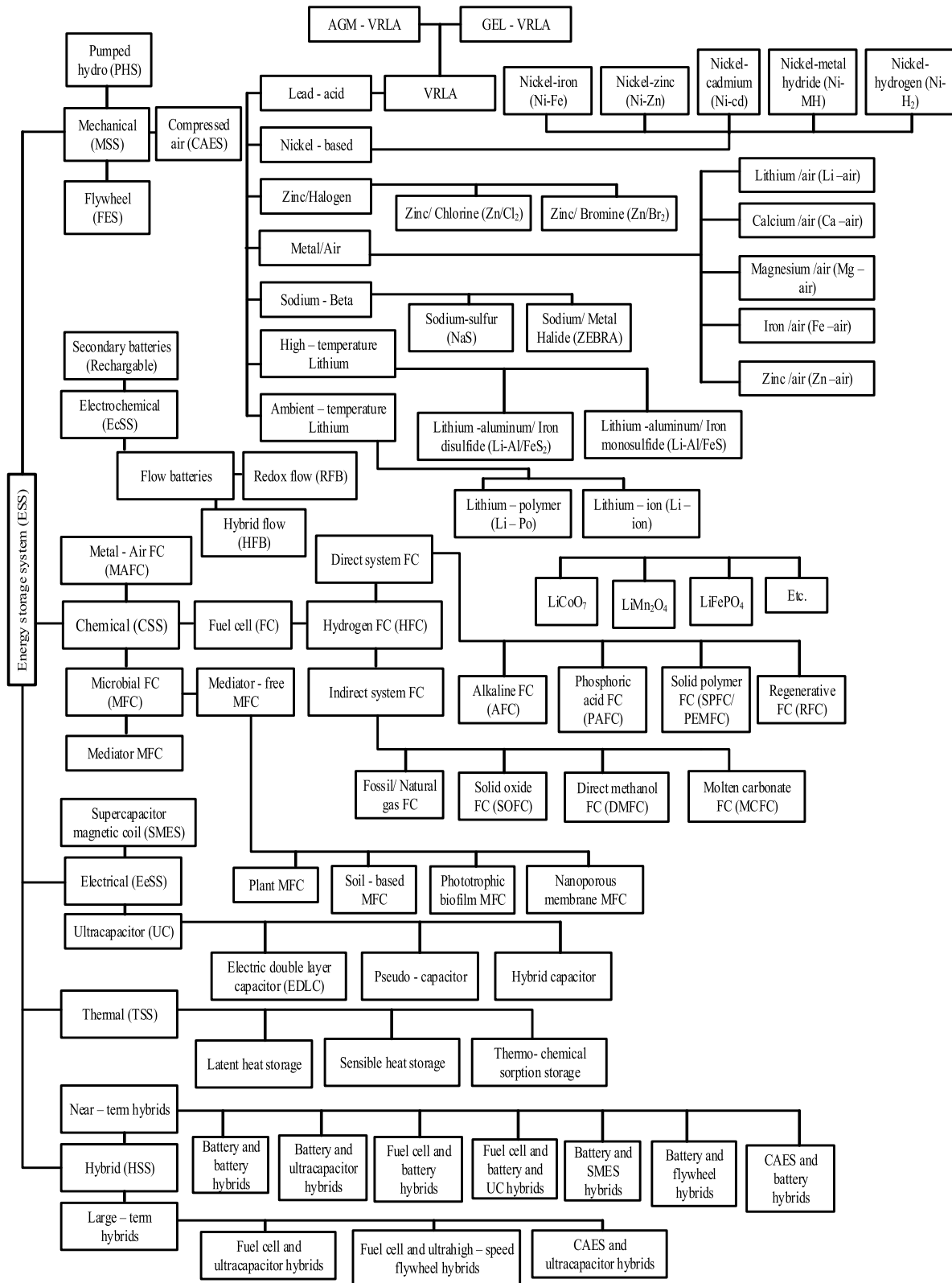

FIGURE 5. Detailed classifications of energy storage technologies based on formation of energy and materials [44].

storage, and compressed-air energy technologies. Among the three systems, pumped hydro-storage systems (PHS) contribute the most in the world electricity storage capacity

with their long life cycle. Although bulk energy systems still rely on PHS, PHS has severe drawbacks, such as high capital cost, negative environmental impact, and reduced

geological implementation. Thus, the future improvement of PHS is limited [54]–[57]. Details on other technologies, such as flywheel energy storage systems (FESS), CAES, and gravity energy storage systems (GES) are discussed as follows.

1) FLYWHEEL ENERGY STORAGE SYSTEMS

Flywheel, as the main component of most modern high-speed FESS, is a massive rotating cylinder (disk) that is supported on a stator by magnetically levitated bearings [58]. FESS can be characterized into two basic categories: high-speed and low-speed FESS [59]. Flywheels with speed of under 10,000 rpm are considered as low-speed flywheels, which are more popular in industries [60]. The principal structures of a flywheel system and a hollow cylinder flywheel are shown in Fig. 6 [61]. A flywheel can be used for the smooth running of machines and can mechanically store kinetic energy from the rotor mass spinning at high speeds [59], [62]. The stored kinetic energy in FESS is related to speed and inertia. Low-speed FESS contains a steel disk with high inertia and low speed. On the other hand, high-speed FESS has a composite disk with relatively lower inertia and high speed. As the rotating speed of rotor increases, stored energy also increases proportionally, and the stored energy varies in a square with angular momentum. This stored energy can be used further by decelerating rotor torque (discharge mode) and returning the kinetic energy to the electrical motor, which acts as a generator [52], [62]. The efficiencies of flywheel storage devices ranges from 90% to 95%, whereas rated power ranges from 0 MW to 50 MW [63]–[65]. A typical comparison can be developed between these two types of flywheels, and the differences are summarized in Table 1 [66].

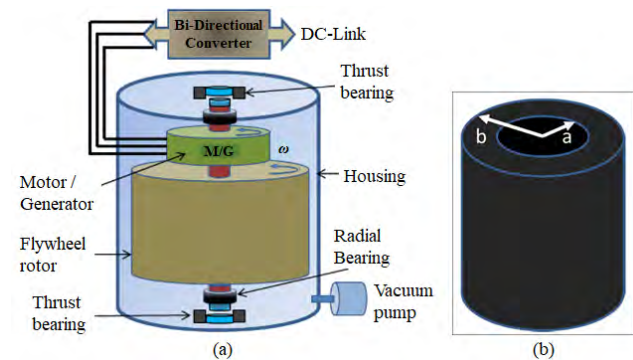

FIGURE 6. (a) Principal structure of flywheel energy storage system and (b) hollow cylinder flywheel [61].

Moreover, flywheels can be added in parallel to increase the specific energy. The energy concentration varies from low (5 W h/kg) speed to high (100 W h/kg) speed [55], [59]. In case of sudden deficiency in the generation of electricity from renewable sources, such as solar or wind sources, a storage system similar to FESS can perform better than BESS [55].

FESS stores the electrical energy in the rotating mass. Therefore, the equation for the total energy stored in the

TABLE 1. Typical comparison between low-speed and high-speed flywheels [66].

Particulars	Low-speed flywheel storage system	High-speed flywheel storage system
Disk material	Steel	Composite
Types of machines used	Induction machine, permanent synchronous machine (PMSM), and switched reluctance machine (SRM)	PMSM and SRM
Bearing types	Mechanical or mixed mode (magnetic and mechanical)	Magnetic bearing
Application field	Power improvement	quality Traction and aerospace industry
Cost	Low	High

flywheel can be derived as

$$E_{fw} = \frac{1}{2}J \times \omega^2 \text{ and } J = \frac{1}{2}m \times r^2 = \frac{1}{2}\rho \times h \times \Pi \times r^4, \tag{4}$$

where  $E_{fw}$  is the stored energy in the flywheel;  $J$  is the moment of inertia;  $\omega$ ,  $m$ ,  $r$ ,  $\rho$ , and  $h$  are the angular velocity, mass, radius, mass density, and length of the flywheel, respectively. Therefore, Eq. (4) implies that flywheel speed or its inertia can be increased to raise the volume of the stored energy. Shape and mass determine the inertia of the flywheel. For the hollow cylinder flywheel, as shown in Fig. 7(b), with outer radius  $b$  and inner radius  $a$ , the moment of inertia can be defined by

$$J = \frac{1}{2}m \times r^2 = \frac{1}{2} \times m \times (b^2 - a^2) = \frac{1}{2}\rho \times h \times \Pi \times (b^4 - a^4). \tag{5}$$

According to Reference [58], flywheel energy storage technology has been applied in various sectors due to its unique characteristics, such as high power density, environment friendliness, high efficiency, low maintenance cost, and long cycle period. Reference [55] shows that the maintenance cost of FESS is low (\$19/kW-year) although the capital cost is high (\$5000/kWh). The main advantage of FESS is that it requires no temperature control equipment [47]. Fig. 7 describes the application of FESS in MG.

In this technology, a power converter acts as an electrical interface. In Reference [67], an improved mechanism of bidirectional converter topology was developed using zero voltage transition and zero current transition techniques. This study showed that the extent of power saved using the proposed topology was 2.5%–3.5%. Thus, an advanced controller can be adopted to optimize the charging and discharging characteristics of this storage system, which significantly improves energy saving management.

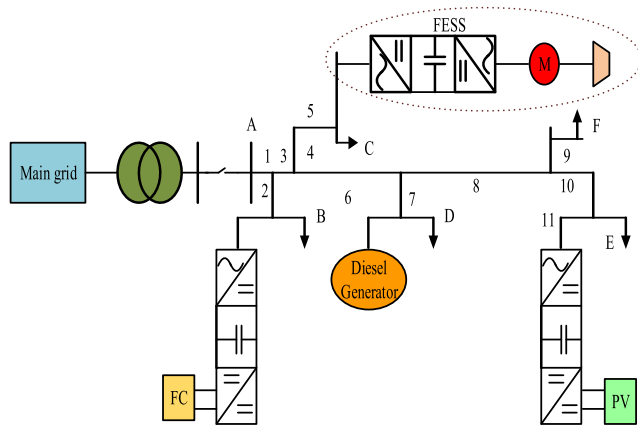

FIGURE 7. FESS implementation in MG [47].

Although FESS has several advantages, it has the drawbacks of high initial cost and high rates of self-discharge (3%–20% per hour) [68]. Moreover, the high power density and low energy density confines the application of FESS. Therefore, the cost and discharge rate are reduced with the high-speed flywheel and the advancement of technology. Overcoming these limitations, FESS becomes highly reliable and sustainable with the reduction of CO<sub>2</sub> emission and improved power system stability.

2) COMPRESSED-AIR ENERGY STORAGE SYSTEMS

CAES generally stores the pressure energy with the compression of gas (usually air) into the reservoir. A turbine is used for the expansion of the compressed gas, which can be transformed into mechanical energy [69]. Fig. 8 illustrates the simplified schematic of a CAES plant [55]. During low power demand, excess power drives a reversible motor or a generator unit, which in turn runs a chain of compressors to inject the air into the storage unit. This storage unit can be in the form of an underground cavern or an overground reservoir. However, during low power generation for the load demand,

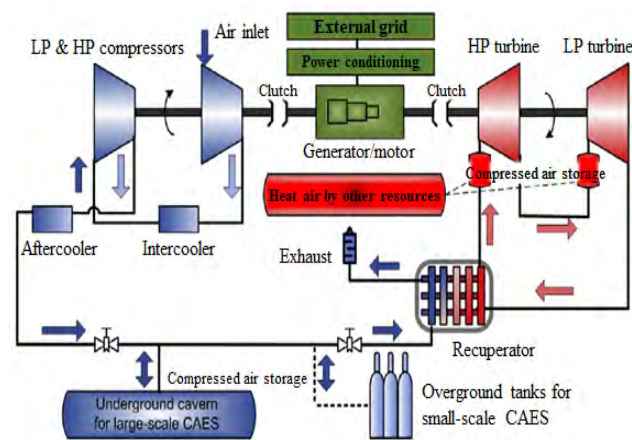

FIGURE 8. Simplified diagram of compressed air storage system [55].

the stored compressed air is released and then heated by the heat source. The compressed air energy is later transferred to the turbine. A recuperator unit is used here to recycle the waste heat energy, which further reduces fuel consumption and cycle efficiency. A comprehensive review of CAES until 1985 was investigated in [70].

The first utility-scale CAES plant in the world is the Huntorf power plant, which was developed with two salt domes as the underground storage caverns (300000 m<sup>3</sup> at 50 °C and 46–66 bar). The power rating of this plant is 290 MW. This plant was designed to operate at 8 hours daily life cycle by charging with compressed air. Moreover, it can operate for 2 hours with full power rating [71], [72]. An advanced plant named MacIntosh plant was developed in 1991 in Alabama. Its capacity is 110 MW; the plant can operate at a cycle of 26 hours with full power [71], [73]. Fig. 9 shows the simplified structure of the MacIntosh plant [74]. The plant consistently shows good performance with a range of 91.2%–99.5% starting and running reliabilities [75].

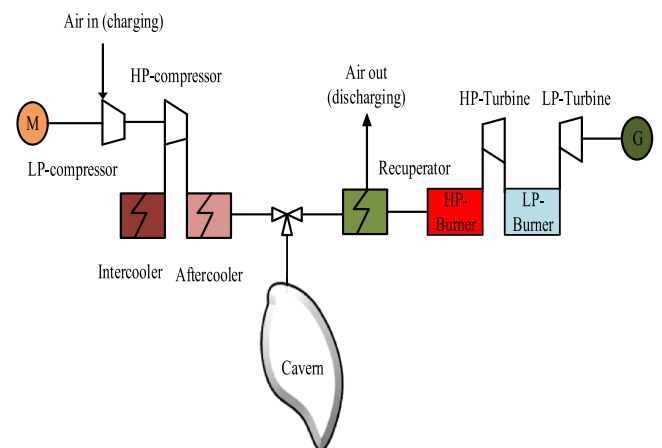

FIGURE 9. Thermo-mechanical concepts for bulk energy storage (MacIntosh plant) [74].

The CAES system can be built for small- to large-scale power capacity. However, it is suitable for a large-scale unit that involves grid applications for load shifting, peak shaving, voltage, and frequency control [55]. The response time of CAES is high. CAES can smoothen the power output of off- and on-shore wind plants. Thus, CAES has attracted the attention of the academic and industrial sectors [76]. The recent development in the field of CAES is the application of supercritical compressed air or compressed CO<sub>2</sub>, which has increased the efficiency of the plant [76], [77] by overcoming the problems of conventional CAES. A major challenge to implement the large-scale CAES technology is selecting the suitable geographical positions with underground natural caves [58]. To address this issue, advanced adiabatic CAES plant was proposed, which also faces a problem of low discharge efficiency. A combined cooling, heating, and power system was investigated in 2016 to solve these drawbacks [78].

### 3) GRAVITY ENERGY STORAGE SYSTEMS

Pumped hydro and CAES are the widely used storage technologies for large-scale systems. However, given their aforementioned disadvantages, GES has become popular as an alternative to the large-scale system [79]. In [79], the details of GES, such as modeling, system design, sustainability, economic viability, and material selection, have been discussed. GES is a new concept and remains in the process of development. It is a closed system that consists of reversible pump/turbine, generator, piston, and container with a returned pipe. Fig. 10 shows the basic structure of GES.

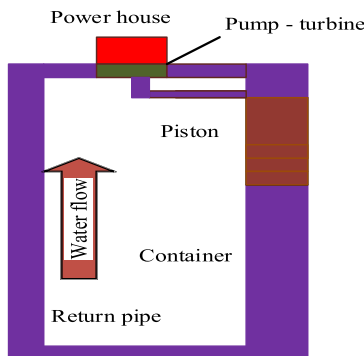

FIGURE 10. Gravity energy storage diagram [80].

When demand is high, the piston pushes the water to flow to the container and is then passed through the return pipe to drive the turbine. The turbine then converts the kinetic energy of water into mechanical energy, which spins the generator to produce electricity. When the demand lowers, the excess energy is supplied to the motor and follows the reverse mechanism. The generated kinetic energy pushes the piston to the top of the container, and the mechanical energy is restored for further use. This GES technology overcomes the limitation of sitting issues, which are a major drawback of PHS [81]. Future research on this technology could be based on the material used, sizing, and capacity with a long life cycle, which encourages the widespread use of GES in MG applications.

### B. ELECTROCHEMICAL STORAGE SYSTEMS

In the electrochemical storage systems (EcSS), chemical energy in the active material is converted into electrical energy [82]. This conversion technique is completed by chemical reaction, and energy is stored as electric current for a specific voltage and time [83]. The level of voltage and current are generated through the series or parallel connections of cells [84]. This is the largest group of energy storage devices investigated by [82]. Conventional rechargeable batteries and flow batteries (FBs) are two techniques that store energy in electrochemical form. However, chemical reaction reduces the life expectancy and energy of battery although minimal maintenance is needed for these batteries [85].

Electrochemical storage devices are available in different sizes, which is the main advantage of this technology [86].

Lead-acid [87], lithium-ion [69], [88], [89], sodium-sulfur (NaS) [12], [32], [42], nickel-cadmium (NiCd) [90], nickel-metal hydride (NiMH) [91], and FBs [8], [69], [88] are examples of this storage system. Some common EcSSs that can be applied in MG are discussed in the following subsections.

#### 1) REDOX FLOW BATTERY STORAGE SYSTEMS

FBs, which are usually called redox flow batteries (RFBs), operate in charged or discharged mode by a (reversible) chemical reaction. The reaction takes place between the electrolytes of the battery. These two electrolytes of RFBs are contained in separate tanks. The tank capacity is directly proportional to the capacity of batteries, and the capacity of battery is influenced by the number of battery cells and materials. Electricity is generated when redox chemical reaction (reduction–oxidation) takes place during operation [92]. RFBs has high efficiency (up to 85%) with a long life cycle. It has high stability and storage capacity with flexible operational characteristics in the electrical system. Thus, RFB becomes beneficial for application in an autonomous and standalone network [93], [94]. A common and mature example of redox flow battery is vanadium redox flow battery (VRFB) [58]. Fig. 11 poses the principal view of vanadium battery [55]. It shows that two liquid electrolytes ( $V^{2+}/V^{3+}$  and  $V^{4+}/V^{5+}$ ) with dissolved metal ions have been pumped to the opposite sides of the battery. Flow battery has only one active element out of the two porous electrodes, anolyte and catholyte. During charging/discharging mode,  $H^+$  is exchanged through the ion separation of the membrane [93]. The chemical reactions are as follows when the cell voltage is approximately 1.4 V [93], [95]:

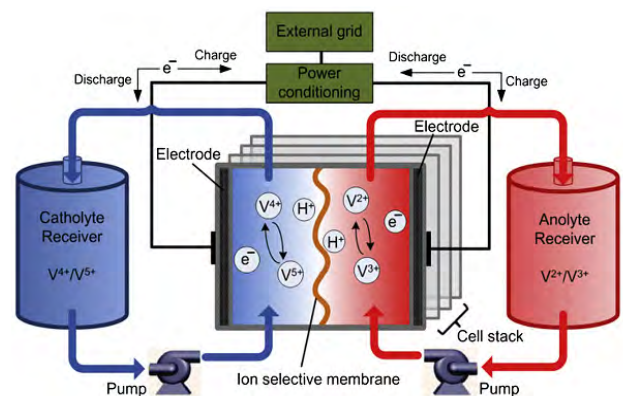
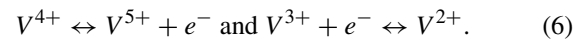

FIGURE 11. Principal view of a vanadium redox flow battery [55].

The main advantages of VRFB are being faster than 0.001 s response characteristics and operating cycles (10,000 to 16,000+) [33], [96]. VRFB has various types of applications. It can support the intermittent nature of renewable sources. VRFB is also useful for power quality improvement in different applications, such as UPS, power security, and load leveling [58], [97]. Several research projects have

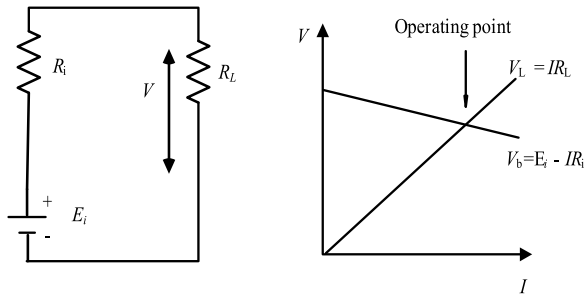

FIGURE 12. Equivalent circuit of a battery and its operating point [68].

been conducted in different parts of the world to develop a large-scale VRFB, which can have achievements after initial small-scale applications. The main disadvantage of RFBs is that their complex structure influences the reliability of the system [98]. Moreover, RFBs are expensive, and external power supply is needed to operate them [99]. Thus, future development is needed to overcome these issues with reduced battery size, improved energy density, and increased calendar cycle.

2) BATTERY ENERGY STORAGE SYSTEMS

BESS is widely applicable for various purposes in all sectors (generation, transmission, and distribution) of electrical power systems and thus provides benefits to consumers [86]. In [100] and [101], the comprehensive review of the storage system of different battery storage technologies, such as lead-acid, lithium-ion, redox flow, NaS, and nickel-cadmium battery has been investigated. The frequency of MG is anticipated to be controlled by BESS technology. A simple equivalent circuit of a battery is presented in Fig. 12 [68]. The operating point is the intersection of the source line.  $V_b$  is the terminal voltage drop, and  $V_L$  is the load line voltage.

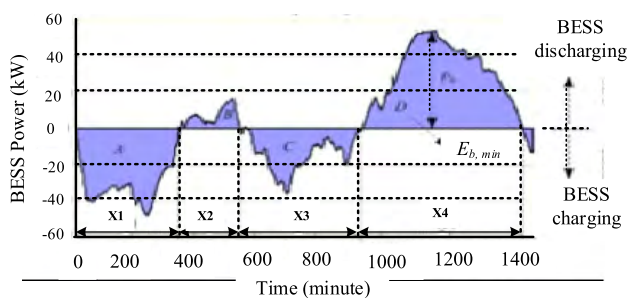

FIGURE 13. Typical BESS power profile that considers one day [102].

Fig. 13 depicts the typical power profile of BESS for one day. The power curve above the horizontal axis (time) denotes the discharging characteristics of battery to regulate the frequency. Power below the time axis depicts the charging state of the cell to maintain the frequency within the reasonable range [102].

Battery capacity is an important determinant in selecting a storage device. The capacity of a battery may be defined as the total quantity of electrical charges that can be delivered

in a single discharge by the cell. The state of charge (SoC) can be described as the ratio of remaining capacity to the nominal capacity. Eq. (7) depicts the variation of SoC ( $dSoC$ ) that depends on time and capacity  $C_i$ .

$$dSoC = \frac{idt}{C_i} \text{ and}$$

$$dSoC = SoC - \int \frac{idt}{C_i}. \tag{7}$$

Different studies reveal that a quasi Z-source inverter is a suitable technique for the parallel operation of the battery. In Reference [103], a quasi Z-source inverter for BESS has been proposed for the application in MG. In this model, the shoot-through duty cycle of the quasi Z-source inverter is applied to share the load current between the batteries operated in the islanded connection scheme. However, in the case of a grid-connected mode, to obtain the independent regulation of current in both battery systems, the proposed model depends on the inverter modulation index and the shoot-through duty cycle. The result of this study proved that microgrid voltage remains balanced in the unbalanced load conditions. Various battery technologies are illustrated in the next subsections.

a: LEAD-ACID STORAGE SYSTEMS

Lead-acid (PbA) battery is the most widely used rechargeable storage with various sizes and designs in different applications [58], [85]. Among all electrolyte batteries, the PbA battery shows high efficiency (70%–80%) and possesses the highest cell voltage [58], [98].

The cathode and anode are made of  $PbO_2$  and Pb, respectively. Sulfuric acid is used as the electrolyte. They are less expensive compared with other battery technologies, such as NiCd and NiMh, and are highly suitable for large-scale MG applications [82], [90]. Other advantages of this technology are that PbA battery provides excellent charge retention and energy density with fast response and long life cycle (5–15 years) [42], [98]. However, traditional PbA battery has a short cycle-lifetime (500–2000 cycles), low specific energy, periodic water maintenance, and premature failure due to sulphation. To overcome the limitations mentioned, advanced PbA batteries have been developed, which possess nine times higher power handling capability and four to ten times increased life cycles [33], [58].

PbA batteries can be categorized into flooded and valve-regulated (VRLA) batteries. The latter has become increasingly popular due to its high specific power, relatively low installation and maintenance cost, and rapid charging characteristics [104]. VRLA includes the adsorbed glass material (AGM) and GEL. AGM batteries have compact volume and recombines hydrogen and oxygen to form the water in the charging mode; thus, water usage is limited [105]. However, GEL batteries need to have the controlled mechanism for charging. The main disadvantage of this GEL battery is that inside the GEL electrolyte, gas bubbles may be produced, which could damage the battery



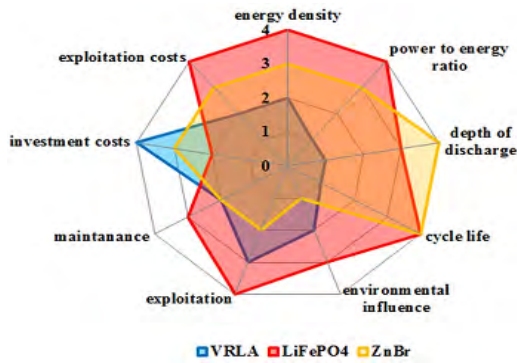

FIGURE 14. Characteristics of selected energy storage devices at a glance (1-worst and 4-best in each category) [107].

permanently [105], [106]. In [107], a comparative analysis of selected energy storage devices is provided, as depicted in Fig. 14. It proves that VRLA can be developed in all the categories mentioned in the figure and can be a good choice for researchers and industrialists in the future.

The development of lead-acid batteries has focused on the innovative materials for improvement in the performance and implementation of PbA for applications in the integrated wind, PV power, and automobile sectors. Reference [108] investigated an islanded renewable energy microgrid emulator with PbA battery. The proposed method can be applied in different MG configurations using the combinations of available generating units.

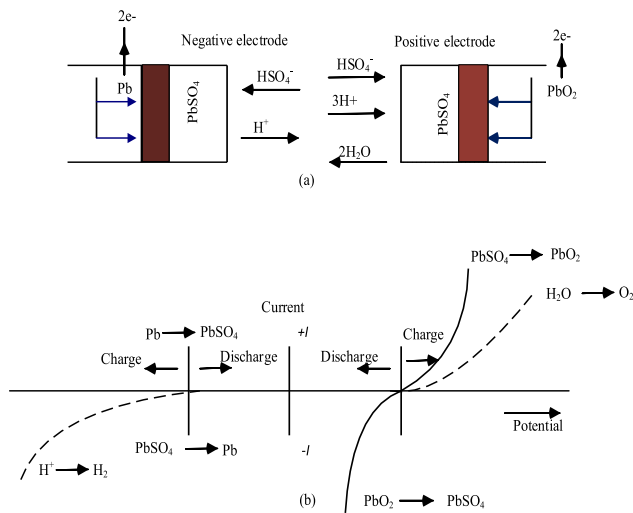
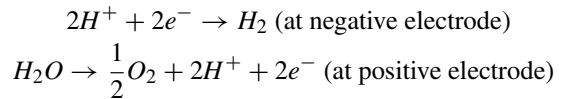
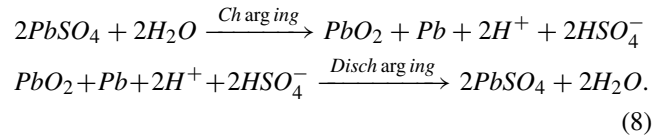

FIGURE 15. (a) Charging and discharging operation of a lead-acid battery and (b) schematic representation of the current potential traits of both electrodes [109].

Fig. 15(a) describes the charging and discharging operation of lead-acid battery chemistry. During the discharge phenomena,  $HSO_4^-$  ions pass through the negative electrode and form a chemical reaction with  $Pb$  to produce  $PbSO_4$  and  $H^+$  ions. During charging,  $PbSO_4$  is converted to  $Pb$  or  $PbO_2$ . Hydrogen and oxygen are generated at the negative and

positive electrode, respectively. Fig. 15(b) depicts the current-potential characteristics of both electrodes. The overall electrochemical reactions that take place during charging and discharging in the PbA battery can be deduced as follows [109], [110]:



Overall,  $H_2O \rightarrow H_2 + \frac{1}{2}O_2$ .

### b: LITHIUM-ION (LI-ION) STORAGE SYSTEMS

Although lithium-ion batteries were first commercialized in the 1990s, this energy storage technology has become the fastest growing technology in recent years [33], [111]. A Li-ion storage device can store energy at the megawatt scale. The significant advancement of this technology in increasing the levels of energy storage capacity is due to the characteristics of high efficiency (>90%), high energy density, rapid response time (in milliseconds), and attractive self-discharge rate (5% per month) [92], [112]. A schematic of the Li-ion battery along with the charging and discharging method is presented in Fig. 16 [113], [114]. The cathode and anode are made from lithium metal oxide ( $LiCoO_2$ ) and graphite carbon cell, respectively. During the charging period, Li-ion passes from cathode to anode. The process is reversed in the case of the discharge period. The electrolyte used here can be formed using an organic solvent with dissolved lithium salt or solid polymer [55]. Complete electrochemical reaction that takes place during the operation of Li-ion battery can be written as follows:

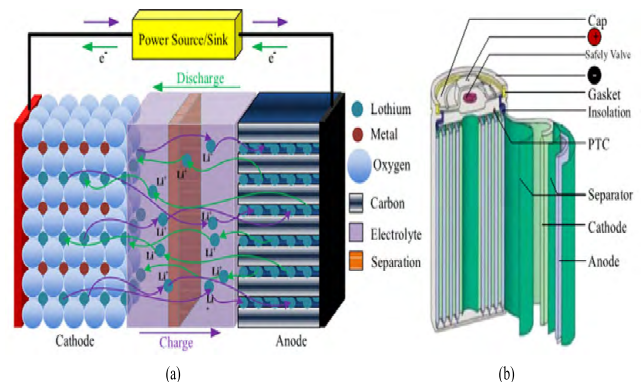
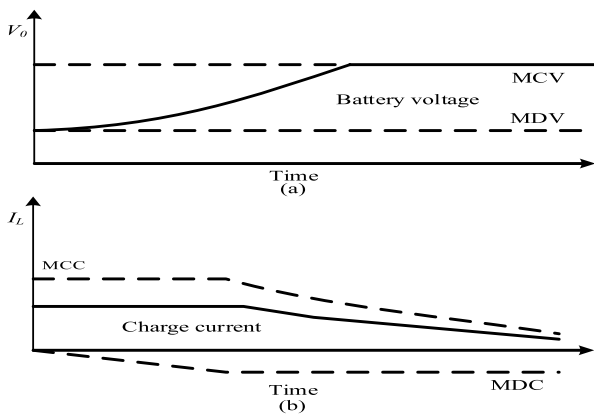

FIGURE 16. (a) Charging and discharging method of Li-ion battery and (b) schematic of Li-ion battery [113], [114].

Fig. 17 describes the typical charge profile for the medium power Li-ion battery. In [115], a medium-power Li-ion battery was examined for MG integration. The evaluation of

**TABLE 2. Characteristics of electrochemical energy storage technologies in modern grids [42].**

Technologies	Name	Capacity (MWh)	Power (MW)	Response time	Discharge time	Life time (Years)	Efficiency (%)	Advantage	Disadvantage
Electrochemical	Lead-acid	0.25 – 50	≤ 100		≤ 4h	≤ 20	≤ 85	Highly recyclable and low-cost	Heavy, poor energy density
	Lithium-ion	0.25 – 25	≤ 100		≤ 1h	≤ 15	≤ 90	High storage capacity and long life cycle	
	NaS	≤ 300	≤ 50	millisecond	≤ 6h	≤ 15	≤ 80	High storage capacity and low cost	Works only when Na and S are liquid (290–390 °C)
	Vanadium Redox	≤ 250	≤ 50	≤ 10 min	≤ 8h	≤ 10	≤ 80	Possible to use in various renewable sources	



**FIGURE 17. Sketch of typical charging characteristics for medium-power Li-ion battery [115].**

the proposed method was considered in the following scenarios, such as black start operation, the rejection capability of positive and negative current disturbance during voltage regulation, and low voltage fault. The experimental result reveals that the proposed method exhibits an acceptable performance under typical MG scenarios. To prolong the battery life, the current level must maintain the range of maximum dynamic charge current and maximum dynamic discharge current. Moreover, the battery voltage should also maintain the range of maximum charge voltage and maximum discharge voltage. The disadvantages of the Li-ion battery are its cycle depth of discharge (DoD) and high cost. However, the cost of the Li-ion cell is expected to decrease with large-scale production. Table 2 illustrates the features of different energy storage devices and helps in the selection of Li-ion battery as an energy storage device given its improved performance [42].

Li-ion batteries are designed for high-temperature applications. The design of batteries depends on new and improved

chemistries (e.g.,  $\text{LiFePO}_4$  and  $\text{Li}_4\text{Ti}_5\text{O}_{12}$ ). Thus, these batteries are characterized by high gravimetric and volumetric energy density (75–200 Wh/Kg and 200–500 Wh/L). It also shows improved efficiency (90%–95%), high power capability (nine times with respect to nominal power), extended lifetime (of approximately 20 years), prolonged cycle operation (8000 full cycles), and a wide temperature range (–20 °C to 55 °C [33], [58], [96]). Thus, this technology has become increasingly popular due to its small size, light weight, and potential.

MGs are small power systems that operate independently from the distribution grid, and Li-ion batteries can be the best-suited storage technology for the islanded operation of MG [116]. Moreover, a concrete idea for a lithium-iron-phosphate ( $\text{LiFePO}_4$ ) battery is discussed in [117]. However, Reference [118] proposed that a lithium-sulfur battery can be a good alternative due to its high specific energy, reliability, comparatively low cost, and reduced environmental hazard. Recently, Tesla has implemented the world’s largest storage technology with Li-ion battery. The capacity of this Hornsdale wind plant is 100 MW. Thus, an advanced Li-ion battery can be developed by incorporating all these characteristics, which show acceptable performance with good efficiency, large storage facility, long calendar life, and low discharge rate.

*c: SODIUM-SULFUR (NaS) STORAGE SYSTEMS*

NaS battery comprises of molten electrodes (both sodium and sulfur) and non-aqueous beta alumina electrolyte. Sodium is used as the negative electrode and sulfur is treated as the positive electrode. Fig. 18 shows the charge and discharge reactions of the NaS battery. During the discharging period, sodium ( $\text{Na}$ ) is oxidized at the  $\text{Na}$ -beta interface to produce sodium ion ( $\text{Na}^+$ ) when passing through

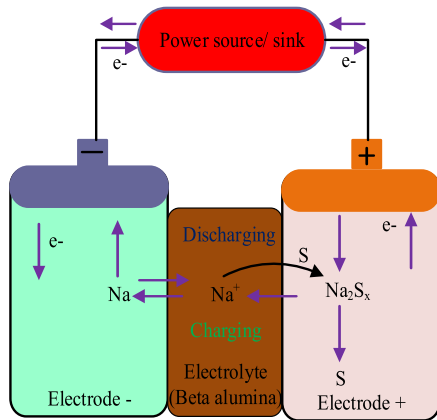
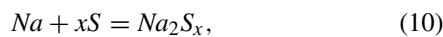

FIGURE 18. Charging and discharging phenomena of NaS battery [58], [119].

the electrolyte. This ion is combined with sulfur to form sodium polysulfide ( $Na_2S_x$ ). The ion is also observed to produce the desired output voltage. Electrons flow through the external circuit. Reverse mechanism occurs when the battery is recharged [33], [98], [113]. The overall electrochemical reaction in the NaS battery can be written as



where the value of x should be within 3–5.

This technology is widely applicable for load leveling, voltage sag minimization, and stabilizing renewable energy power generation [119]. However, as mentioned, this type of electrochemical energy storage device needs to operate at high temperature (350 °C/ 623 K) to maintain high reactivity and ensure that sodium and sulfur turn into liquid [32], [59]. This mechanism leads to difficulties in using the NaS battery in various applications given that the cost increases due to its implementation [90]. However, with the advancement of technologies since 1980 and applying the modular fabrication process, the energy density of this battery becomes much higher (four times from lead-acid battery), and cost becomes lower compared with other storage devices. Moreover, research is ongoing to control the limit of temperature and maintain high energy density, as presented in [120]. As a potential device to implement in MG, it shows high efficiency, a long cycle period up to 15 years, and fast response (in millisecond) during full charging and discharging operation. Thus, countries such as Japan and China are investing in large-scale industrial applications of this technology [121]. The application of NaS battery in some parts of the world is presented in Table 3 [119], [122].

### C. CHEMICAL STORAGE SYSTEMS

A chemical energy storage (CES) system is suitable for storing a significant amount of energy for a long duration. In the CES system, energy is stored in the chemical bonds of atoms and molecules, which can be released through electron transfer reactions to produce electricity directly. The most widely

TABLE 3. Application of selected NaS battery with energy storage facilities [119], [122].

Name of project	Power rating of plant	Particulars
Kawasaki EES Testing Facility, Japan	0.05 MW	First large-scale application of NaS battery
Long Island Bus's BES System, USA	1 MW/ 7 MW h	Refueling vehicles in a particular route
Rokkasho Wind Farm ES Project, Japan	34 MW/ 244.8 MW h	Power fluctuation control
Saint Andre, La Reunion, France	1 MW	Wind energy storage
Graciosa Island, Younicos, Germany	3 MW/ 18 MW h	Wind and solar energy storage
Abu Dhabi Island, UAE	40 MW	Load leveling

used chemical fuels in electricity generation and energy transportation system are coal, gasoline, diesel, propane, ethanol, hydrogen, and liquefied petroleum gas (LPG). The CES system focuses on hydrogen technology because of its remarkable feature as fuel and its ability to store a large amount of electrical energy [8]. In the next subsection, the details of hydrogen storage systems are illustrated.

#### 1) HYDROGEN FUEL CELL STORAGE SYSTEMS

Hydrogen fuel cell (HFC) fascinates academics and industrialists because it is suitable for emission-free electricity generation and can be applicable in distributed generation to the automobile industry. When burned, HFC releases water vapor only into the environment. HFC burns faster and contains considerable chemical energy per mass (142 MJ) compared with other hydrocarbon fuels. HFC has high energy density by weight and low energy density by volume. The environmental impact of hydrogen storage is desirable, which leads governments across the globe to enhance the prospects of the hydrogen economy [123]. The per-unit cost of electricity generation for this technology has decreased given the available raw material resources. Fig. 19 shows the schematic of HFC.

According to the figure, when hydrogen fuel reaches the surface of the electrode, it dissociates into  $H^+$  and  $e^-$ .  $H^+$  moves through the electrolyte and reaches the oxygen electrode. The electron starts to travel through the external circuit and provides power to the load. Hydrogen ions, oxygen, and electrons are combined to form water. A power electrolyzer can be used to dissociate the water molecule into hydrogen and oxygen in the regenerative closed-loop process and thus produce electricity. This process is repeated until the required amount of electricity is achieved [124]. Three types of electrolysis technology are available: alkaline, polymer electrolyte membrane (PEM),

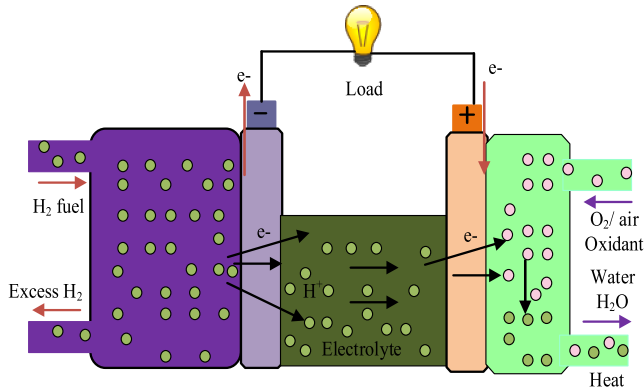
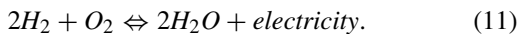

FIGURE 19. Mechanism of HFC [44].

and high-temperature solid oxide electrolysis [125]. Among these alternatives, the alkaline technique is highly suitable because of its maturity and low cost (\$525/kW). PEM has high power density albeit it is costly due to high material cost [126]. The efficiency of alkaline and PEM ranges from 62% to 82%, which depends on the production that varies from 4.5–7.5 kWh/Nm<sup>3</sup>. However, solid oxide electrolysis shows voltage efficiency ranges from 81% to 86% although it has the challenge of overcoming problems from corrosion, seals, and thermal cycling [125], [127].

The overall chemical reaction in an HFC can be deduced as follows:



The hydrogen required can be produced on-site or purchased from another external source. On-site production is cheaper than purchasing hydrogen from another source. Hydrogen production from various sources, such as natural gas, coal, gasoline, diesel fuel, water electrolysis, and biomass, was investigated in [128]. Reference [50] studied the application of hydrogen storage in a low-voltage MG, and the utilization of HFC was performed well. The present study proposes that HFC can have significant potential to assist aggregators and MG effectively if a wide range of renewable sources are used. This storage technique can be categorized into two groups. One is physical (in gas or liquid phase) and another is a material-based storage system. However, research shows that a physical system requires high pressure, whereas material-based hydrogen, such as metal hydride, needs high pressure and temperature for hydride formation and hydrogen release. These are the main limitations of this technology. Therefore, searching for an ideal material to solve these limitations remains a challenge for the application of this technology. For load-shifting applications, hydrogen storage technology is preferred, but this technique is costly and its efficiency is the most critical criteria to develop this technology [92].

#### D. ELECTRICAL STORAGE SYSTEMS

Electrical energy storage system (EESS) may be defined as the capacity of storing electrical energy to produce electricity

and supplying it to the load for use when necessary. Energy can be stored by modifying the electrical or magnetic fields with the help of capacitors or superconducting magnets [92]. The current power network system faces the challenge of integrating the transmission and distribution system with renewable energy sources. Therefore, EESS has been treated as a suitable technology to mitigate this issue due to the multiple attractive features in the system network. These features may help in operating the power system network, load balancing, improving the power quality, supporting the MG, and reducing the necessity of importing electrical energy in the peak demand period [55]. Ultracapacitors (UCs) and SMES systems are examples of EESS [58]. They can be used as short-term storage devices in case of high flow current given that the capacity of the conventional capacitor is limited. Therefore, a supercapacitor with high storage capacity may replace the normal capacitor, which has high capacitance. SMES are preferred at the exit of the power plants to stabilize the output or in the industrial sector, where peak energy consumption must be accommodated [52]. The details of these two storage systems along with their recent development are described extensively in the following subsections.

#### 1) SUPERCAPACITOR STORAGE SYSTEMS

SCs, also called UCs or electric double layer capacitors (EDLCs), can be defined as storage devices that can store electrical energy between two conducting electrodes. This technology has no chemical reactions. It has become the alternative to a classical capacitor used in different electronic applications and general batteries. This technology has the characteristics of high power density and high peak power output; the long calendar life cycle can be recharged and discharged up to millions of times compared with the conventional battery [129]. The energy density of SC has been increased due to the use of a high-surface area material, such as activated carbon. In the applications of the power system, such as communication and spacecraft technology, pulse load may exist. This type of load may cause severe power and thermal disturbances in MG applications; this is the main reason for introducing the SC, which has a fast response in power leveling and power balancing installations with the proper control system to overcome these problems [69], [130], [131]. Fig. 20 illustrates the principal structure of a supercapacitor.

The capacitance of SC is not constant; instead, it varies with the change of the voltage, which depends on the current demand and supply from SC. Therefore, the charge concentration also varies. The variation in charge separation distance (i.e., Debye length,  $d_c$ ), which concerns the level of the electrolyte ( $C_e$ ) can be deduced as

$$d_c = \sqrt{\frac{\epsilon_r \epsilon_o RT}{2F^2 C_e}}. \quad (12)$$

Fig. 21 discusses the equivalent model of SC, where it is composed of two parallel capacitors: constant capacitance ( $C_o$ ) and voltage-dependent capacitance ( $k.v_c$ ).

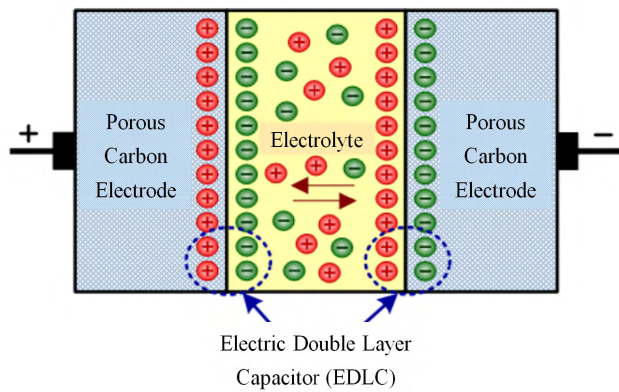

FIGURE 20. Schematic view of SC or UC or EDLC [62].

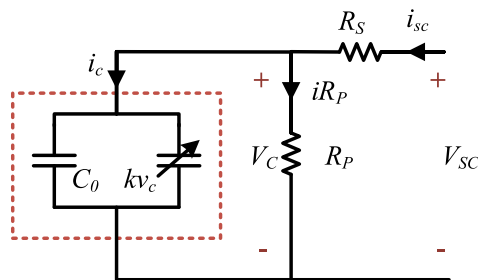

FIGURE 21. Equivalent model of SC [132].

Thus, the total capacitance denotes the real capacitance ( $C_r$ ) of SC, as shown in the following:

$$C_r = C_o + k.v_c \tag{13}$$

In [133], the application of the supercapacitor for the proper operation of MG in grid-connected and islanded modes of operation for normal and faulty conditions was illustrated. In [134], another application of SC in the railroad was discussed, where 55.5% system efficiency was recorded. In other applications, the efficiency of SC is almost in the range of 84%–97%. Despite having all these advantages, this SC has some drawbacks, which include the high self-discharge rate (up to 40% per day) and costs (6000 dollars/kWh). To overcome these challenges, the ongoing study focuses on the cost-effective multi-layer SCs that consist of materials, such as carbon, graphene, or paper [55], [135]. The researchers now focus on the development of electrode-based on ultra-small Si nanoparticles in polyaniline for SC [136].

## 2) SUPER MAGNETIC ENERGY STORAGE (SMES) SYSTEMS

SMES systems mainly work based on the principal of electrodynamics [137]. In this storage system, energy is stored in the magnetic field by the circulation of current in a superconducting coil with the help of an AC to DC converter (charging mode). However, the stored energy can be released back to the grid using the DC to AC converter (discharging mode). Ohmic losses in this technology can generate heat in the system and thus cause the thermal instability of SMES [138].

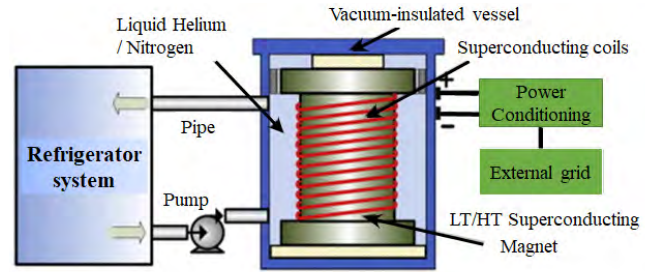

FIGURE 22. Principal diagram of SMES system [69].

To reduce ohmic loss, coil temperature is maintained under its superconductive temperature.

The two types of SMES systems can be described as follows: high-temperature SMES (HTS) that operates at approximately 70 K and low-temperature SMES (LTS) that operates at approximately 7K. Fig. 22 shows the basic diagram of the SMES system [69]. The LTS system is a more mature technology than the HTS system. This method can provide fast response to charging and discharging phenomena, which are limited to few milliseconds. Moreover, this system has high energy density (4 kW/l) and high efficiency (95%–98%) with a long lifetime of approximately 30 years. Energy stored in the SMES devices can be expressed as follows:

$$W_{LS} = \frac{1}{2}L \times I^2, \tag{14}$$

where  $L$  denotes the self-inductance of the coil,  $I$  is the amount of current that flows through the coil, and  $W_{LS}$  is the amount of stored energy in the coil.

SMES systems are available in the range of 0.1–10 MW for commercial use. With the advancement of technology, the capacity is expected to increase to approximately 100 MWh in the next decade. However, due to the complexity of the cooling system and coil material, the cost of the SMES system installation is still high (\$10,000/kWh) [58] [71]. Moreover, frequent changes in the operating current in this technology make SMES unstable. This problem was solved in [138]. SMES technology is basically applicable in UPSs and improves power quality. It has become fashionable for MG applications due to the flexible characteristics it offers in exchanging real and reactive power [139]. Current studies on SMES devices are based on reducing the cost of coils and cooling systems to make this storage device highly attractive to consumers. Moreover, a hybrid SMES system could be developed to increase storage capacity [140].

## E. THERMAL STORAGE SYSTEMS

The thermal energy storage (TES) system has the capability to store energy in the form of heat or ice, which can be released later when required. It is an alternative technology to replace the use of fossil fuels and can meet the demand of sustainable energy regulations. Research on TES has shown that the use of TES is expected to grow by 11% between 2017 and 2022 [141]. This technology is suitable to use for industrial

and residential sectors, such as for heating or cooling systems, load shifting, and power generation. The various applications of TES have been discussed in previous studies [142].

TES can be mainly categorized into two groups given the operating temperature: low-temperature TES (LTTES) and high-temperature TES (HTTES). LTTES operates at a temperature below 200 °C and can be applied to solar cooking and water heating [143], [144]. High-temperature TES can further be classified into three categories: sensible heat (SHS), latent heat (LHS), and absorption and adsorption system (AAS). SHS can be sensed by temperature, and the heat capacity along with the mass of the medium determines the storage capacity of the TES system [8]. The storage media can be of a different form, such as liquid (water, molten salt, and thermal oil), solid (stone, concrete, metal, and ground), or liquid with a solid filler material (molten salt/stone) [145]. Size is the main disadvantage of this SHS.

LHS is not sensitive to temperature. Thermal conductivity is an essential feature of this technology, which can be improved using paraffin, metallic fillers, metal matrix structures, finned tube, and aluminum shavings. Phase change materials are used as a storage medium, which can be organic, inorganic, and bio-based. The determinants of storage capacity are density and enthalpy [8], [52], [145]. AAS is the indirect way of storing energy as heat where energy is stored in the physicochemical process. It is also called a thermo-chemical storage system. The main advantage of this method is high energy density (approximately 1000 MJ/m<sup>3</sup>) [145]. TES is advantageous with its low capital cost (\$3–60/kWh), low self-discharge rate (–0.05%–1%), secured energy, environment-friendliness, and acceptable energy density [146]. However, life expectancy remains low (–30%–60%). The most common application of this technology is its integration with MG given that it can store ice at night and release energy by using water to cool the refrigeration system at daytime [147]. Thus, advanced research on the longer life cycle can make the system highly attractive for applications.

**F. HYBRID ENERGY STORAGE SYSTEMS**

Hybrid ESS (HESS) refers to the integration of two or more ESSs that were applied to achieve the advantages of each ESS for obtaining excellent characteristics in one particular application. It is not possible to provide all the features by one ESS type. Thus, the integration of ESS has become the demand for modern technology, such as MG. According to [148], high-power ESS devices are useful for fast response at high rates for short duration, whereas high-energy devices show the slow response with the more extended period. MG needs an ESS that combines the characteristics of high power and high energy storage system to improve the stability and reliability of the system with the reduction of the power quality problems [149].

The control strategy of HESS is more complicated than that of a single ESS, and many features are involved, such

as charging/discharging characteristics, response time, power distribution, life cycle, and efficiency. This new development for storing energy has been investigated by several researchers using many techniques. The possible HESS configurations are listed in Table 4 [148].

**TABLE 4. Possible chart of HESS configurations [148].**

Storage devices that provide high energy	Storage devices that provide high power
Battery	<ul style="list-style-type: none"> <li>• Supercapacitor (SC)</li> <li>• SMES</li> <li>• FES</li> </ul>
Compress Air (CAES)	<ul style="list-style-type: none"> <li>• Supercapacitor</li> <li>• SMES</li> <li>• FES</li> <li>• Battery</li> </ul>
Fuel cell	<ul style="list-style-type: none"> <li>• SC</li> <li>• SMES</li> <li>• FES</li> <li>• Battery</li> </ul>
Pumped hydro	<ul style="list-style-type: none"> <li>• SC</li> <li>• SMES</li> <li>• FES</li> <li>• Battery</li> </ul>

Literature review on the HESS technology shows that, for MG applications, the integration of battery/SC [16], battery/SMES [22], [150], battery/ FC [151], FC/ SC [132], and SC/RFB [149] is possible. Battery/SC technology is now highly popular and widely applicable. Battery/SMES HESS topology has been investigated to improve the efficiency of a wind plant [152], which compensates the fluctuation of loads in railway applications [153], the extended life cycle of battery [154], and frequency control in MG [150]. For application in MG, HESS shows better performance in frequency stabilization compared with the battery-only system. In this application, the battery life cycle is improved because it obtains protection from high frequency charging or discharging cycles and peak currents. Reference [22] reveals that the battery life can be extended from 5.7 to 9.2 years by the proposed HESS topology. Reference [151] demonstrated a HESS topology of battery/FC, where the battery was used as a primary storage device for short to medium duration, and HFC was applied as a long-term storage device. The limitation of slow response in the battery can be overcome by the fast response characteristics of HFC. Moreover, this HESS topology shows higher specific power than HFC alone. FC/SC HESS for MG applications also show better performance (8.5% more efficiency) than FC storage system only [132].

#### a: APPLICATION OF BATTERY/SUPERCAPACITOR ENERGY STORAGE SYSTEMS IN MICROGRID

Many studies have investigated on the hybridization of battery/ SC for many years. This topic is mostly popular with the researchers because it can provide comparatively large storage capacity with fast charging and discharging characteristics [155]. A dynamic model for this structure has been proposed in [156]. This model is capable of stabilizing the frequency fluctuation in MG application. The use of SC gives the battery relief from stress by restricting oscillations and sudden transients. Apart from these characteristics, protecting the system internal power and making full use of energy are also the important considerations for HESS [157]. A grid integrated hybrid MG system with HESS has been developed, as shown in Fig. 23 [158]. MG plays a vital dual role characteristics by acting as a rectifier from the AC-side and as an inverter from the DC-side.

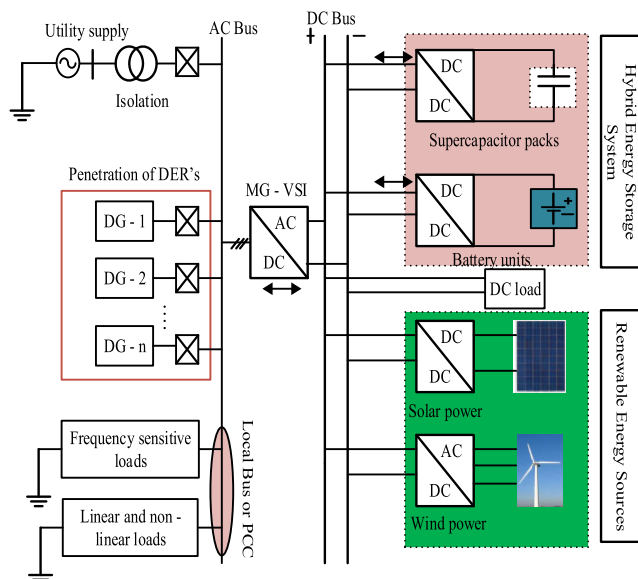

FIGURE 23. Topology of hybrid MG system with HESS [158].

This HESS technology improves the extension of life cycle up to 75% through peak shaving and related thermal burden reaction [159]. All the associated research on battery/SC reveals that this is a much improved, reliable, and easily accessible technology that satisfies the demand of the system and optimize battery operation. Therefore, system efficiency and life expectancy of the battery have been improved with this HESS mechanism.

#### IV. ISSUES AND CHALLENGES OF ESS IN MG APPLICATIONS

The current status of ESS technology along with the development of HESS can mitigate many challenges faced by the previous technology, such as efficiency or storage capacity. However, the scope of the further development of this technology for the future application in MG technology given that

BESS technology has lost his attractiveness due to calendric ageing and cyclic ageing [160]. Research is now focused based on the sizing, costing, safety, or efficient management of energy in the system. Thus, the key issues and challenges can be identified regarding material selection, power electronic interfacing, energy balance between ESS and MG, environmental impact, and the safety of this technology. The following subsections give a detailed overview of these key issues along with the selective recommendations.

##### A. MATERIALS SELECTION

Material selection, cost of materials, and availability of raw materials are the most important criteria for ESS system. Materials determine the life cycle of the storage device. Several storage materials and their development strategy for various storage, such as mechanical, thermal, hydrogen, gravity, electromagnetic, and electrochemical devices, have been discussed in different studies. However, the material selection is not optimal in most cases [81]. For the further development of ESS in MG application, the performance of high-grade ESS materials with their significant contribution must be addressed [161]. Charging and discharging characteristics, capacity, energy and power density, life cycle, and corrosiveness can be greatly influenced by the materials [8], [98], [145], [162]. The existing ESS mechanism with large storage capacity, such as flywheel, pumped hydro, SMES, lithium-ion battery, NaS battery, and flow battery are still costly in the electricity market. Moreover, hybrid ESS, such as a battery/supercapacitor, gives a large capacity storage facility, but the efficiency of this HESS technology can further be developed. Thus, a cost-effective long-term advanced technology can lead the material selection of ESS in MG application with improved energy efficiency and stability.

##### B. POWER ELECTRONIC INTERFACE

The power electronic interface deals with the technique to ensure the power quality, performance, power regulation, reliability, durability, and efficiency of the system [105], [163]. To increase the usefulness of the MG system, power electronic interface (PEI) may be used to integrate MG with ESS and the existing electrical power network. PEI has various characteristics because it has the necessary arrangement for power conversion with the help of a rectifier and an inverter. For PEI applications, different converters, such as buck, boost, buck-boost, cûk, half-bridge, flyback, H-bridge, and Z-source converter, may be used, which can be categorized under DC-DC, DC-AC, AC-AC, and AC-DC converter topology. Based on the storage technology, such as SC, FC, FESS, BESS, or SMES, and their applications, a power converter allows the connection among the two dc bus of unequal voltage, a dc bus, and an ac bus or even the connection of a current source to a voltage bus [98], [105]. The existing PEI system has disadvantages in size, ripples, cost, flexibility, and efficiency [105], [164]; thus, advanced research may be

needed on the PEI system to overcome the challenges for the efficient operation of the storage technology.

### C. ENERGY MANAGEMENT SYSTEM

Optimization in distributing the power in the ESS topology for MG applications can be performed by sharing the power of the energy management system (EMS). Several ESS, such as CAES, GES, and Li-ion battery can be modeled for large-scale integration, whereas TES, SMES, FBs, and fuel cells are efficient for medium-scale energy management [58]. To design an efficient EMS, the minimization of the overall system loss and the control of SOC can play a vital role in optimizing the efficiency and keeping the reserve for future demand, respectively [165]. Moreover, HESS can control power fluctuation, which improves power quality and limits the maximum active power change rate. Thus, they can be a better alternative than a single ESS system. The different topologies of HESS have been discussed in this review. Battery/SC HESS topology is observed to be a good choice for future development. Therefore, modern ESS management for MG applications with reliable and stable characteristics could be optimized by a quality management system, which increases the overall efficiency and reduces the cost.

### D. SIZE AND COST OF ESS

The size and cost of different ESS technologies are quite high. If the size increases, so does the cost. As discussed in different studies on compressed air, flywheel, HFC, gravity, and thermal or battery storage, size depends on the energy rating and power rating [45], [166]. Oversized ESS is not suitable. Cost incorporates installation and maintenance costs. The per unit cost of energy is also an important factor in energy technology. Cost depends on the storage materials, capacity, charging/discharging rate, DoD, and life cycle [80], [167]. Although the cost of different ESS is high in different categories and obtains stable and reliable operation, ESS is an unavoidable solution to MG. Given the expected price reduction of some new technologies (such as GES, Li-ion, flow battery, NiCd, or Ni-Zn) in the near future and reviewing the existing storage, such as PHS, CAES, FES, FC, and TES, stabilizing voltage and frequency fluctuation of single ESS in MG has many limitations. Therefore, with the advancement of technology, HESS has been developed to integrate more technologies to achieve an efficient operation with energy arbitrage, peak shaving, time shifting, and voltage support [42]. The capacity of the storage system can be increased with their integration, such as battery/SC, battery/flywheel, battery/SMES, CAES/SC, CAES/flywheel, and FC/SMES, which helps reduce the overall size and cost of the plant by avoiding the inclusion of more storage devices separately. It also has a strong contribution in increasing the life expectancy of storage [148]. Thus, adopting a comprehensive energy storage policy to balance the power to reduce the cost and increase reliability would be a major challenge for renewable and conventional network systems.

### E. ENVIRONMENTAL IMPACT

Research on the environmental impact has already proven that, as the energy produced by renewable sources increases, the emission of greenhouse gas or other toxic emissions decrease [168]. Environmental hazards take place from the combustion of fossil fuel (CAES), magnetic field (SMES), recyclable materials, or chemicals of the storage system during manufacture and disposal time. HESS can integrate the intermittent renewable energy sources in electricity grid and thus can reduce fuel consumption and toxic emission [2]. Although 100% RE production is costly [168], researchers aim to reduce the installation and maintenance costs of the RE sources to ensure sustainable development.

### F. SAFETY ISSUES

The safety of ESS has become the demand for modern MG applications. For safe and secure operations, various factors, such as the magnetic characteristics of materials, life cycle, temperature, short-circuit problem, overcharging, and over-discharging characteristics of ESS, must be addressed efficiently. This process can decrease the uncertainty and intermittency of the system. SMES should have the control to reduce the ohmic losses; CAES, TES, and NaS batteries require temperature control mechanism; SC storage suffers from high self-discharge rate; fuel cells demand safety from corrosion with low- and high-temperature management; lead-acid batteries need regular maintenance during operation; and Li-ion batteries need overcharging and over-discharging protection [169]–[172]. Therefore, recent research can focus on overcoming these issues to make the technology highly user-friendly.

### V. DISCUSSION AND CONCLUSION

ESSs technologies are an alternative solution for the potential utilization of renewable energy in MG applications. Many researchers are involved in the development of ESSs and their utilizations in MG to manage the decent power balance by storing energy during off-peak hours with reduced cost. Therefore, the perfection in the modeling of ESSs with optimization characteristics are the key features of next-generation ESS technologies. However, the development of an efficient ESS for MG applications is a challenging issue. Moreover, almost all studies and reviews are limited in the ESS types, characteristics, and their configurations with advantages and disadvantages. The present study highlights the different technologies of ESS, their constructions, operations, and energy transformation mechanisms to provide a concrete overview for ensuring the sustainability of future ESS systems in solving environmental and economic problems. This study also reviewed the implementation of individual ESS, such as flywheel, compressed air, battery, fuel cell, supercapacitor, super magnetic, redox flow, lithium-ion, and the hybrid ESS, such as battery/supercapacitor, battery/SMES, and battery/F in MG operation. Moreover, energy and power density, response time, size, efficiency,



cost, life cycle, and material selection have been explained in various parts of this review. This review also anticipated the advanced power electronics interface between ESS and MG toward the mature hybrid ESS with optimum features.

This rigorous review suggests that the optimization of ESS materials and chemical solutions can increase the storage capacity, life cycle, and efficiency of the device. To ensure better performance with reliable operation, this study reveals that hybrid ESS is highly attractive in MG applications. This review highlighted many factors, challenges, and their possible solutions and suggestions for next-generation ESSs in MG applications, which may help academics, researchers, and industries to modify and improve the existing ESSs into an advanced level. Thus, the key contribution of this study is the comprehensive analysis of different ESS integration in MG applications to provide a comprehensive idea on the advanced ESSs and their future deployment in the MG network. The review has proposed important and selective suggestions for the further technological development on ESS in MG applications:

- Advanced research is required to improve next-generation ESS in MG applications. Some issues of ESS exist in terms of materials, size, and cost. Control interface, environment, and safety must be addressed to reach proper system functionality and market acceptance.
- The long-term plan for ESS is to design a cost-effective, reliable, and capacity facility to lead the sustainable utilization of ESS in MG operation.
- An advanced power electronic system may proceed to overcome the switching challenges and safety circuitry issues and address the overheating and over charging/discharging phenomena for efficient ESS operation.
- An optimal EMS and advanced ESS topology could be a good choice for future development to increase overall efficiency and reduce cost.
- Appropriate techniques must be developed to find the optimal size of the ESS to achieve an efficient operation with energy arbitrage, peal shaving, time shifting, and voltage support. The energy storage policy is adopted to balance power and increase reliability, which would lead to a significant potential for ESS in MG applications.
- The development of a suitable model for the ESS that considers various sub-models, such as charging/discharging, optimal size, schedule controller, safety, and protection, must be studied further.
- Further research must be conducted on the ESS materials and chemical solution optimization to increase storage capacity, life cycle, and efficiency.
- For an environmental impact analysis, emission reduction and cost-saving models must be developed to ensure sustainable ESS development and reduce negative environmental impacts if any.
- Investigation should be undertaken on ESS integration into MG to overcome the synchronizing complexity, improve the integration performance or islanded operation, and increase the computational speed.

- Further research should be performed on the safe and secure ESS operation, which considers temperature, short-circuit problem, and overcharging and over-discharging characteristics.

These suggestions would be remarkable contributions toward the maturity of ESS technologies, which are expected to dominate the electricity market in the future. Therefore, advanced research based on this review may significantly overcome the limitations of the existing ESS technologies in MG applications to meet future sustainable energy utilization.

## REFERENCES

- [1] D. Sandoval, P. Goffin, and H. Leibundgut, "How low exergy buildings and distributed electricity storage can contribute to flexibility within the demand side," *Appl. Energy*, vol. 187, pp. 116–127, Feb. 2017.
- [2] M. Di Somma et al., "Operation optimization of a distributed energy system considering energy costs and exergy efficiency," *Energy Convers. Manage.*, vol. 103, pp. 739–751, Oct. 2015.
- [3] A. Kostevšek, J. J. Klemenč, P. S. Varbanov, L. Čuček, and J. Petek, "Sustainability assessment of the locally integrated energy sectors for a slovenian municipality," *J. Cleaner Prod.*, vol. 88, pp. 83–89, Feb. 2015.
- [4] G. Boukettaya and L. Krichen, "A dynamic power management strategy of a grid connected hybrid generation system using wind, photovoltaic and flywheel energy storage system in residential applications," *Energy*, vol. 71, pp. 148–159, Jul. 2014.
- [5] *U.S. Climate Action Report*, U.S. Dept., Washington, DC, USA, 2014.
- [6] J. G. J. Olivier, G. Janssens-Maenhout, M. Muntean, and J. A. H. W. Peters, "Trends in global CO<sub>2</sub> emissions: 2016 Report," PBL Netherlands Environ. Assessment Agency, The Hague, The Netherlands, Tech. Rep. 103425, 2016, p. 86.
- [7] F. Hacker, R. Harthan, F. Matthes, and W. Zimmer, "Environmental impacts and impact on the electricity market of a large scale introduction of electric cars in Europe—Critical review of literature," *ETC/ACC Tech. Paper*, vol. 4, pp. 56–90, Jan. 2009.
- [8] *Electrical Energy Storage—White Paper*, Int. Electrotech. Commission, Geneva, Switzerland, 2011, pp. 1–78.
- [9] F. Liu, J. Liu, H. Zhang, and D. Xue, "Stability issues of Z + Z type cascade system in hybrid energy storage system (HESS)," *IEEE Trans. Power Electron.*, vol. 29, no. 11, pp. 5846–5859, Nov. 2014.
- [10] P. Wang, J. Xiao, and L. Setyawan, "Hierarchical control of hybrid energy storage system in DC microgrids," *IEEE Trans. Ind. Electron.*, vol. 62, no. 8, pp. 4915–4924, Aug. 2015.
- [11] J. Han, S. K. Solanki, and J. Solanki, "Coordinated predictive control of a wind/battery microgrid system," *IEEE J. Emerg. Sel. Topics Power Electron.*, vol. 1, no. 4, pp. 296–305, Dec. 2013.
- [12] X. Tan, Q. Li, and H. Wang, "Advances and trends of energy storage technology in microgrid," *Int. J. Elect. Power Energy Syst.*, vol. 44, no. 1, pp. 179–191, 2013.
- [13] F. A. Bhuiyan and A. Yazdani, "Energy storage technologies for grid-connected and off-grid power system applications," in *Proc. IEEE Elect. Power Energy Conf. (EPEC)*, Oct. 2012, pp. 303–310.
- [14] M. Katsanevakis, R. A. Stewart, and J. Lu, "Aggregated applications and benefits of energy storage systems with application-specific control methods: A review," *Renew. Sustain. Energy Rev.*, vol. 75, pp. 719–741, Aug. 2017.
- [15] A. K. Rohit and S. Rangnekar, "An overview of energy storage and its importance in Indian renewable energy sector: Part II—Energy storage applications, benefits and market potential," *J. Energy Storage*, vol. 13, pp. 447–456, Oct. 2017.
- [16] W. Jing, C. H. Lai, W. S. H. Wong, and M. L. D. Wong, "Dynamic power allocation of battery-supercapacitor hybrid energy storage for standalone PV microgrid applications," *Sustain. Energy Technol. Assessments*, vol. 22, pp. 55–64, Aug. 2017.
- [17] M. R. Aghamohammadi and H. Abdolahinia, "A new approach for optimal sizing of battery energy storage system for primary frequency control of islanded microgrid," *Int. J. Electr. Power Energy Syst.*, vol. 54, pp. 325–333, Jan. 2014.
- [18] R. H. Lasseter, "MicroGrids," in *Proc. IEEE Power Eng. Soc. Winter Meeting*, Jan. 2002, pp. 305–308.

- [19] X. Fang, S. Misra, G. Xue, and D. Yang, "Smart grid—The new and improved power grid: A survey," *IEEE Commun. Surveys Tuts.*, vol. 14, no. 4, pp. 944–980, 4th Quart., 2012.
- [20] M. L. Di Silvestre, G. Graditi, and E. R. Sanseverino, "A generalized framework for optimal sizing of distributed energy resources in microgrids using an indicator-based swarm approach," *IEEE Trans. Ind. Inform.*, vol. 10, no. 1, pp. 152–162, Feb. 2014.
- [21] G. Graditi, M. G. Ippolito, E. Telaretti, and G. Zizzo, "An innovative conversion device to the grid interface of combined RES-based generators and electric storage systems," *IEEE Trans. Ind. Electron.*, vol. 62, no. 4, pp. 2540–2550, Apr. 2015.
- [22] J. Li, R. Xiong, Q. Yang, F. Liang, M. Zhang, and W. Yuan, "Design/test of a hybrid energy storage system for primary frequency control using a dynamic droop method in an isolated microgrid power system" *Appl. Energy*, vol. 201, pp. 257–269, Sep. 2017.
- [23] F. Díaz-González, F. D. Bianchi, A. Sumper, and O. Gomis-Bellmunt, "Control of a flywheel energy storage system for power smoothing in wind power plants," *IEEE Trans. Energy Convers.*, vol. 29, no. 1, pp. 204–214, Mar. 2014.
- [24] J. M. Guerrero, P. C. Loh, T.-L. Lee, and M. Chandorkar, "Advanced control architectures for intelligent microgrids—Part II: Power quality, energy storage, and AC/DC microgrids," *IEEE Trans. Ind. Electron.*, vol. 60, no. 4, pp. 1263–1270, Apr. 2013.
- [25] L. Yang, N. Tai, C. Fan, and Y. Meng, "Energy regulating and fluctuation stabilizing by air source heat pump and battery energy storage system in microgrid," *Renew. Energy*, vol. 95, pp. 202–212, Sep. 2016.
- [26] A. A. Salam, A. Mohamed, and M. A. Hannan, "TECHNical challenges on microgrids," *ARNP J. Eng. Appl. Sci.*, vol. 3, no. 6, pp. 64–69, 2008.
- [27] C. L. Trujillo, D. Velasco, E. Figueres, and G. Garcera, "Analysis of active islanding detection methods for grid-connected microinverters for renewable energy processing," *Appl. Energy*, vol. 87, no. 11, pp. 3591–3605, 2010.
- [28] T. Ma, H. Yang, and L. Lu, "A feasibility study of a stand-alone hybrid solar-wind-battery system for a remote island," *Appl. Energy*, vol. 121, pp. 149–158, May 2014.
- [29] M. Bragard, N. Soltan, S. Thomas, and R. W. De Doncker, "The balance of renewable sources and user demands in grids: Power electronics for modular battery energy storage systems," *IEEE Trans. Power Electron.*, vol. 25, no. 12, pp. 3049–3056, Dec. 2010.
- [30] Y. Levron and D. Shmilovitz, "Power systems' optimal peak-shaving applying secondary storage," *Electr. Power Syst. Res.*, vol. 89, pp. 80–84, Aug. 2012.
- [31] A. Mohd, E. Ortjohann, A. Schmelter, N. Hamsic, and D. Morton, "Challenges in integrating distributed energy storage systems into future smart grid," in *Proc. IEEE Int. Symp. Ind. Electron.*, Jul. 2008, pp. 1627–1632.
- [32] F. Díaz-González, A. Sumper, O. Gomis-Bellmunt, and R. Villafafila-Robles, "A review of energy storage technologies for wind power applications," *Renew. Sustain. Energy Rev.*, vol. 16, no. 4, pp. 2154–2171, 2012.
- [33] G. Huff et al., "DOE/EPRI 2013 electricity storage handbook in collaboration with NRECA," Sandia Nat. Lab., Albuquerque, NM, USA, SANDIA Rep. SAND2013-5131, Jul. 2013, p. 340.
- [34] J. W. Feltes and C. Grande-Moran, "Black start studies for system restoration," in *Proc. IEEE Power Energy Soc. General Meeting-Convers. Del. Elect. Energy 21st Century PES*, Jul. 2008, pp. 1–8.
- [35] Y. M. Atwa, E. F. El-Saadany, M. M. A. Salama, and R. Seethapathy, "Optimal renewable resources mix for distribution system energy loss minimization," *IEEE Trans. Power Syst.*, vol. 25, no. 1, pp. 360–370, Feb. 2010.
- [36] J. Mundackal, A. C. Varghese, P. Sreekala, and V. Reshmi, "Grid power quality improvement and battery energy storage in wind energy systems," in *Proc. Annu. Int. Conf. Emerg. Res. Areas Int. Conf. Microelectron. Commun. Renew. Energy*, Jun. 2013, pp. 1–6.
- [37] J. M. Carrasco et al., "Power-electronic systems for the grid integration of renewable energy sources: A survey," *IEEE Trans. Ind. Electron.*, vol. 53, no. 4, pp. 1002–1016, Jun. 2006.
- [38] C. A. Hill, M. C. Such, D. Chen, J. Gonzalez, and W. M. Grady, "Battery energy storage for enabling integration of distributed solar power generation," *IEEE Trans. Smart Grid*, vol. 3, no. 2, pp. 850–857, Jun. 2012.
- [39] A. S. Subburaj, B. N. Pushpakaran, and S. B. Bayne, "Overview of grid connected renewable energy based battery projects in USA," *Renew. Sustain. Energy Rev.*, vol. 45, pp. 219–234, May 2015.
- [40] R.-C. Leou, "An economic analysis model for the energy storage system applied to a distribution substation," *Int. J. Elect. Power Energy Syst.*, vol. 34, no. 1, pp. 132–137, 2012.
- [41] A. Saez-de-Ibarra et al., "Analysis and comparison of battery energy storage technologies for grid applications," in *Proc. IEEE Grenoble Conf.*, Jun. 2013, pp. 1–6.
- [42] O. Palizban and K. Kauhaniemi, "Energy storage systems in modern grids—Matrix of technologies and applications," *J. Energy Storage*, vol. 6, pp. 248–259, May 2016.
- [43] W. Li and G. Joos, "Comparison of energy storage system technologies and configurations in a wind farm," in *Proc. IEEE Power Electron. Spec. Conf.*, Jun. 2007, pp. 1280–1285.
- [44] M. A. Hannan, M. M. Hoque, A. Mohamed, and A. Ayob, "Review of energy storage systems for electric vehicle applications: Issues and challenges," *Renew. Sustain. Energy Rev.*, vol. 69, pp. 771–789, Mar. 2017.
- [45] I. Alsaaidan, A. Khodaei, and W. Gao, "A comprehensive battery energy storage optimal sizing model for microgrid applications," *IEEE Trans. Power Syst.*, Nov. 2017, doi: 10.1109/TPWRS.2017.2769639.
- [46] H. Ibrahim, K. Belmokhtar, and M. Ghandour, "Investigation of usage of compressed air energy storage for power generation system improving—Application in a microgrid integrating wind energy," *Energy Procedia*, vol. 73, pp. 305–316, Jun. 2015.
- [47] A. A. K. Arani, H. Karami, G. B. Gharehpetian, and M. S. A. Hejazi, "Review of flywheel energy storage systems structures and applications in power systems and microgrids," *Renew. Sustain. Energy Rev.*, vol. 69, pp. 9–18, Mar. 2017.
- [48] F. A. Inthamoussou, J. Pegueroles-Queral, and F. D. Bianchi, "Control of a supercapacitor energy storage system for microgrid applications," *IEEE Trans. Energy Convers.*, vol. 28, no. 3, pp. 690–697, Sep. 2013.
- [49] T.-T. Nguyen, H.-J. Yoo, and H.-M. Kim, "Applying model predictive control to SMES system in microgrids for eddy current losses reduction," *IEEE Trans. Appl. Supercond.*, vol. 26, no. 4, Jun. 2016, Art. no. 5400405.
- [50] S. A. Konstantinopoulos, A. G. Anastasiadis, G. A. Vokas, G. P. Kondylis, and A. Polyzakis, "Optimal management of hydrogen storage in stochastic smart microgrid operation," *Int. J. Hydrogen Energy*, vol. 43, no. 1, pp. 490–499, 2017.
- [51] G. Oriti, A. L. Julian, N. Anglani, and G. D. Hernandez, "Novel hybrid energy storage control for a single phase energy management system in a remote islanded microgrid," in *Proc. IEEE Energy Convers. Congr. Expo. (ECCE)*, Oct. 2017, pp. 1552–1559.
- [52] M. S. Guney and Y. Tepe, "Classification and assessment of energy storage systems," *Renew. Sustain. Energy Rev.*, vol. 75, pp. 1187–1197, Aug. 2017.
- [53] Y. A. Göğüş, "Mechanical energy storage," *Energy Storage Syst.*, vol. 1, pp. 1–396, 2009.
- [54] M. Aneke and M. Wang, "Energy storage technologies and real life applications—A state of the art review," *Appl. Energy*, vol. 179, pp. 350–377, Oct. 2016.
- [55] X. Luo, J. Wang, M. Dooner, and J. Clarke, "Overview of current development in electrical energy storage technologies and the application potential in power system operation," *Appl. Energy*, vol. 137, pp. 511–536, Jan. 2015.
- [56] G. Locatelli, D. C. Invernizzi, and M. Mancini, "Investment and risk appraisal in energy storage systems: A real options approach," *Energy*, vol. 104, pp. 114–131, Jun. 2016.
- [57] A. Sciacovelli, A. Vecchi, and Y. Ding, "Liquid air energy storage (LAES) with packed bed cold thermal storage—From component to system level performance through dynamic modelling," *Appl. Energy*, vol. 190, pp. 84–98, Mar. 2017.
- [58] H. Chen, T. N. Cong, W. Yang, C. Tan, Y. Li, and Y. Ding, "Progress in electrical energy storage system: A critical review," *Prog. Nat. Sci.*, vol. 19, no. 3, pp. 291–312, 2009.
- [59] I. Hadjipaschalis, A. Poullikkas, and V. Efthymiou, "Overview of current and future energy storage technologies for electric power applications," *Renew. Sustain. Energy Rev.*, vol. 13, nos. 6–7, pp. 1513–1522, 2009.
- [60] T. Hyttinen, "Hybrid power generation concept for small grids," M.S. thesis, Dept. Elect. Energy Eng., Univ. Vaasa, Vaasa, Finland, 2013.
- [61] M. E. Amiryar and K. Pullen, "A review of flywheel energy storage system technologies and their applications," *Appl. Sci.*, vol. 7, no. 3, p. 286, 2017.
- [62] M. G. Molina, "Distributed energy storage systems for applications in future smart grids," in *Proc. 6th IEEE/PES Transmiss. Distrib., Latin Amer. Conf. Expo. (T&D-LA)*, Sep. 2012, pp. 1–7.

- [63] Y. Xu et al., "Design of a multipulse high-magnetic-field system based on flywheel energy storage," *IEEE Trans. Appl. Supercond.*, vol. 26, no. 4, pp. 3–7, Jun. 2016.
- [64] K. Xu, D.-J. Wu, Y. L. Jiao, and M. H. Zheng, "A fully superconducting bearing system for flywheel applications," *Supercond. Sci. Technol.*, vol. 29, no. 6, p. 64001, 2016.
- [65] Y. Yuan, Y. Sun, and Y. Huang, "Design and analysis of bearingless flywheel motor specially for flywheel energy storage," *Electron. Lett.*, vol. 52, no. 1, pp. 66–68, 2016.
- [66] R. Sebastián and R. P. Alzola, "Flywheel energy storage systems: Review and simulation for an isolated wind power system," *Renew. Sustain. Energy Rev.*, vol. 16, no. 9, pp. 6803–6813, 2012.
- [67] S. R. Gurumurthy, V. Agarwal, and A. Sharma, "High-efficiency bidirectional converter for flywheel energy storage application," *IEEE Trans. Ind. Electron.*, vol. 63, no. 9, pp. 5477–5487, Sep. 2016.
- [68] M. R. Patel, *Wind and Solar Power Systems: Design, Analysis, and Operation*, 2nd ed. Boca Raton, FL, USA: CRC Press, 2012.
- [69] R. Amirante, E. Cassone, E. Distaso, and P. Tamburrano, "Overview on recent developments in energy storage: Mechanical, electrochemical and hydrogen technologies," *Energy Convers. Manage.*, vol. 132, pp. 372–387, Jan. 2017.
- [70] R. D. Allen, T. J. Doherty, and L. D. Kannberg, "Summary of selected compressed air energy storage studies," Pacific Northwest Labs, Richland, WA, USA, Tech. Rep. PNL-5091, 1985.
- [71] X. Luo, J. Wang, M. Dooner, J. Clarke, and C. Krupke, "Overview of current development in compressed air energy storage technology," *Energy Procedia*, vol. 62, no. 2014, pp. 603–611, 2014.
- [72] M. Raju and S. K. Khaitan, "Modeling and simulation of compressed air storage in caverns: A case study of the Huntorf plant," *Appl. Energy*, vol. 89, no. 1, pp. 474–481, 2012.
- [73] P. Zhao, J. Wang, and Y. Dai, "Thermodynamic analysis of an integrated energy system based on compressed air energy storage (CAES) system and Kalina cycle," *Energy Convers. Manage.*, vol. 98, pp. 161–172, Jul. 2015.
- [74] W.-D. Steinmann, "Thermo-mechanical concepts for bulk energy storage," *Renew. Sustain. Energy Rev.*, vol. 75, pp. 205–219, Aug. 2017.
- [75] R. Madlener and J. Latz, "Economics of centralized and decentralized compressed air energy storage for enhanced grid integration of wind power," *Appl. Energy*, vol. 101, pp. 299–309, Jan. 2013.
- [76] H. Guo, Y. Xu, H. Chen, and X. Zhou, "Thermodynamic characteristics of a novel supercritical compressed air energy storage system," *Energy Convers. Manage.*, vol. 115, pp. 167–177, May 2016.
- [77] H. Liu, Q. He, A. Borgia, L. Pan, and C. M. Oldenburg, "Thermodynamic analysis of a compressed carbon dioxide energy storage system using two saline aquifers at different depths as storage reservoirs," *Energy Convers. Manage.*, vol. 127, pp. 149–159, Nov. 2016.
- [78] E. Yao, H. Wang, L. Wang, G. Xi, and F. Maréchal, "Thermo-economic optimization of a combined cooling, heating and power system based on small-scale compressed air energy storage," *Energy Convers. Manage.*, vol. 118, pp. 377–386, Jun. 2016.
- [79] A. Berrada, K. Loudiyi, and R. Garde, "Dynamic modeling of gravity energy storage coupled with a PV energy plant," *Energy*, vol. 134, pp. 323–335, Sep. 2017.
- [80] A. Berrada, K. Loudiyi, and I. Zorkani, "System design and economic performance of gravity energy storage," *J. Cleaner Prod.*, vol. 156, pp. 317–326, Jul. 2017.
- [81] A. Berrada and K. Loudiyi, "Modeling and material selection for gravity storage using FEA method," in *Proc. Int. Renew. Sustain. Energy Conf. (IRSEC)*, Nov. 2016, pp. 1159–1164.
- [82] K. C. Divya and J. Østergaard, "Battery energy storage technology for power systems—An overview," *Electr. Power Syst. Res.*, vol. 79, no. 4, pp. 511–520, 2009.
- [83] C. Daniel and J. O. Besenhard, Eds., *Handbook of Battery Materials*, 2nd ed. Hoboken, NJ, USA: Wiley, 2011.
- [84] B. Dunn, H. Kamath, and J.-M. Tarascon, "Electrical energy storage for the grid: A battery of choices," *Science*, vol. 334, no. 6058, pp. 928–935, 2011.
- [85] H. Ibrahim, A. Ilinca, and J. Perron, "Energy storage systems—Characteristics and comparisons," *Renew. Sustain. Energy Rev.*, vol. 12, no. 5, pp. 1221–1250, 2008.
- [86] X. Xu, M. Bishop, D. G. Oikarinen, and C. Hao, "Application and modeling of battery energy storage in power systems," *CSEE J. Power Energy Syst.*, vol. 2, no. 3, pp. 82–90, Sep. 2016.
- [87] S. M. Lukic, J. Cao, R. C. Bansal, F. Rodriguez, and A. Emadi, "Energy storage systems for automotive applications," *IEEE Trans. Ind. Electron.*, vol. 55, no. 6, pp. 2258–2267, Jun. 2008.
- [88] D. Parra et al., "An interdisciplinary review of energy storage for communities: Challenges and perspectives," *Renew. Sustain. Energy Rev.*, vol. 79, pp. 730–749, Nov. 2017.
- [89] M. A. Hannan, M. S. H. Lipu, A. Hussain, and A. Mohamed, "A review of lithium-ion battery state of charge estimation and management system in electric vehicle applications: Challenges and recommendations," *Renew. Sustain. Energy Rev.*, vol. 78, pp. 834–854, Oct. 2017.
- [90] J. Baker, "New technology and possible advances in energy storage," *Energy Policy*, vol. 36, no. 12, pp. 4368–4373, 2008.
- [91] M. Verbrugge and E. Tate, "Adaptive state of charge algorithm for nickel metal hydride batteries including hysteresis phenomena," *J. Power Sources*, vol. 126, nos. 1–2, pp. 236–249, Feb. 2004.
- [92] T. Kousksou, P. Bruel, A. Jamil, T. El Rhafiki, and Y. Zeraoui, "Energy storage: Applications and challenges," *Sol. Energy Mater. Sol. Cells*, vol. 120, pp. 59–80, Jan. 2014.
- [93] Z. Yang et al., "Electrochemical energy storage for green grid," *Chem. Rev.*, vol. 111, no. 5, pp. 3577–3613, May 2011.
- [94] J. Noack, N. Roznyatovskaya, T. Herr, and P. Fischer, "The chemistry of redox-flow batteries" *Angewandte Chem.*, vol. 54, no. 34, pp. 9776–9809, 2015.
- [95] T. van Nguyen and R. F. Savinell, "Flow batteries," *Electrochem. Soc. Interface*, vol. 19, no. 3, pp. 54–56, 2010.
- [96] A.-I. Stroe, M. Swierczynski, D.-I. Stroe, and R. Teodorescu, "Performance model for high-power lithium titanate oxide batteries based on extended characterization tests," in *Proc. IEEE Energy Convers. Congr. Expo. (ECCE)*, Sep. 2015, pp. 6191–6198.
- [97] X. Wei et al., "Radical compatibility with nonaqueous electrolytes and its impact on an all-organic redox flow battery," *Angewandte Chem.*, vol. 54, no. 30, pp. 8684–8687, 2015.
- [98] S. Vazquez, S. M. Lukic, E. Galvan, L. G. Franquelo, and J. M. Carrasco, "Energy storage systems for transport and grid applications," *IEEE Trans. Ind. Electron.*, vol. 57, no. 12, pp. 3881–3895, Dec. 2010.
- [99] J. Cavanagh et al., "Electrical energy storage: Technology overview and applications," CSIRO-Newcastle, Mayfield West, NSW, Australia, Tech. Rep. EP 154 168, 2015.
- [100] J. Cho, S. Jeong, and Y. Kim, "Commercial and research battery technologies for electrical energy storage applications," *Prog. Energy Combust. Sci.*, vol. 48, pp. 84–101, Jun. 2015.
- [101] C. S. Lai, Y. Jia, L. L. Lai, Z. Xu, M. D. McCulloch, and K. P. Wong, "A comprehensive review on large-scale photovoltaic system with applications of electrical energy storage," *Renew. Sustain. Energy Rev.*, vol. 78, pp. 439–451, Oct. 2017.
- [102] H. Jia, Y. Mu, and Y. Qi, "A statistical model to determine the capacity of battery-supercapacitor hybrid energy storage system in autonomous microgrid," *Int. J. Elect. Power Energy Syst.*, vol. 54, pp. 516–524, Jan. 2014.
- [103] J. Khajesalehi, M. Hamzeh, K. Sheshyekani, and E. Afjei, "Modeling and control of quasi Z-source inverters for parallel operation of battery energy storage systems: Application to microgrids," *Electr. Power Syst. Res.*, vol. 125, pp. 164–173, Aug. 2015.
- [104] K. T. Chau, Y. S. Wong, and C. C. Chan, "An overview of energy sources for electric vehicles," *Energy Convers. Manage.*, vol. 40, no. 10, pp. 1021–1039, 1999.
- [105] M. H. Rashid, *Power Electronics Handbook*, 3rd ed. Burlington, MA, USA: Butterworth-Heinemann, 2011.
- [106] Y. Zeng, J. Hu, W. Ye, W. Zhao, and G. Zhou, "Investigation of lead dendrite growth in the formation of valve-regulated lead-acid batteries for electric bicycle applications," *J. Power Source*, vol. 286, pp. 182–192, Jul. 2015.
- [107] M. Jarnut, S. Werminiński, and B. Wańkiewicz, "Comparative analysis of selected energy storage technologies for prosumer-owned microgrids," *Renew. Sustain. Energy Rev.*, vol. 74, pp. 925–937, Jul. 2017.
- [108] E. Radu, P. Dorin, P. Toma, and L. Eniko, "An islanded renewable energy microgrid emulator for geothermal, biogas, photovoltaic and lead acid battery storage," in *Proc. IEEE 26th Int. Symp. Ind. Electron.*, Jun. 2017, pp. 2109–2114.
- [109] D. A. J. Rand and P. T. Moseley, *Lead-Acid Battery Fundamentals*. Amsterdam, The Netherlands: Elsevier, Mar. 2017, pp. 1–706.
- [110] D. Pavlov, *Lead-Acid Batteries: Science and Technology*, 2nd ed. Cambridge, MA, USA: Elsevier, 2017.

- [111] R. Xiong, Q. Yu, L. Y. Wang, and C. Lin, "A novel method to obtain the open circuit voltage for the state of charge of lithium ion batteries in electric vehicles by using  $H$  infinity filter," *Appl. Energy*, vol. 207, pp. 346–353, May 2017.
- [112] G. Graditi, M. G. Ippolito, E. Telaretti, and G. Zizzo, "Technical and economical assessment of distributed electrochemical storages for load shifting applications: An Italian case study," *Renew. Sustain. Energy Rev.*, vol. 57, pp. 515–523, May 2016.
- [113] J. Zhang, G. Wen, Z. Wu, X. Zhang, G. Ma, and J. Jin, "Sol-gel synthesis of  $Mg^{2+}$  stabilized  $Na-\beta''/\beta-Al_2O_3$  solid electrolyte for sodium anode battery," *J. Alloys Compounds*, vol. 613, pp. 80–86, Nov. 2014.
- [114] S.-H. Yu et al., "Hybrid cellular nanosheets for high-performance lithium-ion battery anodes," *Amer. Chem. Soc.*, vol. 137, no. 37, pp. 11954–11961, 2015.
- [115] J. Pegueroles-Queralt, F. D. Bianchi, and O. Gomis-Bellmunt, "Control of a lithium-ion battery storage system for microgrid applications," *J. Power Sour.*, vol. 272, pp. 531–540, Dec. 2014.
- [116] H. Qian, J. Zhang, J.-S. Lai, and W. Yu, "A high-efficiency grid-tie battery energy storage system," *IEEE Trans. Power Electron.*, vol. 26, no. 3, pp. 886–896, Mar. 2011.
- [117] D. Pavković, A. Sedić, and Z. Guzović, "Oil drilling rig diesel power-plant fuel efficiency improvement potentials through rule-based generator scheduling and utilization of battery energy storage system," *Energy Convers. Manage.*, vol. 121, pp. 194–211, Aug. 2016.
- [118] Z. Zhang, G. Wang, Y. Lai, and J. Li, "A freestanding hollow carbon nanofiber/reduced graphene oxide interlayer for high-performance lithium-sulfur batteries," *J. Alloys Compounds*, vol. 663, pp. 501–506, Apr. 2016.
- [119] N. Kawakami et al., "Development and field experiences of stabilization system using 34 MW NAS batteries for a 51 MW wind farm," in *Proc. IEEE Int. Symp. Ind. Electron.*, Jul. 2010, pp. 2371–2376.
- [120] *Sumitomo Electric Annual Report 2011 (Year-end 31st March 2011)*, Sumitomo Electr. Ingenious Dyn., Osaka, Japan, 2011, pp. 7–16.
- [121] B. Yang et al., "On the use of energy storage technologies for regulation services in electric power systems with significant penetration of wind energy," in *Proc. 5th Int. Conf. Eur. Electr. Market*, May 2010, pp. 1–6.
- [122] S. Tewari and N. Mohan, "Value of NAS energy storage toward integrating wind: Results from the wind to battery project," *IEEE Trans. Power Syst.*, vol. 28, no. 1, pp. 532–541, Feb. 2013.
- [123] S. Niaz, T. Manzoor, and A. H. Pandith, "Hydrogen storage: Materials, methods and perspectives," *Renew. Sustain. Energy Rev.*, vol. 50, pp. 457–469, Oct. 2015.
- [124] D. Linden and T. B. Reddy, *Handbook of Batteries*, 3rd ed. New York, NY, USA: McGraw-Hill, 2001.
- [125] R. Bhandari, C. A. Trudewind, and P. Zapp, "Life cycle assessment of hydrogen production via electrolysis—A review," *J. Cleaner Prod.*, vol. 85, pp. 151–163, Dec. 2014.
- [126] D. Bessarabov, H. Wang, H. Li, and N. Zhao, *PEM Electrolysis for Hydrogen Production: Principles and Applications*. Boca Raton, FL, USA: CRC Press, 2015.
- [127] Q. Cai, C. S. Adjiman, and N. P. Brandon, "Optimal control strategies for hydrogen production when coupling solid oxide electrolyzers with intermittent renewable energies," *J. Power Sources*, vol. 268, pp. 212–224, Dec. 2014.
- [128] S. E. Hosseini and M. A. Wahid, "Hydrogen production from renewable and sustainable energy resources: Promising green energy carrier for clean development," *Renew. Sustain. Energy Rev.*, vol. 57, pp. 850–866, May 2016.
- [129] P. Bajpai and V. Dash, "Hybrid renewable energy systems for power generation in stand-alone applications: A review," *Renew. Sustain. Energy Rev.*, vol. 16, no. 5, pp. 2926–2939, 2012.
- [130] J. M. Crider and S. D. Sudhoff, "Reducing impact of pulsed power loads on microgrid power systems," *IEEE Trans. Smart Grid*, vol. 1, no. 3, pp. 270–277, Dec. 2010.
- [131] M. Farhadi and O. Mohammed, "Energy storage technologies for high-power applications," *IEEE Trans. Ind. Appl.*, vol. 52, no. 3, pp. 1953–1961, May/June 2016.
- [132] I. S. Martín, A. Ursúa, and P. Sanchis, "Integration of fuel cells and supercapacitors in electrical microgrids: Analysis, modelling and experimental validation," *Int. J. Hydrogen Energy*, vol. 38, no. 27, pp. 11655–11671, Sep. 2013.
- [133] H. F. Habib, A. A. S. Mohamed, M. El Hariri, and O. A. Mohammed, "Utilizing supercapacitors for resiliency enhancements and adaptive microgrid protection against communication failures," *Electr. Power Syst. Res.*, vol. 145, pp. 223–233, Apr. 2017.
- [134] X. Zhang, Z. Zhang, H. Pan, W. Salman, Y. Yuan, and Y. Liu, "A portable high-efficiency electromagnetic energy harvesting system using supercapacitors for renewable energy applications in railroads," *Energy Convers. Manage.*, vol. 118, pp. 287–294, Jun. 2016.
- [135] D. P. Dubal, O. Ayyad, V. Ruiz, and P. Gómez-Romero, "Hybrid energy storage: The merging of battery and supercapacitor chemistries," *Chem. Soc. Rev.*, vol. 44, no. 7, pp. 1777–1790, 2015.
- [136] Q. Liu, M. H. Nayfeh, and S.-T. Yau, "Supercapacitor electrodes based on polyaniline-silicon nanoparticle composite," *J. Power Sources*, vol. 195, no. 12, pp. 3956–3959, 2010.
- [137] H. A. Kiehne, *Battery Technology Handbook*, 2nd ed. New York, NY, USA: CRC Press, Aug. 2003, pp. 1–542.
- [138] K. Gong, J. Shi, Y. Liu, Z. Wang, L. Ren, and Y. Zhang, "Application of SMES in the microgrid based on fuzzy control," *IEEE Trans. Appl. Supercond.*, vol. 26, no. 3, pp. 1–5, Apr. 2016.
- [139] M. G. Molina and P. E. Mercado, "Power flow stabilization and control of microgrid with wind generation by superconducting magnetic energy storage," *IEEE Trans. Power Electron.*, vol. 26, no. 6, pp. 910–922, Mar. 2011.
- [140] A. V. Pan, L. MacDonald, H. Baiej, and P. Cooper, "Theoretical consideration of superconducting coils for compact superconducting magnetic energy storage systems," *IEEE Trans. Appl. Supercond.*, vol. 26, no. 3, Apr. 2016, Art. no. 5700905.
- [141] H. Singh, "Thermal energy storage market by technology, storage material, application, end-user, and region—Global forecast to 2022," Pune, India, Tech. Rep. EP 5089, 2017.
- [142] U. Pelay, L. Luo, Y. Fan, D. Stitou, and M. Rood, "Thermal energy storage systems for concentrated solar power plants," *Renew. Sustain. Energy Rev.*, vol. 79, pp. 82–100, Nov. 2017.
- [143] A. Sharma, V. V. Tyagi, C. R. Chen, and D. Buddhi, "Review on thermal energy storage with phase change materials and applications," *Renew. Sustain. Energy Rev.*, vol. 13, no. 2, pp. 318–345, Feb. 2009.
- [144] M. Medrano, A. Gil, I. Martorell, X. Potau, and L. F. Cabeza, "State of the art on high-temperature thermal energy storage for power generation. Part 2—Case studies," *Renew. Sustain. Energy Rev.*, vol. 14, pp. 56–72, Jan. 2010.
- [145] N. Pfeleger, T. Bauer, C. Martin, M. Eck, and A. Wörner, "Thermal energy storage—Overview and specific insight into nitrate salts for sensible and latent heat storage," *Beilstein J. Nanotechnol.*, vol. 6, pp. 1487–1497, Jul. 2015.
- [146] M. B. A. Aziz, Z. M. Zain, S. R. M. S. Baki, and M. N. Muslam, "Review on performance of thermal energy storage system at S & T complex, UiTM Shah Alam, Selangor," in *Proc. IEEE Control Syst. Graduate Res. Colloq. (ICSGRC)*, Jun. 2010, pp. 49–54.
- [147] R. Carnegie, D. Gotham, D. Nderitu, and P. V. Preckel, *Utility Scale Energy Storage Systems: Benefits, Applications, and Technologies*. West Lafayette, IN, USA: Purdue Univ. Discovery Park-State Utility Forecasting Group, 2013, p. 95.
- [148] R. Hemmati and H. Saboori, "Emergence of hybrid energy storage systems in renewable energy and transport applications—A review," *Renew. Sustain. Energy Rev.*, vol. 65, pp. 11–23, Nov. 2016.
- [149] A. Etxeberria, I. Vechiu, H. Camblong, and J.-M. Vinassa, "Comparison of three topologies and controls of a hybrid energy storage system for microgrids," *Energy Convers. Manage.*, vol. 54, no. 1, pp. 113–121, Feb. 2012.
- [150] J. Li et al., "A novel use of the hybrid energy storage system for primary frequency control in a microgrid," *Energy Procedia*, vol. 103, pp. 82–87, Dec. 2016.
- [151] M. Althubaiti, M. Bernard, and P. Musilek, "Fuzzy logic controller for hybrid renewable energy system with multiple types of storage," May 2017, pp. 1–6.
- [152] J. Li, A. M. Gee, M. Zhang, and W. Yuan, "Analysis of battery lifetime extension in a SMES-battery hybrid energy storage system using a novel battery lifetime model," *Energy*, vol. 86, pp. 175–185, Jun. 2015.
- [153] T. Ise, M. Kita, and A. Taguchi, "A hybrid energy storage with a SMES and secondary battery," *IEEE Trans. Appl. Supercond.*, vol. 15, no. 2, pp. 1915–1918, Jun. 2005.

- [154] J. Li, M. Zhang, Q. Yang, Z. Zhang, and W. Yuan, "SMES/battery hybrid energy storage system for electric buses," *IEEE Trans. Appl. Supercond.*, vol. 26, no. 4, Jun. 2016, Art. no. 5700305.
- [155] D. MacKay and N. Winsor, "The future role for energy storage in the UK main report," Energy Res. Partnership, London, U.K., Tech. Rep. 52990, Jun. 2011.
- [156] Q. I. Yan, Q. U. Bo, Y. Jingjie, M. U. Yunfei, and G. Bingqing, "Frequency control strategy of hybrid energy storage system for micro-grid based on frequency hysteretic loop," *Energy Procedia*, vol. 103, pp. 328–332, Dec. 2016.
- [157] L. Jing, S. Yanxia, W. Dinghui, and Z. Zhipu, "A control strategy for islanded DC microgrid with battery/ultra-capacitor hybrid energy storage system," in *Proc. Chin. Control Decis. Conf. (CCDC)*, May 2016, pp. 6810–6813.
- [158] K. Nikhil and M. K. Mishra, "Application of hybrid energy storage system in a grid interactive microgrid environment," in *Proc. 41st Annu. Conf. IEEE Ind. Electron. Soc. (IECON)*, Nov. 2015, pp. 2980–2985.
- [159] J. Shen, S. Dusmez, and A. Khaligh, "Optimization of sizing and battery cycle life in battery/ultracapacitor hybrid energy storage systems for electric vehicle applications," *IEEE Trans. Ind. Informat.*, vol. 10, no. 4, pp. 2112–2121, Nov. 2014.
- [160] E. Karanasios, M. Ampatzis, P. H. Nguyen, W. L. Kling, and A. van Zwam, "A model for the estimation of the cost of use of Li-Ion batteries in residential storage applications integrated with PV panels," in *Proc. 49th Int. Univ. Power Eng. Conf. (UPEC)*, Sep. 2014, pp. 1–6.
- [161] S. Lichtner, R. Brindle, L. Kishter, and L. Pack, "Advanced materials and devices for stationary electrical energy storage applications," Dept. Energy, Washington, DC, USA, Tech. Rep. 12-30-10\_FINAL\_lowres, 2010.
- [162] G. Li et al., "Advanced intermediate temperature sodium–nickel chloride batteries with ultra-high energy density," *Nat. Commun.*, vol. 7, pp. 1–6, Feb. 2016.
- [163] J. M. Guerrero, M. Chandorkar, T.-L. Lee, and P. C. Loh, "Advanced control architectures for intelligent microgrids—Part I: Decentralized and hierarchical control," *IEEE Trans. Ind. Electron.*, vol. 60, no. 4, pp. 1254–1262, Apr. 2013.
- [164] P. Lin, P. Wang, J. Xiao, J. Wang, C. Jin, and Y. Tang, "An integral droop for transient power allocation and output impedance shaping of hybrid energy storage system in DC microgrid," *IEEE Trans. Power Electron.*, vol. 33, no. 7, pp. 6262–6277, Jul. 2017.
- [165] W. Jiang, L. Zhang, H. Zhao, R. Hu, and H. Huang, "Research on power sharing strategy of hybrid energy storage system in photovoltaic power station based on multi-objective optimisation," *IET Renew. Power Gener.*, vol. 10, no. 5, pp. 575–583, 2016.
- [166] K. van Berkel, S. Rullens, T. Hofman, B. Vroemen, and M. Steinbuch, "Topology and flywheel size optimization for mechanical hybrid powertrains," *IEEE Trans. Veh. Technol.*, vol. 63, no. 9, pp. 4192–4205, Nov. 2014.
- [167] W. Jing, C. H. Lai, W. S. H. Wong, and M. L. D. Wong, "Cost analysis of battery-supercapacitor hybrid energy storage system for standalone PV systems," in *Proc. 4th IET Clean Energy Technol. Conf. (CEAT)*, Nov. 2016, pp. 1–6.
- [168] L. M. Halabi, S. Mekhilef, L. Olatomiwa, and J. Hazelton, "Performance analysis of hybrid PV/diesel/battery system using HOMER: A case study Sabah, Malaysia," *Energy Convers. Manage.*, vol. 144, pp. 322–339, Jul. 2017.
- [169] M. Lippert, "Li-ion energy storage takes microgrids to the next level," *Renew. Energy Focus*, vol. 17, no. 4, pp. 159–161, 2016.
- [170] B. Zakeri and S. Syri, "Electrical energy storage systems: A comparative life cycle cost analysis," *Renew. Sustain. Energy Rev.*, vol. 42, pp. 569–596, Feb. 2015.
- [171] C. Spanos, D. E. Turney, and V. Fthenakis, "Life-cycle analysis of flow-assisted nickel zinc-, manganese dioxide-, and valve-regulated lead-acid batteries designed for demand-charge reduction," *Renew. Sustain. Energy Rev.*, vol. 43, pp. 478–494, Mar. 2015.
- [172] R. Xiong, J. Cao, Q. Yu, H. He, and F. Sun, "Critical review on the battery state of charge estimation methods for electric vehicles," *IEEE Access*, vol. 6, pp. 1832–1843, Dec. 2017.



**MOHAMMAD FAISAL** received the B.Sc. degree in electrical and electronic engineering from the Chittagong University of Engineering and Technology, Chittagong, Bangladesh, in 2010. He is currently pursuing the M.Sc. degree from Universiti Tenaga Nasional, Malaysia. He was appointed as a Lecturer at International Islamic University Chittagong, Bangladesh, in 2010, where he is currently an Assistant Professor. His research interests include power electronics and power system, energy storage systems, energy management, and intelligent controller.



**MAHAMMAD A. HANNAN** (M'10–SM'17) received the B.Sc. degree in electrical and electronic engineering from the Chittagong University of Engineering and Technology, Chittagong, Bangladesh, in 1990, and the M.Sc. and Ph.D. degrees in electrical, electronic, and systems engineering from Universiti Kebangsaan Malaysia, Bangi, Malaysia, in 2003 and 2007, respectively. He is currently a Professor of intelligent systems with the Department of Electrical Power Engineering, College of Engineering, Universiti Tenaga Nasional, Malaysia. He is also an Associate Editor of the IEEE ACCESS. He received numbers of gold awards for his innovative research in ITEX, MTE, INNOFEST, SIIF, and PERINTIS. His research interests include intelligent controllers, power electronics, hybrid vehicles, energy storage systems, image and signal processing, and artificial intelligence.



**PIN JERN KER** received the B.Eng. degree (Hons.) in electrical and electronic engineering from Universiti Tenaga Nasional (UNITEN), Malaysia, in 2009, and the Ph.D. degree in electronic and electrical engineering from The University of Sheffield, U.K. He is currently a Senior Lecturer with the Department of Electrical Power Engineering, UNITEN. He is also the Head of Unit (Electronics and IT) at the Institute of Power Engineering, a research institute of UNITEN. His research interests include the simulation and characterization of photodetectors, optical sensing, design of monitoring and control system for energy-related applications.



**AINI HUSSAIN** (M'98) received the B.Sc. degree in electrical engineering from Louisiana State University, USA, the M.Sc. degree from UMIST, U.K., and the Ph.D. degree from Universiti Kebangsaan Malaysia. She is currently a Professor with the Centre for Integrated Systems Engineering and Advanced Technologies, Faculty of Engineering and Built Environment, Universiti Kebangsaan Malaysia. Her research interests include decision support systems, machine learning, pattern recognition, and signal and image processing.



**MUHAMAD BIN MANSOR** received the B.Sc. degree in electrical engineering from Universiti Teknologi Malaysia, in 2000, the M.Sc. degree in electrical power engineering from Universiti Tenaga Nasional in 2006, and the Ph.D. degree in power electronics from Universiti Malaya in 2012. He is currently an Associate Professor and the Head of the Department of Electrical Power Engineering, College of Engineering, Universiti Tenaga Nasional. His research interests include power electronics, converter controller, and railway engineering.



**FREDE BLAABJERG** (S'86–M'88–SM'97–F'03) received the Ph.D. degree in power electronics from Aalborg University, Aalborg, Denmark. He was with ABB-Scandia, Randers, Denmark, from 1987 to 1988. He is currently a Professor with Aalborg University, Denmark. His current research interests include power electronics and its applications, such as in wind turbines, PV systems, reliability, harmonics and adjustable speed drives. He received the 18 IEEE Prize Paper Awards, the IEEE PELS Distinguished Service Award in 2009, the EPE-PEMC Council Award in 2010, the IEEE William E. Newell Power Electronics Award in 2014, and the Villum Kann Rasmussen Research Award in 2014. He was the Editor-in-Chief of the IEEE TRANSACTIONS ON POWER ELECTRONICS from 2006 to 2012. He was nominated in 2014, 2015, and 2016 by Thomson Reuters to be between the most 250 cited researchers in engineering in the world.

• • •