

Received May 18, 2016, accepted June 8, 2016, date of publication July 15, 2016, date of current version September 16, 2016.

Digital Object Identifier 10.1109/ACCESS.2016.2591954

Energy-Efficiency of Millimeter-Wave Full-Duplex Relaying Systems: Challenges and Solutions

ZHONGXIANG WEI¹, (Student Member, IEEE), XU ZHU¹, (Senior Member, IEEE),
SUMEI SUN², (Fellow, IEEE), YI HUANG¹, (Senior Member, IEEE),
AHMED AL-TAHMEESSCHI¹, AND YUFEI JIANG³, (Member, IEEE)

¹Department of Electrical Engineering and Electronics, University of Liverpool, Liverpool L69 3GJ, U.K.

²Institute for Infocomm Research, Agency for Science, Technology and Research, Singapore 138632

³Institute for Digital Communications, The University of Edinburgh, Edinburgh EH8 9YL, U.K.

Corresponding author: X. Zhu (xuzhu@liverpool.ac.uk)

ABSTRACT Full-duplex (FD) relaying is a promising solution for fifth generation (5G) wireless communications due to its potential to provide high spectral efficiency (SE) transmission. However, FD relay nodes consume much higher power than half-duplex relay nodes, especially in millimeter (mm)-wave band. Therefore, energy-efficiency (EE) is an important issue to address for mm-wave FD relaying systems, which highlights the green evolution of 5G wireless communications. Existing FD relaying related research is SE-oriented, which is not efficient in cutting carbon footprint. This article is different in that it addresses the critical EE challenges in implementing FD relaying in mm-wave systems, including low drain efficiency of power amplifier, high circuit power consumption, and additional power required by FD relays to mitigate self-interference. Based on the features of mm-wave communications, we outline a number of promising EE-oriented solutions for designing FD relaying enabled systems, including adaptive self-interference cancellation, transmission power adaptation, hybrid relaying mode selection, multi-input-multi-output (MIMO), and massive MIMO FD relaying. Some EE-oriented future research is also envisaged for mm-wave FD relaying systems.

INDEX TERMS Energy efficiency, millimeter-wave communication, relay, optimization.

I. INTRODUCTION

Fifth generation (5G) wireless communication systems are calling for significantly increased data rate (up to 1000 times higher than current data rate) for much richer multimedia applications, *e.g.*, high definition video and 3-D on-line games [1]. To achieve the Gbps-level data rate requirement, using the millimeter (mm)-wave band, *e.g.*, frequencies of 28 GHz, 38 GHz and 60 GHz, is a promising solution [2]. With the recent advance of circuit design for mm-wave band [3]–[6], there have been growing interests in standardizing its use for 5G communications. Besides, the mm level wavelength enables the creation of small-sized antennas and other radio hardware. Some advanced techniques, such as multiple-input multiple-output (MIMO) can be fabricated in the state-of-the-art small-sized terminals.

The mm-wave communication systems, however, have inherent disadvantages in that the propagation loss (PL) is high at such high frequency and that the signal can be easily blocked by obstacles due to short signal wavelength (only 5 mm at a frequency of 60 GHz) [7]. To alleviate the high PL

and the serious intermittent blockage effect, it is beneficial to employ relay nodes between sources and destinations to assist communications [8]. Conventional relaying systems, where sources communicate with destinations via relays, operate in half-duplex (HD) mode [9], *i.e.*, relays receive and transmit signal in orthogonal time slots. This leads to reduction of spectral efficiency (SE). Recently, full-duplex (FD) relaying technique [10] has attracted much attention due to its ability to achieve higher SE. An FD relay can receive and transmit signal simultaneously at the same frequency, which enables significant throughput improvement over existing HD relaying systems. However, strong self-interference is introduced at FD relay's receiver from its transmitter and effective self-interference cancellation is required at FD relay. Thanks to recent advance in self-interference cancellation, self-interference cancellation amount of up to 100 dB can be achieved [11]. With recent advance in self-interference cancellation and hardware designs, FD is also considered in mm-wave communications for high-speed and low-latency transmission. A 60 GHz transceiver with FD fiber-optic

transmit and receive chains was developed for short-range broadband application in [12], while FD implementation in millimeter/sub-millimeter Si-constructed chips was investigated in [13] and [14]. In mm-wave FD systems, as much as 80 – 100 dB of self-interference cancellation can be achieved by using passive suppression (PS), analog cancellation (AC) and digital cancellation (DC) [15], [16]. Also, benefiting from mm-wave transmission, PS at mm-wave frequency is naturally higher than that at low frequency, e.g., 2.4/5 GHz, which was also featured in [7].

On the other hand, high power consumption is a critical challenge in applying mm-wave FD relaying, because additional power is triggered by self-interference cancellation at FD relay [8]. Moreover, the receive and transmit chains of FD relaying systems are active at all time, while only one transmit chain or one receive chain of HD relaying is active at each time slot [17]. To address the high power consumption issue and achieve green communication, energy-efficiency (EE) is an important system performance metric proposed in 5G communication systems. However, to the best of our knowledge, there lacks investigation of EE of mm-wave FD relaying systems. This motivates the work demonstrated in this article:

1) Based on the features of mm-wave communication systems, we survey the critical EE challenges in deploying FD relaying technique at mm-wave frequency, such as low drain efficiency (DE) of power amplifier (PA), high circuit power consumption at mm-wave frequency and additional power required by self-interference cancellation. Besides, different self-interference cancellation schemes, including PS, AC and DC are summarized from the perspective of EE.

2) EE-oriented solutions are discussed specifically for mm-wave FD relaying communications, including adaptive self-interference cancellation, transmission power adaptation, hybrid relaying mode selection, MIMO and massive MIMO FD relaying.

3) The classifications of FD relaying systems are discussed according to different configurations, e.g., relaying mode, antenna type, numbers of relays and users and transmission directionality. Some mimicking FD relaying systems by HD relays are also demonstrated.

4) Some potential research on EE-oriented mm-wave FD systems are outlined, including FD distributed antenna systems, EE-oriented cross-layer resource allocation in multi-carrier scenarios and FD in mm-wave ultra-dense small cell networks.

II. OVERVIEW OF FD RELAYING

In this section, FD relaying classifications and mimicking FD relaying by HD relays are discussed, and then self-interference suppression/cancellation schemes for FD relaying are described.

A. FD RELAYING CLASSIFICATIONS

FD relaying systems can be classified in different ways as follows. Hereby, we take a two-hop FD relaying system in

the downlink as an example, which can be easily extended to a general multi-hop scenario.

1) BY RELAYING MODE

Based on the relaying mode, FD relaying systems can be divided into amplify-and-forward (AF) relaying systems and decode-and-forward (DF) relaying systems [8], [9].

An AF relay amplifies the received signal from source and forwards it, including the desired signal, noise, and residual self-interference, to destination. Therefore, AF relaying systems have simple circuit design and low power consumption. However, they introduce amplified noise and self-interference to destination.

A DF relay decodes the received signal first, and forwards the re-encoded signal to destination. Hence, the residual self-interference does not affect the link from relay to destination directly. However, a DF relay normally leads to higher power consumption and latency than an AF relay due to its complex signal processing.

2) BY ANTENNA TYPE AT RELAY

According to the type of antennas at relay, FD relaying systems can be classified as shared-antenna FD relaying [18] and separate-antenna FD relaying [9].

With shared-antenna, only one antenna set is adopted for both transmission and reception at relay node. A duplexer (circulator) is needed to route the received signal from antenna to the receive chain, and route the transmitted signal to the antenna from the transmit chain.

With separate-antenna, relay can use separate antennas for transmitting and receiving, respectively. In particular, separate-antenna is preferable when MIMO is applied at relay node. This is because the self-interference cancellation is more complex than in single-input single-output (SISO) systems, whereas the self-interference cancellation performance with the shared-antenna configuration is not optimal since the isolation offered by the duplexer is not sufficient.

3) BY NUMBERS OF RELAYS AND USERS

To combat the high PL and the blockage effect in mm-wave communications, a destination may be assisted by multiple relays [19]. In this case, one can apply relay selection to explore spatial diversity. Also, multiple users may be served by one relay node. In a multiuser scenario, multiple access technique, such as orthogonal frequency division duplexing access (OFDMA), can be adopted [9]. Importantly, the power of self-interference is different across subcarriers. To achieve a better self-interference cancellation performance, per-subcarrier self-interference cancellation [11] is desirable.

4) BY TRANSMISSION DIRECTIONALITY

According to the transmission directionality, FD relaying systems can be classified into one-way FD relaying and two-way FD relaying [20]. One-way FD relaying is involved with an FD relay receiving and transmitting in one direction.

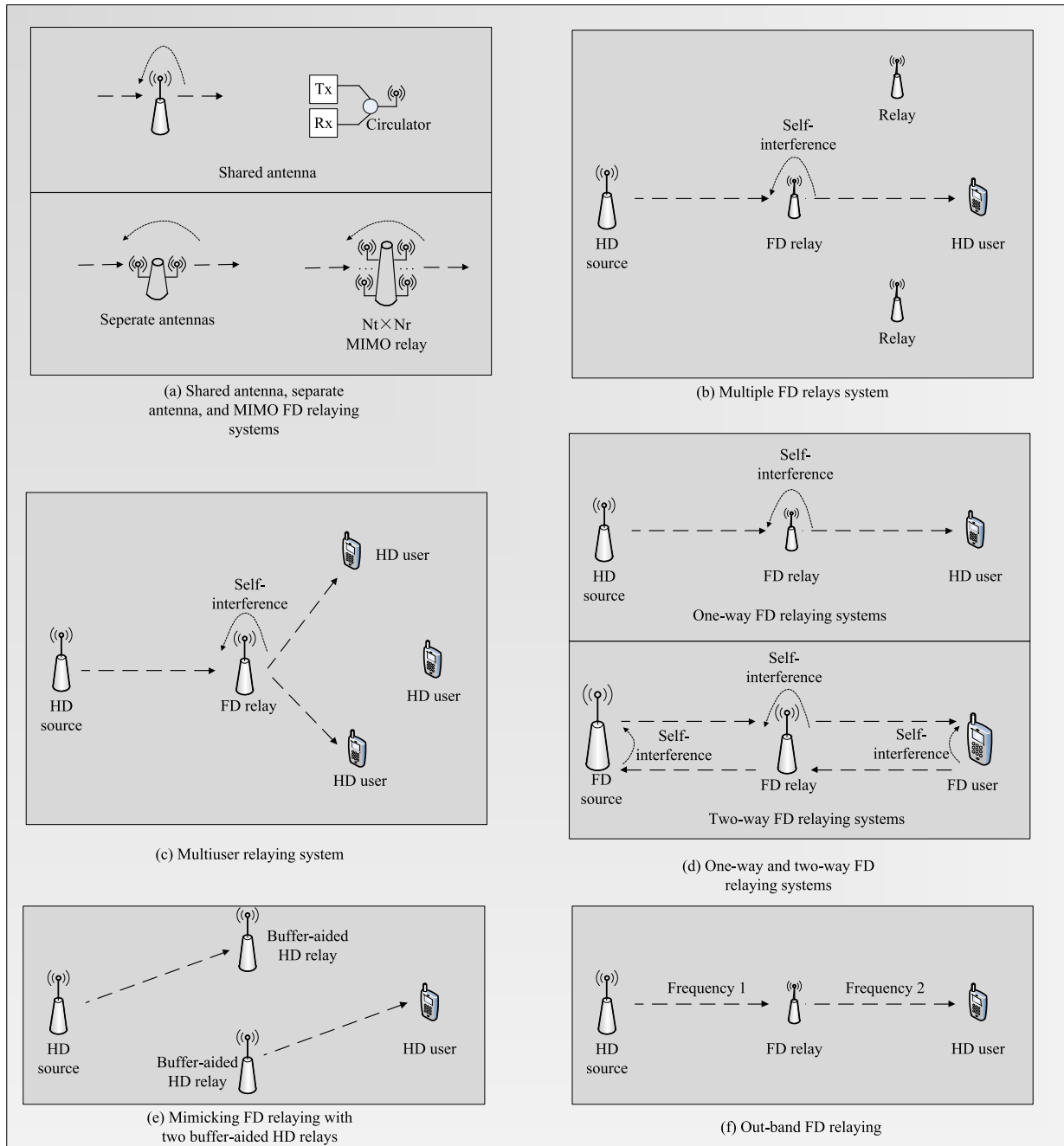

FIGURE 1. Classifications of FD relaying systems in the downlink and their mimics by HD relays.

While a two-way relaying system consists of two communication nodes, each operating in FD mode. The two nodes send signals to each other via the help of the FD relay node.

B. MIMICKING FD RELAYING BY HD RELAY

There are some schemes using HD relay to mimic FD relaying. One mimicking approach is to use two buffer-aided HD relays to cooperate communication between source and destination, where one relay is used to receive the signal from source and the other is used to transmit the buffered signal to

destination [21]. However, since two HD relays are needed at the same time, the associated power consumption is high.

Another mimicking approach is to let an HD relay node receive and transmit at different frequencies, which is referred to as the out-band FD relaying technique. However, SE is sacrificed in this case, since the frequency band is split into two orthogonal parts for transmission and reception individually.

The relaying modes summarized in Subsections II-A and II-B are illustrated in Fig. 1.

C. SELF-INTERFERENCE SUPPRESSION/CANCELLATION

Thanks to the recent advance in self-interference cancellation techniques [11], [17], [22], [23], the self-interference at FD relay can be mitigated effectively. There are three main approaches to mitigate self-interference at a relay node: PS, AC and DC [11].

1) PS

The first stage of self-interference cancellation, PS, mitigates self-interference in the propagation domain, via directional antenna, antenna placement and antenna shielding [23]. Recent research has shown that more than 70 dB of self-cancellation amount can be achieved by PS in an anechoic chamber, and more than 40 dB in a reflected room [24]. The advantage of using PS is that no additional power consumption is required. Fortunately, some features of mm-wave naturally benefit the performance of PS, e.g., the mm level wavelength and the application of directional antenna:

a) As discussed in Section I, mm level wavelength leads to a much higher PL, which can benefit self-interference mitigation in the propagation domain. For example, the distance between transmitter and receiver (separate antenna deployment) is 10 centimetre (cm) in a small-sized smart device. The resulting self-interference amount at 60 GHz is 20 dB lower than that at 5 GHz and 28 dB lower than that at 2.4 GHz, respectively, assuming the free space PL exponent [2]. Besides, for the mm level wavelength, a cm level absorptive obstacle between relay’s transmitter and receiver can block the direct path of self-interference effectively.

b) Besides, applying high-gain antennas with narrow beamwidth allows relay to steer beams to concentrate radiated energy in only the desired directions, and the transmitter

at relay can point to destination’s receiver. The main lobe of the beam of relay’s transmitter will not be routed into relay’s receiver. As a result, the self-interference comes only from reflected waves, which are much weaker than the direct path. Also, the application of directional antenna is beneficial to the cross-polarization, where transmit and receive antennas in orthogonal polarization states (vertically and horizontally polarized) can achieve a self-interference cancellation amount of around 20 dB. In summary, PS in mm-wave band can achieve much better performance than that in cm-wave band. PS implementation in mm-wave communication systems is illustrated in Fig. 2.

However, PS is sensitive to nearby environment, especially in reflective environment, and PS operation increases the frequency selectivity of the residual self-interference channel. To solve this problem, AC or/and DC can be used to mitigate residual self-interference further, where additional power consumption is required.

2) AC

After PS, self-interference can be further mitigated by AC before signal goes through low noise amplifiers (LNAs) [17], [25], [26]. With the ready-made transmit chains and receive chains, there are two kinds of AC designs: direct-conversion architecture AC and non-direct-conversion architecture AC, as illustrated in Fig. 3 (a) and (b), respectively. The former deploys direct-conversion radio architecture to estimate self-interference and subtracts it at relay’s receiver end. This kind of AC circuit design does not need additional baseband signal processing at relay node and thus consumes less power. Relay node processes the transmitted signal at transmitter to form the predicted self-interference in the analog-circuit domain. While the non-direct-conversion AC architecture generates

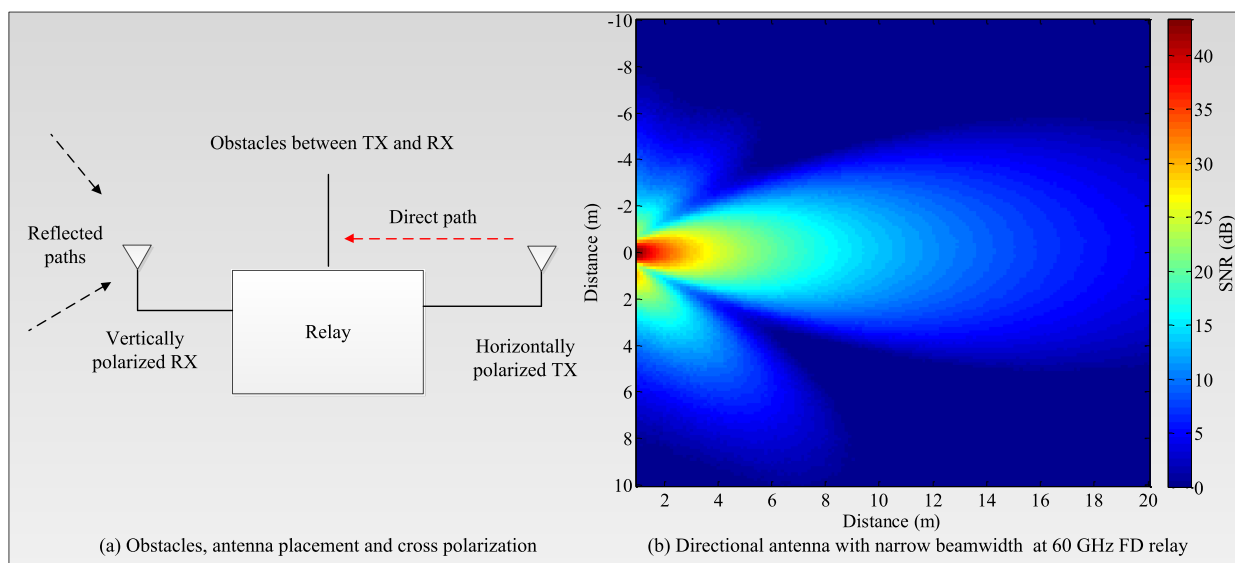

FIGURE 2. PS of self-interference in mm-wave FD relaying systems.

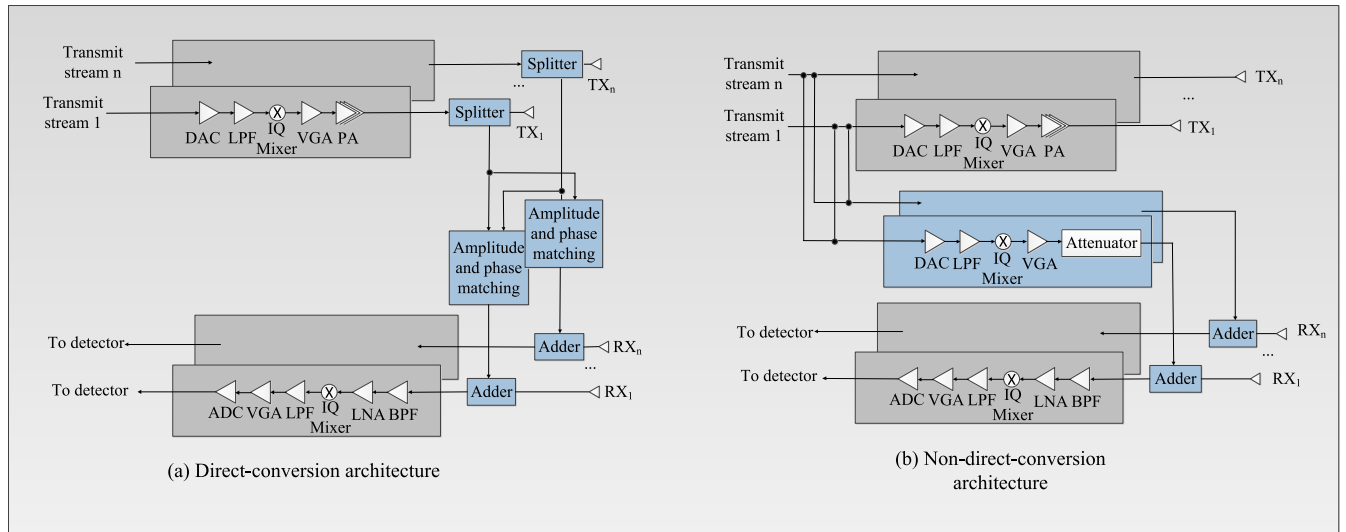

FIGURE 3. Direct-conversion and non-direct-conversion AC designs for self-interference cancellation.

the predicted self-interference by processing the transmit signal in digital domain, adjusts the gain/phase digitally, converts the digital signal to analog and finally feeds it to the receive chain for AC operation. Since baseband signal processing unit, digital-to-analogue converters (DACs), mixers, low pass filters (LPFs), attenuators and adders are required. The incurred power consumption is as high as the equivalent transmit chains.

3) DC

DC is applied at the last stage, which subtracts the residual self-interference after PS and AC in digital domain [22]. It requires accurate estimation of the residual self-interference following PS and AC. Moreover, the transmitter and receiver distortions need to be captured by DC. Therefore, complex baseband signal processing unit is required by DC operation, which consumes non-negligible power consumption.

III. POWER CONSUMPTION AND EE CHALLENGES IN mm-WAVE FD RELAYING SYSTEMS

In this section, we discuss the power consumption and the critical EE challenges of mm-wave FD relaying systems.

A. POWER CONSUMPTION OF mm-WAVE FD RELAYING SYSTEMS

1) POWER CONSUMPTION BY PA

For wireless communication systems operating at mm-wave frequency, the power consumed by cascaded PAs contributes a large portion to the total power consumption, which is mainly caused by the low DE. For example, the DE of current 60 GHz PAs is lower than 25% [4]. This is much lower than the DE of 2.4/5 GHz PAs, which is normally 30-40% [27], [28]. As a result, chips working in mm-wave

band dissipate much more power than the chips working in cm-wave band.

2) CIRCUIT POWER CONSUMPTION

Apart from PA power, circuit power also contributes a large part to the total power consumption. Limited by the start-of-the-art hardware design, circuit power consumed by a mm-wave chip is higher than that consumed by a cm-wave chip [3]. Generally, circuit power is the the power consumed by the signal processing parts, including LNAs, filters, DAC, analogue-to-digital converter (ADC), voltage controlled oscillator (VCO), dividers, local oscillator (LO) buffer, decoder, comparators, variable gain amplifier (VGA) etc, [3], which can be roughly divided into a static part and a dynamic part. The static power consumption is independent of the throughput, including the circuit power consumed by LNAs, VCO, dividers, LO buffer, etc, [29]. While the dynamic circuit power is closely related to the transmission status, which scales with the increase of throughput. For example, the decoding power boosts if throughput approaches the channel capacity as error probability approaches zero [30]. Especially for a DF relaying system, the decoding power is consumed at both relay node and destination.

3) ADDITIONAL POWER CONSUMPTION INCURRED BY FD TRANSMISSION

HD relaying splits the transmission into two orthogonal time slots, and only one receive chain or one transmit chain is active at each time slot. While in FD relaying systems, both transmit chain and receive chain are active at all time. Therefore, the power consumption of FD relaying is naturally higher than that of HD relaying.

The other additional power consumption of FD relay node is incurred by self-interference cancellation. Generally speaking, complex self-interference cancellation

scheme needs more involved components and consumes higher power. For example, the AC operation design in [11] needs DAC, transmit radio unit and adder to mitigate self-interference. The additional power consumption incurred by the self-interference cancellation is even comparable with the power consumption of the equivalent transmit chains [22]. Another kind of AC design in [17] uses tunable attenuation and delay unit to route the estimated signal to the receiver for self-interference cancellation. Attenuator, delay units and adders are required to adjust the delay and the amplitude, and the introduced power consumption is still non-negligible.

Besides, the power consumed by DC operation is also non-negligible. Since DC design needs to calculate the equivalent baseband signal after PS and AC operations, where digital baseband signal processing unit is required [11]. In conclusion, the self-interference cancellation brings critical EE challenges to FD relaying systems, as summarized in TABLE 1.

4) GENERAL TOTAL POWER CONSUMPTION FOR FD RELAYING SYSTEM

According to our analysis, the total power consumption generally includes the following parts: a) PA power consumption. b) Transmission state related (dynamic) circuit power consumption and transmission independent (static) circuit power consumption [31], [32]. c) Self-interference cancellation power consumption. Therefore, the total power consumption of FD relaying can be formulated as

$$P = \frac{P_s}{\omega} + \varepsilon T + P_{c,sta} + \xi_1 P_{AC} + \xi_2 P_{DC}, \quad (1)$$

where ω is DE of PA, P_s is transmission power, ε denotes the power consumption per unit throughput [33] and T denotes the throughput, $P_{c,sta}$, P_{AC} and P_{DC} represent the static circuit power consumption, the power consumption required by AC and DC operations. $\xi_1 = \{0, 1\}$, $\xi_2 = \{0, 1\}$ denote if AC or DC is applied (ξ_1 , or $\xi_2 = 1$) or not (ξ_1 , or $\xi_2 = 0$).

IV. EE-ORIENTED SOLUTIONS FOR mm-WAVE FD RELAYING SYSTEMS

In this section, we outline a number of EE-oriented solutions to implementing mm-wave FD relaying.

A. ADAPTIVE SELF-INTERFERENCE CANCELLATION

As discussed in Subsection II-C above, PS consumes no additional power and contributes a large portion of self-interference cancellation amount. Hence it is always implemented as the first stage for self-interference cancellation. However, if self-interference cancellation amount is not sufficient by PS, AC or/and DC are needed to mitigate self-interference further. LNAs at relay are placed at the front-end of relay's receiver to amplify the received signal. The effect of noise from subsequent stages (*e.g.*, noise introduced at the destination) is reduced by the gain of relay's LNAs. Therefore, high-gain LNA is preferred at relay (the noise figure is considered to be approximately irrelevant to the

power gain of LNA by good LNA design [8]). To let LNAs work with high gain, the power of self-interference should be strictly controlled before the received signal goes through LNAs, which can be done by AC rather than DC. Therefore, PS+AC can be adopted as another self-interference cancellation scheme. In some cases, given a poor AC performance, such as high radio frequency noise in AC operation [26], DC can be implemented as the third stage to mitigate self-interference in digital domain, at the expense of additional power consumption P_{DC} . The self-interference cancellation scheme in this case is PS+AC+DC.

EE η is defined as the ratio of throughput T to the incurred total power consumption P , *i.e.*, $\eta = \frac{T}{P}$ [33], [34]. Now, we compare the EE of FD with PS+AC and FD with PS+AC+DC as an example. Assume that the EE of FD with PS+AC is $\eta_{PSA} = \frac{T_{PSA}}{P_{PSA}}$, where T_{PSA} and P_{PSA} are the corresponding throughput and power consumption of FD with PS+AC. While define the EE of FD with PS+AC+DC is $\eta_{PSAD} = \frac{T_{PSAD}}{P_{PSAD}}$, where T_{PSAD} and P_{PSAD} are the corresponding throughput and power consumption of FD with PS+AC+DC. According to our analysis, the power consumption P_{PSA} can be approximately formulated as $P_{PSA} = \left(\frac{P_s}{\omega}\right) + \varepsilon T_{PSA} + P_{c,sta} + P_{AC}$, while the power consumption of P_{PSAD} is formulated as $P_{PSAD} = \left(\frac{P_s}{\omega}\right) + \varepsilon T_{PSAD} + P_{c,sta} + P_{AC} + P_{DC}$. Therefore, the EE difference between the FD with PS+AC and the FD with PS+AC+DC is calculated as

$$\eta_{PSA} - \eta_{PSAD} = \frac{T_{PSA}}{\frac{P_s}{\omega} + \varepsilon T_{PSA} + P_{c,sta} + P_{AC}} - \frac{T_{PSAD}}{\frac{P_s}{\omega} + \varepsilon T_{PSAD} + P_{c,sta} + P_{AC} + P_{DC}}. \quad (2)$$

(2) can be derived into

$$\eta_{PSA} - \eta_{PSAD} = \frac{P_{DC} - \left(\frac{P_s}{\omega} + P_{c,sta} + P_{AC}\right)\left(\frac{T_{PSAD}}{T_{PSA}} - 1\right)}{\frac{P_s}{\omega} + \varepsilon T_{PSA} + P_{c,sta} + P_{AC}} \times \frac{T_{PSA}}{\frac{P_s}{\omega} + \varepsilon T_{PSAD} + P_{c,sta} + P_{AC} + P_{DC}}. \quad (3)$$

Obviously, the sign of (3) is the same as the sign of its numerator. As can be seen from (3), term $\frac{T_{PSAD}}{T_{PSA}} - 1$ generally belongs to the region (0,1), since $2T_{PSA} > T_{PSAD} > T_{PSA}$. While $\frac{P_s}{\omega} + P_{c,sta} + P_{AC} > P_{DC}$ is readily lead. However, if the self-interference cancellation amount of DC is poor (leads to a small fraction of $\frac{T_{PSAD}}{T_{PSA}} - 1$) and circuit design of DC operation is complicated (leads to a high value of P_{DC}), the numerator of (3) may be larger than 0, indicating that FD with PS+AC is more EE than FD with PS+AC+DC. The theoretic analysis reveals the insight of dynamic self-interference cancellation, that adaptive self-interference cancellation addresses the state of residual self-interference level and the non-negligible power consumption of AC and DC operations. Similarly, comparison between

TABLE 1. Summary of different self-interference cancellation schemes for mm-wave fd relaying systems in terms of EE.

Self-interference cancellation schemes	Approaches	Additional power consumption	Features	Drawbacks
PS	Benefiting from high PL between relay's transmitter and receiver	Nil	Much higher PL than the PL with cm wave	Sensitive to environment; Increased frequency selectivity of self-interference channel
	Antenna shielding	Nil	Fully exploiting the advantage of mm level wavelength	Sensitive to environment; Increased frequency selectivity of self-interference channel
	Directional antenna	Nil	Widely used in mm-wave communications; Relay's transmitter pointing to destination with no direct self-interference	Sensitive to environment; Increased frequency selectivity of self-interference channel
AC	Direct-conversion architecture	Low	Aware to the reflected self-interference	Sensitive to wideband self-interference
	Non-Direct-conversion architecture	High	Unaware to the reflected self-interference	Not feasible in AF relaying system
DC	Digital-domain canceler	High	Inefficient given good performance by PS+AC, may degrade the EE performance	May cause negative effect to system (the introduced noise power is higher than the power of the self-interference canceled)

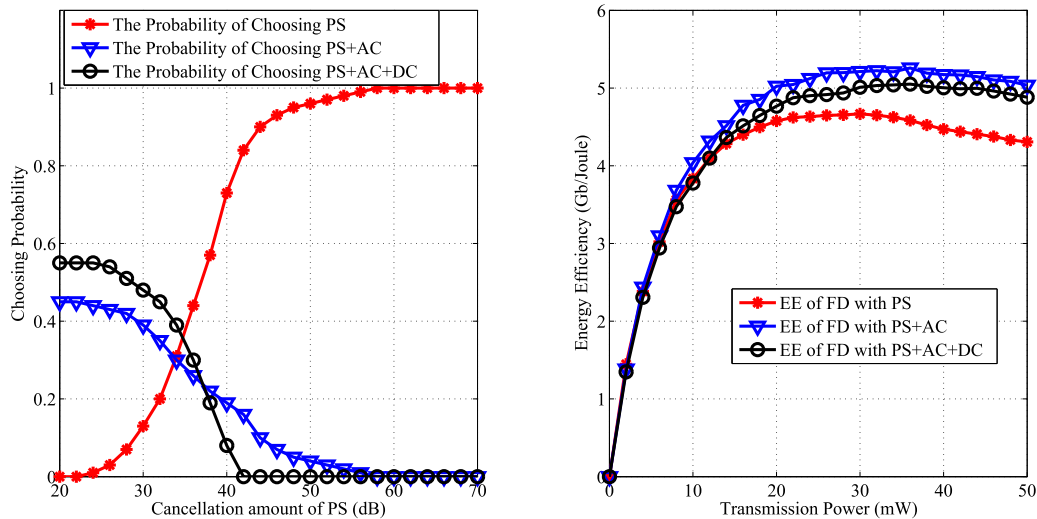

FIGURE 4. Performances of adaptive self-interference cancellation and EE-oriented transmission power adaptation in a 60 GHz FD AF relaying system, where $P_{c,sta} = 250$ mW, $\epsilon = 10$ mW/Gbs, $P_{AC} = 20$ mW and $P_{DC} = 30$ mW.

PS only and PS+AC, comparison between PS only and PS+AC+DC can be obtained.

Fig. 4 (a) demonstrates the probabilities of selecting among FD with PS only, FD with PS+AC and FD with PS+AC+DC. The amount of self-interference canceled by PS, α_{PS} , varies from 20~70 dB, as the performance of PS is sensitive to nearby environment, while the amount of self-interference cancellation by AC and DC are set to $\alpha_{AC} = 20$ dB and $\alpha_{DC} = 15$ dB, which are typical values of cancellation amounts by the state-of-the-art

AC and DC designs [11], [17]. With the increase of the value of α_{PS} , FD with PS has a higher chance of achieving a higher EE than FD with PS+AC and FD with PS+AC+DC. In this case, applying AC or/and DC leads to the decrease of EE, since the incurred power consumption by AC and DC increases the total power consumption. When the performance of PS is low, i.e., $\alpha_{PS} = 20 \sim 35$ dB, AC or/and DC need to be applied to mitigate self-interference further and higher EE can be achieved, even though additional power consumption is required.

B. TRANSMISSION POWER ADAPTATION

Transmission power adaptation is very important in EE-oriented design. Existing research on transmission power adaption for FD relaying systems focuses on SE maximization [9], [20], [35], [36], [37]. In SE-oriented designs, higher SE is pursued by fully utilizing the available transmission power. While for EE-oriented designs, utilizing high transmission power may degrade EE due to the increased total power consumption. Especially, given unsatisfactory self-interference cancellation performance, enhancing transmission power leads to stronger self-interference, and both SE and EE may be degraded by the ill-canceled self-interference. On the other hand, reducing transmission power at relay node can decrease the power of self-interference, whereas the reduced transmission power may affect reliable transmission from relay to destination. Therefore, the transmission power needs to be balanced carefully in FD relaying systems from the perspective of EE design. Generally, the EE of an FD relaying system is shown to be quasi-concave with respect to the transmission power [8], which means there is a optimal transmission power in terms of EE. Since the quasi-concavity indicates the existing of the global optimum, the optimal transmission power in terms of EE can be found by gradient-based search [38] or linear-based iterative search [39].

Fig. 4 (b) shows the EE performance with different values of transmission power at source in an AFFD relaying system, where PS only, PS+AC and PS+AC+DC are used to mitigate self-interference, respectively. As can be seen, higher transmission power does not ensure a higher EE, which is essentially different from the observation in an SE-oriented communication system. Also, EE performance is not optimal with a low transmission power, since the transmission rate is limited by the low transmission power, which leads to a poor EE performance.

C. HYBRID RELAYING MODE SELECTION

Relaying mode selection schemes have been given in [9] and [36] in terms of SE maximization. Based on EE-oriented design, relaying mode selection could be different.

1) HYBRID FD/HD RELAYING

One hybrid design focuses on FD/HD relaying switching [8]. The throughput of FD relaying can be at most twice as high as that of HD relaying (in case the residual self-interference can be neglected compared to the noise by the effective self-interference cancellation). However, an FD relay consumes more power than an HD relay. Therefore, the EE of an FD relaying system is not always higher than that of an HD relaying system, especially with poor self-interference cancellation. Besides, hybrid FD/HD relaying design can address the serious signal blockage problem in mm-wave communications. Due to serious signal blockage, FD relaying is not always feasible. In general, the BSs and relays are

deployed high, and the BS-relay link is usually blockage-free. While the relay-user link is often subject to blockage. In this case, keeping in FD mode may cause futile transmission and packet loss. Thus, relay can switch to HD mode to receive signal from BS continuously and save the received data in its buffer. Therefore, the blockage-aware FD/HD relaying can provide higher EE.

2) HYBRID AF/DF RELAYING

Apart from the hybrid FD/HD relaying mode selection, hybrid AF/DF FD relaying mode selection [9] can be considered as well. AF relaying consumes less power but suffers the amplification of noise and residual self-interference, resulting in a lower throughput than DF relaying. Therefore, AF or DF relay mode may be chosen over one another in terms of EE, given instantaneous channel state information.

D. MIMO FD RELAYING NETWORKS

It is known that MIMO can support higher throughput due to the enhanced transmit and receive diversities [22]. Hence, applying MIMO and beamforming in mm-wave FD relaying communications is considered to be a powerful approach to providing Gbps-level transmission rate. Also, with multiple transmit/receive antennas at the FD relay, additional spatial/multiplexing diversity can be obtained, which helps us mitigate self-interference and multiuser interference by using transmit/receive beamforming. By exploiting spatial/multiplexing diversity, the self-interference cancellation is referred to as spatial suppression [40]. With a large number of transmit/receive antennas at relay node, self-interference can be significantly reduced by spatial suppression [41].

1) JOINT AND SEPARATE BEAMFORMING DESIGN

In MIMO FD relaying networks, the beamforming design can be joint [40] or separate [39], [42], [43]. Generally, the joint beamforming design achieves better system performance. Since joint beamforming optimization considers transmit and receive beamforming together across several nodes within the whole network. However, joint beamforming requires much higher computational complexity and more overhead signaling. On the other hand, separate beamforming may be adopted to reduce the complexity, which optimizes only transmit or receive beamforming at one node or part of the whole network.

2) ONE DIRECTIONAL AND BI-DIRECTIONAL MIMO FD RELAYING

By the network structure, MIMO FD relaying can be classified into two categories. With HD eNB and HD users, the transmission directionality of MIMO FD relaying is one-way. The MIMO FD relay can assist the uplink and downlink transmission between HD eNB and HD users, where multiuser interference and self-interference can be mitigated by beamforming design. While with FD eNB and hybrid uplink/downlink users, the transmission directionality of MIMO FD relaying can be two-way. Different from

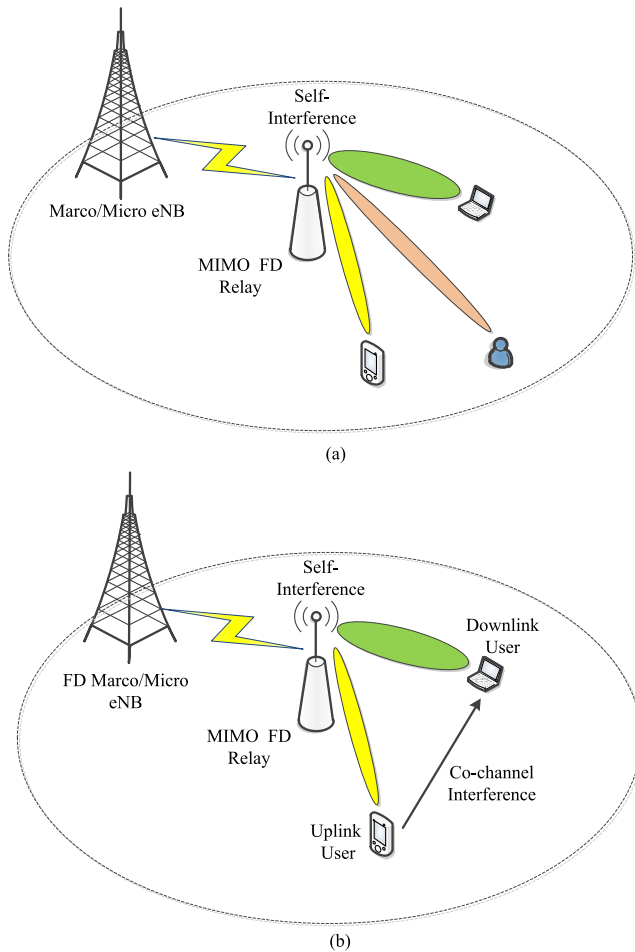

FIGURE 5. Illustration of MIMO/massive MIMO FD relaying networks. (a) Illustration of one directional, dual-hop MIMO FD relaying networks. (b) Illustration of bi-directional, dual-hop MIMO FD relaying networks, with hybrid users and FD macro/micro eNB.

multiuser interference and self-interference, co-channel interference (from uplink user to downlink user) can not be mitigated by MIMO and beamforming techniques at relay node. Therefore, the transmission power of uplink users needs

to be carefully controlled. The illustration of MIMO FD relaying networks is shown in Fig. 5.

3) EE-ORIENTED MIMO FD RELAYING DESIGN

All existing research on MIMO FD transmission focuses on SE maximization [9], [44], or outage probability minimization [37], [43], [45], or bit error rate minimization [40]. It is important to notice that MIMO relaying consumes much more power than SISO relaying, and therefore may render its EE performance. Since MIMO requires multiple transmit and receive antennas, there is a boost in circuit power compared to SISO. Also, MIMO FD relaying requires complicated self-interference cancellation, because the estimated self-interferences from different transmit antennas need to be routed to relay’s multiple receive chains, which is closely related to the beamformer design and the MIMO self-interference channel. Therefore, trade-off between EE and SE needs to be considered in MIMO FD relaying networks. One promising technique is transmit/receive antenna selection [46], [47], where one pair or part of receive/transmit antennas are selected for transmission and reception. With optimal antenna selection, the achievable SE can be close to that of MIMO transmission, while higher EE is achieved due to the power saving. The state-of-the-art research on MIMO FD transmission is summarized in TABLE 2.

E. MASSIVE MIMO FD RELAYING NETWORKS

Large-scale MIMO (L-MIMO or massive MIMO [48]) is an emerging wireless communication technique, that equips with hundreds of antennas and enables high SE. Massive MIMO networks offer the opportunity of increasing the SE (in terms of bits/s/Hz) by one or two orders of magnitude. This is possible with simple processing such as max-ratio-combining (MRC), zero-forcing (ZF) or minimum-mean-square-error (MMSE). In terms of SE maximization and spatial suppression [49]–[51], the advantage of massive MIMO is obvious. Since with the increased number of antennas for transmission and reception, the spatial diversity/multiplexing can be improved significantly, which can be

TABLE 2. Summary of MIMO FD relaying networks.

Reference	Precoding or decoding method used	Joint or separate beamforming design	Optimization metric	Antenna array
[9]	ZF	Joint	Throughput maximization	Co-located
[38]	ZF	Joint	Outage probability minimization	Co-located
[41]	MMSE	Separate	Bit error rate minimization	Co-located
[43]		Joint	Throughput maximization	Co-located
[40]	MMSE	Joint	Throughput maximization	Co-located
[44]	ZF	Joint	Outage probability minimization	Co-located
[45]	ZF	Separate	Throughput maximization	Co-located
[46]	ZF	Joint	Outage probability minimization	Co-located
[50]	ZF	Joint	Throughput maximization	Co-located
[51]	ZF	Separate	Self-interference cancellation maximization	Co-located

effectively used to improve SE and suppress the self-interference.

With the increased number of transmit/receive chains, however, AC and DC operations consume considerable power compared to SISO and conventional MIMO relaying. Besides, mm-level wavelength enables more small-sized antenna elements to be accommodated by an antenna array. In this case, how to guarantee enough natural isolation to facilitate the performance of PS is challenging. This is because, in practice, the dynamic range of the relay receiver circuitry is limited and high level of residual self-interference may saturate the receiver rendering the attempt to recover the desired signal.

V. POTENTIAL FUTURE RESEARCH

A. FD DISTRIBUTED ANTENNA SYSTEMS IN mm-WAVE BAND

For co-located antenna deployment, the small-fading can be effectively mitigated [2]. However, co-located antenna deployment has no advantage in mitigating the large-scale fading and limited ability in reducing the blockage effect, which are two characteristics in mm-wave band.

Differently, a distributed antenna (DA) system is implemented with multiple DAs located in different positions, such as coordinated multi-point (CoMP) and distributed radio remote unit (RRU) heads. Thus, DA systems can mitigate large-scale fading and obtain blockage-free effect using the antennas distributed geographically [52]. For FD DA systems, the self-interference between different DAs can be well controlled in the propagation domain and ideal natural isolation performance of PS is provided [53]. Besides, FD DA systems have advantages in EE design. For example, addressing the features of DA systems and the state-of-art switch on/off technique [34], the DAs far from users can be turned off to reduce power consumption and the complexity of self-interference cancellation. The illustration of FD DA systems is given in Fig. 6.

B. CROSS-LAYER RESOURCE ALLOCATION IN MULTI-CARRIER FD RELAYING mm-WAVE COMMUNICATIONS

To fully utilize the ultra-wide bandwidth of mm-wave band, multi-carrier technique needs to be adopted to combat frequency-selective fading. Since perfect self-interference cancellation at relay is impossible in practice, how to allocate subcarrier and power resources effectively is more challenging in FD relaying systems. Most existing research on resource allocation for multi-carrier FD relaying systems is SE-oriented [18], [22]. On the other hand, most existing research on FD relaying systems focuses on the physical (PHY) layer [35], [36], [44]. However, neighborhood loss and routing are important issues in mm-wave communications due to the high directionality transmission and blockage effect, which significantly affect the feasibility of FD transmission and the PHY layer design. To address the problem,

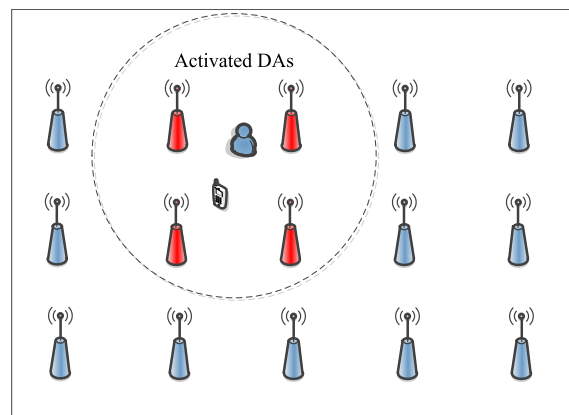

FIGURE 6. Illustration of FD DA system, with 4 activated DAs and 11 non-activated DAs.

cross-layer design is required, which should consider multiple layers jointly like the media access control (MAC) layer and the network layer. Besides, FD relaying is expected not to degrade the quality of service (QoS) in multiuser scenarios. In this case, how to incorporate FD relaying and meet the heterogeneous QoS requirements also needs to be addressed.

C. FD IN mm-WAVE ULTRA-DENSE SMALL CELL NETWORKS

To provide seamless coverage, the mm-wave ultra-dense small cell system is a promising characteristics of 5G systems [54], which acts as front/back haul for cellular networks. The small cell is formed by micro-, pico-, femto BS or relay node, which are featured by low cost and low power consumption. The small cell implementation has appeared to raise both SE and EE [55], [56]. Especially at mm-wave frequency, ultra-dense small cell communications plays an important role. The first reason is the low transmission power of chips working at mm-wave band. For example, the saturation output power of the state-of-the-art 60 GHz chips ranges from 10-15 dBm [3], while transmitters working at 2.4/5 GHz can provide a transmission power of above 25 dBm [27]. To satisfy the link budget, the cell size needs to be shrunk properly. The second reason is for alleviating the blockage effect. Since the mm level wavelength is very small (e.g., 5 mm for 60 GHz wave), links are easily blocked by any obstacle whose size is significantly larger than the signal wavelength, such as human body and furniture. Besides, combined with the mm-wave technique, ultra-dense small cell can provide more freedom for resource reusing.

FD transmission in mm-wave ultra-dense small cell networks has not been investigated. High density of small cell increases the possibility of inter-cell interference. The performance of FD transmission may be significantly degraded by noise, self-interference, inter-cell interference and multiuser interference. How to determine the density of small cell, how to organize adjacent small cells for cooperative communications and interference management are challenging.

The scenario of mm-wave ultra-dense small cell with FD transmission is illustrated in Fig. 7.

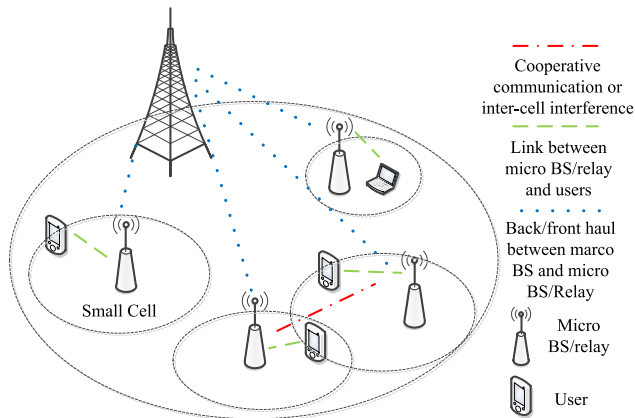

FIGURE 7. Mm-wave ultra-dense small cell networks with FD micro-, pico-, femto BS or relay.

VI. CONCLUSION

This article presents an overview of the challenges and solutions in terms of EE for mm-wave FD relaying systems. Different FD relaying classifications are discussed. The critical challenges related to the features of mm-wave FD relaying communications are demonstrated, including low DE of PA, high circuit power consumption and additional power by self-interference cancellation. We further outline, in detail, a number of technical solutions for enhancing EE of FD relaying systems, including adaptive self-interference cancellation, transmission power adaptation, hybrid relaying mode selection, MIMO and massive MMIO FD relaying. Finally, we envisage the EE-oriented future research for mm-wave FD relaying systems, including FD DA systems, EE-oriented cross-layer multi-carrier resource allocation and FD in mm-wave ultra-dense small cell networks.

REFERENCES

- [1] D. Sabella et al., "Energy efficiency benefits of RAN-as-a-service concept for a cloud-based 5G mobile network infrastructure," *IEEE Access*, vol. 2, pp. 1586–1597, 2014.
- [2] T. S. Rappaport, R. W. Heath, R. C. Daniels, and J. N. Murdock, *Millimeter Wave Wireless Communications*. Englewood Cliffs, NJ, USA: Prentice-Hall, 2015.
- [3] C. Marcu et al., "A 90 nm CMOS low-power 60 GHz transceiver with integrated baseband circuitry," *IEEE J. Solid-State Circuits*, vol. 44, no. 12, pp. 3434–3447, Dec. 2009.
- [4] A. Siligaris et al., "A 60 GHz power amplifier with 14.5 dBm saturation power and 25% peak PAE in CMOS 65 nm SOI," *IEEE J. Solid-State Circuits*, vol. 45, no. 7, pp. 1286–1294, Jul. 2010.
- [5] V.-H. Do, V. Subramanian, W. Keusgen, and G. Boeck, "A 60 GHz SiGe-HBT power amplifier with 20% PAE at 15 dBm output power," *IEEE Microw. Wireless Compon. Lett.*, vol. 18, no. 3, pp. 209–211, Mar. 2008.
- [6] K. Okada et al., "Full four-channel 6.3-Gb/s 60-GHz CMOS transceiver with low-power analog and digital baseband circuitry," *IEEE J. Solid-State Circuits*, vol. 48, no. 1, pp. 46–65, Jan. 2013.
- [7] S. Geng, J. Kivinen, X. Zhao, and P. Vainikainen, "Millimeter-wave propagation channel characterization for short-range wireless communications," *IEEE Trans. Veh. Technol.*, vol. 58, no. 1, pp. 3–13, Jan. 2009.
- [8] Z. Wei, X. Zhu, S. Sun, Y. Huang, L. Dong, and Y. Jiang, "Full-duplex versus half-duplex amplify-and-forward relaying: Which is more energy efficient in 60-GHz dual-hop indoor wireless systems?" *IEEE J. Sel. Areas Commun.*, vol. 33, no. 12, pp. 2936–2947, Dec. 2015.
- [9] D. W. K. Ng, E. S. Lo, and R. Schober, "Dynamic resource allocation in MIMO-OFDMA systems with full-duplex and hybrid relaying," *IEEE Trans. Commun.*, vol. 60, no. 5, pp. 1291–1304, May 2012.
- [10] A. Sahai, G. Patel, and A. Sabharwal. (Jul. 2011). "Pushing the limits of full-duplex: Design and real-time implementation." [Online]. Available: <https://arxiv.org/abs/1107.0607>
- [11] M. Duarte et al., "Design and characterization of a full-duplex multi-antenna system for WiFi networks," *IEEE Trans. Veh. Technol.*, vol. 63, no. 3, pp. 1160–1177, Mar. 2014.
- [12] S. T. Choi, K. S. Yang, S. Nishi, S. Shimizu, K. Tokuda, and Y. H. Kim, "A 60-GHz point-to-multipoint millimeter-wave fiber-radio communication system," *IEEE Trans. Microw. Theory Techn.*, vol. 54, no. 5, pp. 1953–1960, May 2006.
- [13] T. Dinc and H. Krishnaswamy, "A T/R antenna pair with polarization-based reconfigurable wideband self-interference cancellation for simultaneous transmit and receive," in *Proc. IEEE IMS*, Phoenix, AZ, USA, May 2015, pp. 1–4.
- [14] D.-J. van den Broek, E. A. M. Klumperink, and B. Nauta, "An in-band full-duplex radio receiver with a passive vector modulator downmixer for self-interference cancellation," *IEEE J. Solid-State Circuits*, vol. 50, no. 12, pp. 3003–3014, Dec. 2015.
- [15] L. Li, K. Josiam, and R. Taori, "Feasibility study on full-duplex wireless millimeter-wave systems," in *Proc. IEEE ICASSP*, Florence, Italy, May 2014, pp. 2769–2773.
- [16] V. V. Mai, J. Kim, S.-W. Jeon, S. W. Choi, B. Seo, and W.-Y. Shin, "Degrees of freedom of millimeter wave full-duplex systems with partial CSIT," *IEEE Commun. Lett.*, vol. 20, no. 5, pp. 1042–1045, May 2016.
- [17] M. Jain et al., "Practical, real-time, full duplex wireless," in *Proc. 17th ACM MobiCom*, New York, NY, USA, Sep. 2010, pp. 301–312.
- [18] H. Ju, E. Oh, and D. Hong, "Improving efficiency of resource usage in two-hop full duplex relay systems based on resource sharing and interference cancellation," *IEEE Trans. Wireless Commun.*, vol. 8, no. 8, pp. 3933–3938, Aug. 2009.
- [19] I. Krikidis, H. A. Suraweera, P. J. Smith, and C. Yuen, "Full-duplex relay selection for amplify-and-forward cooperative networks," *IEEE Trans. Wireless Commun.*, vol. 11, no. 12, pp. 4381–4393, Dec. 2012.
- [20] H. Cui, M. Ma, L. Song, and B. Jiao, "Relay selection for two-way full duplex relay networks with amplify-and-forward protocol," *IEEE Trans. Wireless Commun.*, vol. 13, no. 7, pp. 3768–3777, Jul. 2014.
- [21] A. Ikhlef, J. Kim, and R. Schober, "Mimicking full-duplex relaying using half-duplex relays with buffers," *IEEE Trans. Veh. Technol.*, vol. 61, no. 7, pp. 3025–3037, Sep. 2012.
- [22] S. Huberman and T. Le-Ngoc, "MIMO full-duplex precoding: A joint beamforming and self-interference cancellation structure," *IEEE Trans. Wireless Commun.*, vol. 14, no. 4, pp. 2205–2217, Apr. 2015.
- [23] D. Bharadia, E. McMillin, and S. Katti, "Full duplex radios," in *Proc. ACM SIGCOMM*, Hong Kong, Aug. 2013, pp. 375–386.
- [24] E. Everett, A. Sahai, and A. Sabharwal, "Passive self-interference suppression for full-duplex infrastructure nodes," *IEEE Trans. Wireless Commun.*, vol. 13, no. 2, pp. 680–694, Jan. 2014.
- [25] V. Syrjala, M. Valkama, L. Anttila, T. Riihonen, and D. Korpi, "Analysis of oscillator phase-noise effects on self-interference cancellation in full-duplex OFDM radio transceivers," *IEEE Trans. Wireless Commun.*, vol. 13, no. 6, pp. 2977–2990, Jun. 2014.
- [26] Z. He, S. Shao, Y. Shen, C. Qing, and Y. Tang, "Performance analysis of RF self-interference cancellation in full-duplex wireless communications," *IEEE Wireless Lett.*, vol. 3, no. 4, pp. 405–408, Aug. 2014.
- [27] B. François and P. Reynaert, "A fully integrated transformer-coupled power detector with 5 GHz RF PA for WLAN 802.11ac in 40 nm CMOS," *IEEE J. Solid-State Circuits*, vol. 50, no. 5, pp. 1237–1250, May 2015.
- [28] K. Yamamoto et al., "A 2.2-V operation, 2.4-GHz single-chip GaAs MMIC transceiver for wireless applications," *IEEE J. Solid-State Circuits*, vol. 34, no. 4, pp. 502–512, Apr. 1999.
- [29] EARTH Project. (Dec. 2010). *D2.3 Energy Efficiency Analysis of the Reference Systems, Areas of Improvements and Target Breakdown*. [Online]. Available: <http://www.ict-earth.eu/publications/publications.html>
- [30] P. Grover, K. Woyach, and A. Sahai, "Towards a communication-theoretic understanding of system-level power consumption," *IEEE J. Sel. Areas Commun.*, vol. 29, no. 8, pp. 1744–1755, Sep. 2011.

- [31] S. Cui, A. J. Goldsmith, and A. Bahai, "Energy-constrained modulation optimization," *IEEE Trans. Wireless Commun.*, vol. 4, no. 5, pp. 2349–2360, Sep. 2005.
- [32] S. Cui, A. J. Goldsmith, and A. Bahai, "Energy-efficiency of MIMO and cooperative MIMO techniques in sensor networks," *IEEE J. Sel. Areas Commun.*, vol. 22, no. 6, pp. 1089–1098, Aug. 2004.
- [33] C. Xiong, G. Y. Li, S. Zhang, Y. Chen, and S. Xu, "Energy- and spectral-efficiency tradeoff in downlink OFDMA networks," *IEEE Trans. Wireless Commun.*, vol. 10, no. 11, pp. 3874–3886, Nov. 2011.
- [34] R. Bolla, R. Bruschi, F. Davoli, and F. Cucchietti, "Energy efficiency in the future Internet: A survey of existing approaches and trends in energy-aware fixed network infrastructures," *IEEE Commun. Surveys Tuts.*, vol. 13, no. 2, pp. 223–244, 2nd Quart., 2011.
- [35] T. Riihonen, S. Werner, and R. Wichman, "Hybrid full-duplex/half-duplex relaying with transmit power adaptation," *IEEE Trans. Wireless Commun.*, vol. 10, no. 9, pp. 3074–3085, Sep. 2011.
- [36] T. Riihonen, S. Werner, and R. Wichman, "Optimized gain control for single-frequency relaying with loop interference," *IEEE Trans. Wireless Commun.*, vol. 8, no. 6, pp. 2801–2806, Jun. 2009.
- [37] H. A. Suraweera, I. Krikidis, G. Zheng, C. Yuen, and P. J. Smith, "Low-complexity end-to-end performance optimization in MIMO full-duplex relay systems," *IEEE Trans. Wireless Commun.*, vol. 13, no. 2, pp. 913–927, Feb. 2014.
- [38] C. Xiong, G. Y. Li, S. Zhang, Y. Chen, and S. Xu, "Energy-efficient resource allocation in OFDMA networks," *IEEE Trans. Commun.*, vol. 60, no. 12, pp. 3767–3778, Dec. 2012.
- [39] D. Nguyen, L.-N. Tran, P. Pirinen, and M. Latva-Aho, "On the spectral efficiency of full-duplex small cell wireless systems," *IEEE Trans. Wireless Commun.*, vol. 13, no. 9, pp. 4896–4910, Sep. 2014.
- [40] T. Riihonen, S. Werner, and R. Wichman, "Mitigation of loopback self-interference in full-duplex MIMO relays," *IEEE Trans. Signal Process.*, vol. 59, no. 12, pp. 5983–5993, Dec. 2011.
- [41] G. Liu, F. R. Yu, H. Ji, V. C. M. Leung, and X. Li, "In-band full-duplex relaying: A survey, research issues and challenges," *IEEE Commun. Surveys Tuts.*, vol. 17, no. 2, pp. 500–524, 2nd Quart., 2015.
- [42] B. P. Day, A. R. Margetts, D. W. Bliss, and P. Schniter, "Full-duplex MIMO relaying: Achievable rates under limited dynamic range," *IEEE J. Sel. Areas Commun.*, vol. 30, no. 8, pp. 1541–1553, Sep. 2012.
- [43] G. Amarasuriya, C. Tellambura, and M. Ardakani, "Two-way amplify-and-forward multiple-input multiple-output relay networks with antenna selection," *IEEE J. Sel. Areas Commun.*, vol. 30, no. 8, pp. 1513–1529, Sep. 2012.
- [44] J. H. Lee and O. S. Shin, "Full-duplex relay based on distributed beamforming in multiuser MIMO systems," *IEEE Trans. Veh. Technol.*, vol. 62, no. 4, pp. 1855–1860, May 2013.
- [45] G. Amarasuriya, C. Tellambura, and M. Ardakani, "Multi-way MIMO amplify-and-forward relay networks with zero-forcing transmission," *IEEE Trans. Commun.*, vol. 61, no. 12, pp. 4847–4863, Dec. 2013.
- [46] K. Yang, H. Cui, L. Song, and Y. Li, "Efficient full-duplex relaying with joint antenna-relay selection and self-interference suppression," *IEEE Trans. Wireless Commun.*, vol. 14, no. 7, pp. 3991–4005, Jul. 2015.
- [47] K. Yang, N. Yang, C. Xing, and J. Wu, "Relay antenna selection in MIMO two-way relay networks over Nakagami- m fading channels," *IEEE Trans. Veh. Technol.*, vol. 63, no. 5, pp. 2349–2362, Jun. 2014.
- [48] A. Sabharwal. (Nov. 2015). *Massive MIMO Full-Duplex: Theory and Experiments*. [Online]. Available: <http://circuit.ucsd.edu/~yhc/ece293-aut15/pdfs/aut15-sabharwal.pdf>
- [49] H. Q. Ngo, H. A. Suraweera, M. Matthaiou, and E. G. Larsson, "Multipair full-duplex relaying with massive arrays and linear processing," *IEEE J. Sel. Areas Commun.*, vol. 32, no. 9, pp. 1721–1737, Sep. 2014.
- [50] B. Yin, M. Wu, C. Studer, J. R. Cavallaro, and J. Lilleberg, "Full-duplex in large-scale wireless systems," in *Proc. ASILOMAR*, Pacific Grove, CA, USA, Nov. 2013, pp. 1623–1627.
- [51] X. Jia, P. Deng, L. Yang, and H. Zhu, "Spectrum and energy efficiencies for multiuser pairs massive MIMO systems with full-duplex amplify-and-forward relay," *IEEE Access*, vol. 3, pp. 1907–1918, 2015.
- [52] J. Joung, Y. K. Chia, and S. Sun, "Energy-efficient, large-scale distributed-antenna system (L-DAS) for multiple users," *IEEE J. Sel. Topics Signal Process.*, vol. 8, no. 5, pp. 954–965, Oct. 2014.
- [53] B. Li, D. Zhu, and P. Liang, "Small cell in-band wireless backhaul in massive MIMO systems: A cooperation of next-generation techniques," *IEEE Trans. Wireless Commun.*, vol. 14, no. 12, pp. 7057–7069, Dec. 2015.

- [54] S. F. Yunas, M. Valkama, and J. Niemelä, "Spectral and energy efficiency of ultra-dense networks under different deployment strategies," *IEEE Commun. Mag.*, vol. 53, no. 1, pp. 90–100, Jan. 2015.
- [55] C.-X. Wang et al., "Cellular architecture and key technologies for 5G wireless communication networks," *IEEE Commun. Mag.*, vol. 52, no. 2, pp. 122–130, Feb. 2014.
- [56] X. Ge, S. Tu, G. Mao, C.-X. Wang, and T. Han, "5G ultra-dense cellular networks," *IEEE Wireless Commun.*, vol. 23, no. 1, pp. 72–79, Feb. 2016.



algorithm design.



She is currently a Reader. She has authored over 120 peer-reviewed publications on communications and signal processing. She is an Editor of the IEEE TRANSACTIONS ON WIRELESS COMMUNICATIONS, and has served as a Guest Editor for several international journals. She is also a Symposium Chair of the IEEE ICC 2016, and the Vice Chair of the 2006 and 2008 ICARN International Workshops, the Program Chair of the ICSAI 2012, and the Publication Chair of the IEEE IUCC-2012 and IUCC-2014. Her research interests include MIMO, equalization, resource allocation, optimization, cognitive radio, and smart grid communications.



She is an inventor and a co-inventor of 30 granted patents and more than 30 pending patent applications, many of which have been licensed to industry. She has also been actively contributing to organizing conferences in different roles. Some of her recent conference services include the Executive Vice Chair of Globecom 2017, the Symposium Co-Chair of ICC 2015 and 2016, the Track Co-Chair of the IEEE VTC 2012 Spring, VTC 2014 Spring, and VTC 2016 Fall, the Publicity Co-Chair of PIMRC 2015. She is an Editor of the IEEE TRANSACTIONS ON VEHICULAR TECHNOLOGY (TVT) since 2011, an Editor of the IEEE WIRELESS COMMUNICATION LETTERS from 2011 to 2016, and an Editor of the IEEE Communications Surveys and Tutorials since 2015. She received the Top Editor Award in 2016, Top15 Outstanding Editors recognition in 2014, and Top Associate Editor recognition in 2013 and 2012, all from TVT. She is also a Distinguished Lecturer of the IEEE Vehicular Technology Society 2014–2016, a co-recipient of the 16th PIMRC Best Paper Award, and a Distinguished Visiting Fellow of the Royal Academy of Engineering, U.K., in 2014.

ZHONGXIANG WEI (S'15) received the M.S. degree in information and communication engineering from the Chongqing University of Posts and Telecommunications, Chongqing, China, in 2013. He is currently pursuing the Ph.D. degree with the Department of Electrical Engineering and Electronics, University of Liverpool, Liverpool, U.K. His research interests include green communications, full-duplex, millimeter-wave communications, resource allocation, and

XU ZHU (S'02–M'03–SM'12) received the B.Eng. degree (Hons.) in electronics and information engineering from the Huazhong University of Science and Technology, Wuhan, China, in 1999, and the Ph.D. degree in electrical and electronic engineering from the Hong Kong University of Science and Technology, Hong Kong, in 2003. Since 2003, she has been with the Department of Electrical Engineering and Electronics, University of Liverpool, Liverpool, U.K., where she is

SUMEI SUN (F'16) is currently the Head of the Cognitive Communications Technology Department, Institute for Infocomm Research, Agency for Science, Technology, and Research, Singapore. She has authored and co-authored over 200 technical papers in prestigious IEEE journals and conferences. Her research focus is energy- and spectrum-efficient communication technologies for connecting human, machines, and things. She is an inventor and a co-inventor of 30 granted



YI HUANG (S'91–M'96–SM'06) received the D.Phil. degree in communications from the University of Oxford, Oxford, U.K., in 1994. Since 1987, he has been conducting research in wireless communications, applied electromagnetics, radar, and antennas. His experience includes three years spent with NRIET (China) as a Radar Engineer and various periods with the Universities of Birmingham, Oxford, and Essex, U.K. He was a Research Fellow with British Telecom Labs

in 1994, and then joined the University of Liverpool, Liverpool, U.K., in 1995, where he is currently a Full Professor and the Deputy Head of the Department of Electrical Engineering and Electronics. He has authored over 300 refereed papers, received many research grants from various funding bodies, and acted as a Consultant for various companies. He has been a Keynote/Invited Speaker and Organizer of many conferences and workshops (e.g., WiCom2010, IEEE iWAT 2010, and LAPC2012). He is the Editor-in-Chief of the *Wireless Engineering and Technology* and has been an Editor or Guest Editor for four international journals. He is a U.K. national representative of the EU COST-IC1102 and an Executive Committee Member and a fellow of the IET.

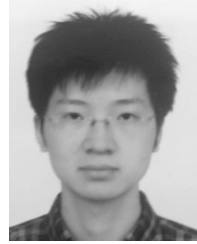

YUFEI JIANG (S'12–M'14) received the Ph.D. degree in wireless communications and signal processing from the University of Liverpool, Liverpool, U.K, in 2014. He has been a Post-Doctoral Researcher with the Department of Electrical and Electronic Engineering, University of Liverpool. His research interests include MIMO, CoMP communication, FD, OFDM, synchronization, and blind source separation.

...



AHMED AL-TAHMEESCHI received the B.Sc. and M.Sc. degrees in communications engineering from the University of Technology, Baghdad, Iraq. He is currently pursuing the Ph.D. degree with the Department of Electrical Engineering and Electronics, University of Liverpool, Liverpool, U.K. His research interests include cognitive radio networks and dynamic spectrum access techniques.