

Changes in the Efficiency of Photovoltaic Energy Conversion in Temperature Range With Extreme Limits

Martin Libra , Tomáš Petřík, Vladislav Poulek , *Member, IEEE*, Igor I. Tyukhov, and Pavel Kouřim

Abstract—The efficiency of the photovoltaic energy conversion depends on the temperature significantly. We monitored the behavior of I - V characteristics of the PV cell based on monocrystalline silicon in temperature range with extreme limits from -170 °C to $+100$ °C. We have not yet found a similar measurement in this temperature interval. The temperature of PV modules without radiation concentration can reach values of -100 °C to $+100$ °C on the Earth's surface. The temperature range may be few wider in space. Changes of I - V characteristics and P - V characteristics are discussed in terms of the theory of solids. The open-circuit voltage dependence is approximately linear over a wide temperature range, but saturation occurs at temperatures around -150 °C, which is also explained in accordance with the theory of semiconductors. The decrease in energy conversion efficiency with increasing temperature has a value of about $0.5\%/^{\circ}\text{C}$ throughout the whole temperature range possible on the Earth's surface. If there are large changes in the temperature of the PV modules during operation of the PV system, the electrical voltage of the PV modules will also change considerably. In space applications, these fluctuations may be greater. This must be taken into account when designing PV systems (especially for deep space missions). For example, electronic inverters are sensitive to overvoltage or undervoltage.

Index Terms—Efficiency, energy conversion, photovoltaics, solar energy.

NOMENCLATURE

I	Electric current.
I_{SC}	Short-circuit current.
V	Voltage.
V_D	Diffusion voltage.
V_P	Photovoltaic voltage.
V_{OC}	Open-circuit voltage.
\vec{E}	Electric field intensity.
I_T	Irradiation intensity.
t	Temperature.
E_F	Fermi energy level.

E_i	Center of the forbidden gap.
E_V	Valence band edge.
E_C	Conduction band edge.
ΔE_G	Forbidden gap.
E_D	Donor energy level.
E_A	Acceptor energy level.
N_D	Donor concentration.
N_A	Acceptor concentration.
ν	Frequency.

I. INTRODUCTION

THE efficiency of photovoltaic (PV) energy conversion is an important parameter of PV cells. The development of record efficiencies of PV cells was described in the article [1]. Other important parameters of PV cells also depend significantly on temperature [2], [3], [35]. This behavior is related to the theory of solids [4], [5]. Temperature changes cause changes in the Fermi energy level in the band structure of energy levels [6], [7]. As a result, both the open-circuit voltage and the electrical power supplied by the PV system will change [8]–[10]. The design of PV systems with concentrators of solar radiation can significantly increase the temperature of PV modules [11], [12]. This will, however, reduce the efficiency of PV energy conversion, and, therefore, the designer needs to look for an optimal balance between power increase due to higher intensity of concentrated radiation on PV modules and reduction of energy conversion efficiency due to higher temperature. Temperature of PV cells can also be influenced by the design of hybrid photovoltaic/photothermal (PV/PT) systems [13] or by design with passive cooling [14]. In particular, the usage of the vacuum layer as thermal insulation greatly increases the temperature of PV cells [15]. The dependence of the amount of electricity produced on the temperature of PV modules was monitored for example in the works [16], [17]. The PV modules built into the roof construction are less cooled than PV modules standing freely and therefore they produce less electricity. The temperature model of PV systems was also discussed in the works [18], [19]. The temperature has a major impact on the lifetime of the PV system, especially when batteries are incorporated into the PV module [20], [21]. PV degradation rate affected by different weather conditions was studied in the work [22].

In this article, results of temperature dependence measurements in a very wide temperature range from -170 °C to $+100$ °C are presented. We have not yet found a similar measurement in this temperature interval. In Central Europe, the temperature of the Earth's surface changes by up to 50 °C during the year, and in Central Siberia, for example, there are places

Manuscript received May 20, 2021; revised August 6, 2021; accepted August 24, 2021. Date of publication September 14, 2021; date of current version October 21, 2021. The work was supported by internal research project of the Faculty of Engineering under Grant IGA2021:31120/1312/3114. (*Corresponding author: Martin Libra.*)

Martin Libra, Tomáš Petřík, Vladislav Poulek, and Pavel Kouřim are with the Czech University of Life Sciences Prague, 16500 Prague, Czech Republic (e-mail: libra@tf.czu.cz; petrikt@tf.czu.cz; poulek@tf.czu.cz; kourim@tf.czu.cz).

Igor I. Tyukhov is with the Department of Mechanical Engineering, San Jose State University, San Jose, CA 95192 USA (e-mail: ityukhov@yahoo.com).

Digital Object Identifier 10.1109/JPHOTOV.2021.3108484

where the temperature changes by up to 100 °C during the year. Temperatures below -100 °C are not common on the Earth's surface, but may occur in deep space applications [23]. PV energy conversion can be used as far as the orbit of Jupiter. On distant paths, the intensity of the solar radiation would be weak and another energy source must be used (for example, thermoelectric energy conversion—Seebeck thermoelectric cells and radioactive material or fission reactor as a heat source [24], [25]).

Thus, the construction of PV systems requires reliability often in a very wide temperature range, which is not guaranteed for conventional PV modules. The work [26] informed about the new-generation PV modules that were developed for use in locations with extreme climatic conditions, such as Siberia, Arctic, Antarctica, as well as for instance North Africa. In such areas, the PV system must be designed to withstand not only temperature changes but also the aforementioned changes in PV module parameters, in particular changes in electrical voltage.

II. MATERIALS AND METHODS

The to measure these characteristics in the widest possible temperature range. Measuring in such a wide temperature range is very complicated. The work lasted for about a year and we gradually measured everything many times and improved the measuring method and improved the measuring apparatus.

The PV cell based on monocrystalline silicon (Solartec SC2-04, size 2320 mm², thickness 0.27 mm) was used for the measurement. The measurement took place in a vacuum chamber to prevent condensation of air humidity on the cooled PV cell. We used a single-stage rotary oil pump for pumping. The chamber pressure was about 2000 Pa. The halogen incandescent lamp with a reflector was the source of radiation (Osram, voltage 12 V, power 20 W, angle 36°). It illuminated the chamber through a window of clear acrylate glass. The lamp was powered from a stabilized source Agilent E3632A. The spectrum of this radiation is continuous and is similar to that of a black body at about 2900 °C. The radiation intensity on the PV cell was 297 W m⁻², which is less than the intensity of direct sunlight, but there was no significant heating up of the PV cell by the incident radiation. In the case of low-temperature measurements, the PV cell was placed on an aluminum heat exchanger. Thermally conductive pad (Arctic Thermal pad) provided the thermal contact and temperature homogeneity. The liquid nitrogen was the cooling medium. The same configuration was used to measure above room temperature, but a small-plate cooker with autotransformer power control was the heat source. The thermal contact was again provided by the thermally conductive pad.

The actual temperature of the PV cell was determined by the indirect method from the temperature dependence of the I - V characteristic of the unlit PV cell (large area photo diode). During the measurement, the PV cell was cooled relatively quickly. In the system, liquid nitrogen-exchanger-thermally conductive paste-PV cell, there was a large temperature gradient. Measuring the temperature at a location other than exactly in the PV cell would be inaccurate and dependent on the cooling rate (temperature gradient). Therefore, the temperature dependence of the I - V characteristic of the not-illuminated PV cell on the temperature was determined (with very slow cooling, i.e., with a minimum temperature gradient, using a thermocouple just on the upper surface of the PV cell). This dependence was then used to determine the actual temperature of the PV cell in the experiment. The not-illuminated PV cell thus

measured its own temperature, independent of the temperature gradient.

The diode was calibrated as a thermometer with diode voltage values at a constant current of 0.2 A for the entire temperature range. We have chosen this current value because the current is moving around this value at full illumination with the reflector. The temperature for calibration was measured on the cell by a K-type thermocouple probe. The diagram of the apparatus for measurement of I - V characteristics is shown in Fig. 1.

The following four phases were repeated cyclically.

- 1) The PV cell is not illuminated, a constant current of 0.2 A (Agilent source E3631A) flows through it, and the voltage on the PV cell is load. This voltage value is used to determine the PV cell temperature in a given measurement cycle.
- 2) The PV cell is illuminated, the transistor is closed, and open-circuit voltage V_{oc} is measured.
- 3) The PV cell is illuminated, the transistor is opened and closed by a saw tooth signal (Agilent 33220A signal source), and the voltage values V and the current I on the I - V characteristics are measured.
- 4) The PV cell is illuminated, the transistor is fully opened, and current close to short-circuit current I_{sc} is measured. Since a resistor is used to measure current, it is not possible to measure up to a short-circuit current.

The data logger—Agilent 34972A—served for data collection.

During the measurement, the PV cell was cooled relatively quickly. In the system, liquid nitrogen/exchanger/thermally conductive paste/PV cell, there was a temperature gradient. Measuring the temperature at a location other than exactly in the PV cell would be inaccurate and dependent on the cooling rate (temperature gradient). Therefore, the temperature dependence of the I - V characteristic of the not-illuminated PV cell on the temperature was determined (with very slow cooling, i.e., with a minimum temperature gradient, using a thermocouple just on the PV cell). This dependence was then used to determine the actual temperature of the PV cell in the experiment. The not-illuminated PV cell thus measured its own temperature, independent of the temperature gradient.

III. RESULTS

In Fig. 2, the measured I - V characteristics of the PV cell are measured over a very wide temperature range from -170 °C to $+100$ °C. Fig. 3 shows the converted P - V characteristics.

It can be seen that with increasing temperature, the open-circuit voltage decreases and the short-circuit current increases. Also, with increasing temperature, the maximum electrical power supplied by the PV cell at constant radiation intensity is reduced. Thus, the efficiency of energy conversion is also reduced. The relationship between this behavior and the physical theory of semiconductors is discussed below. The influence of this behavior on the design of PV systems is discussed as well.

IV. DISCUSSION

In the available literature, we did not find measurements of temperature dependences of the I - V characteristics of PV cells in such a wide temperature range. For example, in the work [29], similar dependences were measured in the temperature range $+25$ °C to $+80$ °C. We measured similar dependences in the

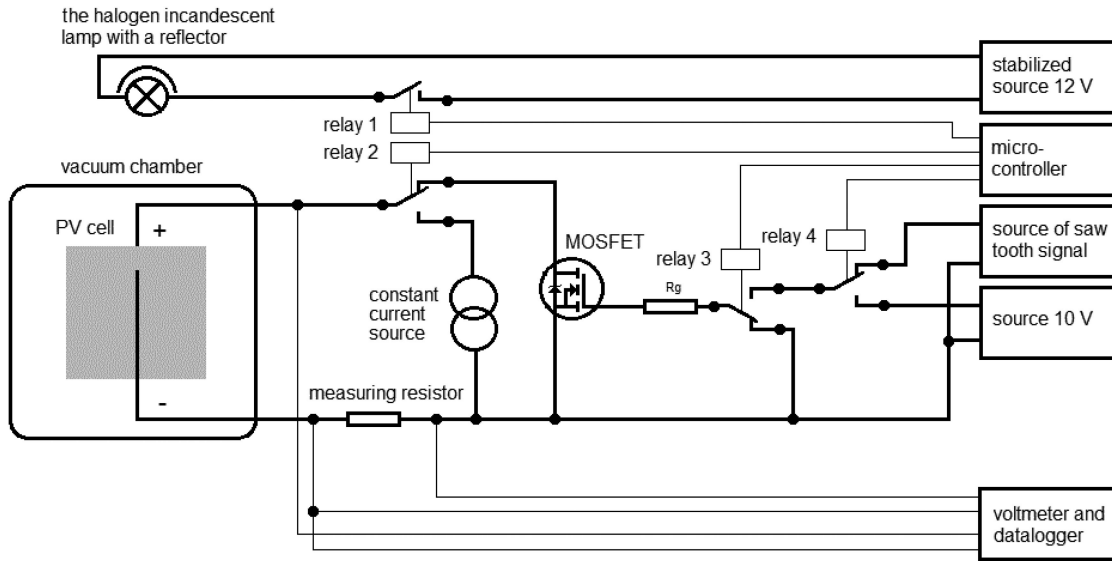

Fig. 1. Scheme of apparatus for measuring I - V characteristics.

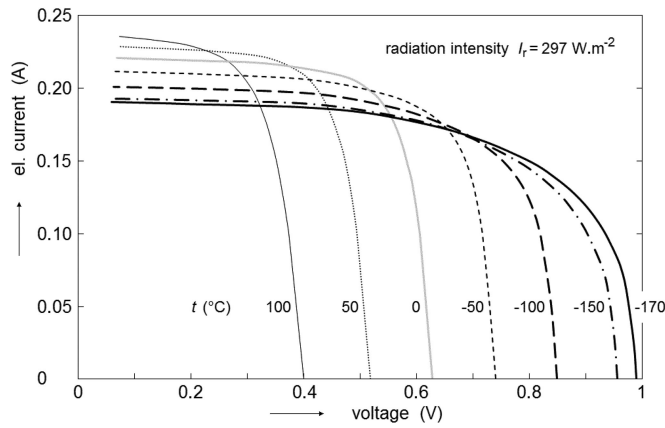

Fig. 2. I - V characteristics of the PV cell measured over a very wide temperature range from -170 °C to $+100$ °C.

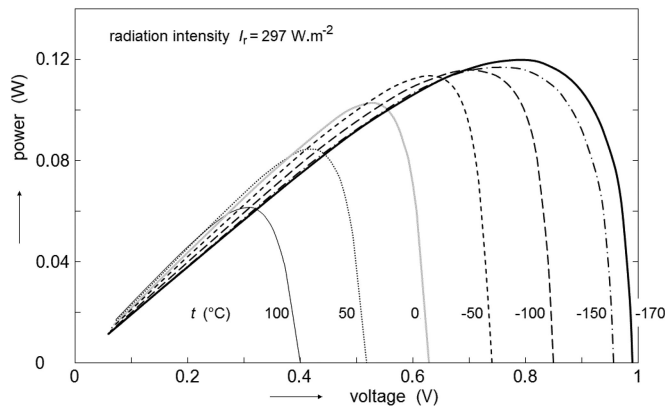

Fig. 3. Recalculated P - V characteristics in a very wide temperature range from -170 °C to $+100$ °C.

temperature range -15 °C to $+35$ °C [27]. Even in other works, we did not find a measurement in the temperature interval below -15 °C.

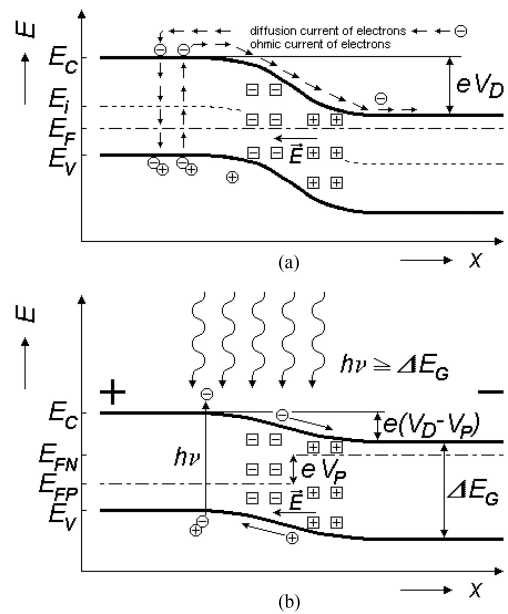

Fig. 4. Scheme of energy levels of PN junction according to well-known physical theory of semiconductors.

Fig. 4 shows a known schematic of the PN junction energy levels according to the physical theory of semiconductors [7], [28]. In the unlit PN junction [Fig. 4(a)], the Fermi energy level is aligned throughout the crystal. This causes bending of the bands and the formation of a diffusion voltage V_D , which is compensated by the electric field at the PN junction. Outwardly, the crystal is electrically neutral, but there is a strong electric field inside. If photons with a higher energy than the forbidden gap impact on the PN junction, electron-hole pairs are generated [Fig. 4(b)]. The electric field of the PN junction separates electrons and holes. The bending of the bands is equalizing and thus the levels of the Fermi energy E_F on the semiconductor side P and N are separated. A PV voltage V_P is generated between the side of the semiconductor P and N, as shown in Fig. 4(b).

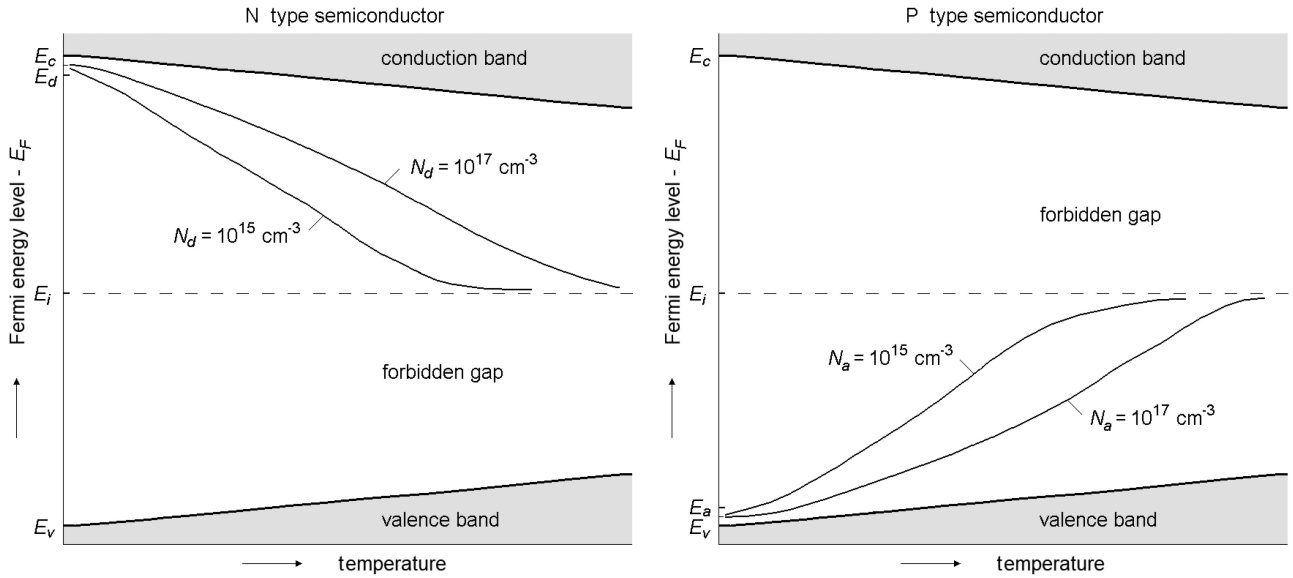

Fig. 5. Changes of forbidden gap width and Fermi energy level versus temperature according to physical theory of semiconductors.

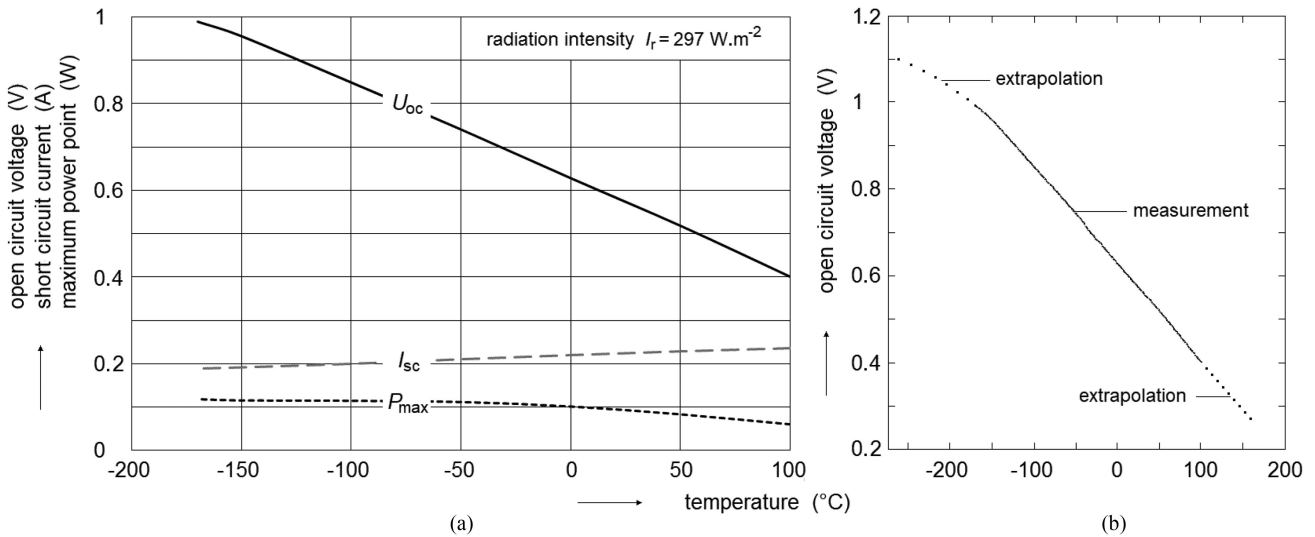

Fig. 6. Temperature dependence of the open-circuit voltage, short-circuit current, and maximum power point of PV cell (a) and extrapolation (b).

In the band model of semiconductor energy levels at very low temperatures, the Fermi energy level is in the forbidden gap. On the N side, it is near the bottom of the conductive band, and, on the P side, it is near the top of the valence band. As the temperature rises, the Fermi energy level moves toward the center of the forbidden gap. At the same time, the width of the forbidden gap decreases. This is shown in Fig. 5. According to [34], the dependence is given by the (1):

$$E_g(T) = E_g(0) - \frac{\alpha T^2}{T + \beta} \tag{1}$$

For monocrystalline silicon, $E_g(0) = 1.16$ eV is the width of the band gap at the temperature 0 K, $\alpha = 7.02 \times 10^{-4}$ eV K⁻¹, $\beta = 1108$ K. Reducing the width of the band gap means that even photons with lower energy can cause the PV energy conversion.

This reduces the open-circuit PV voltage and increases the short-circuit current. Thus, the behavior of the I - V characteristics in Fig. 2 above is consistent with this theory.

Fig. 6 shows the temperature dependences of the open-circuit voltage, short-circuit current, maximum power point, and extrapolation. It can be seen that this dependence U_{oc} is almost linear over a wide range of temperatures. But extrapolating this dependence to -273 °C would give an open-circuit voltage of about 1.28 V. The width of the forbidden gap for silicon is approximately 1.1 eV. When the bending of the bands is fully aligned, the difference in Fermi energy levels cannot be greater than 1.1 eV. Thus, the open-circuit PV voltage cannot be greater than 1.1 V. It can be seen in Fig. 6 that the curve deviates from the linear dependence around -150 °C and its derivative is changed to not exceed 1.1 eV at lower temperatures. By comparing the curves in Figs. 5 and 6, it can be seen that the approximately linear parts of these curves correspond roughly,

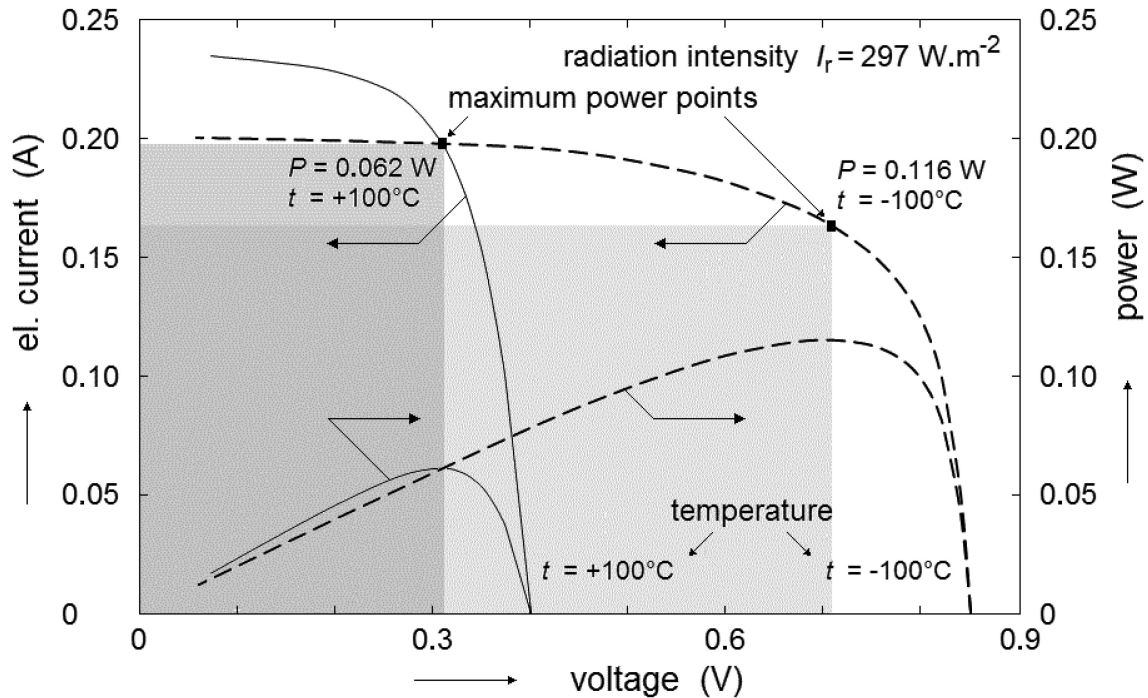

Fig. 7. Maximum power points on I - V characteristics at different temperatures -100 °C, $+100$ °C.

and the derivative of the curve changes at both ends. The extrapolation of the linear part of the curve in Fig. 6 to zero PV voltage would give a temperature value of about 260 °C. Probably there will also be a deviation from the linear dependence, and the energy conversion efficiency will be very small at temperatures above 200 °C. This fact is important for PV systems with higher radiation concentration.

Since a resistor is used to measure current and due to resistance of contacts and wires, it is not possible to measure up to a short-circuit current. The resistances are connected in series with the PV cell. But it can be seen in Fig. 2 that the PV characteristics were measured almost to the short-circuit current and the temperature dependence of the short-circuit current is evident. The I_{sc} values in Fig. 6 are extrapolated.

Fig. 7 shows a comparison of the maximum power of the PV cell at temperatures of $+100$ °C and -100 °C. Roughly at this interval, the temperatures of the PV systems can move without the concentration of radiation on the Earth's surface. The PV systems used in space can have an even wider temperature range. The maximum power is achieved by the PV cell when the rectangle given by the axes and the working point on the I - V characteristic have the largest area (see Fig. 7). It can be seen that at a given intensity of radiation at a temperature of $+100$ °C, the maximum power is 0.062 W, and at a temperature of -100 °C, the maximum power is 0.116 W. This is roughly double. Thus, a temperature difference of 200 °C corresponds to a change in energy conversion efficiency of about 100% . This means that in the temperature range that a PV system can have on the Earth's surface, the change in energy conversion efficiency is about $0.5\%/^{\circ}\text{C}$.

This effect of temperature on the efficiency of PV energy conversion means that extreme values of solar radiation do not necessarily mean extreme yield of the PV power plant [17]. It would seem logical that if the sun is shining, the yield of the

PV power plant is high and vice versa. Tropical areas have a high intensity of sunlight (especially in Africa, Australia, and Central America). The yield of PV power plants is good but not excellent. The highest yields are usually found in the much more northern and colder areas of Tibet and Mongolia with higher altitudes. The plateaus of Chile in the Atacama Desert are also an excellent location. Also, on the coast of Antarctica, similar annual yields can be achieved as in subtropical areas, but here it is appropriate to use the mentioned new-generation PV modules for extreme climatic conditions [26].

The best regions for the operation of PV power plants are therefore inland areas with higher altitude, high intensity of solar radiation, and low temperature. In addition, in the case of grid-free regions (Tibet, Mongolia), the importance of small off-grid PV systems increases.

V. CONCLUSION

In our laboratory, we conducted measurements of I - V characteristics of PV cell based on monocrystalline silicon in a very wide range of temperatures from -170 °C to $+100$ °C (see Fig. 2). So far, we have not found any measurements in such a wide range of temperatures in the literature. On the Earth's surface, the temperature of the PV system without radiation concentration can reach about -100 °C to $+100$ °C. But in the case of using a PV system in deep space, temperatures may be much lower in the whole range of values measured. Especially, spacecraft designers need to be careful, because higher voltage can damage devices. The behavior of the temperature dependence of I - V characteristics and P - V characteristics was discussed above in terms of the physical theory of semiconductors (see Figs. 4 and 5). The open-circuit voltage dependence is approximately linear over the entire temperature range that the PV system can achieve on the Earth's surface (see

Fig. 6). However, at temperatures around $-150\text{ }^{\circ}\text{C}$, saturation occurs, which was also explained in accordance with the physical theory of semiconductors. The decrease in energy conversion efficiency with increasing temperature has a constant value of approximately $0.5\%/^{\circ}\text{C}$ over the entire temperature range from $-100\text{ }^{\circ}\text{C}$ to $+100\text{ }^{\circ}\text{C}$ (see Figs. 3 and 7).

If the PV system operates in locations with extreme climatic conditions, especially with extreme temperature changes during the year, the electrical voltage of the PV modules will change significantly (up to about 60%; see Fig. 6). In the case of space applications, these fluctuations may be even more significant, and especially for these applications, our measurement is very significant. The use of radiation concentrators can also significantly increase the operating temperature range. This must be taken into account in the design of the PV system, and the individual components must be carefully selected. Especially, electronic inverters tend to be sensitive to overvoltage or undervoltage [30], [31]. The operating temperature of PV modules can be also reduced by designing a water-cooled PV/PT system [32]. PV modules can also affect the temperature of their surroundings [33].

REFERENCES

- [1] S. Kurtz *et al.*, "Historical analysis of champion photovoltaic module efficiencies," *IEEE J. Photovolt.*, vol. 8, no. 2, pp. 363–382, Mar. 2018, doi: [10.1109/JPHOTOV.2018.2794387](https://doi.org/10.1109/JPHOTOV.2018.2794387).
- [2] M. A. Green, "General temperature dependence of solar cell performance and implications for device modelling," *Prog. Photovolt. Res. Appl.*, vol. 11, pp. 333–340, 2003, doi: [10.1002/ppa.496](https://doi.org/10.1002/ppa.496).
- [3] O. Dupré, R. Vaillon, and M. A. Green, "Physics of the temperature coefficients of solar cells," *Sol. Energy Mater. Sol. Cells*, vol. 140, pp. 92–100, 2015, doi: [10.1016/j.solmat.2015.03.025](https://doi.org/10.1016/j.solmat.2015.03.025).
- [4] C. Kittel, *Introduction to Solid State Physics*. Danvers, MA, USA: Wiley, 2005.
- [5] G. E. Pikus, *Basic Theory of Semiconductor Devices*. Moscow, Russia: Mayka, 1965.
- [6] D. S. Strebkov, *Matrix Solar Cells*. Moscow, Russia: ВИАЭС, 2010, pp. 119–181.
- [7] V. Poulek and M. Libra, *Photovoltaics*. Prague, Czech Republic: ILSA, 2010, pp. 43–53.
- [8] J. Siecker, K. Kusakana, and B. P. Numbi, "A review of solar photovoltaic systems cooling technologies," *Renewable Sustain. Energy Rev.*, vol. 79, pp. 192–203, 2017, doi: [10.1016/j.rser.2017.05.053](https://doi.org/10.1016/j.rser.2017.05.053).
- [9] W. T. da Costa, J. F. F. Fardin, L. V. B. M. Neto, and D. S. L. Simonetti, "Estimation of irradiance and temperature using photovoltaic modules," *Sol. Energy*, vol. 110, pp. 132–138, 2014, doi: [10.1016/j.solener.2014.08.040](https://doi.org/10.1016/j.solener.2014.08.040).
- [10] J. Li, R. Li, Y. Jia, and Z. Zhang, "Prediction of I–V characteristic curve for photovoltaic modules based on convolutional neural network," *Sensors*, vol. 20, 2020, Art. no. 2119, doi: [10.3390/s20072119](https://doi.org/10.3390/s20072119).
- [11] H. Baig, L. Sellami, and T. K. Mallick, "Performance modeling and testing of a building integrated concentrating photovoltaic (BICPV) system," *Sol. Energy Mater. Sol. Cells*, vol. 134, pp. 29–44, 2015, doi: [10.1016/j.solmat.2014.11.019](https://doi.org/10.1016/j.solmat.2014.11.019).
- [12] D. Chemisana, M. Ibanez, and J. I. Rosell, "Characterization of a photovoltaic-thermal module for Fresnel linear concentrator," *Energy Convers. Manage.*, vol. 52, pp. 3234–3240, 2011, doi: [10.1016/j.enconman.2011.04.008](https://doi.org/10.1016/j.enconman.2011.04.008).
- [13] T. Matuška, B. Šourek, V. Jirka, and N. Pokorný, "Glazed PVT collector with polysiloxane encapsulation of PV cells: Performance and economic analysis," *Int. J. Photoenergy*, vol. 2015, 2015, Art. no. 718316, doi: [10.1155/2015/718316](https://doi.org/10.1155/2015/718316).
- [14] F. Grubišić-Čabo, S. Nižetić, I. M. Kragić, and D. Čoko, "Further progress in the research of fin-based passive cooling technique for the free-standing silicon photovoltaic panels," *Int. J. Energy Res.*, vol. 43, pp. 3475–3495, 2019, doi: [10.1002/er.4489](https://doi.org/10.1002/er.4489).
- [15] V. Shemelin and T. Matuška, "Detailed modeling of flat plate solar collector with vacuum glazing," *Int. J. Photoenergy*, 2017, Art. no. 1587592, doi: [10.1155/2017/1587592](https://doi.org/10.1155/2017/1587592).
- [16] C. Correa-Betanzo, H. Calleja, and S. De León-Aldaco, "Module temperature models assessment of photovoltaic seasonal energy yield," *Sustain. Energy Technol. Assessments*, vol. 27, pp. 9–16, 2018, doi: [10.1016/j.seta.2018.03.005](https://doi.org/10.1016/j.seta.2018.03.005).
- [17] V. Poulek, T. Matuška, M. Libra, E. Kachalouski, and J. Sedláček, "Influence of increased temperature on energy production of roof integrated PV panels," *Energy Buildings*, vol. 166, pp. 418–425, 2018, doi: [10.1016/j.enbuild.2018.01.063](https://doi.org/10.1016/j.enbuild.2018.01.063).
- [18] O. Dupré, R. Vaillon, and M. A. Green, "A full thermal model for photovoltaic devices," *Sol. Energy*, vol. 140, pp. 73–82, 2016, doi: [10.1016/j.solener.2016.10.033](https://doi.org/10.1016/j.solener.2016.10.033).
- [19] C. Coskun, U. Toygar, O. Sarpdag, and Z. Oktay, "Sensitivity analysis of implicit correlations for photovoltaic module temperature: A review," *J. Cleaner Prod.*, vol. 164, pp. 1474–1485, 2017, doi: [10.1016/j.jclepro.2017.07.080](https://doi.org/10.1016/j.jclepro.2017.07.080).
- [20] V. Poulek, M. Q. Dang, M. Libra, V. Beránek, and J. Šafránková, "PV panel with integrated lithium accumulators for BAPV applications—one year thermal evaluation," *IEEE J. Photovolt.*, vol. 10, no. 1, pp. 150–152, Jan. 2020, doi: [10.1109/JPHOTOV.2019.2953391](https://doi.org/10.1109/JPHOTOV.2019.2953391).
- [21] M. Lee, J. Park, S. I. Na, H. S. Choi, B. S. Bu, and J. Kim, "An analysis of battery degradation in the integrated energy storage system with solar photovoltaic generation," *Electronics*, vol. 9, 2020, Art. no. 701, doi: [10.3390/electronics9040701](https://doi.org/10.3390/electronics9040701).
- [22] M. Dhimish and A. Alrashidi, "Photovoltaic degradation rate affected by different weather conditions: A case study based on PV systems in the U.K. and Australia," *Electronics*, vol. 9, 2020, Art. no. 650, doi: [10.3390/electronics9040650](https://doi.org/10.3390/electronics9040650).
- [23] S. Park, J. C. Bourgoin, O. Cavani, V. Khorenko, C. Baur, and B. Boizot, "Origin of the degradation of triple junction solar cells at low temperature," in *Proc. 11th Eur. Space Power Conf., E3S Web Conf.*, 2017, Art. no. 04004, doi: [10.1051/e3sconf/20171604004](https://doi.org/10.1051/e3sconf/20171604004).
- [24] K. Liu *et al.*, "Experimental prototype and simulation optimization of micro-radial milliwatt-power radioisotope thermoelectric generator," *Appl. Thermal Eng.*, vol. 125, pp. 425–431, 2017, doi: [10.1016/j.applthermaleng.2017.07.022](https://doi.org/10.1016/j.applthermaleng.2017.07.022).
- [25] W. Zhang, D. Zhang, X. Liu, W. Tian, S. Qiu, and G. H. Su, "Thermal-hydraulic analysis of the thermoelectric space reactor power system with a potassium heat pipe radiator," *Ann. Nucl. Energy*, vol. 136, 2020, Art. no. 107018, doi: [10.1016/j.anucene.2019.107018](https://doi.org/10.1016/j.anucene.2019.107018).
- [26] V. Poulek, D. S. Strebkov, I. S. Persic, and M. Libra, "Towards 50 years lifetime of PV solar modules laminated with silicone gel technology," *Sol. Energy*, vol. 86, pp. 3103–3108, 2012, doi: [10.1016/j.solener.2012.07.013](https://doi.org/10.1016/j.solener.2012.07.013).
- [27] M. Libra, V. Poulek, and P. Kouřím, "Temperature changes of I–V characteristics of photovoltaic cells as a consequence of the Fermi energy level shift," *Res. Agricultural Eng.*, vol. 63, no. 1, pp. 10–15, 2017, doi: [10.17221/38/2015-RAE](https://doi.org/10.17221/38/2015-RAE).
- [28] Y. D. Arbutov and V. M. Evdokimov, *Fundamentals of Photovoltaics*. Moscow, Russia: GNU VIESH, 2008, pp. 70–137.
- [29] F. Khan, S. H. Baek, and J. H. Kim, "Wide range temperature dependence of analytical photovoltaic cell parameters for silicon solar cells under high illumination conditions," *Appl. Energy*, vol. 183, pp. 715–724, 2016, doi: [10.1016/j.apenergy.2016.09.020](https://doi.org/10.1016/j.apenergy.2016.09.020).
- [30] H. Jeong, H. Lee, Y. Ch. Liu, and K. A. Kim, "Review of differential power processing converter techniques for photovoltaic applications," *IEEE Trans. Energy Convers.*, vol. 34, no. 1, pp. 351–360, Mar. 2019, doi: [10.1109/TEC.2018.2876176](https://doi.org/10.1109/TEC.2018.2876176).
- [31] A. E. Lazzaretti *et al.*, "A monitoring system for online fault detection and classification in photovoltaic plants," *Sensors*, vol. 20, 2020, Art. no. 4688, doi: [10.3390/s20174688](https://doi.org/10.3390/s20174688).
- [32] T. Zhang, Z. W. Yan, L. Xiao, H. D. Fu, G. Pei, and J. Ji, "Experimental study and design sensitivity analysis of a heat pipe photovoltaic/thermal system," *Appl. Thermal Eng.*, vol. 162, 2019, Art. no. 114318, doi: [10.1016/j.applthermaleng.2019.114318](https://doi.org/10.1016/j.applthermaleng.2019.114318).
- [33] M. Bilčík, M. Božiková, and J. Čímo, "Influence of roof installation of PV modules on the microclimate conditions of cattle breeding objects," *Appl. Sci.*, vol. 11, 2021, Art. no. 2140, doi: [10.3390/app11052140](https://doi.org/10.3390/app11052140).
- [34] Y. P. Varshni, "Temperature dependence of the energy gap in semiconductors," *Physica*, vol. 34, no. 1, pp. 149–154, 1967, doi: [10.1016/0031-8914\(67\)90062-6](https://doi.org/10.1016/0031-8914(67)90062-6).
- [35] M. Zaimi, H. El Achouby, O. Zegoudi, A. Ibrail, and E. M. As-said, "Numerical method and new analytical models for determining temporal changes of model-parameters to predict maximum power and efficiency of PV module operating outdoor under arbitrary conditions," *Energy Convers. Manage.*, vol. 220, 2020, Art. no. 113071, doi: [10.1016/j.enconman.2020.113071](https://doi.org/10.1016/j.enconman.2020.113071).