

# Distributed Power-Generation Systems and Protection

*This paper investigates the role of distributed power generation in power grid resilience improvement and the associated protection issues.*

By FREDE BLAABJERG, *Fellow IEEE*, YONGHENG YANG, *Member IEEE*, DONGSHENG YANG, *Member IEEE*, AND XIONGFEI WANG, *Member IEEE*

**ABSTRACT** | Continuously expanding deployments of distributed power-generation systems (DPGSs) are transforming the conventional centralized power grid into a mixed distributed electrical network. The modern power grid requires flexible energy utilization but presents challenges in the case of a high penetration degree of renewable energy, among which wind and solar photovoltaics are typical sources. The integration level of the DPGS into the grid plays a critical role in developing sustainable and resilient power systems, especially with highly intermittent renewable energy resources. To address the challenging issues and, more importantly, to leverage the energy generation, stringent demands from both utility operators and consumers have been imposed on the DPGS. Furthermore, as the core of energy conversion, numerous power electronic converters employing advanced control techniques have been developed for the DPGS to consolidate the integration. In light of the above, this paper reviews the power-conversion and control technologies used for DPGSs. The impacts of the DPGS on the distributed grid are also examined, and more importantly, strategies for enhancing the connection and protection of the DPGS are discussed.

**KEYWORDS** | Control; distributed power-generation systems (DPGSs); grid codes; grid resilience; photovoltaic (PV) power systems; power conversion; power electronics; power grid protection; wind power generation

## I. INTRODUCTION

In the past decades, because of the foreseen exhaustion of conventional fossil-based energies (e.g., coal, oil, and natural

gas), considerable worldwide attention has been paid to making societies sustainable. Additionally, the exploitation and utilization of conventional fossil energy resources pollute the natural environment and appear to affect the temperature on Earth. Thus, traditional centralized power generation using fossil fuels is considered unsustainable in national long-term strategic plans. Consequently, many efforts globally have been directed toward developing more renewable energy sources, such as wind and solar photovoltaics (PVs), solar thermal power, hydropower, bioenergy, and ocean power [1]–[4]. Typically, renewable energy sources are integrated in the form of distributed power-generation systems (DPGS), as shown in Fig. 1. The power generation in Denmark has changed from centralized to decentralized with the widespread use of windfarms [5]. Fig. 2 depicts the evolution of worldwide renewable energy capacity from 2000 to 2015, where hydropower ranks first with regard to total installed capacity, followed by wind and solar PV power. However, the most favorable sources are wind and solar PV power, as evidenced by the growth rates for 2010–2015 shown in Fig. 3 [4].

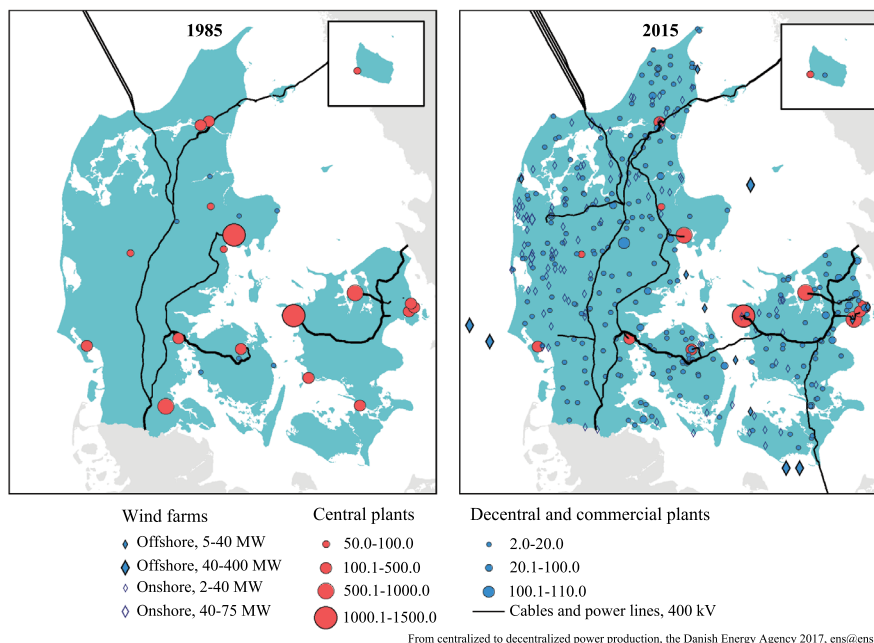
The special requirements of hydropower (e.g., physical locations for river or lake resources) have slowed its utilization and development. In contrast, wind and solar PV power is easier to access, with less physical location dependency. Hence, it has become dominant in DPGSs, as demonstrated in Fig. 1. Furthermore, it has less impact on the environment and a larger untapped capacity. As shown in Fig. 3, among the major renewable energy technologies, the worldwide wind and PV power generation achieved the fastest growth rates of 17% and 28%, respectively, in 2015 [4]. As a specific example, in 2015, the wind power share of the total net generation in Denmark was >50% [6]. Many other countries are catching up with a high growth rate [7]–[9]. Thus, these two renewables (wind and PV energy) will continue to be the major resources of DPGSs [9]. Consequently, wind and PV-based DPGS are the focus of this study.

Manuscript received March 9, 2017; revised March 22, 2017; accepted April 10, 2017. Date of publication May 11, 2017; date of current version June 16, 2017. This work was supported in part by the European Research Council (ERC) under the European Union's Seventh Framework Program (FP/20072013)/ERC Grant Agreement 321149-Harmony; and also by VILLUM FONDEN under the VILLUM Investigator's Grant—REPEPS. (Corresponding author: Frede Blaabjerg.)

The authors are with the Department of Energy Technology, Aalborg University, Aalborg, DK-9220 Denmark (e-mail: fbl@et.aau.dk; yoy@et.aau.dk; doy@et.aau.dk; xwa@et.aau.dk).

Digital Object Identifier: 10.1109/JPROC.2017.2696878

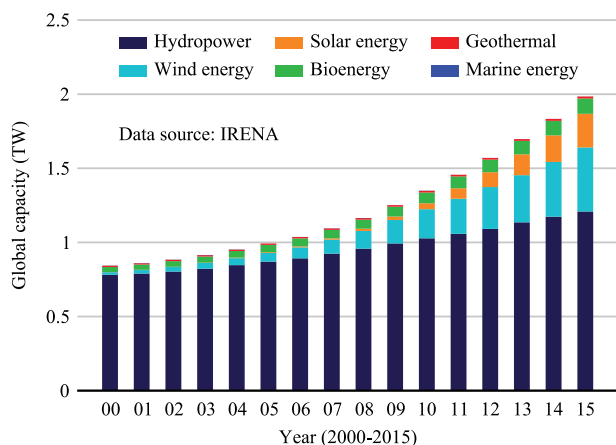
0018-9219 © 2017 IEEE. Translations and content mining are permitted for academic research only. Personal use is also permitted, but republication/redistribution requires IEEE permission. See [http://www.ieee.org/publications\\_standards/publications/rights/index.html](http://www.ieee.org/publications_standards/publications/rights/index.html) for more information.



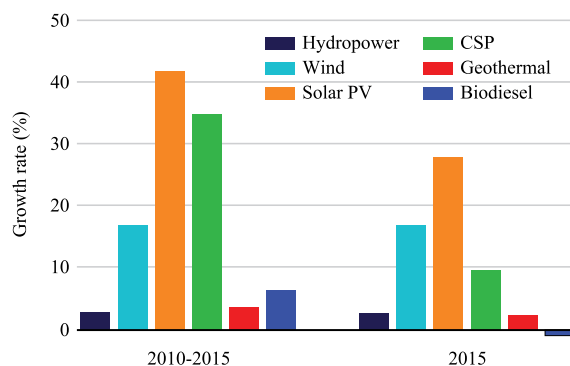
**Fig. 1. Decentralized power generation in Denmark (left: centralized electric power infrastructure in 1985, right: decentralized electric power infrastructure in 2015) [5]. As shown, more than 50% of the energy is covered by renewables.**

Beyond clean energy generation for more sustainable societies, the integration of massive DPGSs poses many challenging issues to the distribution power grid and to the utility [10]–[14]. For instance, owing to the energy resource intermittency, the power injected into the distribution networks by the DPGS is always time-varying and fluctuating, which may affect the network stability, especially at a high penetration degree of renewables under the current mixed energy infrastructure (i.e., conventional and decentralized generation systems) [8]. Additionally, for operation in harsh environments (e.g., offshore wind DPGS), the DPGS should be

capable of withstanding abnormal interruptions. With these considerations, the transmission system operators (TSOs) and/or distributed system operators (DSOs), together with other stakeholders, have issued stringent interconnection codes to guide the commissioning and operation of DPGSs [15]–[17]. The relevant standards have helped to harmonize the way in which the TSOs/DSOs and other businesses have worked to increase the penetration of DPGSs for a more eco-friendly society. In this case, these guidelines have been the main design and planning benchmarks for DPGSs. On one hand, as the power electronics technology is the key to connecting distributed energy resources [18], the development of the DPGS is driven by the fast advancement of power converter technologies. On the other hand, the aforementioned



**Fig. 2. Global accumulative capacity of renewable energy from 2000–2015 based on the data available from IRENA [1], where hydropower also includes pumped storage and mixed plants; marine energy covers tide, wave, and ocean energy.**



**Fig. 3. Global growth rate of installed capacity for renewable technologies from the end of 2010 to 2015 and in 2015 based on the data from REN21 [4], where CSP represents the concentrated solar power.**

challenges limit the focuses of DPGS research and development to the reliability, affordability, scalability, flexibility, stability, and efficiency of the technology [19], [20].

However, as previously mentioned, the modern DPGS is mixed with highly penetrated renewable energy sources and is vulnerable to severe weather/climate conditions. Therefore, concerns regarding the resiliency have been raised, and the responses of the DPGS to extreme weather conditions should be addressed [19]–[23]; otherwise, power outages might occur. For instance, an estimated 679 widespread power outages occurred in the United States between 2003 and 2012 [21], where the power interruption incidents were caused by extreme climate conditions. Accordingly, highly resilient DPGSs are required. In contrast to system reliability, the resilience mainly involves the ability of the DPGS to

- 1) anticipate potential events;
- 2) rapidly recover from the observed events;
- 3) adapt to prevent future events.

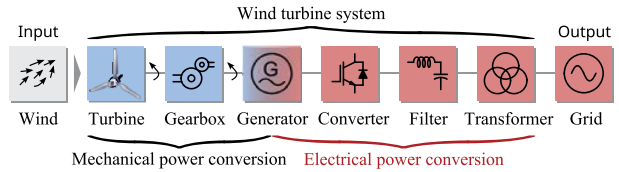
Obviously, to minimize the impacts of disruptive events, potential interruptions should be identified as early as possible by monitoring the entire system in real time. When a sudden incident is recognized, the DPGS should rapidly react to the disturbances via operational and structural changes (e.g., control). The time of response and recovery and the level of recovery are the main indicators for assessing the resilience of DPGS. In the post-event period, the DPGS must learn from these disruptions and adapt in order to prevent similar future events. The aforementioned functions can be achieved through advanced monitoring and intelligent control systems (at the power converter level and the entire system level). In literature, researchers have demonstrated schemes for enhancing the system resilience [24]–[32]. This confirms that the DPGS can offer great flexibility and numerous possibilities for enhancing the entire power grid and consolidate its resilience.

Herein, in light of the above, DPGS technologies are first reviewed, mainly with regard to wind turbine power systems and PV power systems, for which the necessity of a resilient DPGS is presented. Then, resilience-related control schemes are selectively discussed, and the main grid requirements are introduced. The protection issues for a DPGS integrated into a power grid are explored in Section IV. Future challenges, particularly concerning the resilience of the distributed power grid, are presented in Section V, along with concluding remarks.

## II. CONFIGURATIONS OF TYPICAL DPGS

### A. Wind-Power-Generation Technology (Wind DPGS)

A typical configuration of a wind power system connected to distributed grids (Wind DPGS) is shown in Fig. 4. As shown, the input of such a DPGS is wind, which is converted into mechanical energy by the turbine. Then, the turbine drives an electrical machine (generator) that is controlled by power electronic converters. An electrical power conversion stage ensures that the output currents are in phase with the

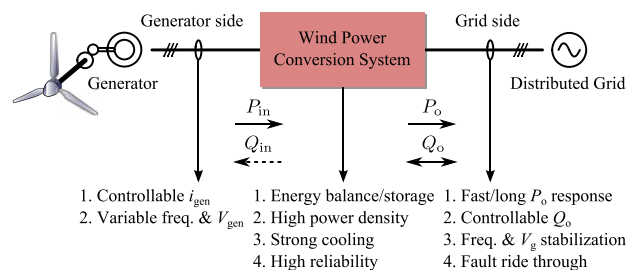


**Fig. 4. Wind-turbine power system-based DPGS (in some cases, the gearbox is removed).**

grid voltages. In general, to maximize the energy harvested, a maximum power pointing tracking (MPPT) scheme should be employed to control the wind turbine speed and/or the pitch angle. Clearly, the captured power fluctuates as the input wind speed changes. Depending on the impedance of the distributed grid, the power fluctuation can affect the stability of the entire system, e.g., influence the voltage variations.

As shown in Fig. 4, a gearbox is typically adopted in the Wind DPGS. For multimegawatt (multi-MW) wind turbines, the rotational speed of the turbine rotor is low. Hence, bulky generators are needed to capture the wind energy, which may incur a high installation cost. As a consequence of using a gearbox, the mechanical power can be converted with a higher speed and lower torque, reducing the size and weight of the electrical generator [33]. Currently, the use of power electronic converters is inevitable. They provide controllability of the electrical power and allow the implementation of advanced functions (e.g., enhancing the resilience). Finally, a transformer is used to boost up the voltage level so that a more efficient power transmission in the distributed grid is achieved.

1) *Requirements for Wind DPGS:* The power electronic converter is the core of the Wind DPGS. Its role is becoming increasingly critical with the fast growth of the capacity of individual wind turbines (now close to 10 MW). Many advanced functions can be realized through the control of the power electronic converter. This indicates that far more stringent requirements should be considered than ever before. Fig. 5 summarizes the demands of wind power systems at different levels.

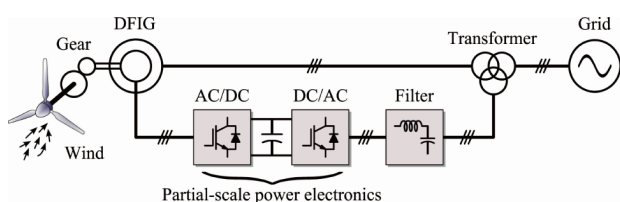


**Fig. 5. Demands for the wind-turbine power-system-based DPGS, where  $P_{in}$  and  $Q_{in}$  are the active and reactive power exchanges between the generator and the power electronic converter, respectively, and  $P_o$  and  $Q_o$  are the active and reactive power exchanges between the power converter and the grid, respectively.**

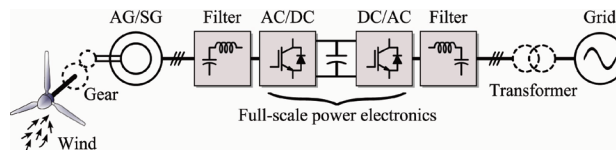
The current ( $i_{gen}$ ) flowing in the generator rotor or stator should be regulated in order to control the electromagnetic torque. This has two major purposes: 1) maximizing the power extracted from the wind turbine; and 2) balancing the energy flow in the case of dynamics because of the inertia mismatch between the mechanical and electrical power conversions. For the grid side, the power converter should be able to emulate the behaviors of conventional power plants regardless of the wind speeds. That is, the power electronic converter should maintain the frequency (Freq.) as well as the voltage amplitude of the distributed grid ( $V_g$ ). More importantly, under severe conditions, the Wind DPGS should withstand grid faults or even contribute to the grid voltage recovery [33]–[38]. This requirement in response to distribution grid faults indirectly reflects the need for high resilience for the Wind DPGS. Upon demand, the wind power system should also be able to exchange reactive power with the distributed grid.

Because of the relatively large power capacity of an individual wind turbine, failures of wind power conversion systems can occur in operation. Downtime of the entire DPGS challenges the grid stability and incurs additional maintenance costs. As a result, the reliability of the power electronic converters is important in the modern Wind DPGS. Design for reliability has been introduced to such systems [39], [40]. Additionally, at the same power level, the voltage level of the wind generators may need to be increased to facilitate the power transmission; thus, step-up transformers are normally connected to the medium voltage, as previously mentioned. Furthermore, the space of the nacelle and/or tower of wind turbines is limited, necessitating a high power density and strong cooling for power converters. Finally, the energy balancing is an important issue in the control and may result in extra costs for the entire DPGS.

2) *Wind DPGS Concepts*: Wind power system designs include several constraints, such as the generator types, the rating and topology of the power converters, and the speed controllability [8], [33], [34]. As previously discussed, the power electronic unit plays an important role in the Wind DPGS. Depending on the generator rating, the power electronic converters vary significantly. Therefore, the configuration of the power conversion stage depends on the generator type. The doubly fed induction generator (DFIG) has dominated the market in the past decades. Fig. 6 shows a wind DPGS employing a DFIG, where the stator windings of



**Fig. 6. Wind-turbine DPGS based on the DFIG technology with partial-scale power electronics.**



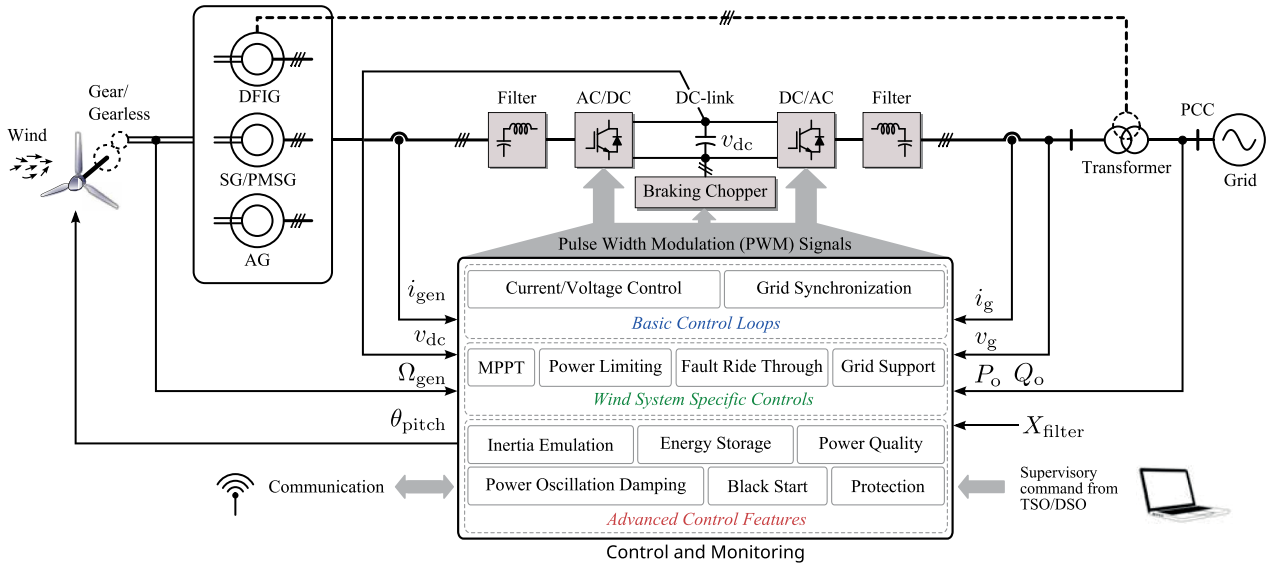
**Fig. 7. Wind-turbine DPGS based on the variable-speed generator technologies (AGs and SGs) with full-scale power electronics.**

the DFIG are directly connected to the power grid. In contrast, the power electronic converters are the link between the rotor windings and the distribution grid. Normally, the power processed by the converters accounts for 30% of the capacity of the wind turbine [41]–[43]. The small capacity of the power converters makes this DFIG concept attractive from the viewpoint of cost saving. However, the DFIG system uses slip rings, and in the case of grid faults, the power controllability is difficult to maintain [44]–[46]. That is, the DFIG system adopts partial-scale power electronics, and the controllability is limited under abnormal operation.

To increase the controllability and power processing flexibility, asynchronous generators (AGs) and synchronous generators (SGs) with full-scale power electronics have gained an increasing market share, dominating the current wind power market [8]. A Wind DPGS with AG or SG is represented in Fig. 7, which shows that the full-scale power electronics are the direct link between the distributed grid and the stator windings of the generators. Hence, the power generated by the wind turbine can be flexibly regulated. The generator can be a squirrel-cage induction generator (IG), a direct current (dc)-excited SG (DCSG), or a permanent-magnet SG (PMSG). The elimination of slip rings, a simpler or even eliminated gearbox, full power and speed controllability, and better grid support ability are the main advantages of this wind power concept in contrast to the DFIG-based wind systems. The main drawbacks include the more stressed and expensive power electronic components and higher power losses in the power electronic converter stage compared with the previous concept.

3) *General Control of Wind DPGS*: Controlling a wind-turbine DPGS involves both fast and slow dynamic controllers, as indicated in Fig. 5, because both the mechanical and electrical conversion subsystems should be controlled. The control functions can be categorized into three levels, as shown in Fig. 8. In general, the power flowing in and out of the generation system must be properly managed. The power generated by the wind turbines should be controlled using the mechanical systems (e.g., to adjust the pitch angle of blades, yawing system, etc.). When the DSO has sent out certain demands, the entire DPGS must satisfy these demands through the control of the mechanical and electrical systems. In addition, the currents injected into the distributed grid should be synchronized with the grid voltage.

As the input wind speed is not constant, the available power also varies. Hence, more advanced functions should be considered, such as the maximization of the generated



**Fig. 8. General control structure for modern wind DPGS** ( $i_{gen}$ : generator current,  $v_{dc}$ : dc-link voltage,  $\Omega_{gen}$ : rotational speed of generator,  $\theta_{pitch}$ : pitch angle of rotor blade,  $i_g$ : grid current,  $v_g$ : grid voltage,  $X_{filter}$ : filter impedance, PCC: point of common coupling).

power (MPPT) and the ride-through operation of the grid faults and grid support (injecting or absorbing reactive power). For instance, the currents in the generators can be controlled by adjusting the rotational speed of the wind turbine to maximize the power production. In some cases, excessive power injection may drive the distributed grid voltage level beyond the boundaries; thus, the wind-turbine DPGS should be able to limit the active power injection. Additionally, for operation under grid faults, the coordinated control of several subsystems in the wind turbine, such as the generator/grid side converters, braking chopper/crowbar, and pitch angle controller is necessary.

Notably, various control functions can be achieved through the control and adjustment of the entire wind DPGS system. Thus, the resilience enhancement is also possible in the control DPGS. The basic control functions, such as current regulation, dc-link stabilization, and grid synchronization must be rapidly performed to ensure stable and safe operation.

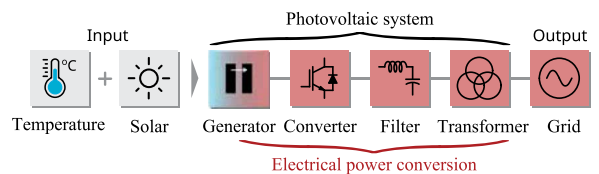
**B. PV Power-Generation Technology (PV DPGS)**

The fast development of PV cell technologies, the continuous cost reduction of PV modules, and advancements in power electronics have been the main driving forces for the intensive deployment of PV DPGSs [47]–[50]. It is expected that the cost of PV technology will continue declining, which will make PV systems competitive among other renewable energy systems. Hence, more PV DPGS will be seen in the future.

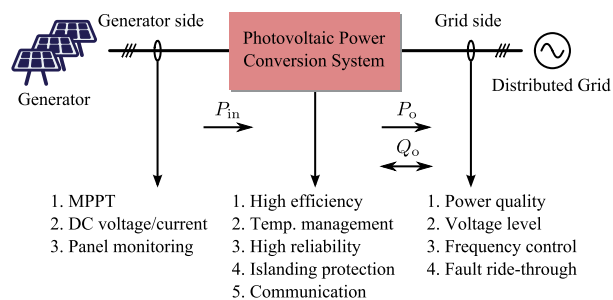
In contrast to the Wind DPGS, the DPGS with PVs as the input does not involve mechanical conversion, as shown in Fig. 9. Instead, the power generation is achieved by exploiting the photovoltaic effect that converts solar energy to electrical energy. Because the mechanical parts of the wind

turbine wear out, the PV DPGS is more reliable than the Wind DPGS. Nonetheless, both these DPGS technologies share the same electrical conversion stages. That is, the power electronics are the key to the efficient and reliable conversion of the solar energy, which is highly dependent on the environmental conditions (e.g., solar irradiance level and ambient temperature). Thus, in a similar way, many advanced functions of the PV DPGS can be achieved through the control of the power electronic converters. For instance, the maximum power extraction from PV panels in response to extreme weather conditions, anti-islanding (AI), the ride-through of distributed grid faults, etc., can be accomplished by properly controlling the PV converters.

1) *Requirements for PV DPGS:* Distributed PV power-generation systems are being rapidly developed. In some countries, such as Germany, a large proportion of the electricity generation is from distributed PV systems, and the proportion continues increasing [50]–[57]. Although the continuous deployment of PV DPGS to some extent resolves the high energy demands across the globe, the variability and nondispatchability of PV DPGS (similar to the Wind DPGS) affect the stability and economical operation of distributed grids.



**Fig. 9. PV power-system-based DPGS, where the block “Generator” represents the PV panels that generate power via the photoelectric effect.**

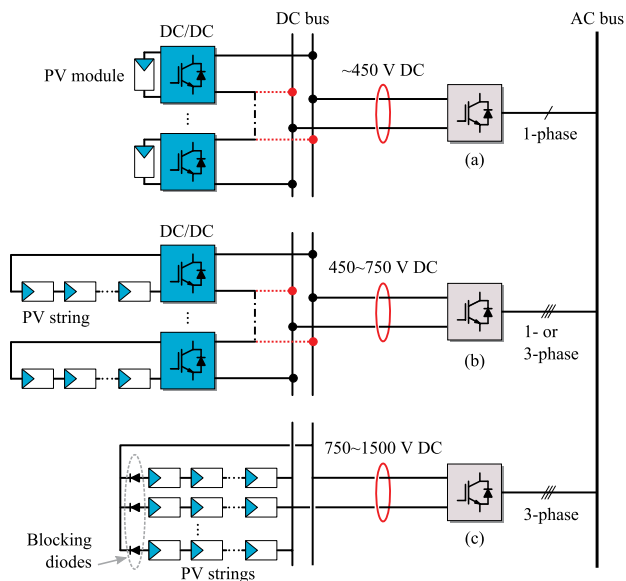


**Fig. 10. Demands for PV power-system-based DPGS, where  $P_{in}$  is the active power generated by PV panels, and  $P_o$  and  $Q_o$  are the active and reactive power exchanges between the converter and the grid, respectively.**

To ensure the reliable, efficient, and less harmful transfer of solar PV energy to the distributed grid, the PV DPGS must comply with far stricter requirements than ever before [51], [52], [58]. Fortunately, the control of PV power electronic converters can enable these functions by using smart inverters [53]–[57]. In general, the demands of the PV DPGS can be categorized into three types, as shown in Fig. 10.

First, as previously mentioned, the power capacity of the PV power-generation system is not as large as that of the wind power system. Moreover, the power characteristic of the PV DPGS is compatible with the behavior of the distributed grid; thus, the requirements are easier to satisfy than those of the Wind DPGS. For the PV side (i.e., the power generator side), the current or voltage of the PV panels should be controlled to capture as much energy as possible. That is, the MPPT control should be performed for all PV DPGSs, regardless of the power rating. The power rating determines the configuration of PV power systems, as shown in Fig. 11. In some cases, dc–dc power converters are required. Nonetheless, as the PV panels are degraded or develop growing defects during operation, panel-level diagnosis and monitoring are also necessary for the PV DPGS. For the grid side (i.e., the distributed grid side), the requirements are not as stringent as those for the wind DPGS; however, the power quality should normally be maintained at a satisfactory level. The similarities between the PV DPGS and the Wind DPGS for the distribution grid side include: 1) stabilizing the distribution grid voltage by providing ancillary services; and 2) riding-through grid voltage faults. Both are related to the grid resilience of the DPGS.

The power capacity per generating unit is low, but the cost of energy is currently high; thus, there is great demand for high-efficiency power conversion in order to achieve an acceptable price per produced kWh for the PV DPGS. In addition, as the power electronic converter is the core, similar to the wind DPGS, the reliability of PV power converters is important, and also it is motivated by extending the total energy production (service time) and reducing the cost. Finally, owing to exposure to a smaller housing chamber, the PV power converters must be more temperature insensitive,



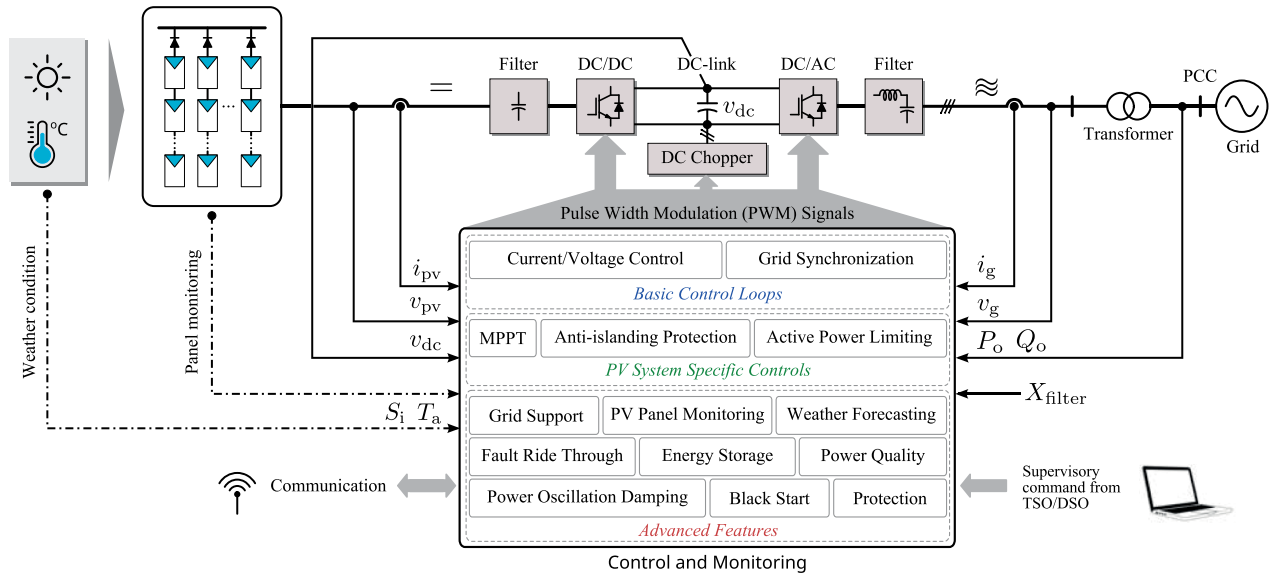
**Fig. 11. Connecting PVs to the ac grid (dc bus connections can be in series or in parallel): (a) module PV inverter for low-power applications; (b) string inverter for medium-power applications; and (c) central inverters for commercial or utility-scale systems. DC–DC converters for the string inverter are optional. For high-voltage PV systems (e.g., 750–1500-V dc), transformers are required.**

which otherwise may accelerate the degradation. Therefore, proper temperature management may be needed for the PV DPGS. Additionally, to enhance the operation at a system level (coordinated control), communication is essential.

2) *PV DPGS Concepts*: Most of the aforementioned demands for the PV DPGS can be realized by the control of the power electronic systems, i.e., PV inverters. Hence, an overview of the basic configurations for connecting PV panels to alternating current (ac) networks is presented in Fig. 11. As previously discussed, unlike the wind power technology, the solar PV produces far less power per generating unit (e.g., a single PV panel or string). Therefore, the PV DPGS normally consists of many panels or strings connected in parallel and/or series in order to increase the output power within an acceptable range, as shown in Fig. 11(b) and (c). In these two cases, the string/multistring inverters and center inverters are adopted as the interface to the distributed grid.

The central inverter technology is the most widely adopted alternative for distributed power grids, as it is the simplest way to collect dc power from PV panels with a low construction cost. However, there are significant drawbacks for this configuration, including the following:

- high dc-link voltage (750–1500 V);
- long dc cables (power losses);
- losses due to a common MPPT and mismatch of panels;
- losses and reliability of the diodes;
- reliability of the DPGS depending on one inverter.



**Fig. 12. General control structure of a PV power system connected to the distribution grid ( $i_{pv}$ : PV output current,  $v_{pv}$ : PV output voltage,  $v_{dc}$ : dc-link voltage,  $S_i$ : solar irradiance level,  $T_a$ : ambient temperature,  $i_g$ : grid current,  $v_g$ : grid voltage,  $X_{filter}$ : filter impedance).**

Nevertheless, for a high-power and high-voltage PV DPGS, multilevel power converters can be employed. In addition, several central inverters can be connected in parallel to increase the power-generation flexibility.

3) *General Control of PV DPGS*: According to the demands shown in Fig. 10, and according to the previous discussions, the PV DPGS should be controlled to perform these functions reliably and efficiently. Although the variability of the PV inverter topologies and system configurations increases the control difficulty, the general control objectives for a PV DPGS system are universal, including MPPT, grid synchronization, voltage/current control, active power control, AI protection, system condition monitoring (e.g., PV panels), and ancillary services (especially for resilience enhancement), as summarized in Fig. 12. With the increasing PV capacity, the power flowing in and out of the PV DPGS must be managed using other systems (e.g., energy storage systems) or even through itself; otherwise, the distributed grid voltage level and frequency may be violated. As previously mentioned, the entire Wind DPGS must follow the set-point commands given by the DSO for system stability concerns. This also applies for the PV DPGS.

That is, the more advanced features required for the Wind DPGS in the past are now considered for the PV DPGS, as the power capacity is drastically increasing in many areas. For instance, delta power production control, frequency control through active power, voltage control through reactive power, the ride-through operation of the distributed grid faults, and the provision of grid support in both normal and abnormal conditions to the grid have been adopted [57]–[60]. Typically, those features can be implemented in the control loops of the power converters. Regarding the fault ride-through operation, because the PV DPGS has far

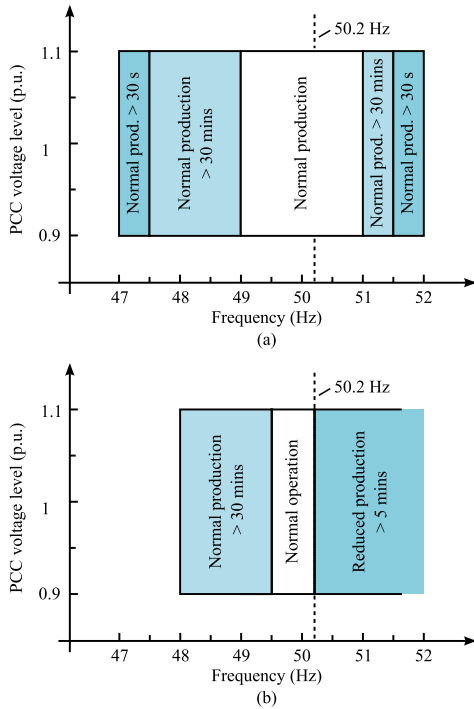
lower physical inertia (no rotating components) than the Wind DPGS, the control is simpler. However, in this case, the excessive active power from PV generators should be dispatched by 1) modifying the MPPT control; 2) activating the dc chopper to absorb power; and 3) managing the power exchange between the PV panels and the extra energy-storage systems. Notably, in these cases, the basic functions, such as current regulation, dc-link voltage stabilization, grid synchronization, and AI, must be quickly performed. Regarding resilience enhancement, the high-level coordinative control and operation among various DPGS may also be needed.

### III. RESILIENCE-RELEVANT DEMANDS AND CONTROL STRATEGIES

Renewable energy sources are variable, uncertain, and non-dispatchable. Consequently, the DPGS based on wind and PV resources may create severe issues, especially in response to extreme weather and in variable working conditions. This property is referred to as the resilience of the DPGS. The resilience of the DPGS characterizes the capacity to tolerate disruptions and the ability to recover from events [19]–[21]. To enhance the grid resilience, there are major three steps: 1) distribution grid planning; 2) enhanced operation; and 3) emergency management. Fig. 13 shows possible operational sequences of a typical DPGS. Many control demands at the converter level and/or system level are related to the resilience of the distribution grid during the operation or in contingent situations. In normal operation mode, the DPGS should be controlled at the converter level, while it should also be coordinated among the entire distribution system. In the case of unexpected temporary grid incidents, the grid voltage level may decrease significantly. During this

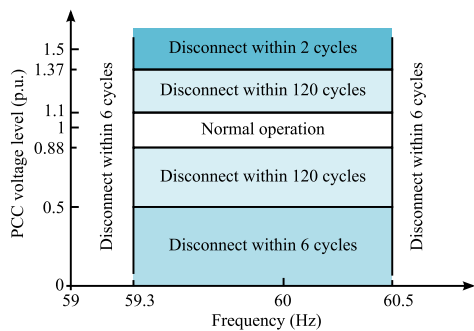




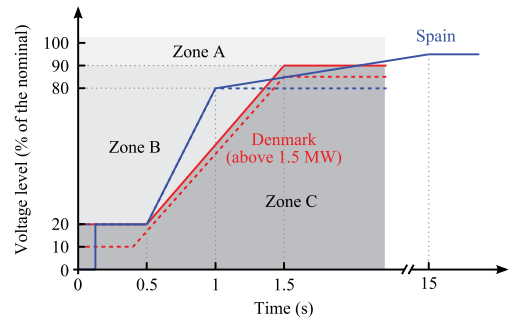


**Fig. 14. Examples of frequency and voltage operational windows for wind DPGSs in (a) Denmark (power above 50 kW) and (b) China [61], [63]. When the frequency and voltage of the grid at the PCC are outside the indicated regions, disconnecting the wind DPGS within specified time durations is required.**

the output power, which is known as MPPT control. At the same time, the power quality should be maintained, e.g., a total harmonic distortion (THD) level lower than 5%. However, when a PV DPGS with a higher power capacity is connected to MV/HV distributed networks, the story may be revised. In this case, the power injection from the PV DPGS can significantly affect the frequency and voltage profiles of the distributed grid. As a result, similar measures for the PV DPGS should be taken in order to regulate the frequency and voltage.



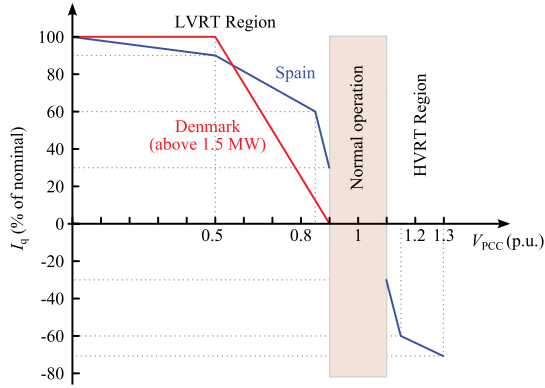
**Fig. 15. Example of the voltage and frequency windows for the PV DPGS in the IEEE Std 929-2000 [64], where the time to disconnect the PV DPGS is indicated.**



**Fig. 16. Voltage profiles in the case of LVRT for wind (solid lines) and PV DPGSs (dashed lines) in Spain (blue) and Denmark (red) [61], [62], [65].**

Furthermore, owing to various eventualities (e.g., climate related lightning strike and short circuit), the distributed grid may enter a faulty condition. In this case, the distributed grid voltage can be increased or decreased (i.e., voltage swells or sags). As more renewables (wind and PV) have been connected to the distributed grid, the grid code requires the DPGS to ride through grid faults (low- and high-voltage faults) for the stability concerns of the entire distributed network [61], [62], [65]. Fig. 16 exemplifies the low-voltage ride through (LVRT) for DPGSs in Spain and Denmark. Generally, the LVRT requirements can be divided into three zones. Taking the requirement for the Wind DPGS in Denmark as an example, in zone A, the DPGS should remain connected to the distribution grid and maintain the power production. When the distributed grid voltage level is in zone B, the Wind DPGS must also stay connected to the grid. Simultaneously, the DPGS must provide maximum voltage support by injecting reactive currents. The reactive-current support is for stabilizing the entire faulty distributed grid. In contrast, the wind DPGS is allowed to disconnect only when the grid voltage level sags into zone C (or the fault duration exceeds the limit), as shown in Fig. 16. Similarly, in the case of high-voltage ride through (HVRT), in some countries, the DPGS should also remain connected and be able to provide reactive current support upon demand. Nevertheless, when the grid fault is cleared, the production of the DPGS should be resumed at a limited rate.

As previously mentioned, reactive currents from the DPGS are required in the case of distributed grid faults. Fig. 17 shows examples of the required reactive current delivery in Denmark and Spain in the case of fault ride-through operation [61], [62], [65]. When the voltage level exceeds the range (0.9–1.1 p.u.), the reactive-current supply is prioritized to support the distributed grid voltage recovery. During these periods, the active power production should be maintained if possible, but this is not required, because it may trigger the inverter protection. Additionally, in extreme conditions, recurring faults may occur; in this case, the DPGS should also stay connected within certain defined periods [61], [62]. Overall, the fault ride-through operation is a scheme for tolerating voltage dips and rises in the distributed



**Fig. 17. Reactive current  $I_q$  demands for DPGSs in Spain (blue) and Denmark (red) [61], [62], [65], where  $I_q$  is the required current during the grid fault and  $V_{PCC}$  is the voltage level at the PCC.**

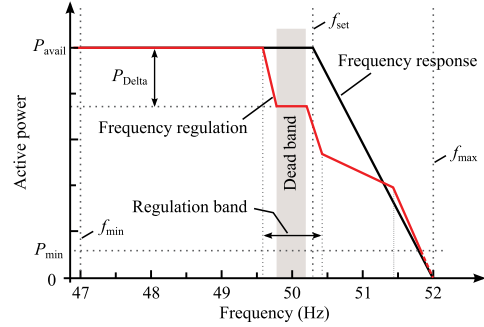
grid and thus preventing the collapse of the entire system. Considerable research has focused on the fault ride-through capability [8], [14], [41]–[46], [58], [66]–[68], which can be achieved through the control of the power electronic converters of the DPGS. Notably, depending on the system structure, in some cases, extra equipment may be required to assist the DPGS to ride-through grid faults.

### B. Frequency and Voltage Regulation

As renewable energy sources are variable and uncertain, the injection of fluctuating power by the DPGS can affect the stability of the distributed grid. Either the grid frequency or the voltage level may be outside the boundaries, as previously discussed. In the case of frequency deviations, the DPGS should be able to automatically change the active power production and must also perform frequency control in order to stabilize the distributed grid frequency. These are known as frequency response and frequency regulation, respectively, and are achieved through the frequency-active power droop relationship.

Fig. 18 shows the frequency response and frequency control curves for the DPGS in Denmark. The DPGS should be able to reduce the active power production in the range of 2%–12% of the nominal power [61], [62], according to any critical frequency point ( $50 \text{ Hz} \leq f_{set} \leq 52 \text{ Hz}$ ; typically, the frequency is set as  $f_{set} = 50.2 \text{ Hz}$ ). Upon demand, the DPGS must also enable the frequency-control functions, as demonstrated in Fig. 18. That is, all the frequency points and thus the droop curves should be implemented when the frequency is measured. Clearly, an accurate frequency measurement is necessary to ensure stable operation and fast dynamics.

In addition, to further alleviate the impacts of the fluctuating power generated by the DPGS, different active power control constraints have been introduced in recent grid codes. As stated in [61] and [62], these active power control functions are defined in order to prevent the instability or

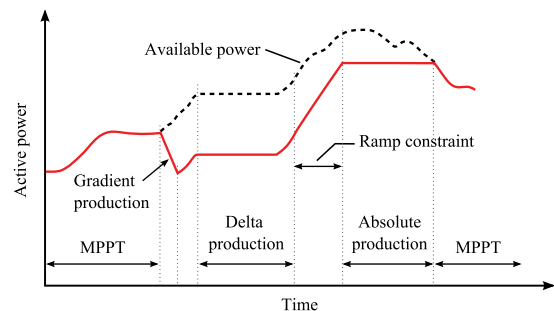


**Fig. 18. Frequency response and frequency regulation profiles for the DPGS in Denmark [61], [62], where  $P_{avail}$  is the present available power,  $P_{min}$  is the minimum power,  $P_{Delta}$  is the power difference,  $f_{set}$  is the frequency set by the TSOs, and  $f_{min}$  and  $f_{max}$  are the minimum and maximum distributed grid frequencies, respectively.**

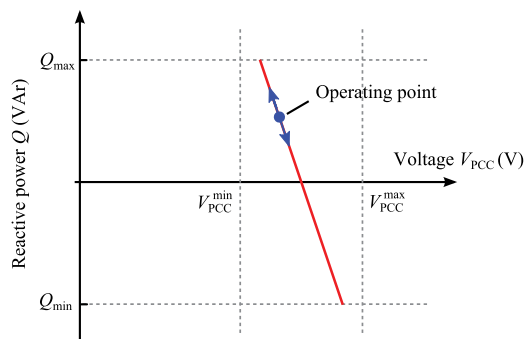
overloading of the distributed grid. For example, it is necessary to keep the active power constant during wind-speed changes (or solar-irradiance changes) or limit the ramp rate of the active power. Fig. 19 presents different constraint functions required for the Wind and PV DPGSs, where the absolute production constraint, the delta production constraint, and the power gradient constraint are also included. Notably, all these active power constraints can be realized through the control of the power electronic interfaces in the DPGS.

Another grid-stability index is the voltage level. The reactive power exchange between the distributed generators and the distributed grid can change the voltage profile at the point of common coupling (PCC). By controlling the reactive power, the voltage level is regulated, which is known as automatic voltage regulation (AVR). In general, the reactive power requirement is usually expressed in three different ways [61].

- Q control. In this control function, the reactive power should be controlled independently of the active power at the PCC.
- Power factor control. The reactive power is controlled proportionally to the active power at the point of connection, which results in a constant  $\cos\phi$ , where  $\phi$  is the power angle.



**Fig. 19. Different active power control functions for the DPGS to ensure grid frequency stability [61], [62].**



**Fig. 20.** Example of the reactive power control for voltage regulation [61], [62], where  $Q_{\min}$  and  $Q_{\max}$  are the minimum and maximum reactive power, respectively;  $V_{PCC}$  is the voltage level at the PCC; and the superscripts “min” and “max” represent the minimum and maximum values of  $V_{PCC}$  respectively.

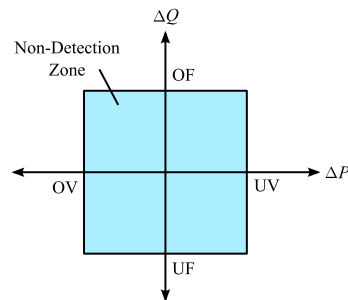
- Voltage control. This function controls the voltage at the voltage reference point by changing the reactive power generation. Fig. 20 shows an example of the voltage control through the reactive power adjustment of the DPGS.

The reactive power control and voltage control functions are mutually exclusive, which means that only one of the three aforementioned functions can be activated at a time. There are several additional power control functions defined for the DPGS. All of these are designed to ensure the frequency and voltage stability of the DPGS.

### C. Unintentional Islanding

Unintentional islanding can be one of the main technical issues for Wind and PV DPGSs. Islanding operation occurs when the power supply from the main distributed grid is interrupted—which can happen for several reasons—but the DPGS continues to supply power to the networks or the local loads. Islanding operation results in 1) retripping the line or damage to connected equipment due to the out-of-phase closure; and 2) safety hazards for distributed-system personnel that assume de-energized lines during the islanding. Islanding occurs more easily in highly penetrated DPGS networks. To avoid these serious consequences, safety measures called AI requirements have been issued and embodied in the Wind and PV DPGSs [69]. The main approaches for islanding detection include the following.

- Grid-resident detection—requiring either an advanced communication system or an external switched capacitor at the PCC, which increases the entire system complexity and costs.
- External switch capacitor detection—based on the concept that an external capacitor being periodically switched on in parallel with the grid produces a zero-crossing delay proportional to the grid impedance.



**Fig. 21.** Non-detection zone to assess the AI control methods for DPGS (UV—under voltage, OV—over voltage, UF—under frequency, OF—over frequency), where  $\Delta P$  and  $\Delta Q$  are the real and reactive power outputs of the grid, respectively.

- Inverter-resident detection—relying exclusively on software implementation inside the DPGS control system, which does not require any hardware modification.

As discussed in Section II, power electronic converters are widely used in DPGSs. Hence, the inverter-resident detection approach has gained popularity. Commonly, it can be categorized into three groups: passive detection, active detection, and hybrid solutions (combination of passive and active detection). The reliability of the islanding detection methods can be represented by the non-detection zone (NDZ) defined in the power mismatch space, where the islanding is not detectable and there is potential for parasitic trips. Fig. 21 shows the NDZ. Different AI detection methods are presented as follows.

1) *Passive Islanding Detection Methods—Under/Over Frequency (UF/OF) and Under/Over Voltage (UV/OV) Islanding Detection:* Voltage and frequency monitoring of the distributed grid is typically performed in order to trip the inverter in case of UF/OF or UV/OV protections. The worst case for islanding detection is represented by the condition where the active power and reactive power are balanced, in which there is no change in the amplitude or frequency. The passive methods have several advantages, such as a low cost and a simple and straightforward structure, as only the monitored voltage and frequency are used. This results in a large NDZ, which can be precisely determined in practice. However, in most cases, passive islanding detection is considered insufficient for AI protection in the DPGS.

2) *Active Islanding Detection Methods—Generation of Small Perturbations to Detect Islanding in PV Systems:* The active methods are based on the generation of small perturbations at the output of the DPGS inverter. Small changes in one of the power-system parameters (e.g., frequency, phase, and harmonics) can be identified. If islanding occurs, the small changes are amplified. Hence, compared with the passive methods, the active islanding methods can quickly detect islanding with a smaller NDZ. The most commonly

used techniques are a) frequency drift; b) voltage drift; and c) grid-impedance estimation (output-power variation). However, even small perturbations can push the distributed grid voltage and frequency out of the nominal range [9]. In the case of a weak network, the small changes can cause the instability of the entire distributed grid. Hence, further efforts should be directed toward designing proper active AI methods for large DPGSSs.

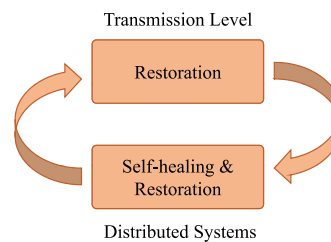
3) *Hybrid Islanding Detection Methods—Exploiting the Strengths of the Passive and Active Methods:* Here, the hybrid islanding detection overcomes the limitations of the active and passive techniques and exploits the advantages of these techniques. In most cases, passive detection is used to detect islanding first. If no clear disturbance is detected, perturbations are injected (i.e., active methods are enabled). However, this may lead to a larger NDZ.

When the distributed grid is down, the distributed generators (wind turbines or PV panels) may be required to power critical loads. In this case, islanding and grid-connected operation should be seamlessly switched. More importantly, the detection of the distributed grid failures and resynchronization are essential to the operation transition. Overall, distributed generation systems can operate in the islanded mode. To some extent, the employment of distributed generators improves the grid resilience, as critical loads can still be powered on when the distributed grid is under disruption.

#### D. Extreme Climate Disaster and Restoration

After a disaster, a resilient grid should be able to restore service to critical loads as soon as possible, including hospitals, street lighting, water stations, and other infrastructures that are associated with basic human needs [70]. However, a conventional restoration process usually is initiated at the transmission level and proceeds toward the distribution level, as shown in Fig. 22. Thus, load restoration is performed as the last step in the process. Because severe natural disasters, such as hurricanes, floods, thunderstorms, and blizzards, can impose a significant influence on the entire power system and may even damage the large and centralized power plants, bulk transmission lines, substations, and transformers [71], the conventional restoration strategies face many difficulties and take long time to complete the load restoration [72]. To cope with these challenges, new techniques, such as distributed-generation decentralized restoration strategies, may provide promising solutions for enhancing the resilience of the grids.

As previously mentioned, the DPGS can be isolated from damaged portions of the main distribution grid in the case of disruptions and sustain the power supply through the optimal management of multiple available distributed generation resources [73]. That is, the local generation, storage, and control of energy without the need for distant generating units and long transmission lines can make the DPGS less vulnerable to disasters and allow it to respond to



**Fig. 22. Coupled relationship of grid restoration and recovery between the DPGS and the transmission system.**

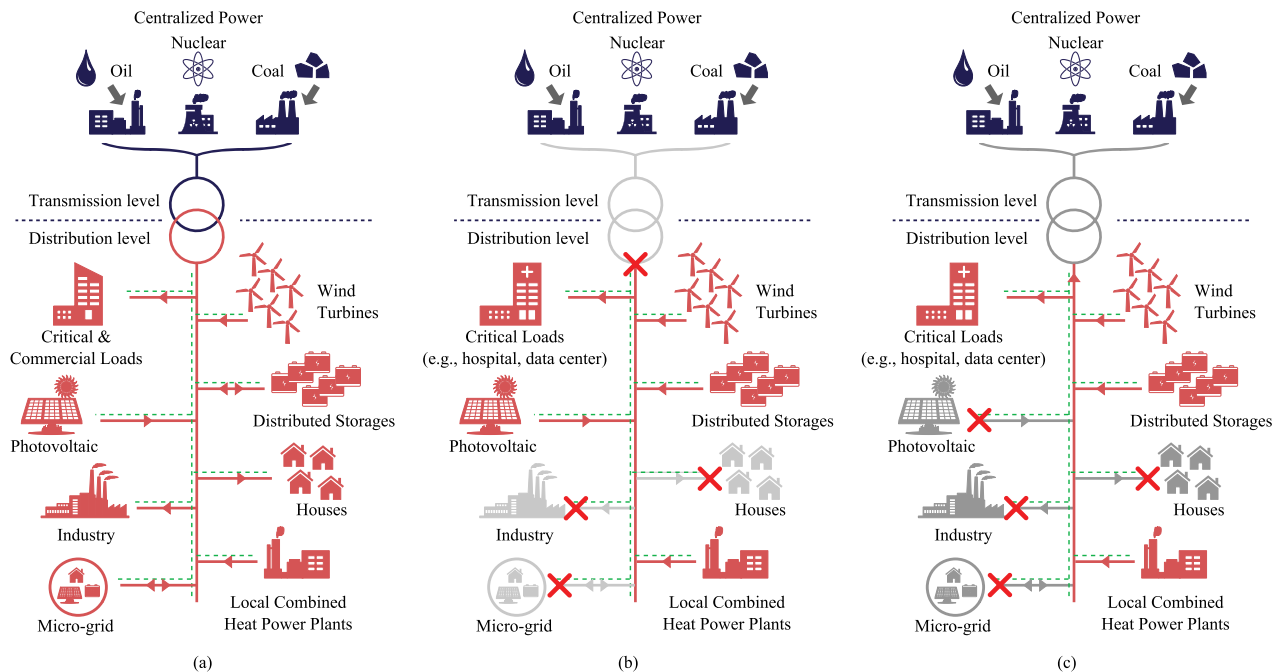
emergencies in a far more quickly and efficiently. Moreover, the DPGS can provide an initial source of power [74] during system restoration in cases where the main generation is unavailable or does not have black-start capability [75]. Therefore, with the help of the DPGS, the entire grid restoration can be started in a simultaneous bidirectional way, as shown in Fig. 22, which includes conventional top-down starting from the transmission level and bottom-up starting from the distribution side. This bidirectional restoration procedure can significantly shorten the restoration time and reduce the unserved electric energy during major grid failures [76]. Specifically, the DPGS can play an essential role in both aiding local critical load restoration and supporting upstream grid black start.

1) *Aiding Local Critical Load Restoration:* When DPGSs are used to restore critical loads after an extreme event, the major concern is to pick up more loads and reduce the restoration time. Several technical topics have been studied regarding distribution system service restoration in the presence of a DPGS, including the development of optimal energizing strategies and the enhancement of the restoration ability and reconfiguration algorithms.

To maximize the amount restored by the distributed generators, a multistage restoration procedure was proposed in [77]. The dynamic constraint of distributed generators and the limitation of the frequency deviation were considered. In [78], graphical theories were used in the DPGS-based load restoration procedure to serve more loads and reduce the switching operations. In [79], the sequence of actions was defined to coordinate multiple DPGSs for load restoration.

Because the centralized restoration strategies are highly dependent on the communication infrastructure and are prone to the single point of failure of the central controller, several decentralized methods have been proposed for enhancing the restoration ability. In [80], a multiagent system was proposed for load restoration to determine a feasible restoration path. In [81], a distributed algorithm was developed for load restoration in the consideration of fault detection, location, and isolation, as well as a practical load restoration procedure.

After an extreme event, multiple faults can damage the DPGS. Therefore, the reconfiguration of the DPGS can be exploited to limit the fault propagation and allow the load to



**Fig. 23. Examples of DPGS operations: (a) normal operation with frequency and voltage regulations; (b) islanded operation to power critical load; and (c) restoration operation under distribution grid failures or disturbance. The green dashed line represents communication links and the red lines with arrows represent distribution networks. The arrow indicates the direction of the power flow.**

be served by numerous electrical islands. In [82], a strategy for self-healing after natural disasters was proposed, which involved partitioning the distribution system into islanded DPGSs, as demonstrated in Fig. 23. In [83], a graph-theoretic restoration algorithm was designed to determine the optimal network configuration for a grid with distributed generators.

2) *Supporting Upstream Grid Black Start*: DPGSs can provide valuable energy to support the black start of the upstream grid. Compared with the local critical load restoration, the requirements for the DPGSs to be served as the initial black-start source are far higher in order to cope with the challenges of supporting upstream grid restoration.

When energizing the transmission lines, underground cables, and transformers, both sustained and transient overvoltages may be induced by the capacitive charging current flowing through them [84], [85]. Therefore, the distributed generators in the DPGS must have enough reactive power absorption capacity to absorb the reactive power during system restoration. Moreover, the DPGS must be able to withstand a voltage increase that may result from sustained or transient overvoltages.

In addition, large frequency deviations can occur when a large load, such as a transmission line, is switched on, which can trip the protective relays and lead to a failure of the restoration [86]. Thus, the DPGS should have a fast dynamic characteristic and be able to follow the load changes faster in order to avoid large fluctuations in the frequency and voltages.

Furthermore, the DPGS should be able to handle large inrush load currents at the start of the re-energizing process [87]. In this case, the role of the energy-storage elements in the DPGS, such as ultracapacitors, batteries, or flywheels, is very critical for maintaining the transient power balance of the entire system, as illustrated in Fig. 23.

In summary, by integrating distributed generators into distribution networks, the restoration capability can be improved, along with the flexibility of the operation of the entire DPGS. Fig. 23 further exemplifies the operation flexibility of a power grid with distributed generators. According to Figs. 13 and 23, when there are disruptive events in the distribution and/or transmission networks, the entire power grid may be shut down to protect 1) the downstream equipment; 2) the distribution network; and 3) the upstream power grid. In the restoration period, the distributed generators, together with energy-storage elements and local combined heat power plants, may contribute to the grid recovery. This depends on the capacity of the distribution network. For PV systems, because there is no physical mass, the restoration contribution may be limited, as shown in Fig. 23. Notably, if the distribution grid cannot be restored, it can be changed to operate in the islanded mode in order to power critical loads in the system and prevent fault propagation to adjacent networks. In this case, all the distributed energy resources can be put into operation. Notably, as shown in Fig. 23, communication and coordination are important.

#### IV. DPGS PROTECTION

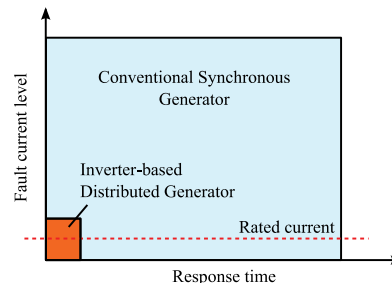
As the penetration of renewable-based DPGSs increases, traditional SGs are being excluded from the grid. Thus, protection and coordination issues must be properly addressed. Actually, the system protection has been defined in national grid codes [61], [62], which state that the protective function is mainly to protect the distributed generator (e.g., wind power plants) and the upward distribution grid from collapse.

##### A. Protection Issues in DPGS

The major problem when integrating distributed generators into the distribution power grid is that the distribution systems are designed as radial networks, delivering the power in a unidirectional way: from substations to consumers [88]. The coordinated operation of circuit breakers with overcurrent relays, reclosers, and fuses to protect this unidirectional radial power grid from both temporary and permanent faults has been well established [89]. However, with a high penetration of distributed generators, new multisource networks become active and are no longer radial, and the conventional protection is unsuitable for a high penetration level of distributed generators. The main impacts of the operation of distributed generators on the distribution system protection are as follows.

1) *Fault-Current Contribution*: In the conventional network based on SGs, phase-phase or phase-ground faults normally result in an overcurrent. As exemplified in Fig. 24, the fault current is significantly higher than the operational or nominal (rated) current, which is the basic precondition for traditional overcurrent-based protection techniques. However, owing to the limited current rating of power electronic devices, the fault current of the predesigned power converter-interfaced DPGS is normally limited to a maximum of about twice the nominal current [90]. Therefore, the fault current measured by the feeder protective relay, which is located at the front end of the feeder, decreases drastically compared with the case where no distributed generators are connected to the network. This may result in the delayed operation of the relay in order to detect the faults. Because of the fault-current contribution from the DPGS, the fraction of the fault currents measured by the overcurrent relays decreases. This reduction may cause the malfunction of the overcurrent relays [91]. In the worst case, the fault is not detected instantly. This can lead to high voltages, although the fault currents are low. Moreover, if the fault remains undetected for a long period, it can spread throughout the entire distributed system and thus induce severe damage to equipment. Additionally, as indicated in Fig. 24, distributed generators employing power converters can react to grid disturbances very fast. This may alleviate the impact of overloading on the distributed-grid components [9].

Notably, the fault-current contribution from inverter-based distributed generators depends on the sizing of the



**Fig. 24. Comparison of the fault-current contributions from a conventional synchronous generator and an inverter-based distributed generator.**

power electronic converters. To increase the fault-current detection capability, the inverters must be oversized, which incurs additional costs. This means that a tradeoff between the protection capability and the overall system cost should be made during the planning phase. Additionally, cost-effective protection schemes should be developed.

2) *Reduction in Reach of Impedance Relays*: The reach of an impedance relay is the maximum fault distance that triggers the relay in a certain impedance zone or in a certain time because of its configuration. This maximum distance corresponds to a maximum fault impedance or a minimum fault current that is detected [92]. In case of a fault that occurs downstream of the bus where the DPGS is connected to the utility network, the impedance measured by an upstream relay is higher than the real fault impedance. This is equivalent to an apparently increased fault distance, which is due to the increased voltage resulting from an additional infeed at the common bus. As a consequence, the relay may be triggered with a faster grading time response [93].

3) *Auto Reclosure*: For a temporary fault in the distributed grid, reclosers are intended to operate in a fast mode, isolate the faulty feeder, and allow the fault to self-clear. To secure the proper operation of automatic reclosing and prevent out-of-phase reclosure, distributed generators must be disconnected completely before the reclosure [94]. When a distributed generation unit continues to operate after a single fault, two problems may arise if the utility reconnection (i.e., automatic reclosure) is initiated after a short interruption. First, the fault may not have been cleared, as the arc was fed from the distributed generation unit. As a result, the instantaneous reclosure may not succeed. Second, because of the active power unbalance, the frequency may change in the islanded part of the distribution grid. In this case, an attempt to reclose the switch will couple two asynchronously operating systems with active sources on both sides of the recloser, which results in the failure of the reclosure [95].

To make the protection schemes work effectively and reliably in the presence of DPGSs, the following key technical challenges should be well addressed.

- Unique fault characteristics of the distributed generators—Because the short-circuit current levels of different distributed generators vary greatly depending on the oversizing and control, it is desirable to accurately model the transient characteristics of the current and voltage when a single fault or multiple faults occur in DPGSs.
- Highly adaptive fault identification algorithms—Because the DPGS can be operated in different modes (see Fig. 23) and its network can be reconfigured dynamically, adaptive fault identification algorithms that can effectively detect the change of the operational modes and network configurations and accordingly adjust the protection scheme in an adaptive manner are of great interest.

## B. DPGS Protection to Improve Resilience

Protection for the DPGS is essential to enhance the grid resilience by quickly identifying the fault and then isolating faulty components with little human intervention. In recent years, different protection schemes have been proposed for improving the reliable protection when the DPGS is operating either in the islanded or grid-connected mode, aiming to protect the distributed generation sources and network within the DPGS, as well as the upstream grid network. This section briefly reviews the available protection schemes, which are categorized into six different types, as shown in Fig. 25.

1) *Voltage-Based Protection*: Fault detection in the case of low-fault current networks can be achieved using voltage-source components. It is possible to calculate the values of voltage-source components for different types of faults [96]. The common practice is to monitor the output voltages of the distributed generation sources and then transform the three-phase ac voltages into dc quantities using the Park and Clarke

transformations [97]. Using the dc values, the disturbance signal can be calculated as the deviation of the voltage signal from a given reference. In the case of an asymmetrical fault, the dc components exhibit a ripple. Therefore, these components are first filtered out using notch filters. Then, they are compared with the references. In [98], a fault-detection method based on the monitoring of the positive sequence component of the fundamental voltage was proposed. Using this method, both symmetrical and asymmetrical faults in the DPGS can be detected. In [99], a technique for differentiating between three-phase, two-phase, and single-phase faults was presented. This scheme is suitable for DPGSs with a high penetration of distributed generators in islanded operation.

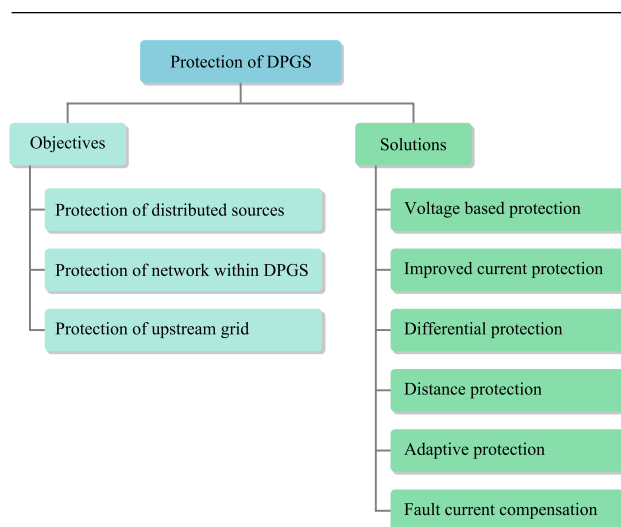
Numerous problems should be considered when implementing the voltage-based scheme for DPGS protection. The performance of the schemes can suffer owing to time delays and filtering processes. Moreover, the detection time changes depending on the type of the fault and the magnitude of the voltage depth during the fault occurrence. Finally, the scheme is highly dependent on the operational mode of the DPGS. Improper protections can be triggered by voltage fluctuations caused by nonfault events in islanded operation; the scheme is more robust in the grid-connected operational mode.

2) *Improved Overcurrent Protection*: To protect the power electronic device of the DPGS, the overcurrent protection should consider the device rating. Any fault in the DPGS must be cleared without relying on high fault currents.

Using symmetrical current components, an islanded DPGS can be protected against single line-to-ground and line-to-line faults [100]. A symmetrical approach for protection was proposed in [101]. The protection scheme utilizes a zero-sequence component to detect single-line-to-ground faults; the negative-sequence current is used to identify the line-to-line faults.

Furthermore, overcurrent protection schemes may benefit from the communication in the DPGS [102]. A symmetrical component-based scheme was proposed, which relies on communication and can locate both symmetrical and asymmetrical faults in a timely manner. The communication is established only for exchanging status information and not electrical measurements; thus, the required communication bandwidth is reduced [103]. Another instantaneous overcurrent-based scheme was developed [104], where an optical Ethernet cable was adopted. This scheme offers instantaneous protection for local lines and remote bus bars using two executive routines, regardless of where the distributed generators are located.

The main problems with these protection schemes are related to the high dependence on wide-area communication systems. Obviously, communication reliability problems can affect the protection performance. That is, in the case of a failure in the communication system, the entire protection scheme may be dysfunctional [105].



**Fig. 25. Categorization of the protection for DPGSs.**

3) *Differential Protection*: Differential protection is based on comparing the currents entering and leaving the protected zone. As long as the difference between these currents exceeds a predefined fault value, the relays send a signal to the distribution generation source at the faulty zone, and then the protection is enabled. Differential protection has the fastest response time—approximately 5 ms—and the fault value of the differential protection can easily be resolved. Moreover, it can be modified for both modes of operation, which makes it suitable for the protection of DPGSs [106].

In [101], differential protection was used together with symmetrical-component calculations to detect faults and determine fault types. In [107], differential relays were used to protect a DPGS in both grid-connected and islanded modes. By employing digital relays with communication, a differential protection scheme was developed in [108]. It addresses the problem of high impedance faults and is suitable for DPGSs with radial and meshed networks. In [109], the differential features were extracted from the fault current and voltages using the discrete Fourier transform, and a decision-tree data-mining model was developed to make the final decision. To reduce the cost of devices for differential protection, the optimal placements of protection zones and the protective devices for each zone were explored in [110].

A significant benefit of the differential protection principle for protecting the DPGS is that it can overcome the problems of a low fault-current level and a reverse power flow. However, protective devices must usually be installed at each line, and these devices rely on the communication infrastructure to receive measurements. This incurs additional costs and introduces communication reliability problems. Moreover, synchronized measurements are required, and unbalanced loads and transients may challenge the protection.

4) *Distance Protection*: Distance protection utilizes impedance/admittance measurements to effectively detect faults and then perform trip actions. The protection scheme was first developed by Dewadasa for DPGS protection in both grid-connected and islanded operation modes [111], [112]. In this scheme, faults are detected by employing a new type of admittance relay that has the characteristics of inverse time tripping. The main advantage of distance schemes is that they are not affected by changes in the current levels, as they mainly depend on the measured impedance.

A new scheme with two procedures for main and backup protection was established using the extracted impedance [113]. The first procedure is required to identify the fault occurrence and provide a time reference for the exchanged data. The latter operates in an automatic coordinated manner with an inverse-time characteristic to provide backup protection. In [114], the distance-protection approach for protecting the MV DPGS in both grid-connected and islanded modes is presented. Compared with the traditional

overcurrent protection, the features of the distance protection change very little, even in different operational modes.

Distance protection also has drawbacks. During faults, the distributed generators located between the fault point and the measurement point act as intermediate in-feeds, which affects the accuracy of the measurements and hence the performance. Moreover, the fault resistance can affect the measured impedance. Finally, current transients, harmonics, and decaying dc currents have significant effects on the accuracy of the measurements.

5) *Adaptive Protection*: To fully utilize the DPGS for improving the grid resilience, the DPGS must usually operate reliably in both the grid-connected mode and the islanded mode. Thus, the mode transition has a significant impact on the protection scheme, and the design of the protection scheme is very challenging. Recently, adaptive protection schemes have been presented as promising solutions for DPGS protection in the case of a high penetration level. Such schemes allow the online adjustment of both the relay settings and the characteristics using external signals [115].

In [116], an adaptive fault current protection algorithm was developed by analyzing the fault behavior of a power converter-based DPGS. In this method, the settings of the instantaneous overcurrent protection scheme are automatically adjusted for the new situation by comparing the system impedance with the DPGS impedance. Another adaptive protection scheme using energy storage and isolation transformers was proposed in [117]. The protection scheme adaptively switches between overcurrent protection in the grid-connected mode and voltage-based protection in the islanded mode. The mode transition is ensured by comparing the zero sequence impedance angles.

In [118], an algorithm based on numerical relays was proposed to coordinate different relays in a specific microgrid. The overcurrent relay settings are calculated offline and then stored in the relays. The scheme has the ability to detect faults with far smaller short-circuit levels in the DPGS. In [119], an adaptive overcurrent protection strategy consisting of a real-time conventional block was introduced. An adaptive protection system that monitors and updates the setting of relays online according to the operating modes of the DPGS was proposed in [120]. It employs communication links to collect data from intelligent electronic devices, and then the data are sent to a centralized controller for real-time analysis. A new adaptive scheme based on a centralized architecture was presented [121]. It performs offline fault calculations to determine the directional and non-directional overcurrent relay settings, which are then updated periodically.

Although adaptive relays provide flexibility, they have drawbacks. Replacing all the existing relays with adaptive ones is very expensive and requires the existing protection



**Table 1** Comparison of Different Protection Schemes for DPGS

<i>Protection Schemes</i>	<i>Advantage</i>	<i>Disadvantage</i>
Voltage-Based Protection	Suitable for low-fault current networks	Introduces time delays depending on fault type; highly dependent on operational mode of DPGS
Improved Current Protection	Fast; low fault-current level	Relies on communication
Differential Protection	Works effectively with low fault-current level and reverse power flow	Requires more protective devices; relies on communication; sensitive to unbalanced conditions
Distance Protection	Robust for different operational modes	Accuracy affected by fault location, fault resistance, current transients, harmonics, and decaying DC currents
Adaptive Protection	High flexibility for different DPGS configurations; adaptive to different operational modes	Expensive; relies on communication; complicated adaptive rules
Fault-Current Compensation	Compatible with conventional overcurrent protection	Requires significant investments

schemes currently used for distribution systems to be upgraded. Additionally, adaptive relays usually need communication infrastructures for reliable and fast operation. Moreover, prior-art knowledge of all possible DPGS configurations should be tuned according to the adaptive adjusting rules, which makes adaptive relays very difficult to implement in the case of large-scale DPGSs.

6) *Fault-Current Compensation*: Because the fault-current levels of the DPGS differ between grid-connected and islanded operation, especially with inverter-interfaced distribution generation, it is challenging to design a protection scheme that operates well in both modes. Hence, an additional fault-current source (FCS) can be used to compensate for the fault-current levels of different operational modes to the similar level, which allows the overcurrent protection to function well with the conventional method [122]. The synchronous condensers or the storage devices, such as flywheels, batteries, and ultracapacitors, can be used as FCSs for injecting high currents during faults [9]. The storage device-based FCS usually contains a storage element, a power electronic converter, a triggering circuit, and a charging module [123]. As soon as a fault is detected, the FCS is used to restore the system voltage, injecting as much current as necessary. Once the fault is cleared, the FCS is switched off. The major problem with fault-current compensation in the DPGS is that it requires significant investments.

## V. CONCLUSION

The technological developments in DPGSs were explored. It was revealed that the DPGS-based wind and PV technologies will be dominant in the future market and in future power systems. This paper first provided an overview of

the power electronic technologies for wind and PV DPGSs, as the power electronics are the core of the energy conversion. More importantly, as the wind and PV energies are variable, uncertain, and nondispatchable, connecting these renewables to the distributed grid may cause instability. Therefore, stringent demands have been placed on the DPGS. These were also reviewed in this article, and control strategies were discussed. The investigation revealed that multiple control functions can be provided by the DPGS in order to improve the reliability, performance, and resilience of the entire grid. The constraints can be implemented by properly controlling the power electronic converters of the DPGS. This has become one important aspect for inverter-based DPGSs. However, it also introduces side effects. As the inverter-dominated DPGS does not have much physical inertia, the DPGS must be oversized in order to provide a satisfactory amount of fault currents, which increases the total cost. Nonetheless, DPGS protection is challenging. In this paper, the challenging issues regarding the DPGS were summarized, and the state-of-the-art protection techniques that can be applied to the DPGS were reviewed. Table 1 lists the advantages and disadvantages of the protection schemes discussed for the DPGS.

It can be concluded that the DPGS can increase the grid resilience, as it can operate in both the grid-connected mode and the islanded mode. In the case of an islanded DPGS, critical loads can be supplied upon demand when the main grid is absent. Additionally, the DPGS can help to restore the transmission system after disruptions; in return, the DPGS benefits from the transmission grid when it must be restored after failures. Communication and data processing technologies may be critical for ensuring the reliable, efficient, and resilient operation of distributed grids. ■

## REFERENCES

- [1] International Renewable Energy Agency (IRENA). (Mar. 2016). *Renewable Energy Capacity Statistics*, accessed on Mar. 6, 2017. [Online]. Available: [http://www.irena.org/DocumentDownloads/Publications/IRENA\\_RE\\_Capacity\\_Statistics\\_2016.pdf](http://www.irena.org/DocumentDownloads/Publications/IRENA_RE_Capacity_Statistics_2016.pdf)
- [2] DAMVAD & Kariros Future. *DK2050: Green Growth in Denmark Towards 2050—Four Future Scenarios*, Mar. 6, 2017. [Online]. Available: [http://www.dac.dk/media/54231/Damvad\\_english\\_1007.pdf](http://www.dac.dk/media/54231/Damvad_english_1007.pdf)
- [3] European Commission. (2016). *Transforming the European Energy System Through Innovation—Integrated Strategic Energy Technology (SET) Plan Progress in 2016*. [Online]. Available: [https://ec.europa.eu/energy/sites/ener/files/documents/set-plan\\_progress\\_2016.pdf](https://ec.europa.eu/energy/sites/ener/files/documents/set-plan_progress_2016.pdf)
- [4] *Renewables 2016: Global Status Report*, accessed on Mar. 6, 2017. [Online]. Available: [http://www.ren21.net/wp-content/uploads/2016/10/REN21\\_GSR2016\\_FullReport\\_en\\_11.pdf](http://www.ren21.net/wp-content/uploads/2016/10/REN21_GSR2016_FullReport_en_11.pdf)
- [5] Danish Energy Agency. *Overview Map of the Danish Power Infrastructure in 1985 and 2015*, accessed on Mar. 6, 2017. [Online]. Available: [https://ens.dk/sites/ens.dk/files/Statistik/foer\\_etter\\_uk.pdf](https://ens.dk/sites/ens.dk/files/Statistik/foer_etter_uk.pdf)
- [6] Energinet.dk. *Electricity Generation*, accessed on Mar. 6, 2017. <http://www.energinet.dk/EN/KLIMA-OG-MLJØE/Miljøerapportering/Elproduktion-i-Danmark/Sider/Elproduktion-i-Danmark.aspx>
- [7] F. Blaabjerg, D. M. Ionel, Y. Yang, and H. Wang, “Renewable energy systems—Technology overview and perspectives,” in *Chapter 1 in Renewable Energy Devices and Systems with Simulations in MATLAB and ANSYS*. Boca Raton, FL, USA: CRC Press, 2017, pp. 1–16, 2017.
- [8] F. Blaabjerg and K. Ma, “Wind energy systems,” *Proc. IEEE*, to be published.
- [9] B. Kroposki et al., “Achieving a 100% renewable grid: Operating electric power systems with extremely high levels of variable renewable energy,” *IEEE Power Energy Mag.*, vol. 15, no. 2, pp. 61–73, Mar. 2017.
- [10] V. Knazkins, “Stability of power systems with large amounts of distributed generation,” Ph.D. Dissertation, TKH, Stockholm, Sweden, 2004.
- [11] M. A. Chowdhury, A. H. M. Sayem, W. Shen, and K. S. Islam, “Robust active disturbance rejection controller design to improve low-voltage ride-through capability of doubly fed induction generator wind farms,” *IET Renew. Power Gen.*, vol. 9, no. 8, pp. 961–969, Nov. 2015.
- [12] Y. Hirase, K. Sugimoto, K. Sakimoto, and T. Ise, “Analysis of resonance in microgrids and effects of system frequency stabilization using a virtual synchronous generator,” *IEEE Trans. Emerg. Sel. Topics Power Electron.*, vol. 4, no. 4, pp. 1287–1298, Dec. 2016.
- [13] S. K. Mazumder and E. Pilo de la Fuente, “Stability analysis of micropower network,” *IEEE Trans. Emerg. Sel. Topics Power Electron.*, vol. 4, no. 4, pp. 1299–1309, Dec. 2016.
- [14] Y. Yang, P. Enjeti, F. Blaabjerg, and H. Wang, “Wide-scale adoption of photovoltaic energy: Grid code modifications are explored in the distribution grid,” *IEEE Ind. Appl. Mag.*, vol. 21, no. 5, pp. 21–31, Sep./Oct. 2015.
- [15] T. N. Preda, K. Uhlen, and D. E. Nordgard, “An overview of the present grid codes for integration of distributed generation,” in *Proc. CIRED Workshop*, 2012, pp. 1–4.
- [16] T. Basso, “IEEE 1547 and 2030 standards for distributed energy resources interconnection and interoperability with the electricity grid,” Tech. Rep. NREL/TP-5D00-63157, Dec. 2014.
- [17] H. Margossian, G. Deconinck, and J. Sachau, “Distribution network protection considering grid code requirements for distributed generation,” *IET Generat., Transm. Distrib.*, vol. 9, no. 12, pp. 1377–1381, Sep. 2015.
- [18] F. Blaabjerg, K. Ma, and Y. Yang, “Power electronics—The key technology for renewable energy systems,” in *Proc. EVER*, 2014, pp. 1–11.
- [19] D. T. Ton and W. T. P. Wang, “A more resilient grid: The U.S. department of energy joins with stakeholders in an R&D plan,” *IEEE Power Energy Mag.*, vol. 13, no. 3, pp. 26–34, Jun. 2015.
- [20] M. Panteli and P. Mancarella, “The grid: Stronger, bigger, smarter?: Presenting a conceptual framework of power system resilience,” *IEEE Power Energy Mag.*, vol. 13, no. 3, pp. 58–66, Jun. 2015.
- [21] “The president’s council of economic advisers and the U.S. department of energy’s office of electricity delivery and energy reliability, with assistance from the white House office of science and technology economic benefits of increasing electric grid resilience to weather outages,” Tech. Rep., Aug. 2013. [Online]. Available: [https://energy.gov/sites/prod/files/2013/08/f2/Grid%20Resiliency%20Report\\_FINAL.pdf](https://energy.gov/sites/prod/files/2013/08/f2/Grid%20Resiliency%20Report_FINAL.pdf)
- [22] “2014 DOE resiliency electric distribution grid R&D workshop report,” Dept. Energy, Upton, New York, NY USA, Tech. Rep., Jun. 2014. [Online]. Available: <http://energy.gov/sites/prod/files/2014/07/f17/2014ResilientGridWorkshop-FinalReport.pdf>
- [23] H. H. Willis and K. Loa, “Measuring the resilience of energy distribution systems,” RAND Corp., Santa Monica, CA, USA, 2015. [Online]. Available: [http://www.rand.org/content/dam/rand/pubs/research\\_reports/RR800/RR883/RAND\\_RR883.pdf](http://www.rand.org/content/dam/rand/pubs/research_reports/RR800/RR883/RAND_RR883.pdf)
- [24] R. K. Varma, S. A. Rahman, and T. Vanderheide, “New control of PV solar farm as STATCOM (PV-STATCOM) for increasing grid power transmission limits during night and day,” *IEEE Trans. Power Delivery*, vol. 30, no. 2, pp. 755–763, Apr. 2015.
- [25] P. Loevenbruck, “Residential storage to improve system resilience: Technical design and cost estimation,” in *Proc. CIRED Workshop*, 2016, pp. 1–4.
- [26] X. Liu, M. Shahidehpour, Z. Li, X. Liu, Y. Cao, and Z. Bie, “Microgrids for enhancing the power grid resilience in extreme conditions,” *IEEE Trans. Smart Grid*, vol. 8, no. 2, pp. 589–597, Mar. 2017.
- [27] Z. Wang and J. Wang, “Service restoration based on AMI and networked MGs under extreme weather events,” *IET Generat., Transm., Distrib.*, vol. 11, no. 2, pp. 401–408, Jan. 2017.
- [28] M. Panteli, D. N. Trakas, P. Mancarella, and N. D. Hatziargyriou, “Boosting the power grid resilience to extreme weather events using defensive islanding,” *IEEE Trans. Smart Grid*, vol. 7, no. 6, pp. 2913–2922, Nov. 2016.
- [29] T. Kang, S. Choi, A. S. Morsy, and P. N. Enjeti, “Series voltage regulator for a distribution transformer to compensate voltage Sag/Swell,” *IEEE Trans. Ind. Electron.*, to be published.
- [30] J. Kim, E. Muljadi, J. W. Park, and Y. C. Kang, “Adaptive hierarchical voltage control of a DFIG-based wind power plant for a grid fault,” *IEEE Trans. Smart Grid*, vol. 7, no. 6, pp. 2980–2990, Nov. 2016.
- [31] R. Teixeira Pinto, M. Aragués-Peñalba, O. Gomis-Bellmunt, and A. Sumper, “Optimal Operation of DC Networks to Support Power System Outage Management,” *IEEE Trans. Smart Grid*, vol. 7, no. 6, pp. 2953–2961, Nov. 2016.
- [32] H. Farzin, M. Fotuhi-Firuzabad, and M. Moeini-Aghtaie, “Enhancing power system resilience through hierarchical outage management in multi-microgrids,” *IEEE Trans. Smart Grid*, vol. 7, no. 6, pp. 2869–2879, Nov. 2016.
- [33] F. Blaabjerg and K. Ma, “Future on power electronics for wind turbine systems,” *IEEE J. Emerg. Sel. Topics Power Electron.*, vol. 1, no. 3, pp. 139–152, Sep. 2013.
- [34] F. Blaabjerg, M. Liserre, and K. Ma, “Power electronics converters for wind turbine systems,” *IEEE Trans. Ind. Appl.*, vol. 48, no. 2, pp. 708–719, Mar./Apr. 2012.
- [35] M. Tsili and S. Papathanassiou, “A review of grid code technical requirements for wind farms,” *IET Renew. Power Generat.*, vol. 3, no. 3, pp. 308–332, Sep. 2009.
- [36] (Jan. 2003). *Energinet—Wind Turbines Connected to Grids With Voltages Below 100 Kv*, accessed on Mar. 7, 2017. [Online]. Available: <http://www.energinet.dk/EN/Sider/default.aspx>
- [37] *Grid Code—High and Extra High Voltage*, Tennet TSO GmbH, Dec. 2012.
- [38] *Requirements for Offshore Grid Connections in the Grid of Tennet TSO GmbH*, Tennet TSO GmbH, Dec. 2012.
- [39] K. Ma, H. Wang, and F. Blaabjerg, “New approaches to reliability assessment: Using physics-of-failure for prediction and design in power electronics systems,” *IEEE Power Electron. Mag.*, vol. 3, no. 4, pp. 28–41, Dec. 2016.
- [40] H. Wang et al., “Transitioning to physics-of-failure as a reliability driver in power electronics,” *IEEE J. Emerg. Sel. Topics Power Electron.*, vol. 2, no. 1, pp. 97–114, Mar. 2014.
- [41] R. Pena, J. C. Clare, and G. M. Asher, “Doubly fed induction generator using back-to-back PWM converters and its application to variable speed wind-energy generation,” *Electr. Power Appl.*, vol. 143, no. 3, pp. 231–241, 1996.
- [42] S. Müller, M. Deicke, and R. W. de Doncker, “Doubly fed induction generator systems for wind turbines,” *IEEE Ind. Appl. Mag.*, vol. 8, no. 3, pp. 26–33, May/June. 2002.
- [43] D. Xiang, L. Ran, P. J. Tavner, and S. Yang, “Control of a doubly fed induction generator in a wind turbine during grid fault ride-through,” *IEEE Trans. Energy Convers.*, vol. 21, no. 3, pp. 652–662, Sep. 2006.
- [44] F. K. A. Lima, A. Luna, P. Rodriguez, E. H. Watanabe, and F. Blaabjerg, “Rotor voltage dynamics in the doubly fed induction generator during grid faults,” *IEEE Trans. Power Electron.*, vol. 25, no. 1, pp. 118–130, Jan. 2010.
- [45] W. Chen, D. Xu, N. Zhu, M. Chen, and F. Blaabjerg, “Control of doubly-fed induction generator to ride-through recurring grid faults,” *IEEE Trans. Power Electron.*, vol. 31, no. 7, pp. 4831–4846, Jul. 2016.
- [46] D. Santos-Martin, J. L. Rodriguez-Amenedo, and S. Arnaltes, “Providing ride-through

- capability to a doubly fed induction generator under unbalanced voltage dips," *IEEE Trans. Power Electron.*, vol. 24, no. 7, pp. 1747–1757, Jul. 2009.
- [47] K. O. Kovanen, "Photovoltaics and power distribution," *Renew. Energy Focus*, vol. 14, no. 3, pp. 20–21, May/Jun. 2013.
- [48] Y. Xue, K. C. Divya, G. Griepentrog, M. Liviu, S. Suresh, and M. Manjrekar, "Towards next generation photovoltaic inverters," in *Proc. ECCE*, Sep. 2011, pp. 2467–2474.
- [49] J. D. van Wyk and F. C. Lee, "On a future for power electronics," *IEEE J. Emerg. Sel. Topics Power Electron.*, vol. 1, no. 2, pp. 59–72, Jun. 2013.
- [50] M. Braun et al., "Is the distribution grid ready to accept large-scale photovoltaic deployment? State of the art, progress, and future prospects," *Progr. Photovolt., Res. Appl.*, vol. 20, no. 6, pp. 681–697, Sep. 2012.
- [51] C. Whitaker, J. Newmiller, M. Ropp, and B. Norris, "Renewable systems interconnection study: Distributed photovoltaic systems design and technology requirements," Sandia National Laboratories, Livermore, CA, USA, Tech. Rep. (SAND2008-0946 P), Feb. 2008.
- [52] R. Seguin, J. Woyak, D. Costyk, J. Hambrick, and B. Mather, "High-penetration PV integration handbook for distribution engineers," National Renewable Energy Laboratory, Golden, CO, USA, Tech. Rep. (NREL/TP-5D00-63114), Jan. 2016.
- [53] B. Zhao, Z. Xu, C. Xu, C. Wang, and F. Lin, "Network partition based zonal voltage control for distribution networks with distributed PV systems," *IEEE Trans. Smart Grid*, to be published.
- [54] Y. Hong, S. N. Pham, T. Yoo, K. Chae, K. H. Baek, and Y. S. Kim, "Efficient maximum power point tracking for a distributed PV system under rapidly changing environmental conditions," *IEEE Trans. Power Electron.*, vol. 30, no. 8, pp. 4209–4218, Aug. 2015.
- [55] M. J. E. Alam, K. M. Muttaqi, and D. Sutanto, "Mitigation of rooftop solar PV impacts and evening peak support by managing available capacity of distributed energy storage systems," *IEEE Trans. Power Syst.*, vol. 28, no. 4, pp. 3874–3884, Nov. 2013.
- [56] T. Miyagawa et al., "Cooperative control of reactive power of distributed PV systems to suppress voltage of distribution line along railroad track," in *Proc. EPE ECCE-Eur.*, 2015, pp. 1–7.
- [57] J. Seuss, M. J. Reno, M. Lave, R. J. Broderick, and S. Grijalva, "Advanced inverter controls to dispatch distributed PV systems," in *Proc. PVSC*, 2016, pp. 1387–1392.
- [58] H. Kobayashi, "Fault ride through requirements and measures of distributed PV systems in Japan," in *Proc. IEEE PES General Meeting*, Jul. 2012, pp. 1–6.
- [59] A. Sangwongwanich, Y. Yang, and F. Blaabjerg, "High-performance constant power generation in grid-connected PV systems," *IEEE Trans. Power Electron.*, vol. 31, no. 3, pp. 1822–1825, Mar. 2016.
- [60] A. Sangwongwanich, Y. Yang, and F. Blaabjerg, "A sensorless power reserve control strategy for two-stage grid-connected PV systems," *IEEE Trans. Power Electron.*, to be published.
- [61] "TR 3.2.5 for wind power plants above 11 kW," Energinet.dk, Erritsø, Denmark, Tech. Rep. (13/96336-43), Jul. 2016. [Online]. Available: <http://www.energinet.dk/>
- [62] "TR 3.2.2 for PV power plants above 11 kW," Energinet.dk, Erritsø, Denmark, Tech. Rep. (14/17997-39), Jul. 2016. [Online]. Available: <http://www.energinet.dk/>
- [63] "Technical rule for connecting wind farm to power system," National Standard Committee China, Tech. Rep. (GB/T-19963-2011), Jun. 2012. [Online]. Available: <http://www.sac.gov.cn/>
- [64] *IEEE 929-2000 IEEE Recommended Practice for Utility Interface of Photovoltaic (PV) Systems*, IEEE Standards Association, 2000.
- [65] K. Mentessidi, "The Spanish grid code," presented at the EUROUNMED Workshop, Grid Code Renew. Energies—Integr. Electr. Grid, Jun. 2015.
- [66] G. Ding et al., "Adaptive DC-link voltage control of two-stage photovoltaic inverter during low voltage ride-through operation," *IEEE Trans. Power Electron.*, vol. 31, no. 6, pp. 4182–4194, Jun. 2016.
- [67] M. S. El Moursi, W. Xiao, and J. L. Kirtley, "Fault ride through capability for grid interfacing large scale PV power plants," *IET Generat., Transmiss. Distrib.*, vol. 7, no. 9, pp. 1027–1036, Sep. 2013.
- [68] H. M. Hasanien, "An adaptive control strategy for low voltage ride through capability enhancement of grid-connected photovoltaic power plants," *IEEE Trans. Power Syst.*, vol. 31, no. 4, pp. 3230–3237, Jul. 2016.
- [69] G. Petrone, G. Spagnuolo, R. Teodorescu, M. Veerachary, and M. Vitelli, "Reliability issues in photovoltaic power processing systems," *IEEE Trans. Ind. Electron.*, vol. 55, no. 7, pp. 2569–2580, Jul. 2008.
- [70] H. Gao, Y. Chen, Y. Xu, and C. C. Liu, "Resilience-oriented critical load restoration using microgrids in distribution systems," *IEEE Trans. Smart Grid*, vol. 7, no. 6, pp. 2837–2848, Nov. 2016.
- [71] Y. Wang, C. Chen, J. Wang, and R. Baldick, "Research on resilience of power systems under natural disasters—A review," *IEEE Trans. Power Syst.*, vol. 31, no. 2, pp. 1604–1613, Mar. 2016.
- [72] A. Gholami, F. Aminifar, and M. Shahidepour, "Front lines against the darkness: Enhancing the resilience of the electricity grid through microgrid facilities," *IEEE Electrific. Mag.*, vol. 4, no. 1, pp. 18–24, Mar. 2016.
- [73] M. Panteli and P. Mancarella, "The grid: Stronger, bigger, smarter?: Presenting a conceptual framework of power system resilience," *IEEE Power Energy Mag.*, vol. 13, no. 3, pp. 58–66, May 2015.
- [74] T. Gözel and M. H. Hocaoglu, "An analytical method for the sizing and siting of distributed generators in radial systems," *Electr. Power Syst. Res.*, vol. 79, no. 6, pp. 912–918, 2009.
- [75] J. D. Glover, M. S. Sarma, and T. J. Overbye, *Power System Analysis and Design*, 4th ed. New York, NY, USA: Cengage Learn., 2010.
- [76] C. L. Moreira, F. O. Resende, and J. A. P. Lopes, "Using low voltage microgrids for service restoration," *IEEE Trans. Power Syst.*, vol. 22, no. 1, pp. 395–403, Feb. 2007.
- [77] T. T. H. Pham, Y. Besanger, and N. Hadjsaid, "New challenges in power system restoration with large scale of dispersed generation insertion," *IEEE Trans. Power Syst.*, vol. 24, no. 1, pp. 398–405, Feb. 2009.
- [78] J. Li, X.-Y. Ma, C.-C. Liu, and K. P. Schneider, "Distribution system restoration with microgrids using spanning tree search," *IEEE Trans. Power Syst.*, vol. 29, no. 6, pp. 3021–3029, Nov. 2014.
- [79] F. O. Resende, N. J. Gil, and J. A. P. Lopes, "Service restoration on distribution systems using Multi-MicroGrids," *Eur. Trans. Electr. Power*, vol. 21, no. 2, pp. 1327–1342, Mar. 2011.
- [80] J. M. Solanki, S. Khusalani, and N. N. Schulz, "A multi-agent solution to distribution systems restoration," *IEEE Trans. Power Syst.*, vol. 22, no. 3, pp. 1026–1034, Aug. 2007.
- [81] C. P. Nguyen and A. J. Flueck, "Agent based restoration with distributed energy storage support in smart grids," *IEEE Trans. Smart Grid*, vol. 3, no. 2, pp. 1029–1038, Jun. 2012.
- [82] Z. Wang and J. Wang, "Self-healing resilient distribution systems based on sectionalization into microgrids," *IEEE Trans. Power Syst.*, vol. 30, no. 6, pp. 3139–3149, Nov. 2015.
- [83] J. Li, X.-Y. Ma, C.-C. Liu, and K. P. Schneider, "Distribution System Restoration With Microgrids Using Spanning Tree Search," *IEEE Trans. Power Syst.*, vol. 29, no. 6, pp. 3021–3029, Nov. 2014.
- [84] J. D. Glover, M. S. Sarma, and T. J. Overbye, *Power System Analysis and Design*, 4th ed. New York, NY, USA: Cengage Learn., 2010.
- [85] Y. Tian, T. Lin, M. Zhang, and X. Xu, "A new strategy of distribution system service restoration using distributed generation," in *Proc. SUPERGEN*, Apr. 2009, pp. 1–5.
- [86] Y. Xu, C. Liu, K. Schneider, F. Tuffner, and D. Ton, "Microgrids for Service Restoration to Critical Load in a Resilient Distribution System," *IEEE Trans. Smart Grid*, to be published.
- [87] S. Thale and V. Agarwal, "A smart control strategy for the black start of a microgrid based on PV and other auxiliary sources under islanded condition," in *Proc. PVSC*, 2011, pp. 2454–2459.
- [88] M. Soshinkaya, W. H. J. Crijns-Graus, J. M. Guerrero, and J. C. Vasquez, "Microgrids: Experiences, barriers and success factors," *Renew. Sustain. Energy Rev.*, vol. 40, pp. 659–672, Dec. 2014.
- [89] N. K. Choudhary, S. R. Mohanty, and R. K. Singh, "A review on microgrid protection," in *Proc. IEECON*, 2014, pp. 1–4.
- [90] H. Al-Nasseri, M. A. Redfern, and F. Li, "A voltage based protection for micro-grids containing power electronic converters," in *Proc. IEEE PES General Meeting*, Jun. 2006, pp. 1–7.
- [91] D. Q. Hung and N. Mithulananthan, "Multiple distributed generator placement in primary distribution networks for loss reduction," *IEEE Trans. Ind. Electron.*, vol. 60, no. 4, pp. 1700–1708, Apr. 2013.
- [92] M. A. Kashem and G. Ledwich, "Impact of distributed generation on protection of single wire earth return lines," *Electr. Power Syst. Res.*, vol. 62, no. 1, pp. 67–80, 2002.
- [93] B. Hussain, S. M. Sharkh, S. Hussain, and M. A. Abusara, "Integration of distributed generation into the grid: Protection challenges and solutions," in *Proc. IET DPS*, 2010, pp. 1–5.
- [94] L. Kumpulainen and K. Kauhaniemi, "Analysis of the impact of distributed generation on automatic reclosing," in *Proc. PSCE*, 2004, pp. 10–13.

- [95] M. Geidl, "Protection of power systems with distributed generation-state of the art," Ph.D. dissertation, Power Syst. Lab., Swiss Federal Inst. Technol. (ETH), Zürich, Switzerland, 2005.
- [96] M. Brucoli and T. C. Green, "Fault behaviour in islanded microgrids," in *Proc. CIRED*, 2007, pp. 21–24.
- [97] H. Al-Nasser, M. A. Redfern, and F. Li, "A voltage based protection for micro-grids containing power electronic converters," in *Proc. IEEE PES General Meeting*, Jun. 2006, pp. 1–7.
- [98] C. Hou and X. Hu, "A study of voltage detection based fault judgement method in micro-grid with inverter interfaced power source," in *Proc. Int. Conf. Electr. Eng.*, 2009, pp. 1–5.
- [99] T. Loix, T. Wijnhoven, and G. Deconinck, "Protection of microgrids with a high penetration of inverter-coupled energy sources," in *Proc. IEEE PES/CIGRE Symp.*, Jul. 2009, pp. 1–6.
- [100] A. R. Bergen, *Power System Analysis*. Englewood Cliffs, NJ, USA: Prentice-Hall, 1986.
- [101] H. Nikkhajoei and R. H. Lasseter (Dec. 2006). *Microgrid Fault Protection Based on Symmetrical and Differential Current Components*. [Online]. Available: <http://www.energy.ca.gov/2009publications/CEC-500-2009-004/CEC-500-2009-004-APP.PDF>
- [102] S. M. Mirsaeidi, D. W. Said, M. H. Mustafa, M. Habibuddin, and K. Ghaffari, "Review and analysis of existing protection strategies for micro-grids," *J. Electr. Syst.*, vol. 10, no. 1, pp. 1–10, 2014.
- [103] E. Sortomme, S. S. Venkata, and J. Mitra, "Microgrid protection using communication assisted digital relays," *IEEE Trans. Power Del.*, vol. 25, no. 4, pp. 2789–2796, Oct. 2010.
- [104] L. Bin, L. Yongli, B. Zhiqian, and A. Klimek, "Design of protection and control scheme for microgrid systems," in *Proc. UPEC*, 2009, pp. 1–5.
- [105] G. Buigues, A. Dysco, V. Valverde, I. Zamora, and E. Fernandez, "Microgrid protection: Technical challenges and existing techniques," *Renew. Energy Power Quality J.*, vol. 6, no. 11, pp. 222–227, 2013.
- [106] H. Lin, C. Liu, J. M. Guerrero, and J. C. V. Quintero, "Distance protection for microgrids in distribution system," in *Proc. IECON*, 2015, pp. 731–736.
- [107] H. H. Zeineldin, E. F. El-Saadany, and M. M. A. Salama, "Distributed generation micro-grid operation: Control and protection," in *Proc. PSC*, 2006, pp. 105–111.
- [108] E. Sortomme, S. S. Venkata, and J. Mitra, "Microgrid protection using communication assisted digital relays," *IEEE Trans. Power Del.*, vol. 25, no. 4, pp. 2789–2796, Oct. 2010.
- [109] S. Kar, S. R. Samantaray, and M. D. Zadeh, "Data-mining model based intelligent differential microgrid protection scheme," *IEEE Syst. J.*, to be published.
- [110] E. Sortomme, J. Ren, and S. S. Venkata, "A differential zone protection scheme for microgrids," in *Proc. IEEE PES General Meeting*, Jul. 2013, pp. 1–5.
- [111] M. Dewadasa, R. Majumder, A. Ghosh, and G. Ledwich, "Control and Protection of a Microgrid with Converter Interfaced Micro Sources," in *Proc. ICPS*, 2009, pp. 1–6.
- [112] M. Dewadasa, "Protection for distributed generation interfaced networks, Electrical Engineering," Ph.D. dissertation, Faculty Built Environ. Eng., Queensland Univ. Technol., Brisbane, QL, Australia, 2010.
- [113] W. Huang, N. Tai, X. Zheng, C. Fan, X. Yang, and B. J. Kirby, "An impedance protection scheme for feeders of active distribution networks," *IEEE Trans. Power Del.*, vol. 29, no. 4, pp. 1591–1602, Aug. 2014.
- [114] S. Voima and K. Kauhaniemi, "Using distance protection in smart grid environment," in *Proc. IEEE PES Innov. Smart Grid Technol.*, Oct. 2014, pp. 1–6.
- [115] M. R. Miveh, M. Gandomkar, S. Mirsaeidi, and M. R. Gharibdoost, "A review on protection challenges in microgrids," in *Proc. EPDC*, 2012, pp. 1–5.
- [116] Y. Han, X. Hu, and D. Zhang, "Study of adaptive fault current algorithm for microgrid dominated by inverter based distributed generators," in *Proc. PEDG*, 2010, pp. 852–854.
- [117] K. Dang, X. He, D. Bi, and C. Feng, "An adaptive protection method for the inverter dominated microgrid," in *Proc. ICEMS*, 2011, pp. 1–5.
- [118] M. Khederzadeh, "Adaptive setting of protective relays in microgrids in grid-connected and autonomous operation," in *Proc. IET DPSP*, 2012, pp. 1–4.
- [119] N. Schaefer, T. Degner, A. Shustov, T. Keil, and J. Jaeger, "Adaptive protection system for distribution networks with distributed energy resources," in *Proc. IET DPSP*, 2010, pp. 1–5.
- [120] H. Laaksonen, D. Ishchenko, and A. Oudalov, "Adaptive protection and microgrid control design for Hailuoto island," *IEEE Trans. Smart Grid*, vol. 5, no. 3, pp. 1486–1493, May 2014.
- [121] A. Oudalov and A. Fidigatti, "Adaptive network protection in microgrids," *Int. J. Distrib. Energy Resour.*, vol. 5, no. 3, pp. 201–226, 2009.
- [122] N. Jayawarna, C. Jones, M. Barnes, and N. Jenkins, "Operating microgrid energy storage control during network faults," in *Proc. IEEE Int. Conf. Syst. Syst. Eng. SoSE*, Apr. 2007, pp. 1–7.
- [123] F. van Overbeke, "Fault current source to ensure the fault level in inverter-dominated networks," in *Proc. CIRED*, 2009, pp. 1–4.

## ABOUT THE AUTHORS

**Frede Blaabjerg** (Fellow, IEEE) received the Ph.D. degree in electrical engineering from Aalborg University, Aalborg, Denmark, in 1995.

He was with ABB-Scandia, Randers, Denmark, from 1987 to 1988. He became an Assistant Professor in 1992, Associate Professor in 1996, and Full Professor of power electronics and drives in 1998 at Aalborg University. His current research interests include power electronics and its applications such as in wind turbines, PV systems, reliability engineering, power quality, and adjustable speed drives.

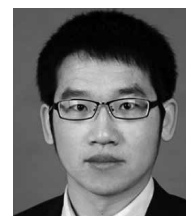
Prof. Blaabjerg has received 18 IEEE Prize Paper Awards, the IEEE PELS Distinguished Service Award in 2009, the EPE-PEMC Council Award in 2010, the IEEE William E. Newell Power Electronics Award 2014 as well as the Villum Kann Rasmussen Research Award 2014. He was the Editor-in-Chief of the IEEE TRANSACTIONS ON POWER ELECTRONICS from 2006 to 2012. He was nominated by Thomson Reuters as one of the 250 most cited researchers in engineering in the world in 2014, 2015, and 2016. In 2017, he became Doctor Honoris Causa at the University of Politehnica, Timisoara, Romania.



**Yongheng Yang** (Member, IEEE) received the B.Eng. degree in electrical engineering and automation from Northwestern Polytechnical University, Shaanxi, China, in 2009 and the Ph.D. degree in electrical engineering from Aalborg University, Aalborg, Denmark, in 2014.

He was a postgraduate student with Southeast University, Jiangsu, China, from 2009 to 2011. In 2013, he was a Visiting Scholar at Texas A&M University, College Station, TX, USA. Since 2014, he has been with the Department of Energy Technology, Aalborg University, where currently he is an Assistant Professor. He has published more than 100 technical papers and coauthored a book *Periodic Control of Power Electronic Converters* (London, UK: IET). His research includes grid integration of renewable energies, power electronic converter design, analysis and control, and reliability in power electronics.

Dr. Yang is a Member of the IEEE Power Electronics Society (PELS) Students and Young Professionals Committee. He served as a Guest Associate Editor of IEEE JOURNAL OF EMERGING AND SELECTED TOPICS IN POWER ELECTRONICS and a Guest Editor of *Applied Sciences*. He is an Associate Editor of CPSS TRANSACTIONS ON POWER ELECTRONICS AND APPLICATIONS.



**Dongsheng Yang** (Member, IEEE) was born in Jiangsu Province, China, in 1984. He received the B.S., M.S., and Ph.D. degrees in electrical engineering from Nanjing University of Aeronautics and Astronautics (NUAA), Nanjing, China, in 2008, 2011, and 2016, respectively.

Since 2016, he has been with Aalborg University, Aalborg, Denmark, where he is currently a Postdoctoral Researcher in the Department of Energy Technology. His main research interests include design and control of grid-connected inverters, harmonic analysis and mitigation of power-electronic-based power systems, and online impedance measurement techniques.



in the Department of Energy Technology. His research interests include modeling and control of grid-connected converters, harmonics analysis and control, passive and active filters, and stability of power-electronic-based power systems.

Dr. Wang serves as an Associate Editor for the IEEE TRANSACTIONS ON POWER ELECTRONICS, the IEEE TRANSACTIONS ON INDUSTRY APPLICATIONS, and the IEEE JOURNAL OF EMERGING AND SELECTED TOPICS IN POWER ELECTRONICS. He received the second prize paper award and the outstanding reviewer award of the IEEE TRANSACTIONS ON POWER ELECTRONICS in 2014 and 2016, respectively, and the best paper award at IEEE PEDG 2016.

**Xiongfei Wang** (Member, IEEE) received the B.S. degree from Yanshan University, Qinhuangdao, China, in 2006, the M.S. degree from Harbin Institute of Technology, Harbin, China, in 2008, both in electrical engineering, and the Ph.D. degree in energy technology from Aalborg University, Aalborg, Denmark, in 2013.

Since 2009, he has been with Aalborg University, where he is currently an Associate Professor

